



USER MANUAL

Dishwasher

EN

DWC6432FIXXLU

Contents

Your dishwasher	3	Unloading the dishwasher	24
Important safety instructions	4	Program chart	25
FCC declaration of conformity	4	ASKO Connect Pro & ConnectLife	26
FCC radiation exposure statement	4	ASKO Connect Pro	26
General	4	ConnectLife	26
Child safety	5	Remote control the dishwasher	26
Sani lock	5	Remote start the dishwasher	26
Lock	5	Settings	28
Installation	5	Care and maintenance instructions	34
Overflow guard	5	Add rinse aid	34
Packing material	6	Add salt	34
Winter storage/Transport	6	Add auto dose	34
End-of-service appliance recycling	6	Clean the filters	34
Before washing for the first time	7	Cleaning the spray arms	36
Water hardness	7	Clean the outside of the dishwasher	37
Basic settings	7	Run Self-cleaning	37
Add rinse aid	10	Remove blockages	37
Add salt	10	Troubleshooting	39
Automatic dosing	11	General	40
Greener dishwashing	12	WiFi	46
Save energy and water	12	Installation instructions	48
Loading the dishwasher	13	Important safety instructions	48
Fragile dishes	13	Setup	49
Loading affects the results	13	Connection to an automatic dosing system	50
The dishwasher's baskets	13	Drain connection	53
Top cutlery tray	14	Connection to water supply	53
Upper basket	15	Electrical connection	54
Lower basket	16	Push to open	55
Cutlery basket	17	Service and warranty	56
Typical load	18	Limited Warranty – Residential and Professional Appliances	56
Using the dishwasher	19	Items excluded from warranty	56
Add detergent	19	Disclaimer	57
On/Standby mode	20	ASKO Customer Care	57
Select program	20	Service after expiration of limited warranty ...	57
Start/Stop	21	Number of cycles	57
Status light floor projection	22	Technical information	58
If you want to load more dishes	22	Technical data	58
Power failure	23	Electrical connection	58
Once the program has finished	23		
The best drying results	24		

Your dishwasher

Welcome to our growing ASKO family!

We are proud of our appliances. We hope that this appliance will be an appreciated and dependable device for many years to come.

Please read the operating instructions before use. They include general tips, information about the settings and adjustments you can make, and the best way to take care of your appliance.

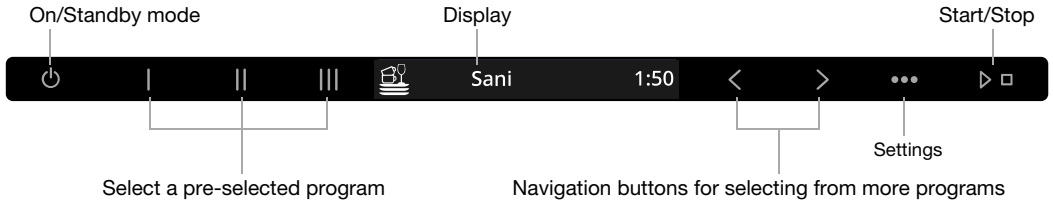

Symbols on the display:

- Automatic door opening
- Add rinse aid
- Add salt
- Auto dose
- Add auto dose

- WiFi status Connected (Flashes when connecting)
- Remote control active

Text on the display:

- Clean the filters
- Run Self-cleaning
- See the *chapter Care and maintenance instructions*.

Install the dishwasher; see the chapter *Installation instructions*. Then open the door and press .

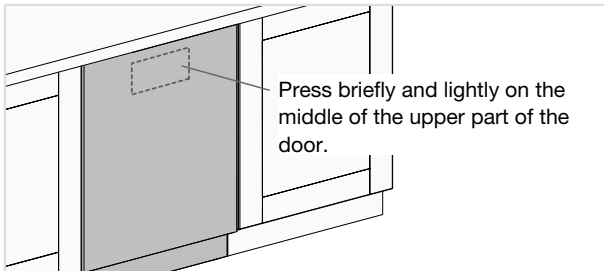

Press briefly and lightly on the middle of the upper part of the door.

"Welcome to your new ASKO dishwasher. This is a first time setup." is shown on the display the first time the dishwasher is switched on. It is important that you choose the right settings to ensure good dishwashing results. See page 7.

The dishwasher can be connected to one or more systems for the automatic dosing of commercial detergent and rinse aid, which simplifies everyday operation and reduces the risk of overdosing.

ASKO Connect Pro is a web-based platform that enables you to organize, manage and monitor all your professional ASKO appliances regardless of where they are installed. Once you have connected a professional appliance in the ConnectLife app, a link to ASKO Connect Pro is shown. For more information, please see <https://us.asko.com/professional>.

Important safety instructions

SAVE THESE INSTRUCTIONS FOR FUTURE REFERENCE

WARNING!

When using your dishwasher, follow basic precautions, including the following:

- Read all instructions before using the dishwasher.
- Use the dishwasher only for its intended purpose.
- Use only detergents or rinse agents recommended for use in a dishwasher and keep them out of the reach of children.
- When loading items to be washed:
 - position sharp items so that they are not likely to damage the door seal, and
 - load sharp knives with the handles up to reduce the risk of cut-type injuries.
- Do not wash plastic items unless they are marked “dishwasher safe” or the equivalent. For plastic items not so marked, check the manufacturer’s recommendations.
- Do not operate the dishwasher unless all enclosure panels are properly in place.
- Do not tamper with controls.
- Do not abuse, sit on, or stand on the door or dish rack of the dishwasher.
- To reduce the risk of injury, do not allow children to play in or on a dishwasher.
- Under certain conditions, hydrogen gas may be produced in a hot water system that has not been used for two weeks or more. HYDROGEN GAS IS EXPLOSIVE. If the hot water system has not been used for two weeks, before using the dishwasher turn on all hot water faucets and let the water flow from each for several minutes. This will release any accumulated hydrogen gas. As the gas is flammable, do not smoke or use an open flame during this time.
- Remove the door of the dishwasher when removing the dishwasher from service or discarding it (so that children cannot become trapped inside).
- Read the grounding instructions in the installation instructions.

FCC declaration of conformity

This device complies with part 15 of the FCC Rules. Operation is subject to the condition that this device does not cause harmful interference.

FCC radiation exposure statement

This equipment complies with FCC radiation exposure limits set forth for an uncontrolled environment. This equipment should be installed and operated with a minimum distance of 8” (20 cm) between the radiator and your body.

General

- Do not run the dishwasher while you are out of the home.
- Do not store or use combustible materials, gasoline, or other flammable vapors and liquids in the vicinity of this or any other appliance.
- Disconnect electrical power to dishwasher before servicing.
- Repairs should be done by a qualified technician.

NSF/ANSI 184 certified residential dishwashers are not intended for licensed food establishments.

Important safety instructions

WARNING!

Only Sanitize NSF cycles have been designed to meet the requirements of NSF/ANSI 184 for soil removal and sanitization efficacy. There is no assurance, either directly or indirectly, that all cycles on a certified machine have passed the sanitization performance test.

WARNING!

PROPOSITION 65 FOR CALIFORNIA RESIDENTS

Cancer and Reproductive Harm – www.P65Warnings.ca.gov

Child safety

- Always keep small children away from the machine when it is open. There may be some detergent residue left inside the machine.
- Always close the door and start the dishwasher as soon as you put in the detergent.
- If dishwasher detergent gets in someone's eyes, rinse them with plenty of water for at least 15 minutes.
- Should a child swallow dishwasher detergent or rinse aid, give plenty to drink immediately, i.e., one or two glasses of milk or water. Do not try to induce vomiting. Seek medical advice immediately: Call the National Poison Control Center at 1-800-222-1222.

WARNING!

Dishwasher detergents and rinse aids are corrosive, so always keep them out of reach of children.

Sani lock

To prevent the risk of burn injuries, the door cannot be opened while the temperature inside the dishwasher exceeds 149 °F / 65 °C.

Lock

You can activate the Lock setting to prevent children or persons with reduced mental capabilities from starting the dishwasher. See the chapter *Settings*. You can temporarily deactivate the Lock function – place your foot over the status light floor projection and open the dishwasher door with the Push to open function.

Installation

See the chapter *Installation instructions*.

Overflow guard

The overflow guard starts pumping out the water and turns off the water supply if the water level in the dishwasher exceeds the normal level. If the overflow guard is triggered, F54 (Overfilling water) appears on the display. Turn off the water supply valve and contact your nearest Customer Care

Important safety instructions

Center. (To avoid water leakage outside the dishwasher, do not remove the plug from the power outlet until the water supply valve has been turned off!)

Packing material

The outer packaging protects the appliance during transport. The packaging material is recyclable. Separate the different packaging materials to help reduce raw material use and waste. Your dealer can take the packaging or direct you to the nearest recycling center. The packaging is comprised of:

- Corrugated cardboard made from up to 100% recycled material.
- Expanded polystyrene (EPS) with no added chlorine or fluorine.
- Supports made from untreated wood.
- Protective plastic made from polyethylene (PE).

Winter storage/Transport

Store the dishwasher above freezing temperature and avoid long transport distances in very cold weather. Transport the dishwasher upright or lying on its back. Before transporting a used dishwasher, or before prolonged storage, water must first be removed from the machine.

Handle the front corners of the dishwasher with care so that they do not get bent, which can affect door opening.

End-of-service appliance recycling

When the dishwasher has reached the end of its service life and is to be disposed of, it is important to make it unusable (to prevent accidents and facilitate recycling). Pull out the power cable and cut it as short as possible. If you have any questions about where and how your dishwasher should be correctly recycled, contact your local authority.



Recycle as electrical waste.

NOTE!

Follow the instructions carefully to avoid injury to persons and damage to property, and to maintain the warranty.

Before washing for the first time

Water hardness

In order to achieve good dishwashing results, the dishwasher needs soft water (water with low mineral content). Hard water leaves a white coating on dishes and the dishwasher.

Checking water hardness

Water hardness is specified using German degrees of water hardness (°dH), French degrees of water hardness (°fH), English degrees of water hardness (°eH), millimoles per liter (mmol/l), or grains per gallon (gr/gal).

A water supply with a water hardness in excess of 5°dH (9°fH / 6°eH / 0.9 mmol/l / 5.9 gr/gal) must be softened. This is done automatically with the aid of the built-in water softener. In order for the water softener to function properly, its settings must be adjusted to the hardness of the water supply. Once you have adjusted the water softener settings, add detergent and rinse aid in doses suitable for soft water.

Contact the local water utility to check the water hardness in your area.

Make a note of the water hardness: _____

German water hardness scale	French water hardness scale	Recommended setting
0-3°dH	0-5°fH	0 (Default)
4-5°dH	6-9°fH	1
6-8°dH	10-14°fH	2
9-11°dH	15-20°fH	3
12-14°dH	21-25°fH	4
15-19°dH	26-34°fH	5
20-24°dH	35-43°fH	6
25-29°dH	44-52°fH	7
30-39°dH	53-70°fH	8
40°dH	71°fH	9

If the water hardness exceeds 20°dH (36°fH), we recommend connecting an external water softener.

WARNING!

Hard water leaves a white coating on dishes and inside the dishwasher. It is therefore important that you select the right setting for the water softener. See Water hardness.

Never run the dishwasher with an empty salt compartment if the water supply has a water hardness in excess of 5°dH (9°fH / 6°eH / 0.9 mmol/l / 5.9 gr/gal).

Basic settings

Open the door. Press .

"Welcome to your new ASKO dishwasher. This is a first time setup." is shown on the display. It is important that you choose the right settings to ensure good dishwashing results.

Before washing for the first time

Select setting with < or >. Confirm selected setting with ●●●.

Settings	
Language	Select the language to be shown on the display.
Power 15 A/20 A <i>Default: 20 A</i>	<p>This dishwasher has been designed to be able to be connected to an electrical supply network with fuses for 15 A (120 V) or 20 A (208-240 V).</p> <p>The water in the dishwasher will be heated more quickly, and the dishwashing program will run more quickly, if you select 20 A.</p> <p>Select 15 A or 20 A according to the electrical supply network in your property.</p>
Rinse aid 0/1/2/3/4/5 ¹⁾ <i>Default: 4</i>	<p>Use rinse aid to improve wash and dry times. Also use rinse aid to achieve clear and spotless results.</p> <p>The rinse aid dispenser can be adjusted between 0 (Off) and 5 (High dosage).</p>
Water hardness 0/1/2/3/4/5/6/7/8/9 <i>Default: 0</i>	<p>Adjusting the water softener. Select a setting depending on the hardness of the water supply. It is important that this setting is correct.</p> <p>For a water supply with a hardness above 5°dH (9°FH / 6°eH / 0.9 mmol/l / 5.9 gr/gal), fill with salt.</p> <p>For a water supply with a hardness below 6°dH (10°FH / 7°eH / 1.0 mmol/l / 6.0 gr/gal), select 0. The water softener is deactivated and no salt needs to be added.</p>
TAB On/Off (All-in-one detergent) <i>Default: Off</i>	<p>Activate this setting when using an all-in-one detergent that contains rinse aid.</p> <p><i>This setting reduces the rinse aid dosage and affects how often the dishwasher's built-in softener is regenerated.</i></p>
WiFi WiFi status	Connect the dishwasher to your wireless network to be able to remote control the dishwasher using the <i>ConnectLife</i> app.
WiFi connection On/Off	After connecting the dishwasher to your local network, you can select <i>WiFi connection Off</i> to deactivate the connection. Select <i>WiFi connection On</i> to reconnect to the same network.
Connection setup	<p>Connect the dishwasher to your wireless network and pair with your smartphone/tablet.</p> <ul style="list-style-type: none"> In the <i>ConnectLife</i> app, go to the »Add devices« menu and select the appropriate device type. Then scan the QR code (it can be found on the appliance's serial number plate). Select <i>Connection setup</i>.
Add device	<p>Pair more devices/users with the dishwasher.</p> <ul style="list-style-type: none"> In the <i>ConnectLife</i> app, go to the »Add devices« menu and select the appropriate device type. Then scan the

Before washing for the first time

Settings	
	QR code (it can be found on the appliance's serial number plate). <ul style="list-style-type: none">• Select <i>Add device</i>.
Remove all devices	Select <i>Remove all devices</i> to remove all connected devices/users.
WiFi factory reset	Select <i>WiFi factory reset</i> to restore the default factory settings.
Exit	Select <i>Exit</i> and press ••• to exit the menu for WiFi.
Save and exit	Select <i>Save and exit</i> , press ••• .

¹⁾ The setting will be deactivated following the activation of automatic dosing of the commercial rinse aid. Rinse aid will not then need to be refilled.

To change the chosen setting, see the chapter *Settings*.

Before washing for the first time

* Add rinse aid

Add rinse aid to the container for rinse aid (if the dishwasher has not been connected to a system for the automatic dosing of rinse aid).

Fill up the rinse aid compartment with rinse aid if you have selected Rinse aid 1 - 5.

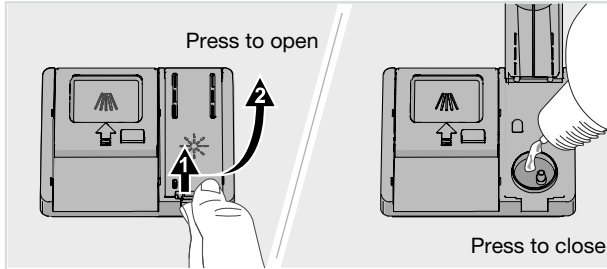

1. Open the rinse aid compartment lid.
2. Carefully fill up with rinse aid to the level marked **MAX**.
3. Wipe up any spilled rinse aid around the compartment.
4. Close the lid firmly.

⌘ Add salt

For a water supply with a hardness above 5°dH (9°FH / 6°eH / 0.9 mmol/l / 5.9 gr/gal), fill with salt.

Add salt to the salt compartment if you have selected Water hardness 1 - 9.

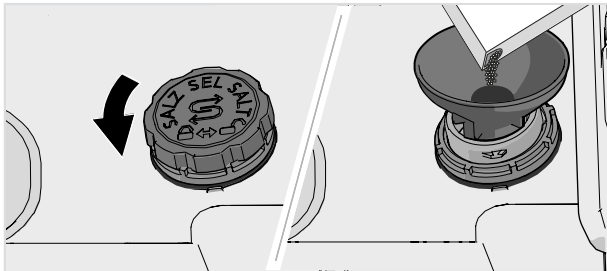

1. Remove the salt compartment lid by turning it counterclockwise.
2. Place the funnel supplied with the dishwasher in the salt compartment top-up hole. Before washing for the first time, pour in about 0.3 gal (1 l) of water. (Water is only needed the first time.)
3. Add enough salt to fill the salt compartment (max. 750 gram (26 oz)). Use special dishwasher salt.
4. Wipe off excess salt and turn the lid clockwise to the closed position.

In order to avoid rust stains, a dishwashing program must be started immediately after adding salt.

WARNING!

Never pour dishwasher detergent into the salt compartment. This destroys the water softener!

Automatic dosing

The dishwasher can be connected to one or more systems for the automatic dosing of commercial detergent and rinse aid, which simplifies everyday operation and reduces the risk of overdosing.

Step by step

- Connect the external cables for the automatic dosing of commercial detergent and rinse aid. Also connect the hoses supplied. See the *Installation instructions* chapter.
- Activate Auto dose in the dishwasher menu for Settings. See the chapter *Settings*.
- Add commercial detergent and rinse aid intended for automatic dosing to the appropriate external compartments.
- Select Vent the hose to dispense detergent and rinse aid. See the chapter *Settings*.

Diluting detergent and rinse aid

To correctly dilute detergent and rinse aid, calculate the dose based on the amount of water in the machine.

Amount of water in the machine:

- 3.5 gallon for detergent dose
- 3.5 gallon for rinse aid dose

NOTE!

Add the commercial detergent and rinse aid in the appropriate external containers in advance, to prevent air from entering the system.

WARNING!

Note that there are risks involved in handling commercial detergent and rinse aid. Protective gloves and goggles must be used when handling these products.

Follow the supplier's safety regulations concerning the handling and storage of detergent and rinse aid.

Greener dishwashing

Save energy and water

When using a dishwasher in a residential setting, less energy and water are generally used compared to washing the dishes by hand.

Do not rinse under running water

Do not rinse the dishes under running water as this will lead to increased energy and water consumption. Simply scrape off large food particles before loading the dishwasher.

Choose a green detergent

Read the environmental declaration on the packaging!

Too much detergent, rinse aid and salt can result in less effective dishwashing and lead to a greater environmental impact.

Run a fully loaded dishwasher

Save energy and water by waiting until the dishwasher is full before running a program. Use the Rinse and hold program to rinse the dishes if there are any unpleasant odors.

Run programs at a lower temperature

If the dishes are only lightly soiled, you can select a program with a lower temperature.

Select dishwashing program – Eco

This program is the most effective in terms of energy consumption.

Select setting – Automatic door opening

Better drying results are achieved if you use the Automatic door opening option, which automatically opens the dishwasher door. Wait until the dishwasher indicates that the program has ended and the dishes have cooled before unloading the dishwasher. (If the dishwasher is built-in, the surrounding furnishings must be resistant to any condensation from the dishwasher.)

Fragile dishes

Some cookware is not dishwasher safe. This can be for several reasons. Some materials cannot withstand high temperatures, others can be damaged by dishwasher detergent.

Use caution with, for example, handmade items, China, crystal/glassware, silver, copper, tin, aluminum, wood, and plastic. Look for the "Dishwasher safe" marking.

China

Porcelain with decoration on top of the glazing (the items feel rough) should not be washed in a dishwasher.

Crystal/Glass

Wash fragile items made of crystal/glass using the gentle dishwashing program Crystal. Remember to use a small amount of detergent and to place items so that they do not touch each other during the wash.

Use rinse aid to improve wash and dry times. Also use rinse aid to achieve clear and spotless results.

Hand-painted glassware, as well as antique and very fragile items, should not be washed in a dishwasher.

Silver

Silver and stainless steel items should not come into contact, as the silver can become discolored.

In order to avoid marks and tarnishing, separate dishes made from different metals, such as silver, stainless steel, and aluminum.

Aluminum

Aluminum can lose its shine if washed in a dishwasher. However, good quality aluminum pans can be washed in a dishwasher, even if some of the shine will be lost.

Cutlery with glued handles

Some types of glue are not dishwasher safe. In such cases, the handles may loosen.

Loading affects the results

Load the dishes carefully to ensure the best washing and drying results with the lowest possible energy and water consumption. Give your dishwasher the best chance to reach and clean all surfaces, as well as to dry the dishes as thoroughly as possible.

- All dirty surfaces should face in and down.
- Dishes should not be placed in or on each other.
- Angle dishes with hollows, such as cups, so that the rinse water will run off. This is also important for plastic items.
- Place the upper basket in its highest position when dishwashing very large plates.
- Make sure small items cannot fall through the dishwasher basket; place them in the top cutlery tray.

NOTE!

Check that the spray arms can rotate freely.

The dishwasher's baskets

The dishwasher includes a top cutlery tray, an upper basket, and a lower basket with a cutlery basket.

Loading the dishwasher

The basket appearance may differ depending on the configuration.

Top cutlery tray

The top cutlery tray accommodates cutlery, ladles, whisks, and other utensils.

Avoid placing tall objects in the top cutlery tray. They can block the top spray arm.

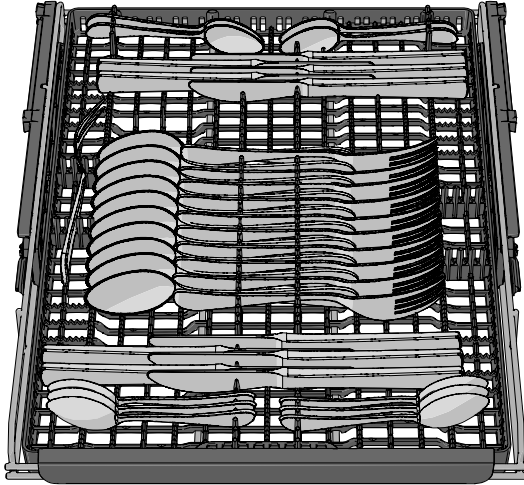

Raising the top cutlery tray

1. Pull out the top cutlery tray.
2. Pull the two locking handles forward on each side to raise the top cutlery tray.

Lowering the top cutlery tray

1. Pull out the top cutlery tray.
2. Slide the two locking handles down and back to lower the top cutlery tray.

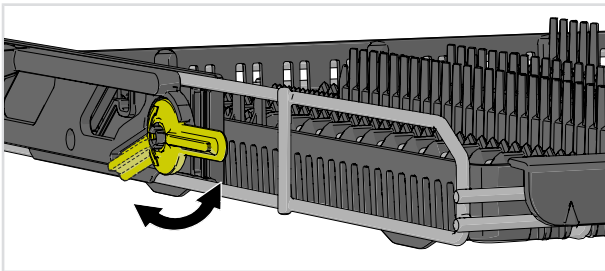

Upper basket

Place glasses, cups, bowls, side plates, and saucers in the upper basket. Place all soiled surfaces face down. Place wine glasses on the wine glass shelf. Place knives in the knife stand on the right.

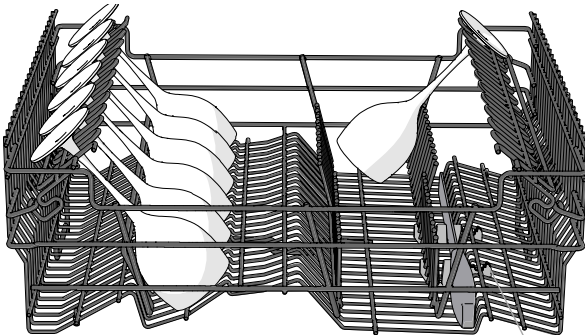
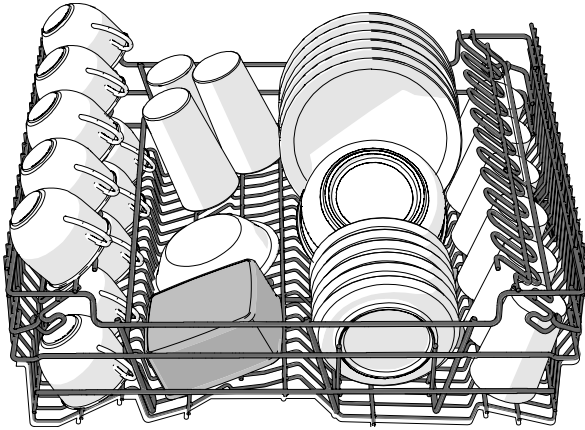

Knife stand

Raising the upper basket

1. Pull out the upper basket.
2. Grab the sides of the upper basket with both hands and lift it up.

Lowering the upper basket

1. Pull out the upper basket.
2. Grab the sides of the upper basket with both hands and push in the two locking handles to lower the upper basket.

Loading the dishwasher

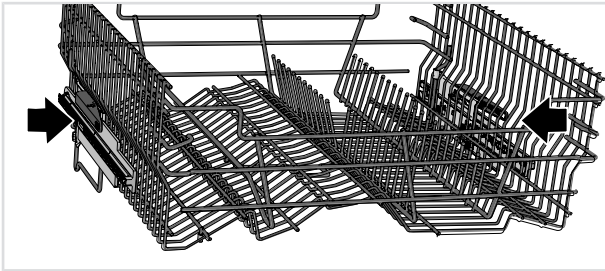

Lower basket

Place plates, side plates, serving dishes, pots, and cutlery (in the cutlery basket) in the lower basket.

Place pots and pans in the rear of the lower basket to best utilize dishwashing performance from the two spray nozzles.

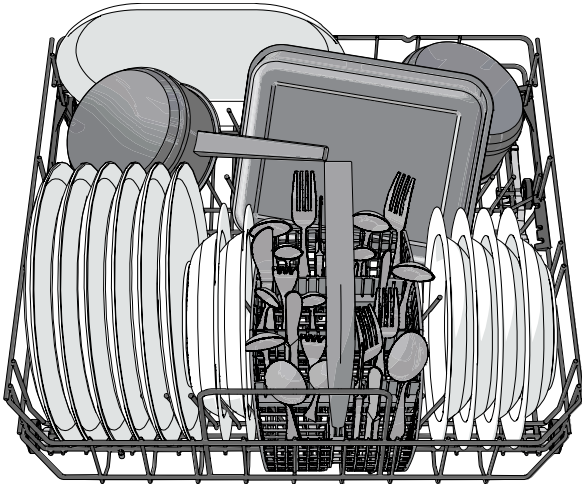

Adjustable plate supports

The adjustable plate supports can be adjusted to suit the dishes. Release the plate supports by pushing them inward before repositioning them. The plate supports can also be folded down to make it easier to load pots and bowls.

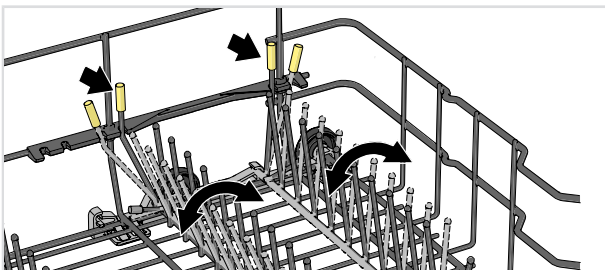

Vase and bottle holder

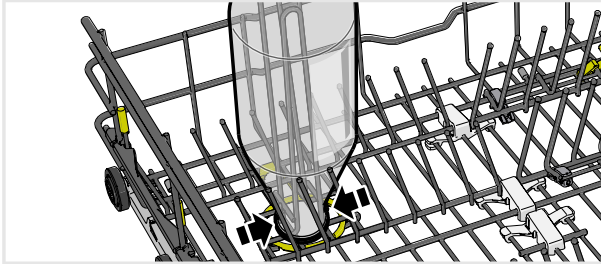

Install the vase and bottle holder above the left spray nozzle. (Found in the enclosed plastic bag.)

Washing large plates

You can adjust the lower basket for plates with a diameter of 9 3/4-13 3/4" (25-35 cm) by moving the adjustable plate supports and their fixtures to increase the distance between the tine rows.

Cutlery basket

Place cutlery with the handles facing down, except for knives, and spread them out as much as possible. Ensure that spoons are not nesting.

The cutlery basket is best placed in the middle at the front of the lower basket to best utilize dishwashing performance from the unique spray zone intended for the cutlery basket.

⚠ WARNING!

Knives and other pointed items must be placed horizontally in the dishwasher's special cutlery baskets.

Fold-down section for small items

The cutlery basket has a fold-down section in the middle for small items or small shafts (such as electric whisk attachments).

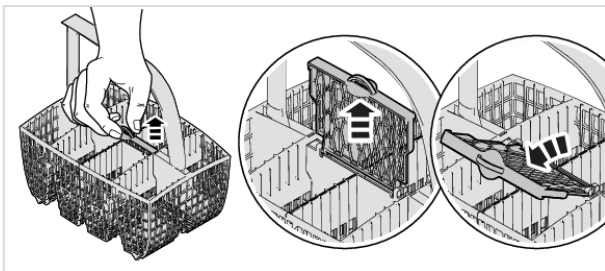

Loading the dishwasher

Typical load

Recommended for daily, regular, or typical use.

Upper basket

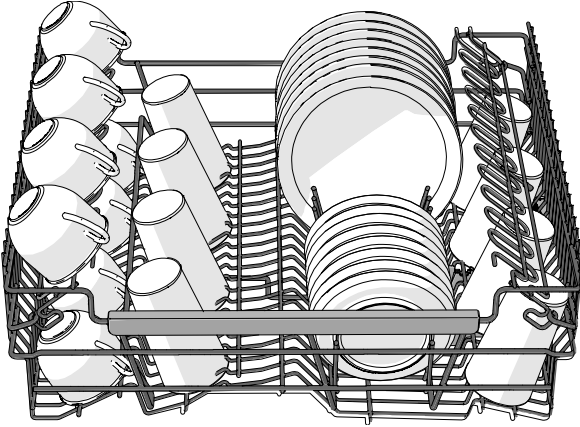

Lower basket

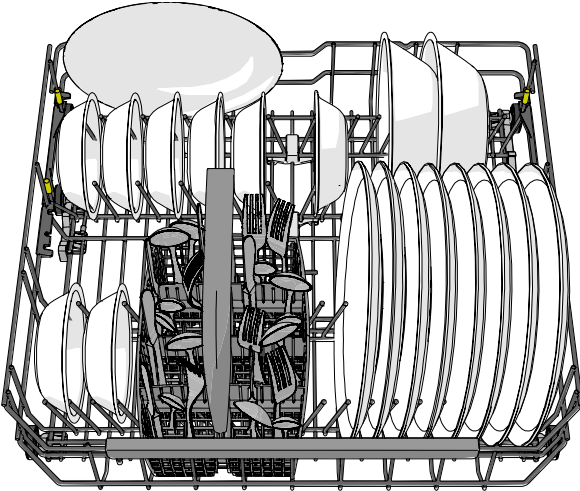

Add detergent

Add detergent to the detergent compartment (if the dishwasher has not been connected to a system for the automatic dosing of commercial detergent).

Follow the instructions on the detergent packaging. This dishwasher is fitted with a water softener, so use detergent and rinse aid doses suitable for soft water.

Detergent compartment

Choose a detergent intended for professional dishwashers to ensure optimal dishwashing results.

Too much detergent can result in less effective dishwashing and lead to greater environmental impact.

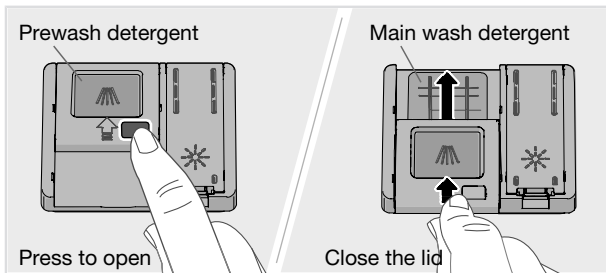

The detergent compartment must be dry when adding detergent. There is one compartment for the prewash and one for the main wash. If dishwasher detergent powder or dishwasher detergent gel is used, you can add a small amount of the detergent to the prewash compartment. If you have questions about the detergent, contact the detergent manufacturer.

NOTE!

Use only dishwasher detergent. Liquid hand-washing detergent must not be used as the foam that forms prevents the dishwasher from operating effectively.

All-in-one detergent

There are many types of all-in-one detergents on the market. Read through the directions for these products carefully.

Activate the TAB setting when using an all-in-one detergent that contains rinse aid.

Dishwasher tablets are not recommended for programs lasting less than 75 minutes. Use dishwasher detergent powder or dishwasher detergent gel instead.

NOTE!

Optimal washing and drying results are achieved by using normal dishwasher detergent together with separately dispensed rinse aid and salt.

Using the dishwasher

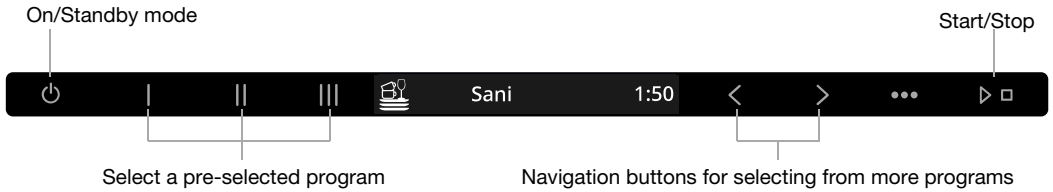

On/Standby mode

Open the door and press . Also turn on the water supply valve if it is turned off.

Select program

To select a program, press I, II or III. You can also select a program by pressing < or > until the desired program is shown on the display.

Select a program to suit the type of dishes and how dirty they are.



Quick

This program is used for glasses and porcelain that is lightly soiled, such as coffee cups.



Sani¹⁾

An ideal program when hygiene demands are set high. The temperature of the main wash is 140 °F / 60 °C. The final rinse is 185 °F / 85 °C for 4 minutes.

 To prevent the risk of burn injuries, the door cannot be opened while the temperature inside the dishwasher exceeds 149 °F / 65 °C.



Sani quick¹⁾

A quick program when hygiene demands are high. The temperature of the main wash is 122 °F / 50 °C. The final rinse is 185 °F / 85 °C for 4 minutes.

 To prevent the risk of burn injuries, the door cannot be opened while the temperature inside the dishwasher exceeds 149 °F / 65 °C.



Sanitize NSF¹⁾

A hygiene program that ensures good dishwashing results for dishes with dried-on food residue. The temperature of the main wash is 158 °F / 70 °C. The final rinse is 158 °F / 70 °C.

The program meets the requirements of the NSF/ANSI 184 standard.

¹⁾ Program button I (Sanitize NSF) / II (Sani) / III (Sani quick).

To change which pre-selected programs are assigned to the program buttons (I / II / III), select the desired program in the menu and then press and hold the desired program button for five seconds.

 To prevent the risk of burn injuries, the door cannot be opened while the temperature inside the dishwasher exceeds 149 °F / 65 °C.

NOTE!

When the Sanitize NSF program has been run in compliance with the NSF/ANSI 184 standard, "Program done, Dishes Sanitized" is shown on the display.



Crystal

A gentle dishwashing program with a low temperature for washing fragile items made of crystal/glass. Remember to use a small amount of detergent and to place items so that they do not touch each other during the wash. See also *Fragile dishes* in the chapter *Loading the dishwasher*. Porcelain that has just been used without dried leftovers can also be washed using this program.



Intensive

A program with a high temperature for dissolving grease on heavily soiled dishes, such as pans, casserole dishes, and oven dishes. If these dishes do not completely fill the dishwasher, you can add plates and other dishes.



Light

Powerful program for daily use that can remove dried-on food residue, but is not intended for burnt-on food, such as on oven dishes.



Eco

This program is recommended for daily, regular, or typical use to completely wash a full load of normally soiled dishes, such as plates, serving dishes, cups, and glasses.



Self-cleaning

Self-cleaning program for sanitizing the dishwasher tub, spray arms, and spray pipes.

This program should be run (with no dishes in the machine) using dishwasher detergent or citric acid. Special dishwasher cleaners are also available on the market. For the removal of limescale deposits, see *Dishwasher tub* in the chapter *Care and maintenance instructions*.



Rinse and hold

Use to rinse dishes while you wait for the dishwasher to become fully loaded.

▶ □ Start/Stop

Press ▶ □ until the display shows "Program started, Close door within 4 sec". This indicates that the dishwasher is ready to start. Close the door properly within four seconds, otherwise the dishwasher will not start.

If the dishwasher is not started or the door is not closed within 2 minutes of the last time the control panel was pressed, the machine switches off.

To remote start the dishwasher, see the chapter *ASKO Connect Pro & ConnectLife*.

Using the dishwasher

Cancel or changing a program

If you want to change program after starting the dishwasher, open the door then press and hold **▶ □** for three seconds. Add more detergent if the lid of the detergent dispenser has opened (detergent is dispensed automatically if an automatic dosing system is being used). Then select a new program, press **▶ □** and close the door within four seconds.

Time remaining

Once you have chosen a program, the time the program took when last used is displayed.

Once you have started the dishwasher, the display shows the remaining program time. The remaining time is updated during the drying phase.

This may differ somewhat from time to time depending on the temperature of the water supply, the amount of dishes, the ambient temperature, and other factors.

During the first run of each program, the remaining time displayed can be slightly misleading, as the dishwasher is estimating the time. When you run the program a second time, the dishwasher will calculate the remaining time based on the previous duration of the program.

Status light floor projection

The remaining time and temperature of the cleaning cycle and whether the machine is locked are projected onto the floor. The color indicates the current status.

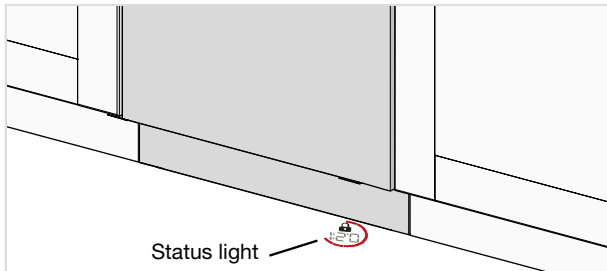

- **Blue** – Load more. The program has started, but you can still load more dishes.
- **Red** – Do not load. You should not load more dishes (risk of poorer dishwashing results).
- **Green** – Unload. The dishwashing program is finished. The status light stays on for 30 minutes.
- **Flashing blue/green** – The status light flashes blue/green to indicate that remote start is activated.
- **Flashing red** – A flashing light indicates that the door has been opened while a program is in progress. If it flashes when the door is closed, an error has occurred. See the complete user manual.

If you want to load more dishes²⁾

Open the door. The dishwasher stops automatically. Add the dishes. Press **▶ □** and close the door within four seconds.

If the dishwashing program was remote started, the interrupted program will continue once the door is closed. You can monitor the dishwasher using the *ConnectLife* app and remote stop the program, although you will not be able to remote start it again.

²⁾ You should not load more dishes if the status light is red.

⚠ WARNING!

If the door is open, "Program paused" is shown on the display. If you want the dishwashing program to continue, press ▶ □ and close the door immediately. If you want to cancel the dishwashing program, press and hold ▶ □ for three seconds.

Power failure

If the dishwasher is turned off due to a power failure when a dishwashing program is running, the program continues when power is restored. If the power is lost during drying, the program is interrupted.

If the dishwashing program was remote started and has not ended, the program will continue once the power is restored. You can monitor the dishwasher using the *ConnectLife* app and remote stop the program, although you will not be able to remote start it again.

If you open the door for more than 2 minutes during drying, the program will be interrupted.

If the dishwasher loses power without Sani lock or Lock activated, the door can be opened manually. Grasp the door high up on both sides and pull straight toward you.

Emergency opener

If the dishwasher loses power when Sani lock or Lock is activated, the door can be opened with the emergency opener.

Push the emergency opener into the bottom edge of the door. Pull the emergency opener until the dishwasher door opens. Then reattach the emergency opener.

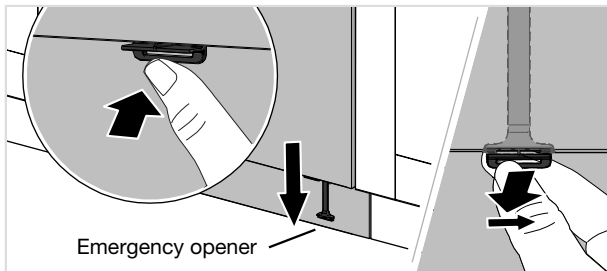

⚠ WARNING!

To prevent the risk of burns, wait until the dishwasher has cooled before opening the door with the emergency opener!

Exercise caution! The edges may be sharp. Wear protective gloves!

Once the program has finished

Once the program has finished, "Program done" appears on the display. The end of the program is also indicated by one short signal sounding and the status light turning green.

The dishwasher automatically enters standby mode after the program has finished.

Using the dishwasher

To minimize the risk of leaks, we recommend that you turn off the water supply valve if away from home for an extended period of time.

The best drying results

- Fully load the dishwasher.
- Angle dishes with hollows, such as cups, so that the rinse water will run off. This is also important for plastic items.
- Fill up the rinse aid compartment or increase the rinse aid dosage setting.
- Activate the Automatic door opening option.
- Activate the Automatic door opening setting.
- Allow the dishes to cool before unloading the dishwasher.

Unloading the dishwasher

Hot porcelain is more fragile. Leave the dishes to cool in the dishwasher before unloading them.

Unload the lower basket first to avoid any water drops from the upper basket falling onto the dishes in the lower basket.

Program	Number of prewashes	Main wash	Number of rinses	Final rinse	Consumption values ¹⁾				
					Cold water ²⁾		Hot water ³⁾		
					Dishwashing time (approx. hrs:min) 15 A / 20 A ⁴⁾	Energy (approx. kWh)	Dishwashing time (approx. hrs:min) 15 A / 20 A ⁴⁾	Energy (approx. kWh)	
Quick, ⁶⁾		≤140 °F / ≤60 °C	2	≤140 °F / ≤60 °C	0.55 / 0.25	0.9	0:17 / 0:17	0.3	3.6
Sani	1	140 °F / 60 °C	2	185 °F / 85 °C	2:00 / 1:10	1.8	1:30 / 1:00	0.9	4.2
Sani quick	1	122 °F / 50 °C	3	185 °F / 85 °C	1:35 / 0:45	1.6	0:55 / 0:29	0.8	5.0
Sanitize NSF	2	158 °F / 70 °C	2	158 °F / 70 °C	3:20 / 2:45	1.9	2:40 / 2:25	1.0	5.4
Crystal, ⁶⁾		113 °F / 45 °C	2	122 °F / 50 °C	1:40 / 1:20	0.8	1:10 / 1:10	0.3	3.3
Intensive, ⁶⁾	2	158 °F / 70 °C	2	158 °F / 70 °C	3:15 / 2:30	1.7	2:45 / 2:20	1.0	5.3
Light, ⁶⁾	1	140 °F / 60 °C	2	149 °F / 65 °C	2:25 / 2:00	1.2	1:55 / 1:50	0.6	4.0
Eco ⁵⁾ , ⁶⁾	1	131 °F / 55 °C	2	140 °F / 60 °C	4:00 / 4:00	1.1	3:30 / 3:30	0.6	3.3
Self-cleaning		158 °F / 70 °C	2	185 °F / 85 °C	1:25 / 1:05	1.4	1:05 / 1:05	1.0	3.2
Rinse and hold			1		0:07 / 0:07	0.01	0:07 / 0:07	0.01	1.2

1) Consumption values vary depending on the temperature of the incoming water, room temperature, load size, selected additional functions, and more.

2) Connection to cold water, approx. 50 °F (10 °C). (A cold water supply is recommended.)

3) Connection to hot water, approx. 120 °F (50 °C).

4) This dishwasher has been designed to be able to be connected to an electrical supply network with fuses for 15 A (120 V) or 20 A (208-240 V). The water in the dishwasher will be heated more quickly, and the dishwashing program will run more quickly, if you select 20 A.

5) The energy guide performance figures are based on this program. Dishwasher connected to cold water, approx. 50 °F (10 °C). This program is recommended for daily, regular or typical use to completely wash a full load of normally soiled dishes, such as plates, serving dishes, cups and glasses.

6) Automatic door opening, default

ASKO Connect Pro & ConnectLife

ASKO Connect Pro

ASKO Connect Pro is a web-based platform that enables you to organize, manage and monitor all your professional ASKO appliances regardless of where they are installed. Once you have connected a professional appliance in the ConnectLife app, a link to ASKO Connect Pro is shown. For more information, please see <https://us.asko.com/professional>.

ConnectLife

ConnectLife is a smart home platform that connects people, devices and services. The ConnectLife app provides advanced digital services and carefree solutions that allow users to monitor and control appliances, receive notifications from a smartphone, and update software (supported features may vary depending on your appliance and the region/country where you are located).

To connect your smart device, you need a home Wi-Fi network (only 2.4 GHz networks are supported) and a smartphone equipped with the ConnectLife app.



To download the ConnectLife app, scan the QR code or search for ConnectLife in your favorite app store.

1. Install the ConnectLife app and create an account.
2. In the ConnectLife app, go to the »Add devices« menu and select the appropriate device type. Then scan the QR code (it can be found on the appliance's serial number plate).
3. The app will then guide you through the entire process of connecting the appliance to your smartphone.
4. Once connected, the appliance can be operated remotely via the mobile app.

Remote control the dishwasher

The dishwasher's network symbol  is shown on the display when the dishwasher is paired with a smartphone/tablet. You can use the *ConnectLife* app to monitor the dishwasher and change settings.

Network symbol on the display

<i>Flashing 0.5 sec on/off</i>	The dishwasher is ready to be connected to your wireless network or paired with your smartphone/tablet.
<i>Flashing 1.0 sec on/off</i>	The dishwasher is connected to your wireless network.
<i>Glow</i>	The dishwasher is connected to your wireless network and the cloud.

Remote start the dishwasher

To remote start the dishwasher, press **•••**. Select Remote start On. Close the door. The status light will flash blue/green to indicate that remote start is activated.

In the *ConnectLife* app, select and start a program.

If the door is not closed within 2 minutes, the machine switches off.

NOTE!

The dishwasher can always be used without the app. When the dishwasher's control panel is pressed, commands from the *ConnectLife* app are blocked for 10 seconds.

If you have any questions, please visit us at www.connectlife.io.

Settings



Open the door and press .

To open the Settings, press .



Select setting

Confirm current setting

Settings	Alternatives	
Lock 	On/Off	<p>To prevent children or persons with reduced mental capabilities from starting the dishwasher, the Lock setting can be activated.</p> <p>To temporarily deactivate the Lock setting, place your foot over the status light floor projection and open the dishwasher door with the Push to open function.</p>
Delayed start	Off/1-24 hours	<p>When you select Delayed start, the dishwasher will start 1-24 hours after you have pressed  and closed the door.</p> <p><i>This Delayed start function is available for some programs.</i></p>
Remote start	On/Off	<p>Activate the setting to be able to remote start the dishwasher. Remote start On is shown on the dishwasher display.</p> <p>Activate the setting each time you want to remote start the dishwasher.</p> <p><i>The setting can be selected with WiFi status Connected.</i></p>
Auto door open 	Quick On/Off Crystal On/Off Intensive On/Off Light On/Off Eco On/Off Rinse and hold On/Off	<p>The dishwasher door opens automatically, which shortens the program time and improves the drying results. Wait until the dishwasher indicates that the program has ended and the dishes have cooled before unloading the dishwasher.</p>

Settings	Alternatives	
Auto dose	Detergent: <i>Off, 3-8 tsp</i>	Activate this setting if you want to connect an automatic dosing system for detergent. This dishwasher is fitted with a water softener, so use detergent and rinse aid doses suitable for soft water. <i>The exact dosage depends on the selected program.</i>
	Rinse aid: <i>Off, 3-8 tsp</i>	Activate this setting if you want to connect an automatic dosing system for rinse aid. <i>The exact dosage depends on the selected program.</i>
Vent the hose	Select Detergent. Press ▶ □ to activate. Close the dishwasher door.	Activate Vent the hose to dispense detergent into the hose. The dishwasher dispenses the detergent for 30 seconds.
	Select Rinse aid. Press ▶ □ to activate. Close the dishwasher door.	Activate Vent the hose to dispense rinse aid into the hose. The dishwasher dispenses the rinse aid for 30 seconds.
TAB (All-in-one detergent)	On/Off	Activate this setting when using an all-in-one detergent that contains rinse aid. <i>This setting reduces the rinse aid dosage and affects how often the dishwasher's built-in softener is regenerated.</i>
Feedback volume	<i>0/1/2/3</i>	A beep confirms that the control panel has been pressed.
Exit	Select <i>Exit</i> and press ●●● to exit the menu for Settings.	

Settings

To open the Advanced settings, press < or > until Advanced settings is shown on the display and confirm your selection with ●●●.

Press: I, II, I, III

Advanced settings	Alternatives	
Language	You can choose the language used for the display.	
WiFi WiFi status	The current WiFi status is shown on the display. Connect the dishwasher to your wireless network to be able to remote control the dishwasher using the <i>ConnectLife</i> app.	
WiFi connection	<i>On/Off</i> After connecting the dishwasher to your local network, you can select <i>WiFi connection Off</i> to deactivate the connection. Select <i>WiFi connection On</i> to reconnect to the same network.	
Connection setup	Connect the dishwasher to your wireless network and pair with your smartphone/tablet. <ul style="list-style-type: none"> In the ConnectLife app, go to the »Add devices« menu and select the appropriate device type. Then scan the QR code (it can be found on the appliance's serial number plate). Select <i>Connection setup</i>. 	
Add device	Pair more devices/users with the dishwasher. <ul style="list-style-type: none"> In the ConnectLife app, go to the »Add devices« menu and select the appropriate device type. Then scan the QR code (it can be found on the appliance's serial number plate). Select <i>Add device</i>. 	
Remove all devices	Select <i>Remove all devices</i> to remove all connected devices/users.	
WiFi factory reset	Select <i>WiFi factory reset</i> to restore the default factory settings.	
Exit	Select <i>Exit</i> and press ●●● to exit the menu for WiFi.	
Select programs	Quick <i>On/Off</i> Sani <i>On/Off</i> Sani quick <i>On/Off</i> Sanitize NSF <i>On/Off</i> Crystal <i>On/Off</i> Intensive <i>On/Off</i> Light <i>On/Off</i> Eco <i>On/Off</i> Self-cleaning <i>On/Off</i> Rinse and hold <i>On/Off</i>	Programs can be shown or hidden in the menu. Choose between On and Off. (Eco cannot be hidden in the menu.) To change which pre-selected programs are assigned to the program buttons (I/II/III), select the desired program in the menu and then press and hold the desired program button for five seconds.
Display Logotype	<i>On/Off</i>	Setting to hide the logo shown on the display.

Advanced settings	Alternatives	
Display Brightness	1/2/3/4	For adjusting the brightness of the display.
Notification volume	0/1/2/3	The buzzer indicates when a dishwashing program has ended. <i>Error messages are always indicated by a loud buzzer.</i>
Rinse aid³⁾	0/1/2/3/4/5	Setting for rinse aid dosage. The rinse aid dispenser can be adjusted between 0 (Off) and 5 (High dosage). Increase the rinse aid dosage: <ul style="list-style-type: none"> • If the dishes have water marks. Reduce the rinse aid dosage: <ul style="list-style-type: none"> • If the dishes have a sticky white/blue film. • If the dishes are streaked. • Heavy foaming. If you have very soft water, the rinse aid can be diluted 50:50 with water.
Water hardness	0/1/2/3/4/5/6/7/8/9 Default: 0	Adjusting the water softener. Select a setting depending on the hardness of the water supply. It is important that this setting is correct. See <i>Water hardness</i> in the chapter <i>Before washing for the first time</i> . For a water supply with a hardness above 5°dH (9°fH / 6°eH / 0.9 mmol/l / 5.9 gr/gal), fill with salt. <i>For a water supply with a hardness below 6°dH (10°fH / 7°eH / 1.0 mmol/l / 6.0 gr/gal), select 0. The water softener is deactivated and no salt needs to be added.</i>

³⁾ The setting will be deactivated following the activation of automatic dosing of the commercial rinse aid. Rinse aid will not then need to be refilled.

Settings

Advanced settings	Alternatives	
Push to open	<i>On/Off</i>	The dishwasher door can be opened without a handle.
Power	15 A/20 A	<p>This dishwasher has been designed to be able to be connected to an electrical supply network with fuses for 15 A (120 V) or 20 A (208-240 V).</p> <p>The water in the dishwasher will be heated more quickly, and the dishwashing program will run more quickly, if you select 20 A. Select 15 A or 20 A according to the electrical supply network in your property.</p>
Interior light at power off	<i>On/Off</i>	<p>Setting to be able to load the dishwasher in accordance with traditional Sabbath rules.</p> <p>Select whether the interior light and ⏻ are to be switched on or remain off when the dishwasher is turned off and the door is opened.</p> <p><i>If ⏻ is turned on, the interior light is always switched on when the door is opened.</i></p>
Single color projection	<i>On/Off</i>	The status light can use 3 colors or white light only.
Failure readout		<p>Any error messages.</p> <p><i>When contacting your Customer Care Center, you may be asked to provide the most recent error messages.</i></p>
Temperature unit	<i>°C/°F</i>	Temperatures can be displayed in °C (Celsius) or °F (Fahrenheit).
Block start when salt chamber is empty	<i>On/Off</i>	<p>Setting to prevent a dishwashing program from starting when the salt compartment is empty.</p> <p><i>This setting is not active if Water hardness is set to 0.</i></p>
Factory reset		<p>Restores all settings to the factory defaults.</p> <p>Select Factory reset and press \blacktriangleright \square.</p>

Advanced settings	Alternatives	
Exit		Select <i>Exit</i> and press ... to exit the menu for Settings.

Care and maintenance instructions

✧ Add rinse aid

When the rinse aid needs topping up, the symbol lights up on the display.

See the chapter *Before washing for the first time*.

⊞ Add salt

When the salt needs topping up, the symbol lights on the display. (You can run 3 programs before the compartment is completely empty.)

See the chapter *Before washing for the first time*.

💧 Add auto dose

When the dishwasher detergent or rinse aid needs topping up, the symbol lights on the display.

See *Automatic dosing* in the chapter *Before washing for the first time*.

Clean the filters

Coarse filter

The coarse filter traps larger food particles, which cannot get past the drain pump. Empty the coarse filter when necessary. It should be cleaned at regular intervals depending on how often the dishwasher is used.

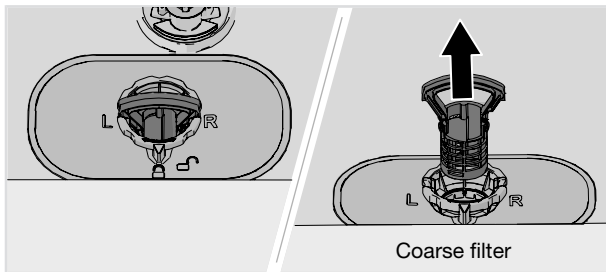

1. Lift the coarse filter by the handle.
2. Empty the coarse filter.
3. Reinstall the coarse filter. Press it down until it clicks into place.

Care and maintenance instructions

Fine filter

Debris that collects on the fine filter is automatically rinsed away during each wash. Clean the fine filter when necessary. It should be cleaned at regular intervals depending on how often the dishwasher is used.

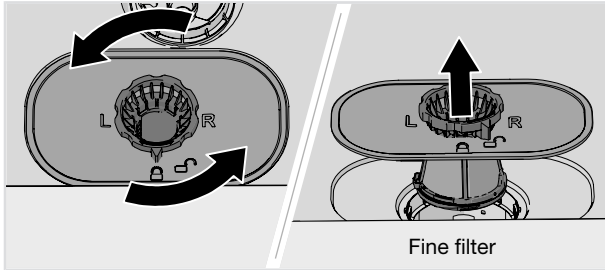

1. Turn the lock ring counterclockwise and lift the fine filter straight up.
2. Clean the fine filter.
3. Refit the fine filter and turn the locking ring clockwise to its stop position. Check that the edges seal properly. Remember to refit the coarse filter as well!

NOTE!

Dishwashing results may be affected if the coarse and fine filters are incorrectly fitted. The dishwasher must not be used without the filters in place!

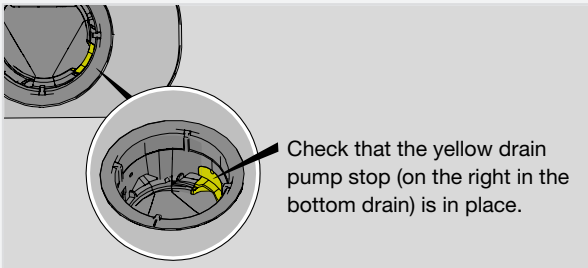

Care and maintenance instructions

Cleaning the spray arms

Holes and bearings can become blocked. Remove debris using a needle or similar item. The spray arms have holes on the bottom.

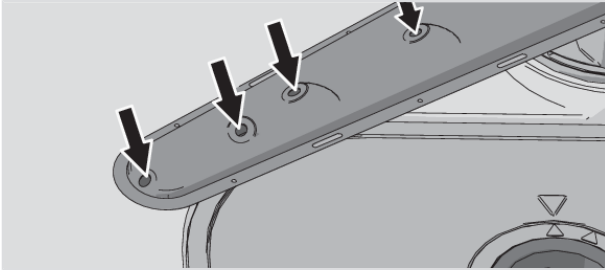

Spray arms can be removed for cleaning. Remember to put them firmly back into place afterward.

Top spray arm

- Push up on the top spray arm while turning it counterclockwise to release it.

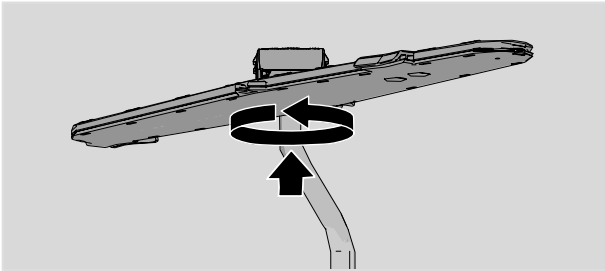

Upper spray arm

- Pull out the upper basket.
- Unscrew the spray arm bearings counterclockwise to remove the spray arm from the upper basket.

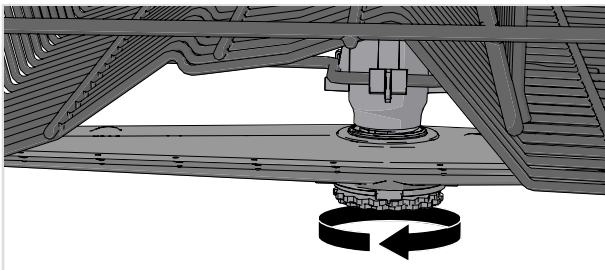

Lower spray arm

- Pull the lower spray arm straight up to release it.

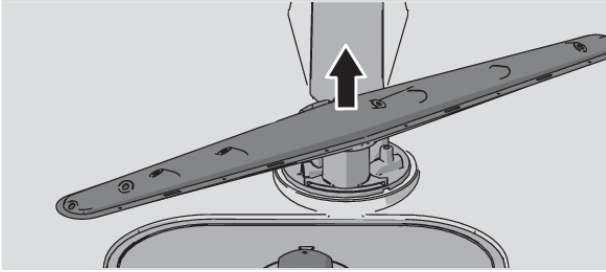

Clean the outside of the dishwasher

Door and door seal

Open the door. Clean the sides of the door and the door seal regularly with a slightly damp cloth. Clean the door seal at the lower front edge of the dishwasher with a cleaning brush.

Control panel

Keep the control panel clean. Use a dry or slightly damp cloth and, if necessary, a little washing up liquid. Avoid strong or abrasive cleaners – they may damage the surface.

⚠ WARNING!

Do not clean the machine using a water jet, pressure washer, or a steam cleaner.

Run Self-cleaning

Dishwasher tub

The dishwasher tub is made of stainless steel and is kept clean through normal use (when used regularly).

If you have hard water, limescale deposits may build up in the dishwasher. If this happens, run the Self-cleaning program with two tablespoons of citric acid in the detergent compartment (with no dishes in the machine). Special dishwasher cleaners are also available in stores.

For the best results when using citric acid, deactivate the automatic dosing of commercial detergent. See the *Settings* chapter.

Never use anti-freeze, Draino®, CLR®, or other chemical cleaners.

Remove blockages

Unblocking the drain pump

If the dishwasher still contains water after the program has finished, something may be blocking the drain pump, which results in the error message Water outlet fault or BLDC drain pump fault.

1. Turn off the machine using ⏻ and remove the plug from the power outlet.
2. Remove the coarse filter and the fine filter.
3. Scoop out the water from the dishwasher tub.
4. In order to inspect the drain pump, remove the yellow drain pump stop on the right in the bottom drain. (Use a pair of pliers if necessary.)

Care and maintenance instructions

5. Turn the pump wheel located behind the drain pump stop by hand. Carefully remove any sharp items, such as glass.
6. Reinstall the drain pump stop along with the fine and coarse filters.
7. Plug the machine in again.

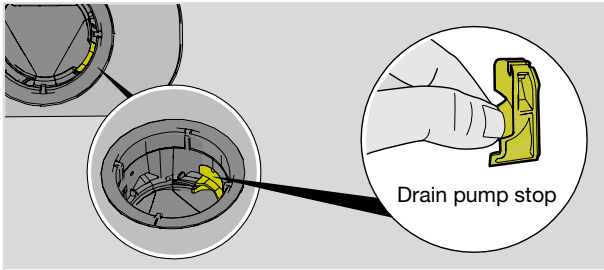

NOTE!

Do not forget to reinstall the drain pump stop.

Error messages		Action
F10	Overfilling water 1	Unblocking the drain pump. See the chapter <i>Care and maintenance instructions</i> . If the problem persists, contact your nearest Customer Care Center.
F11	Water outlet fault	See "Water remains in the dishwasher above the filters" under "Problem" in the table below. If the problem persists, contact your nearest Customer Care Center.
F12	Water inlet fault 1	Check that the water supply valve is on. If the problem persists, contact your nearest Customer Care Center. The water pressure must be between 15 -140 psi (0.1-1.0 MPa).
F40	Inlet valve leakage	Turn off the water supply valve and contact your nearest Customer Care Center.
F41	Heater fault 1	Turn off the water supply valve. Remove the plug from the power outlet and contact your nearest Customer Care Center.
F46	Heater fault 2	Turn off the water supply valve. Remove the plug from the power outlet and contact your nearest Customer Care Center.
F52	Water level fault	Clean the coarse and fine filters. If the problem persists, contact your nearest Customer Care Center.
F54	Overfilling water 2	Turn off the water supply valve and contact your nearest Customer Care Center. To avoid water leakage outside the dishwasher, do not remove the plug from the power outlet until the water supply valve has been turned off!
F56	Circulation pump fault	Run any dishwashing program. If the problem persists, contact your nearest service center.
F67	Water inlet fault 2	Check that the water supply valve is on. If the problem persists, contact your nearest Customer Care Center. The water pressure must be between 15 -140 psi (0.1-1.0 MPa).
F68	BLDC drain pump fault	See "Water remains in the dishwasher above the filters" under "Problem" in the table below. If the problem persists, contact your nearest Customer Care Center.
F70	Lock fault	Close the dishwasher door. If the problem persists, contact your nearest service center.
F76	Sani lock fault	Run any dishwashing program. If the problem persists, contact your nearest service center.

Press any button to clear the error message.

Troubleshooting

General

Problem	Possible causes	Action
The control panel does not react when pressed.	You have pressed the control panel too soon after opening the door.	Wait a moment then try again.
	Lock is activated.	See the chapter <i>Important safety instructions</i> .
	The door is closed.	Open the door. The control panel only reacts to use when the door is open.
	Dirt on the control panel.	Clean with a dry or slightly damp cloth and, if necessary, a little washing up liquid. Avoid strong or abrasive cleaners – they may damage the surface.
	The control panel requires calibration.	Turn off the water supply valve. Remove the plug from the power outlet and wait for 60 seconds. Then plug the appliance back into the power outlet and turn on the water supply valve.
Cannot close door.	The baskets are not correctly positioned.	Check that the baskets are correctly positioned horizontally.
		Check that the dishes are not blocking the baskets from sliding properly into place.
	The door lock does not click into place and lock.	Open the door. Press and hold II and ●●● until "Auto door open recovery" is shown on the display, wait until the message disappears. Close the door, then check that the door lock is working.
The door cannot be opened.	Lock is activated.	See the chapter <i>Important safety instructions</i> .
	To prevent the risk of burn injuries, the door cannot be opened while the temperature inside the dishwasher exceeds 149 °F / 65 °C.	Wait until the dishwasher indicates that the program has ended and the dishes have cooled before unloading the dishwasher.
	The dishwasher is/has been without power while Sani lock or Lock is/has been activated.	See <i>Power failure</i> in the chapter <i>Using the dishwasher</i> or contact your nearest service center.

Problem	Possible causes	Action
The dishwasher does not start.	▷ □ has not been pressed.	Press ▷ □ until the display shows "Program started, Close door within 4 sec".
	The door is not closed properly or was not closed immediately after you pressed ▷ □.	Close the door within four seconds, otherwise the dishwasher will not start.
	Salt compartment empty.	Fill up with salt. See the chapter <i>Care and maintenance instructions</i> .
	The dishwasher door has been opened while a program is in progress.	If you want the dishwashing program to continue, press ▷ □ and close the door within four seconds.
	The door lock has not clicked into place and locked.	Open the door. Press and hold II and ●●● until "Auto door open recovery" is shown on the display, wait until the message disappears. Close the door, then check that the door lock is working.
	The plug is not plugged into the power outlet.	Check.
	A fuse/circuit breaker has been tripped.	Check.

Troubleshooting

Problem	Possible causes	Action
The dishes are not clean.	The spray arms are not rotating freely.	Check that the dishes are not blocking the spray arms.
	Spray arm holes or bearings blocked.	Clean the spray arms. See the chapter <i>Care and maintenance instructions</i> .
	Unsuitable dishwashing program.	Select a program with a high temperature to dissolve grease on heavily soiled dishes, such as Intensive.
	Incorrect detergent dosage.	Dose according to water hardness. Far too much or far too little detergent can result in poor dishwashing results.
	Detergent is too old. Detergent is a perishable product.	Avoid large packages.
	Dishes loaded incorrectly.	Do not cover porcelain with large bowls or the like. Avoid placing very tall glasses in the corners of the baskets. See the chapter <i>Loading the dishwasher</i> .
	Glasses and cups have toppled over during the program.	Load the dishes securely.
	The filters are clogged.	Clean the coarse and fine filters.
	The filters are not fitted correctly.	Check that the filters are fitted correctly. See the chapter <i>Care and maintenance instructions</i> .
	Drain pump stop missing.	Check that the yellow drain pump stop (on the right in the bottom drain) is in place. See the chapter <i>Care and maintenance instructions</i> .
Spots on stainless steel or silver.	Some types of food, such as mustard, mayonnaise, lemon, vinegar, salt, and dressings, can cause spots on stainless steel if left for too long.	Rinse off these types of food if not starting the dishwasher immediately. Use the Rinse and hold program.
	All stainless steel can cause spots on silver if they come into contact during dishwashing. Aluminum can also cause spots on dishes.	In order to avoid marks and tarnishing, separate dishes made from different metals, such as silver, stainless steel, and aluminum.

Problem	Possible causes	Action
Spots or films on the dishes.	Incorrect rinse aid dosage setting.	See the chapter <i>Settings</i> .
	The TAB setting is activated and all-in-one detergent with insufficient drying effect is being used.	Switch all-in-one detergents or deactivate the TAB setting and fill up with salt and separate rinse aid. See Rinse aid in the chapter <i>Settings</i> .
	Incorrect water softener setting.	See Water hardness in the chapter <i>Settings</i> .
	The water softener is leaking salt.	Check that the salt compartment lid is tightened clockwise to its end position. Otherwise contact your nearest service center.
	Too high temperature and/or too much detergent can cause etching on crystal. Unfortunately, this cannot be repaired, only prevented.	Wash crystal at a low temperature using a small amount of detergent. If you have questions about the detergent, contact the detergent manufacturer.
The dishes have a sticky white/blue film.	Rinse aid dosage setting too high.	Reduce the dosage. See the chapter <i>Settings</i> . If you have very soft water, you may want to dilute the rinse aid 50:50 with water.
Spots left after washing.	Lipstick and tea/coffee stains can be difficult to remove.	Use a detergent with a bleaching agent.
Detergent residue in the detergent compartment after dishwashing.	The detergent compartment was damp when adding detergent.	The detergent compartment must be dry when adding detergent.
	The detergent compartment has been blocked.	Check that the dishes are not preventing the detergent compartment from opening.
Rattling sound when dishwashing.	The dishes are not correctly placed or the spray arms are not rotating.	Check that the dishes are placed securely. Spin the spray arms to make sure they can rotate.
"Program paused" is shown on the display.	The dishwasher door has been opened while a program is in progress.	If you want the dishwashing program to continue, press ▶ □ and close the door within four seconds. If you want to cancel the dishwashing program, press and hold ▶ □ for three seconds.

Troubleshooting

Problem	Possible causes	Action
"Block start when salt chamber is empty" is shown on the display.	Salt compartment empty.	Fill up with salt. See the chapter <i>Care and maintenance instructions</i> . (The setting to prevent a dishwashing program from starting when the salt compartment is empty can be deactivated. See the <i>Settings</i> chapter.)
"Sanitation incomplete" is shown on the display.	In order to meet the requirements of the NSF/ANSI 184 standard, the Sanitize NSF program must not be interrupted.	Restart the dishwasher if the program must be run in compliance with the NSF/ANSI 184 standard.
	The Sanitize NSF program has been run but has not reached a sufficiently high temperature to meet the requirements of the NSF/ANSI 184 standard.	Restart the dishwasher if the program must be run in compliance with the NSF/ANSI 184 standard.
Water remains in the dishwasher above the filters.	The filters are clogged.	Clean the coarse and fine filters.
	The filters are not fitted correctly.	Check that the filters are fitted correctly. See the chapter <i>Care and maintenance instructions</i> .
	Debris in the drain pump.	Clean the drain pump. See the chapter <i>Care and maintenance instructions</i> .
	Drain pump stop missing.	Check that the yellow drain pump stop (on the right in the bottom drain) is in place. See the chapter <i>Care and maintenance instructions</i> .
	Kink in drain hose.	Check that the hose is free from kinks and sharp bends.
	Blocked drain hose.	Loosen the drain hose from where it terminates. Check that no debris has clogged the hose. Is the cone-shaped part of the drain boot cut to the maximum size of the fitting where it attaches?

Problem	Possible causes	Action
Bad odor in dishwasher.	Dirt around the seals and in corners.	Clean with dish brush and low foaming cleaner.
	Low temperature programs have been selected for a prolonged period.	Run a program with a high temperature once or twice a month. Or run a self-cleaning program. See Self-cleaning in the chapter <i>Using the dishwasher</i> .
	The dishwasher is connected to a garbage disposer.	Cleaning the garbage disposer connected to the dishwasher can eliminate odors. Follow the disposer manufacturer's cleaning instructions.
Grease deposits in the dishwasher.	Low temperature programs have been selected for a prolonged period.	Select a program with a high temperature to dissolve grease on heavily soiled dishes, such as Intensive. Or run a self-cleaning program once or twice a month. See Self-cleaning in the chapter <i>Using the dishwasher</i> .
The dishes are not dry enough.	The Automatic door opening setting has not been activated.	Activate the Automatic door opening setting.
	The dishwasher is not fully loaded.	Fully load the dishwasher.
	Rinse aid needs filling up or dosage is set too low.	Fill up the rinse aid compartment or increase the rinse aid dosage setting.
	The TAB setting is activated and all-in-one detergent with insufficient drying effect is being used.	Switch all-in-one detergents or deactivate the TAB setting and fill up with salt and separate rinse aid. See Rinse aid in the chapter <i>Settings</i> .

Troubleshooting

WiFi

Problem	Possible causes	Action
The dishwasher's network symbol  does not appear on the display.	The dishwasher is not connected to your wireless network.	Connect the dishwasher to your wireless network. See the chapter <i>ASKO Connect Pro & ConnectLife</i> .
	WiFi connection is deactivated.	Activate WiFi connection. See WiFi connection <i>On/Off</i> in the chapter <i>Settings</i> .
Connection setup failed	The dishwasher cannot access your wireless network. Or the router is not connected to the internet.	Check that the router is connected to the internet.
		Make sure your wireless network is using 2.4 GHz and is visible. Try moving the router closer to the dishwasher if the signal is too weak.
		See also troubleshooting at www.connectlife.io . If the problem persists, contact your nearest Customer Care Center.
Add device failed	Your smartphone/tablet is not connected to your wireless network. Or the router is not connected to the internet.	Check that the router is connected to the internet.
		Check that your smartphone/tablet is connected to your wireless network.
		See also troubleshooting at www.connectlife.io . If the problem persists, contact your nearest Customer Care Center.
The dishwasher is shown as disconnected in the <i>ConnectLife</i> app.	WiFi connection is deactivated.	Activate WiFi connection. See WiFi connection <i>On/Off</i> in the chapter <i>Settings</i> .
		See also troubleshooting at www.connectlife.io . If the problem persists, contact your nearest Customer Care Center.

Problem	Possible causes	Action
Software update failed.	The network connection was lost or the dishwasher lost power due to a power failure.	Make sure that the power supply is not interrupted and that the network connection is stable before trying again. If the problem persists, contact your nearest Customer Care Center.

Installation instructions

It is important that you read through and follow the instructions and directions below. Other directions for installation and connection can be found in the separate installation instructions.

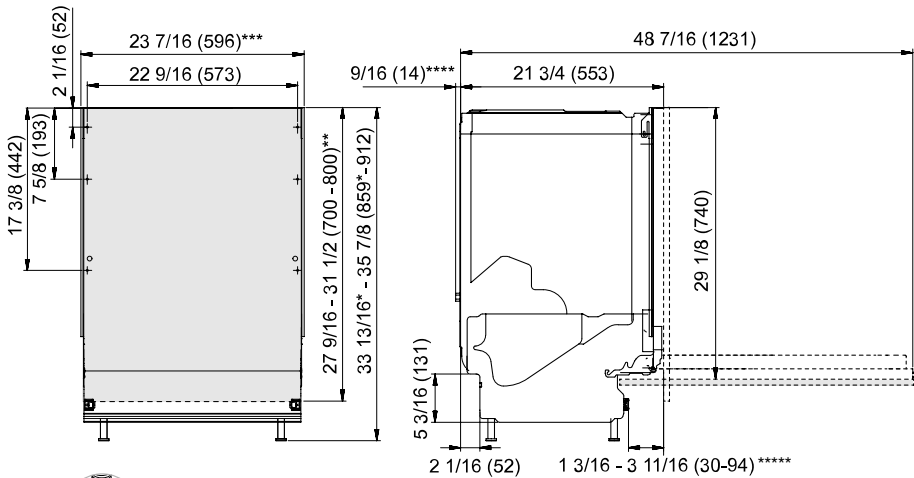

*Remove lock nuts for an installed height of 33 3/4 - 33 13/16" (857-859 mm)

** Integrated door panel length.

*** Install the trim kit if the widths of 24" (609 mm) is required.



**** Connection to an automatic dosing system

***** Status light, min. 2" (50 mm).

Inches (mm)

Nominal dimensions. Actual measurements may vary.

Important safety instructions

- Connections to electricity, water, and drain must be performed by a qualified professional.
- Always follow applicable regulations for water, drainage, and electricity.
- Take care during installation! Wear protective gloves! There must always be two people!
- Place a drip tray on the floor beneath the dishwasher to prevent damage from any water leaks.
- Before fastening the dishwasher, test the dishwasher by running the Rinse and hold program. Check that the dishwasher fills with water and drains. Check also that none of the connections leak.

⚠ WARNING!

The ventilation opening in the lower part of the door must not be blocked by a rug, carpet, or similar furnishing.

⚠ WARNING!

Turn off the water supply when installing the dishwasher!

During installation and the performance of any maintenance work, the plug must be removed from the power outlet, or the power outlet's supply must be disconnected!

Setup

- The recess and connection dimensions are included in the separate installation instructions. Check that all dimensions are correct before starting the installation. Note that the height of the integrated door panel can be adjusted to match other fittings.

The electrical and water supplies should enter through the area indicated by the shading on the illustration.

* 24" (609 mm) with the trim kit.

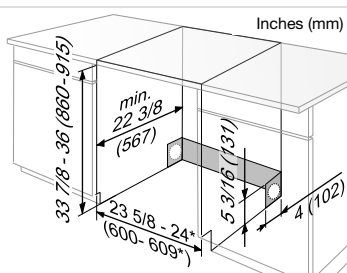

- Handle the front corners of the dishwasher with care so that they do not get bent, which can affect door opening.
- Make sure the area on which the dishwasher is to be installed is firm. Adjust the adjustable feet so that the dishwasher is level. Tighten the lock nuts.
- If the dishwasher is built-in, the surrounding furnishings must be resistant to any condensation from the dishwasher.
- Mount the protective film beneath the countertop and up around the edge. The function of the protective film is to protect the countertop from moisture. (The protective film is in the enclosed plastic bag.)
- Check that the machine is installed such that the door opens freely, otherwise door lock functionality may be disrupted.
- Note that the door springs may need adjusting after a cover door has been fitted. Adjust the left and right door springs equally until the door is evenly balanced.

Installation instructions

NOTE!

Framed cabinets require additional finished filler material behind the face frame for a proper installation. A minimum 3 1/2" (89 mm) finished return is required on all sides of the opening. (The dishwasher packaging includes wooden strips that can be repurposed as filler material.)

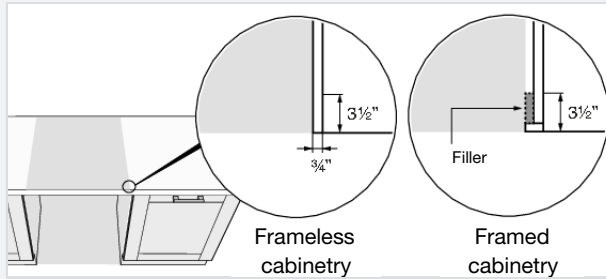

Connection to an automatic dosing system

The dishwasher can be connected to one or more systems for the automatic dosing of commercial detergent and rinse aid, which simplifies everyday operation and reduces the risk of overdosing.

Connection to a system for automated dosage must be performed by the supplier of the system or by somebody with an equivalent professional qualification.

⚠ WARNING!

Danger of contact with high voltage! Remove the plug from the power outlet.

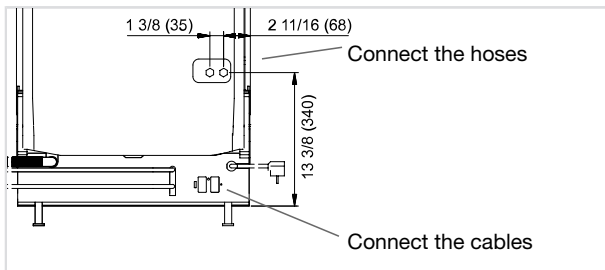

Connect the cables

Connect the external cables for automatic dosing to the back of the dishwasher.

The length of the external cables must not exceed 118" (3.0 m).

1. Loosen the screw to remove the protective cover.

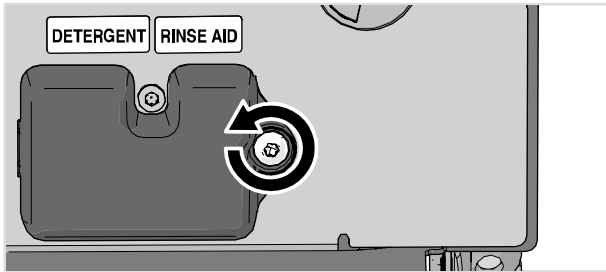

2. Connect the external cables for detergent to the auto dose connector.

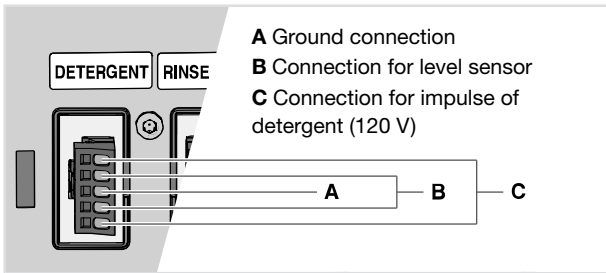

3. Connect the external cables for rinse aid to the auto dose connector.

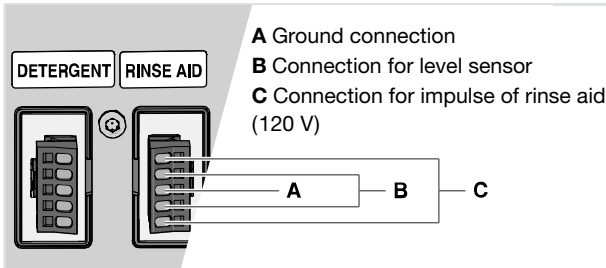

Accessory

Buy an accessory kit, including nipples and hoses, for connection to an automatic dosing system. Accessories can be purchased where you bought the dishwasher.

Connect the hoses

Connect the hoses for automated dosage at the back of the dishwasher.

1. Remove plugs.

Installation instructions

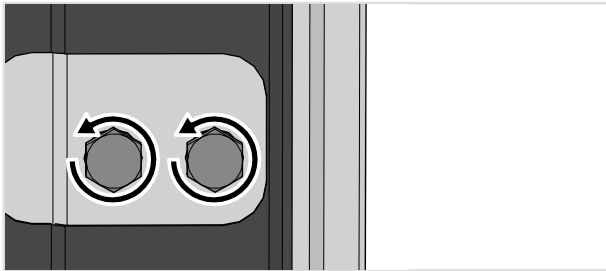

2. Attach the nipple and connect the hose for detergent.

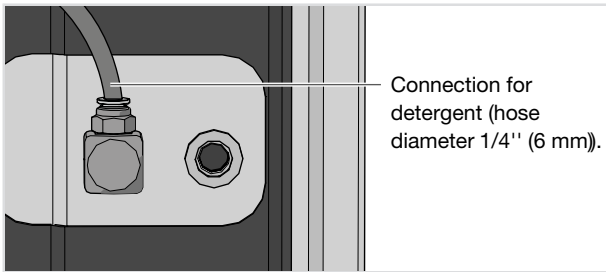

3. Attach the nipple and connect the hose for rinse aid.

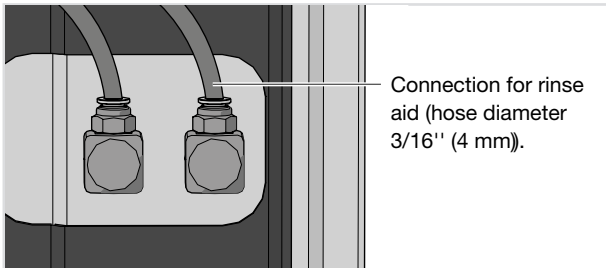

- Activate Auto dose. See the chapter *Settings*.
- Use the Vent the hose function to vent the system.

WARNING!

Note that there are risks involved in handling commercial detergent and rinse aid. Protective gloves and goggles must be used when handling these products.

Follow the supplier's safety regulations concerning the handling and storage of detergent and rinse aid.

WARNING!

Always install protective caps and plugs when disconnecting a system for automatic dosing.

Drain connection

This dishwasher is suitable for installing in a raised recess (to obtain an ergonomic working height). This means that the dishwasher can be placed so that the drain hose runs to a lower level than the bottom of the dishwasher, such as by routing it directly to a floor drain.

The drain hose can also be connected to a cone-shaped connection pipe on the sink unit's water trap. The connection pipe must have an internal diameter of at least 9/16" (14 mm).

The drain hose may be extended by a maximum of 87" (2.2 m) (the total length of the drain hose must not exceed 177" (4.5 m)). Any joints and connecting pipes must have an internal diameter of at least 9/16" (14 mm).

No part of the drain hose may be more than 37 3/8" (950 mm) above the bottom of the dishwasher.

Cut the end of the drainage hose that can be shortened. Use the largest possible diameter to ensure the best possible drainage capacity.

Attach the drain hose with a hose clamp. Ensure that the drain hose has no kinks.

No external air gap is necessary (unless specified by building codes in your area), as the dishwasher is already equipped with an internal air gap and high loop drain line.

Connection to water supply

The dishwasher can be connected to hot (max. 160 °F (70 °C)) and/or cold water. The dishwasher adjusts automatically to the connected water in order to achieve the best dishwashing result. To achieve optimal short dishwashing time, the dishwasher should be connected to hot water.

The dishwasher comes with an extra inlet hose (packed inside dishwasher) to connect hot and cold water. Use only the fitted inlet hose and the enclosed inlet hose. Do not reuse old or other hoses.

The supply pipe must be fitted with a water supply valve. The water supply valve must be easily accessible, so that the water can be shut off if the dishwasher has to be moved.

The water pressure must be between 15 -140 psi (0.1-1.0 MPa). To achieve optimal short dishwashing time, the water pressure must be at least 30 psi (0.2 MPa).

Once the installation is complete, turn on the water supply valve and allow the pressure to settle for a while. Check that all connections are watertight.

Connect an extra inlet hose

1. Loosen the screws to remove the protective cover.
2. Remove the plug.

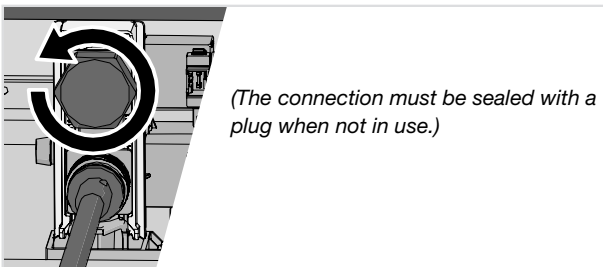

3. Fit the enclosed inlet hose.

Installation instructions

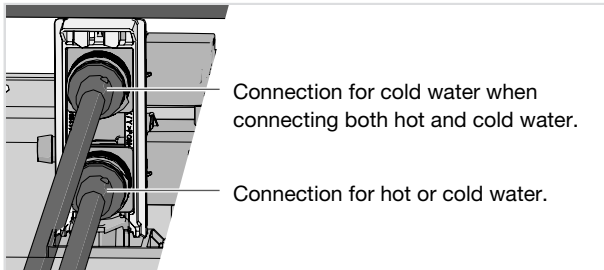

4. Reattach the protective cover.

Water supply

The machine can be connected to either a cold or a hot (max. 140 °F (60 °C)) water supply. The water pressure should be 15 -140 psi (0.1-1.0 MPa).

Electrical connection

Information about the electrical connection can be found on the serial number plate. This specification must match the electricity supply.

The power outlet for the appliance shall be installed in a cabinet or on a wall adjacent to the undercounter space in which the appliance is to be installed. Do not use an extension cord for this appliance.

The access hole for the electrical supply must be round and smooth and no bigger than 2 3/4" (70 mm) in diameter. If the partition is metal, it needs to be covered with an edge protector.

Use caution when the appliance is installed or removed to reduce the likelihood of damage to the power cord.

Grounding instructions

This appliance must be grounded. In the event of a malfunction or breakdown, grounding will reduce the risk of electric shock by providing a path of least resistance for electric current. This appliance is equipped with a power cord fitted with an equipment grounding conductor and a grounding plug. The plug must be plugged into an appropriate power outlet that is installed and grounded in accordance with all local codes and ordinances.

⚠ WARNING!

Improper connection of the equipment grounding conductor can result in a risk of electric shock. Check with a qualified electrician or service representative if you are in doubt as to whether the appliance is properly grounded. Do not modify the plug provided with the appliance. If it does not fit the power outlet, have an appropriate power outlet installed by a qualified electrician.

Hardwire your dishwasher

If you choose to hardwire your dishwasher instead of using the factory-supplied power cord, it is acceptable to cut the cord for direct connection, provided that the installation follows all applicable national and local electrical codes. Hardwiring must be performed by a qualified electrician to ensure safety and compliance with these codes.

When hardwiring the dishwasher, make sure to use appropriate wire sizes, connectors, and circuit protection as required by your local code. Always turn off the power at the breaker panel before

beginning any electrical work. Refer to the dishwasher's wiring diagram and your local building codes to ensure proper installation.

Failure to adhere to these standards may result in electrical hazards, appliance damage, or voiding of the manufacturer's warranty. Additionally, in the event of a failure, the manufacturer may request photo documentation of the hardwired connection to verify that the installation was performed correctly.

For your safety, if you are unsure or unfamiliar with the electrical requirements, it is recommended to hire a licensed professional to complete the installation.

Replacing the power cord

All work on the electrical connection must be performed by a qualified service technician. If replacing the power cord, use only original ASKO replacement parts. For technical data, see the wiring and conversion diagram supplied with the machine.

Push to open

The dishwasher door can be opened without a handle.

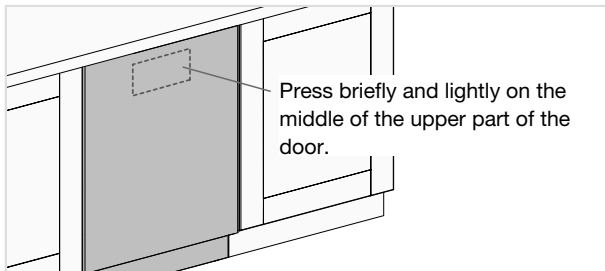

NOTE!

The door can be opened manually if the dishwasher is not connected to the electrical supply. Grasp the top of the door on both sides and pull straight out.

Service and warranty

Limited Warranty – Residential and Professional Appliances

This Limited Warranty covers parts and labor, except as set forth in this Limited Warranty. Service must be provided by an authorized ASKO service company. YOUR SOLE AND EXCLUSIVE REMEDY UNDER THIS LIMITED WARRANTY SHALL BE PRODUCT REPAIR AS PROVIDED HEREIN. This Limited Warranty is valid only when the ASKO Product is used in the country in which it was purchased. Proof of original purchase date is required to obtain service under this Limited Warranty. This warranty only applies to the original purchaser and is non-transferable.

Residential ASKO Products Used Exclusively for Household/Personal Purposes:

Two (2) Years limited Warranty – Any warranty service claims for residential ASKO Products must be filed with ASKO within two (2) years from date of purchase. Service will be provided during normal business hours. ASKO Dishwashers eligible under 2024-2025 5-Year Warranty Promotion must be registered via us.asko.com website.

Residential ASKO Products Not Used Exclusively for Household/Personal Purposes or used Commercially or used in Marine, Mobile or Aeronautical Applications:

One (1) Year limited Warranty – Any warranty service claims for ASKO Products not used exclusively for household and personal use, or used commercially or used in marine, mobile, or aeronautical applications must be filed with ASKO within one (1) year from date of purchase. Service will be provided during normal business hours.

Professional ASKO Products Used In Residential or Commercial Applications:

Two (2) Years limited Warranty – Any warranty service claims for residential ASKO Products must be filed with ASKO within two (2) years from date of purchase. Service will be provided during normal business hours.

Items excluded from warranty

This limited warranty does not cover:

1. Replacement parts or repair labor if the ASKO Product is used in a manner that is inconsistent with published user or operator instructions and/or installation instructions.
2. Service calls to correct the installation of the ASKO Product, to instruct you on how to use the ASKO Product, to replace or repair house fuses, or to correct house wiring or plumbing.
3. Consumable items and parts, such as filters.
4. Damage resulting from accident, alteration, misuse, abuse, negligence, fire, flood, natural disasters, improper use, improper installation, installation not in accordance with electrical or plumbing codes, or use of products not approved by ASKO, as well as any attempted repair by other than authorized ASKO service companies.
5. Cosmetic damage, including scratches, dents, chips or other damage to the finish of the ASKO Product, unless such damage results from defects in materials or workmanship and is reported to ASKO within 5 days from date of purchase.
6. Pickup and delivery. The ASKO Product is intended to be repaired in your home.
7. Repairs to parts or systems resulting from unauthorized modifications made to the ASKO Product.
8. Expenses for travel and transportation for product service if the ASKO Product is located in a remote area where service by an authorized ASKO service company is not available.
9. The removal and reinstallation of the ASKO Product if it is installed in an inaccessible location or is not installed in accordance with ASKO's published installation instructions.
10. Replacement parts or repair labor on ASKO Products with original model/serial numbers that have been removed, altered or cannot be easily determined.

Disclaimer

YOUR SOLE AND EXCLUSIVE REMEDY UNDER THIS LIMITED WARRANTY SHALL BE PRODUCT REPAIR AS PROVIDED HEREIN. EXPRESSLY DISCLAIMED ARE ALL OTHER EXPRESS AND IMPLIED WARRANTIES, INCLUDING ANY IMPLIED WARRANTIES OF MERCHANTABILITY AND FITNESS FOR A PARTICULAR PURPOSE. Some jurisdictions do not allow exclusion or limitations regarding warranty rights. This Limited Warranty gives you specific legal rights and you may have other rights that vary from jurisdiction to jurisdiction. Attempted repair by any person other than an authorized ASKO service company will void this Limited Warranty.

Limitation of liability

IN NO EVENT SHALL ASKO OR THE MANUFACTURER AND THEIR RESPECTIVE PARENTS, SUBSIDIARIES AND AFFILIATES BE LIABLE FOR CONSEQUENTIAL, INCIDENTAL, EXEMPLARY, PUNITIVE OR SPECIAL DAMAGES. IN NO EVENT SHALL ASKO OR THE MANUFACTURER AND THEIR RESPECTIVE PARENTS, SUBSIDIARIES AND AFFILIATES BE LIABLE FOR DAMAGES OTHER THAN ACTUAL DAMAGES AND IN NO EVENT FOR DAMAGES IN EXCESS OF THE PRICE PAID FOR THE ASKO PRODUCT AS TO WHICH A CLAIM IS MADE. Some jurisdictions do not allow the exclusion or limitation of incidental, consequential or other damages, so these limitations and exclusions may not apply to you. This Limited Warranty gives you specific legal rights. You also may have other rights that vary from jurisdiction to jurisdiction.

ASKO Customer Care

Read the chapter *Troubleshooting* before contacting the Customer Care Center. If you have encountered a problem that you cannot resolve, please contact your nearest dealer.

USA	us.asko.com, +1-800-898-1879
CANADA	ca.asko.com, +1-800-561-7265, service@distinctive-online.com
MEXICO	asko.com/mx, +52-800-400-4372, atencionalcliente@sub-zeromx.com

When making contact, provide the details on the serial number plate. Include the model name (1), the article number (2), and the serial number (3).

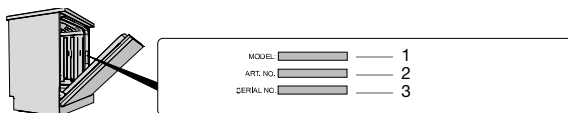

Service after expiration of limited warranty

For information about obtaining parts and labor after expiration of this Limited Warranty or arising outside the scope of this Limited Warranty, please contact ASKO Customer Care.

Number of cycles

Press and hold > and ●●● for 3 seconds to show Number of cycles that have been run on the display.

Technical information

Technical data

Height:	33 13/16 - 35 7/8" (859-912 mm)
Width:	23 7/16" (596 mm) ¹⁾
Depth:	21 3/4" (567 mm) ²⁾
Weight:	120 lb (55 kg) ³⁾
Water pressure:	15 -140 psi (0.1-1.0 MPa)

¹⁾ 24" (609 mm) with the trim kit.

²⁾ Including nipples for connection to an automatic dosing system.

³⁾ Weight can vary due to different specifications.

Electrical connection

	Supplied power cord	Possible rewiring¹⁾
Voltage:	2 N AC 120 / 208-240 V	AC 120 V
Frequency:	60 Hz	60 Hz
Fuse rating:	2 x 30 A	15 A
Plug:	14-30P NEMA	5-15P NEMA
Power cord cross-section:	4 x AWG10	3 x AWG14
Heat output:	2,55 kW - 2,95 kW	1,4 kW
Rated power:	2,65 kW - 3,05 kW	1.5 kW

¹⁾ All work on the electrical connection must be performed by a qualified service technician. If replacing the power cord, use only original ASKO replacement parts. For technical data, see the wiring and conversion diagram supplied with the machine.

 **ASKO**
PROFESSIONAL

US.ASKO.COM • CA.ASKO.COM • ASKO.COM/MX



940994-a4

*Translation of the original instructions.
We reserve the right to make changes.*