

Revery R8 **SB-100**

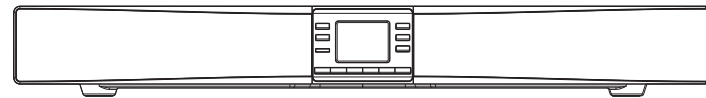

GB

Version 1



The UNDOK App enables remote control of the Revery R8 (SB-100) running on your iPhone, iPod touch, iPad or Android smartphone. The UNDOK™ App is available for Android and iOS. You can easily control every SmartLink device from your Smartphone or tablet with our full function UNDOK™ App to stream your favorite music or station. Download and install free UNDOK™ App simply from the Apple iTunes App store or Android Google Play store to control your music now.



The Bluetooth® word mark and logos are registered trademarks owned by Bluetooth SIG, Inc. and any use of such marks by SANGAN ELECTRONICS INC. is under license.



Sagean Revery R8 (SB-100) powered by Qualcomm® aptX™ audio.

Qualcomm is a trademark of Qualcomm Incorporated, registered in the United States and other countries, used with permission. aptX is a trademark of Qualcomm Technologies International, Ltd., registered in the United States and other countries, used with permission.

Contents

| | | | |
|--|--------------|--|--------------|
| Introduction | 1-10 | DAB mode | 45-52 |
| <i>Important safety instructions</i> | 4 | <i>Selecting a DAB radio station</i> | 46 |
| <i>Before you can use this product</i> | 5 | <i>Display modes</i> | 47 |
| <i>Controls and connections</i> | 6-7 | <i>Finding new DAB radio stations</i> | 48 |
| <i>Remote control operation</i> | 8-9 | <i>Manual Tuning</i> | 49 |
| <i>Navigation controls</i> | 10 | <i>Dynamic Range Control settings</i> | 50 |
| Installation | 11-20 | <i>Station order setup</i> | 51 |
| <i>Installing the soundbar</i> | 11-13 | <i>Prune stations</i> | 52 |
| <i>Connecting the soundbar</i> | 14-19 | FM mode | 53-59 |
| <i>Infra-red repeater function</i> | 20 | <i>Operating your radio in FM mode</i> | 53 |
| <i>Antenna switch</i> | 20 | <i>Manual tuning</i> | 54 |
| Network configuration | 21-30 | <i>Display modes</i> | 55 |
| <i>Connecting your soundbar to your computer network</i> | 21-27 | <i>Scan setting</i> | 56 |
| <i>Using the UNDOK app</i> | 28-29 | <i>Stereo / Mono switching</i> | 57 |
| <i>Network remote control options</i> | 30 | <i>Presetting stations in DAB and FM modes</i> | 58-59 |
| <i>Using an ethernet connection</i> | 30 | Music Player mode | 60-72 |
| Internet Radio mode | 31-44 | <i>Use with Windows, Apple Mac, Linux</i> | 60 |
| <i>Internet Radio - the basics</i> | 31 | <i>Accessing your audio files via a UPnP server</i> | 61-62 |
| <i>Selecting a radio station by location and genre</i> | 32-34 | <i>Locating and playing media files using UPnP</i> | 63-66 |
| <i>Searching for a radio station by name</i> | 35 | <i>Display modes</i> | 67 |
| <i>Selecting a new or popular station</i> | 36 | <i>Playlists</i> | 68-70 |
| <i>Selecting a podcast</i> | 37 | <i>Prune servers</i> | 71 |
| <i>Presetting stations</i> | 38-39 | <i>Windows 'Play To' / 'Cast to Device' function</i> | 72 |
| <i>Display modes</i> | 40 | Listening to Spotify | 73-75 |
| <i>Customising your soundbar</i> | 41-44 | | |

Contents

| | | | |
|---|----------------|---|-----|
| Listening to music via Bluetooth streaming | 76-79 | <i>Software version display and Audio FAQ</i> | 106 |
| Clock and Alarms | 80-89 | <i>Audio codecs</i> | 107 |
| <i>Automatically updating the clock</i> | 80 | <i>Specifications</i> | 108 |
| <i>Setting the clock format</i> | 81 | | |
| <i>Manually setting the clock</i> | 82-83 | | |
| <i>Setting the alarm clock</i> | 84-86 | | |
| <i>Snooze timer</i> | 87 | | |
| <i>Disabling alarms</i> | 88 | | |
| <i>Sleep timer</i> | 89 | | |
| Multi-room and UNDOK | 90-93 | | |
| Display and Audio | 94-100 | | |
| <i>TV audio options</i> | 94-95 | | |
| <i>Equaliser function</i> | 96-97 | | |
| <i>Subwoofer control</i> | 98 | | |
| <i>Mute function</i> | 98 | | |
| <i>Brightness control</i> | 99 | | |
| <i>Inactive Standby timer</i> | 100 | | |
| <i>Language selection</i> | 100 | | |
| Information | 101-108 | | |
| <i>Factory reset</i> | 101 | | |
| <i>Software update</i> | 102 | | |
| <i>Network profiles</i> | 103 | | |
| <i>Clear network settings</i> | 104 | | |
| <i>Manual network configuration</i> | 105 | | |



Important safety instructions

1. Read these instructions.
2. Keep these instructions.
3. Heed all warnings.
4. Follow all instructions.
5. Do not use this apparatus near water.
6. Clean only with dry cloth.
7. Do not block any ventilation openings. Install in accordance with the manufacturer's instructions.
8. Do not install near any heat sources such as radiators, heat registers, stoves, or other apparatus (including amplifiers) that produce heat.
9. Do not defeat the safety purpose of the polarized or grounding-type plug. A polarized plug has two blades with one wider than the other. A grounding type plug has two blades and a third grounding prong. The wide blade or the third prong are provided for your safety. If the provided plug does not fit into your outlet. Consult an electrician for replacement of the obsolete outlet.
10. Protect the power cord from being walked on or pinched particularly at plugs, convenience receptacles, and the point where they exit from the apparatus.
11. Only use attachments/accessories specified by the manufacturer.
12. Use only with the cart, stand, tripod, bracket, or table specified by the manufacturer, or sold with the apparatus. When a cart is used, use caution when moving the cart/ apparatus combination to avoid injury from tip-over. 
13. Unplug this apparatus during lightning storms or when unused for long periods of time.
14. Refer all servicing to qualified service personnel. Servicing is required when the apparatus has been damaged in any way, such as power-supply cord or plug is damaged, liquid has been spilled or objects have fallen into the apparatus, the apparatus has been exposed to rain or moisture, does not operate normally, or has been dropped.
15. To Reduce the Risk of Fire or Electric Shock, Do not Expose This Appliance To Rain or Moisture.
16. The Shock Hazard Marking and Associated Graphical Symbol is provided on the rear of unit.
17. Apparatus shall not be exposed to dripping or splashing and no objects filled with liquids, shall be placed on the apparatus.
18. The power plug should be close to the soundbar, and easy to be approached that during the emergency, to disconnect the power from the soundbar, just unplug the power plug from the AC power slot.
19. Where the MAINS plug or an appliance coupler is used as the disconnect device, the disconnected device shall remain readily operable.

CAUTION:

These servicing instructions are for use by qualified service personnel only. To reduce the risk of the electric shock, do not perform any servicing other than that contained in the operating instructions unless you are qualified to so.

Before you can use this product

Before you can use your soundbar, you must have the following:

- A broadband Internet connection.
- A router (or equivalent wireless access point) providing a WiFi signal or Ethernet connection, connected to your broadband Internet Service Provider. The broadband modem, router and wireless access point will often be a single combined unit supplied by your Internet Service Provider or bought from a computer store.
- A smartphone or tablet which uses either the Android operating system (version 4.0.3 or later) or Apple iOS (version 8 or later).
- If your wireless network requires a security password to allow connection, then you either need to know the WEP, WPA or WPA2 key used for encryption so that you can get the soundbar to communicate with the network, or your router needs to offer WiFi Protected Setup (WPS).
- If you choose to connect the soundbar to your network using a wired Ethernet connection, then an Ethernet cable of appropriate length will be needed. If it is intended to listen to FM radio extensively, then there may be benefit in using a shielded Ethernet cable since this may reduce possible interference to the radio.

The soundbar is compatible with 802.11b, g, n or a networks and can use 2.4 GHz or 5 GHz WiFi frequency bands.

If connecting using WiFi, the soundbar will typically work within a 10-20 metre radius from your wireless router or access point. The actual range achieved will depend upon the building type, other nearby wireless networks, and possible interference sources. DAB and FM radio functions can operate wherever the soundbar is able to receive a suitable broadcast signal.

IMPORTANT: Before you continue, make sure that your router (or access point) is powered up and working with your broadband Internet service (use your computer, smart-phone or tablet to verify this). To get this part of the system working you must refer to the instructions supplied with those items.

Controls and connections

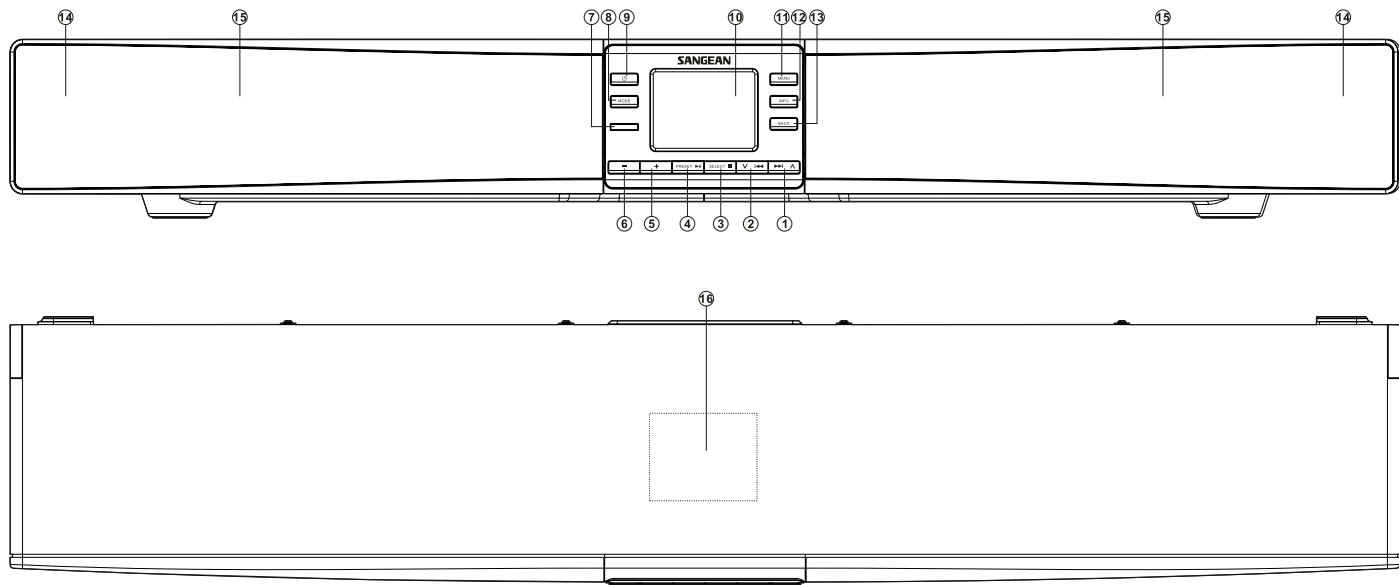

1. Menu Up / Right / Next button
2. Menu Down / Left / Previous button
3. Select / Stop button
4. Preset / Play / Pause button
5. Volume Up button
6. Volume Down button

7. Remote control sensor
8. Mode button
9. On / Standby button
10. LCD display
11. Menu button
12. Info button

13. Back button
14. Tweeter / Mid-range speaker x 2
15. Bass / subwoofer speaker x 2
16. NFC detection area

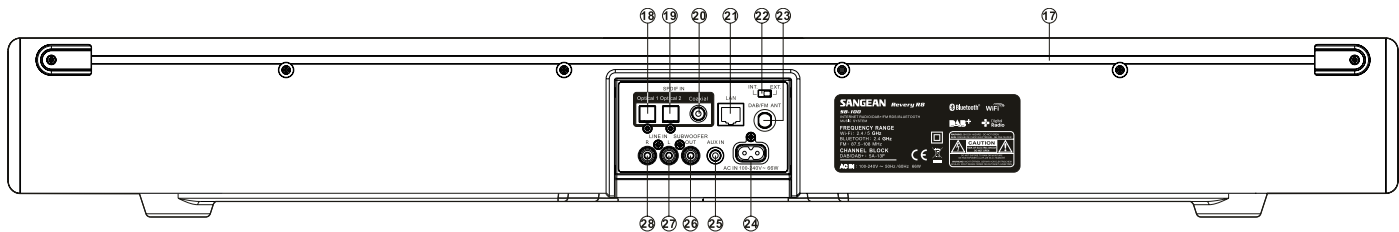

17. Infra-red repeater /

Internal DAB / FM antenna

18. Optical 1 digital input socket

19. Optical 2 digital input socket

20. Coaxial digital input socket

21. Ethernet socket (RJ45)

22. Internal / External antenna switch

23. External DAB / FM antenna socket

24. Mains input socket

25. Auxiliary input socket

26. External subwoofer output socket

27. Line input socket (left)

28. Line input socket (right)

Remote control handset

- A. On / Standby button
- B. Alarm button
- C. Infra-red LED
- D. Sleep / Clock Set button
- E. CD Eject button (not available in this model)
- F. Record button (not available in this model)
- G. EQ button
- H. Info / Menu button
- I. Select / Stop button
- J. Menu Right / Next button
- K. Play / Pause button
- L. Volume Up / Down button
- M. Mute button
- N. Random button
- O. Repeat button
- P. Key pad buttons 1-10/0
- Q. Subwoofer Up / Down button
- R. Menu Down / Folder Down button
- S. Back button
- T. Menu Left / Previous button
- U. Menu Up / Folder Up button
- V. Auto Tune button
- W. Media button
- X. Radio button
- Y. Dimmer button

Remote control functions

Most of the functions of the SB-100 soundbar can be controlled using either the product or the remote control. For the majority of this manual we will describe operation using the remote control.

There are a few functions which are more easily accessed using the remote control. These are:

- | | |
|-----------------------|--------------------|
| Radio station presets | DAB / FM auto-tune |
| Random function | Audio mute |
| Repeat function | |

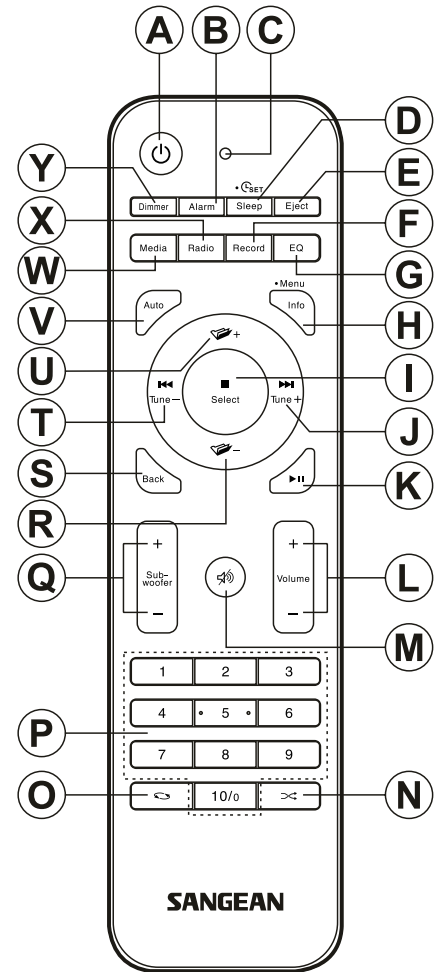

Remote control battery replacement

1. Slide out the battery holder as shown.
2. Gently remove the batteries from the holder.
3. Insert 2 x CR2032 size batteries into the compartment with the positive side of the batteries (marked +) facing upwards with the holder positioned as shown.

Note: The remote control uses CR2032 batteries. For optimum battery life, fit batteries in locations A and B. The control can also be used with a single battery installed in location A but the battery life will be reduced. The control will not work if there is only a single battery installed in location B.

4. Replace the battery holder as shown and ensure that the battery holder clicks into place.
5. If the remote is not to be used for an extended period of time it is recommended that the batteries are removed.

IMPORTANT: The batteries should not be exposed to excessive heat such as sunshine, fire or the like. After use, disposable batteries should if possible be taken to a suitable recycling centre. On no account should batteries be disposed of by incineration.

WARNING:

- Do not ingest the battery. Chemical Burn hazard.
- The remote control supplied with this product contains a coin/button cell battery. If the coin/button cell battery is swallowed it can cause severe internal burns in just 2 hours and can be fatal.
- Keep new and used batteries away from children. They can be a choking hazard.
- If the battery compartment does not close securely, stop using the product and keep it away from children.
- If you think batteries might have been swallowed or placed inside any part of the body, seek immediate medical attention.

CAUTION:

Danger of explosion if the battery is incorrectly replaced. Replace only with the same or equivalent type.

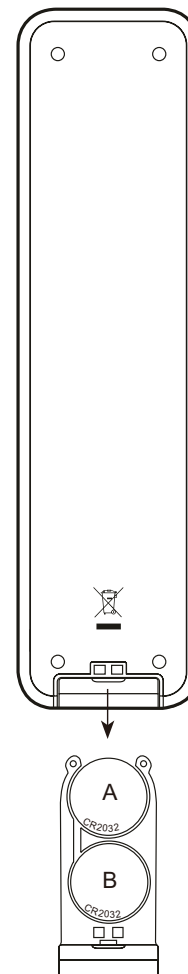

Navigation controls

This page describes the basic means of controlling your SB-100 Soundbar. Instructions for each operating mode are given in the later sections of this book.

1. Pressing the **On/Standby** button brings your soundbar out of Standby mode. Pressing **On/Standby** while the soundbar is in use will cause it to return to the Standby mode with the clock display.
2. Pressing the **Radio** button (on the remote control) gives you access to each of the operating modes in turn: Internet Radio, Spotify, DAB radio and FM radio.
Pressing the **Media** button (on the remote control) gives you access to each of the operating modes in turn: Music Player, Bluetooth, Auxiliary Input, Optical 1, Optical 2, Coaxial and Line In.
3. Alternatively press and release the **Mode** button on the soundbar and then use the **Menu Up** or **Down** and **Select** buttons to select the desired operating mode.
4. Pressing and holding the **Info/Menu** button (on the remote control) or press and release the **Menu** button (on the soundbar) will access the menu system. The **Info** button also allows the display of information relating to the radio station or music file being played.
5. Many operations require the user to make a selection from the menu. Highlight the menu item using the **Menu Up** or **Down** buttons. Press and release the **Select** button to select that item. If there are more than six items in a menu, then the display will automatically scroll up or down so that the additional items become visible. A sliding bar on the right will give an indication showing the current portion of the menu that is displayed. If there are many items in a menu, then the soundbar allows the menu to 'wrap around' in either direction. This can make it easier to reach items at the end of a long menu, such as a list of countries or Internet radio stations.
6. If an error is made when navigating the menus, it is generally possible to go back to a higher level menu by pressing the **Back** button.

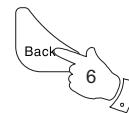
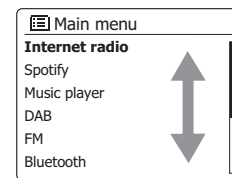
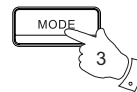
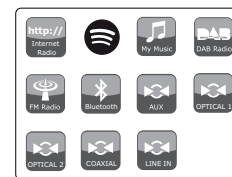
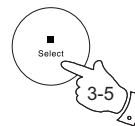
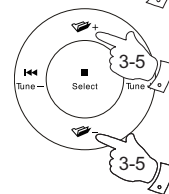
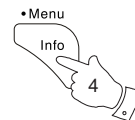
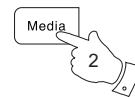
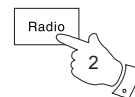

Installing the soundbar

If your TV sits on a TV table or cabinet, then it will often be simplest to place the soundbar on the same surface in front of the TV. Note that the soundbar's infra-red repeater function will allow your TV to respond to its remote control, even if its remote control sensor is obscured by the soundbar.

If your TV is wall mounted, then you may use the mounting brackets supplied with the soundbar to allow it to be fixed to the wall beneath the TV.

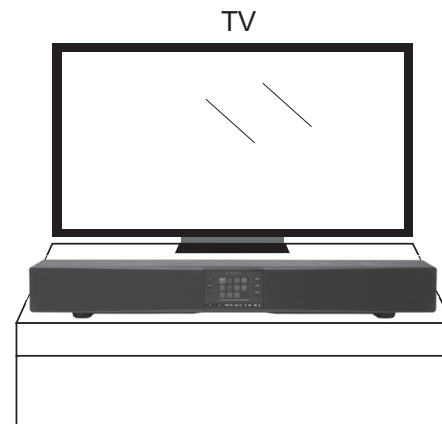

Cautions

- Do not place magnetically sensitive items near the soundbar such as a hard disc drive etc.
- Depending on the installation environment, it may be better to connect the soundbar and external devices (such as a TV) before installing the soundbar.
- Do not place the soundbar within 5cm (2") of the TV.
- Ensure the placement of the soundbar does not block access to any of the controls on your TV.
- Ensure that there is sufficient slack in any cables before moving the soundbar, or disconnect the cables before moving it.

Attaching the soundbar to the wall

The soundbar is supplied with mounting brackets to allow wall mounting.

1. Use the mounting template to mark the hole positions before drilling. Take care to ensure that there are no cables or pipes in the wall near the drilling locations.

IMPORTANT: Before drilling the holes and applying screws, please make sure that the screws are the appropriate length for the wall material. The screws must be able to support the weight of the installed soundbar. The soundbar and brackets weigh approximately 7 kg (15 lb).

2. Use screw fixings appropriate for the wall type. Do not overtighten the screws.

Note : Do not attach the soundbar to a wall that is made of weak materials such as plaster or wood paneling which could cause the soundbar to fall resulting in damage to the soundbar or personal injury.

3. The soundbar may be placed on the wall brackets as shown.

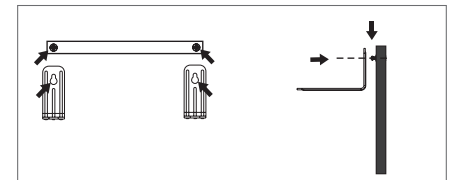
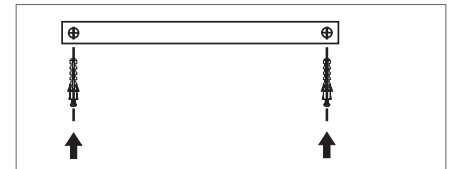
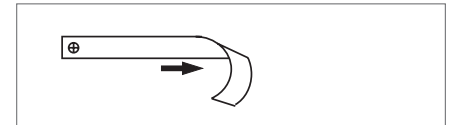
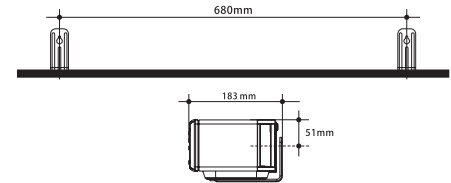

- Use the screws supplied with your soundbar to fix the underneath of your soundbar to the wall brackets. Do not overtighten.

Sangean will not accept any responsibility for any accidents caused by inadequate installations.

- To remove the soundbar from the wall carefully reverse steps 1-4 and put the wall brackets and screws in a safe place for future use.

Important:

Under no circumstances should the soundbar be placed on the brackets without the fixing screws also being used to secure the soundbar to the brackets. Vibration from the loudspeakers, or an accidental pull on the cables could cause the soundbar to fall resulting in personal injury or damaged to property.

It is the users responsibility to ensure that the fixings which are used to secure the brackets to the wall are suitable for the wall structure and are strong enough to support the weight of the soundbar, brackets and cables. The soundbar and brackets weigh 7 kg (15 lb).

Cautions for wall mounting

- Secure the soundbar firmly to the wall and check the soundbar is securely fixed to the wall after the installation. Incorrect or inadequate installation could cause the soundbar to fall and could result in damage to the unit or personal injury.
- Fix the cables in place where they will not become loose. If you accidentally catch a loose cable the soundbar may fall.
- Do not attach the soundbar to a wall that is made of weak materials such as plaster or wood panelled walls.
- Ensure that you use the correct size screws that can support the weight of the soundbar.
- Never place any items on the soundbar.
- Keep children away from the cables of the soundbar. Pulling the cables could cause the soundbar to fall.
- Do not install this equipment in a confined space such as a book case or similar unit.

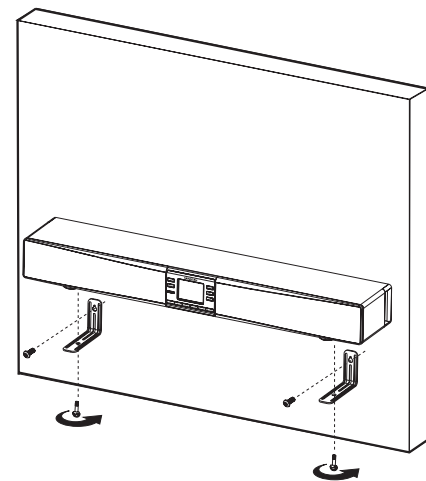
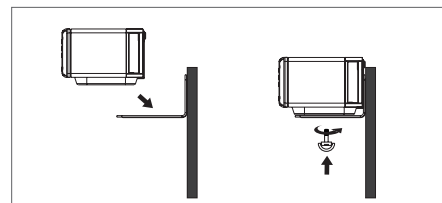

Connecting the soundbar

The soundbar has been designed to allow a variety of methods of connection to your TV and to other equipment.

In many cases, the TV will already be connected to a wide range of devices. Typically these may include satellite or cable TV receivers, DVD or Blu-ray players, games consoles, etc. Because the TV is already receiving both audio and video signals from these sources, the simplest and recommended way to connect the soundbar is to take its audio signal from the TV. This allows the TV to continue to act as the means of selection for these sources which helps to keep the operation of the system as simple as possible.

The soundbar can be used in this way with TVs which have either a digital audio output (typically an optical connection) or a "Line level output" (typically via a pair of phono sockets). Such outputs are designed to feed the audio signal to an external amplifier and are generally located behind the TV. You should refer to the documentation supplied with your TV for details of the audio connections available.

The use of your TV as the audio source for the soundbar is described on later section. The means connection of other devices is described in the subsequent pages. All of the connection illustrations are examples. There are many ways to connect different types of devices, and while we make some recommendations, you may choose to use different connections for your own installation.

Settings for digital audio devices

If the soundbar is connected to a device with a digital output, some configuration of that device may be required to ensure that audio signal is played correctly from the soundbar. Devices such as cable TV and satellite receivers, DVD and Blu-ray players generally allow their digital outputs to be set to output the audio either in stereo or in surround sound formats such as Dolby Digital or DTS. For use with the soundbar the digital output must be set to Stereo, sometimes also referred to as 'Downmix', 'PCM' or 'PCM Stereo' in the device settings. If this is not done, you may hear either a constant hiss or a loud buzzing instead of the expected audio.

Multi-room capability

For most of its operating modes, the soundbar is able to share audio with other connected multi-room products. So, for example, you could choose to listen to an Internet Radio station, to a Spotify selection, or to an external device such as an MP3 player, and have the sound played through the soundbar and shared with up to four other devices at the same time. The multi-room capabilities of the soundbar are explained in more detail in the 'Multi-room and UNDOK' section of this manual.

When using your soundbar while watching TV the multi-room function is normally disabled with the TV sound being only available from the soundbar. This is because the delays associated with sharing the sound with other multi-room devices and keeping them all in step would result in the sound being noticeably delayed compared to the image on the TV.

The soundbar's setting allow one input to be specified as the TV audio input. This input is then not shared with other multi-room devices and is played without significant delay. When playing from other sources to a group of multi-room products there is a very short delay added, but is it only about half a second. In this case, all the connected devices will play with their sound fully synchronised.

Details of the TV audio input selection and how it is configured are given in the 'TV audio options' section of this manual.

During installation

We recommend that the soundbar and any devices to be connected to it are switched off (or at least in standby) while the connections are made in order to prevent the possibility of damage or excessive volume from the speakers.

Audio Connection to your TV (recommended method)

The simplest and recommended way to connect the soundbar is to connect it to an audio output on your TV. Many modern TVs may have a digital output that can be used see **Option A** below.

An alternative output using a pair of audio sockets is sometimes provided, see **Option B**.

- Option A.** Connect the TV and soundbar using an optical cable. The connection type on the soundbar is often known as a Toslink socket. Remove any protective endcaps from the optical cable (if fitted) and check the orientation of the plugs before inserting one end into the TV and the other into one of the Optical Input sockets on the soundbar.
- Option B.** Connect the TV and soundbar using a stereo audio cable. The connection type on the soundbar is a pair of phono sockets (sometimes called RCA sockets), one socket for the left channel and one for the right. You may also use the 3.5mm stereo Auxiliary input socket if that is more convenient. We do not recommend making the connection to a headphone output from your TV since that will generally be at a signal level which is too low for this purpose.
- Use the TV Audio Input option in the system settings menu to specify which input is to be used for playing sound from the TV. Once this has been set, you simply press and release the Media button on the remote control to select the appropriate input on the soundbar for TV listening.

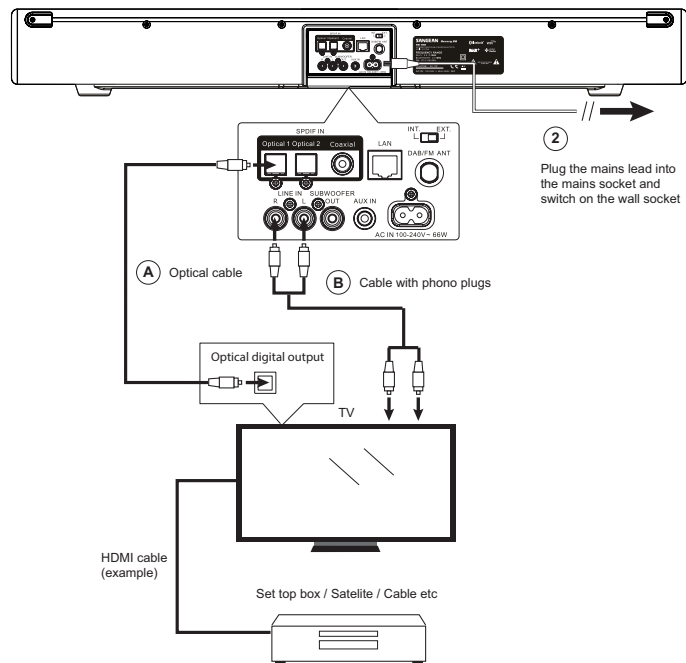

Alternative audio connection methods

In some cases, there may not be a suitable audio output available from the TV. If the TV is fed from a device such as a cable TV or satellite receiver, then that receiver may have an audio output which can be fed to the soundbar.

The example shows the TV connected to a cable TV or satellite receiver using an HDMI cable, and with the audio being fed separately to the soundbar, using either an analogue or digital connection. The choice of connection method will depend on the capabilities of the cable TV or satellite receiver.

1. **Option C.** Connect the cable TV or satellite receiver to the soundbar using an optical cable. The connection type on the soundbar is often known as a Toslink socket. Remove any protective endcaps from the optical cable (if fitted) and check the orientation of the plugs before inserting one end into the TV and the other into one of the Optical Input sockets on the soundbar. Ensure that the digital output is set to stereo.
2. **Option D.** Connect the cable TV or satellite receiver to the soundbar using a stereo audio cable. The connection type on the soundbar is a pair of phono sockets (sometimes called RCA sockets), one socket for the left channel and one for the right. You may also use the 3.5mm stereo Auxiliary input socket if that is more convenient.
3. Use the TV Audio Input option in the system settings menu to specify which input is to be used for playing sound from the TV. Once this has been set, you simply press and release the Media button on the remote control to select the appropriate input on the soundbar for TV listening.

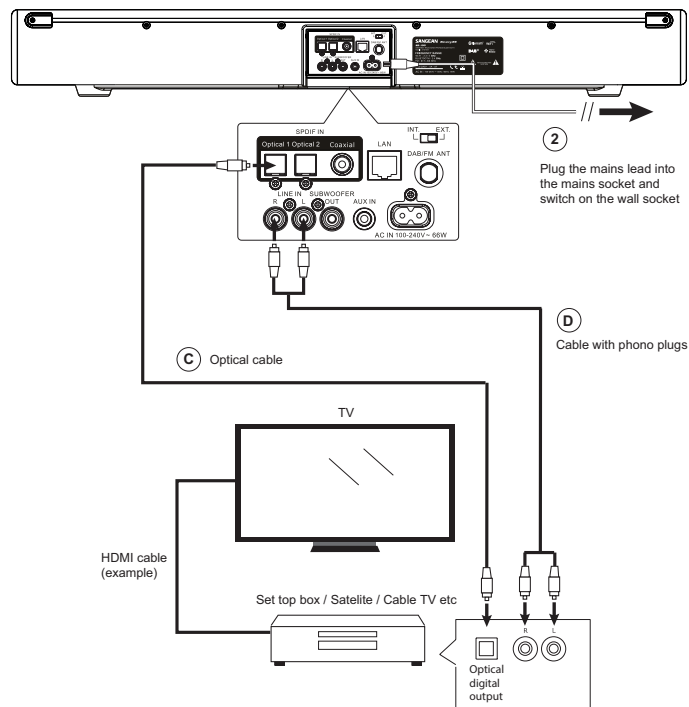

Using a DVD or Blu-ray player to play CDs

A device such as a DVD or Blu-ray player can be used to watch a film on the TV with the audio signal coming via the TV to the soundbar. If it is desired to be able to play other media such as CDs, then the additional inputs of the soundbar allow the player to be directly connected. In this way, the audio from the CD may also be shared with other connected multi-room products. The audio connection from the TV is then used when watching films from the player, while the connection from the player to the soundbar is used when playing CDs. This ensures that the audio for the films is not delayed by multi-room streaming, while the CD can be enjoyed around the house. In addition, the TV does not then need to be switched on.

The diagram shows the DVD / Blu-ray player connected to the TV using an HDMI connection (E). There is an optical connection from the TV to the soundbar (F) for sound when watching TV or films on DVD or Blu-ray discs.

For playing CDs the diagram shows the use of either an analogue connection (G) or a digital connection (H) from the DVD or Blu-ray player to the soundbar. You would only need to use one of these two options.

If you listen to DVD or Blu-ray discs with the soundbar connected using a digital signal (not via the TV), you should ensure that the player's output is set to stereo.

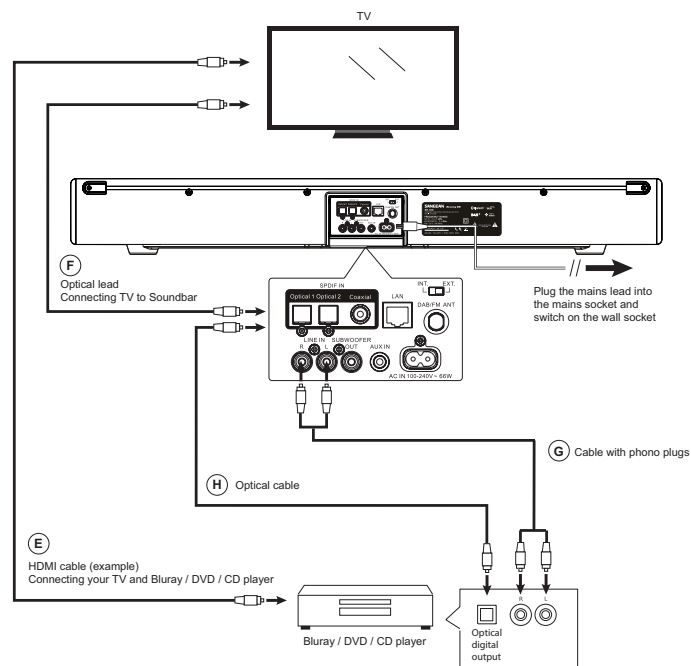

Using the Auxiliary input socket

Your Multi-room soundbar has an auxiliary input to allow audio from devices such as an MP3 player, CD or turntable to be played to other devices connected in a multi-room network.

1. Connect a stereo lead from the output of the chosen audio source to the Auxiliary Input socket located at the rear of the soundbar. Typically this lead will have a 3.5mm stereo plug at both ends.
2. Switch on your soundbar.
3. Press and release the **Media** button until the Aux In mode is selected.
4. Press 'Play' on the connected audio device if needed.
5. Depending upon the connected devices, you may need to adjust the volume of any products connected to the soundbar. If used as part of a multi-room group, you may also need to adjust the volume settings of other products in the group.

Note: If the Line Input sockets are not being used to receive the audio signal from your TV, then they may also be used as an additional auxiliary input.

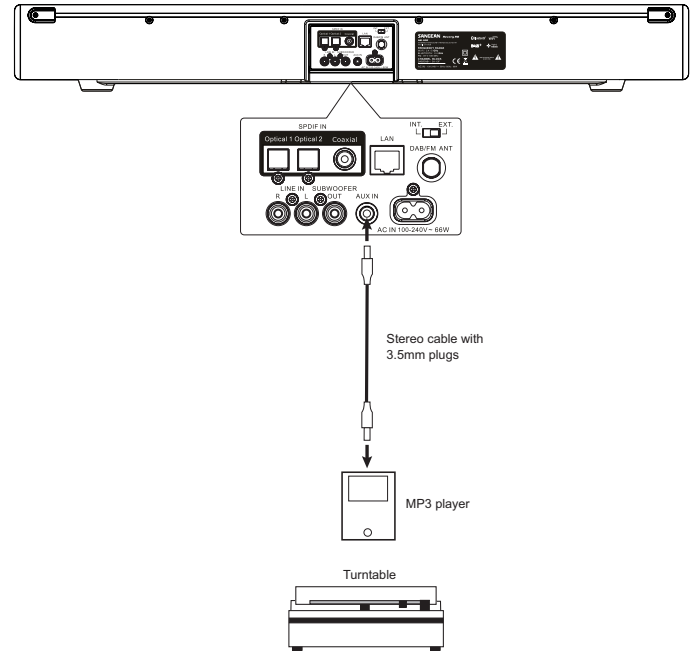

Connection to a external Subwoofer

Your multi-room soundbar has a built-in subwoofer capability which in many cases will provide more than enough bass. An external subwoofer can also be added if required, and the soundbar has an output specifically for this purpose.

We recommend that the soundbar and any devices to be connected to it are switched off (or at least in standby) while the connections are made in order to prevent the possibility of damage or excessive volume from the speakers.

1. Connect a lead from the **Subwoofer output** socket located at the rear of the soundbar to the **input** socket on your external subwoofer.
2. Switch on your soundbar and external subwoofer.
3. The subwoofer volume control on the soundbar remote control adjusts levels of the internal subwoofer function and also the signal levels to an external subwoofer.

You should refer to the documentation supplied with your external subwoofer to determine how to connect to it and how to configure its setting. The external subwoofer output on the soundbar is primarily active for frequencies below 100Hz.

Note: If your soundbar or subwoofer is located in the corner of a room (especially on the diagonal) then you may need to reduce the subwoofer volume setting on the soundbar. This is because the reflections from the walls around the corner will tend to enhance the bass response of the system. Conversely, in a large open area, you may wish to increase the subwoofer volume setting on the soundbar.

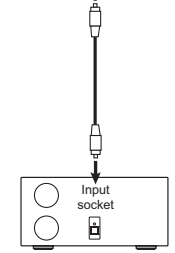
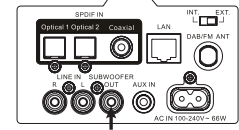
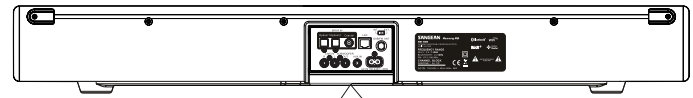

External Subwoofer

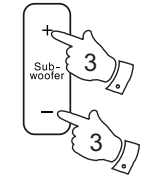

Infra-red repeater function

Your Multi-room soundbar has an infra-red pass through facility for when the soundbar is placed in front of the TV's remote control sensor.

The soundbar will receive the TV remote control signals at the front of the unit and will then retransmit the signals from the infra-red repeater strip on the rear so that they may be received by the TV.

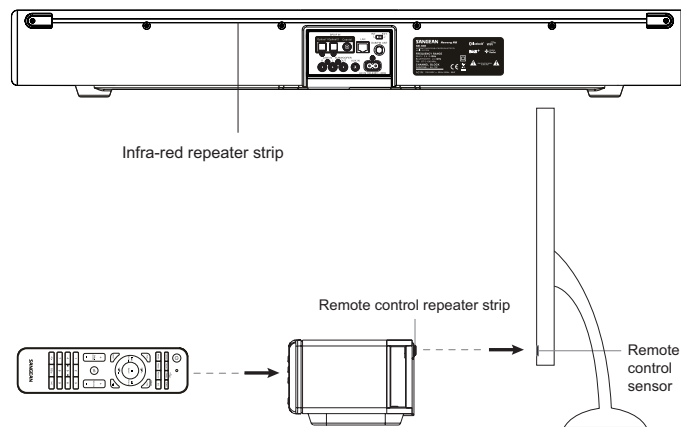

Antenna switch

Your soundbar has a built-in antenna for DAB and FM radio reception. However, the typical location of a soundbar, close to a large-screen TV and perhaps also close to other equipment such as a cable TV or satellite receiver, DVD or Blu-ray player, etc., is a poor location for radio reception. Therefore, we recommend that for radio listening you use either the Internet Radio function, or that if good DAB or FM radio reception is required then an external aerial is used, perhaps installed in a loft or on the roof. The antenna switch should be used to select the internal antenna or to use the external connection as needed.

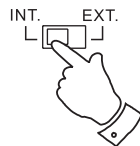

Configuration

Connecting your soundbar to your computer network

1. Place your soundbar on a flat surface or wall mount as previously described. Then plug the mains lead into the mains socket located at the rear of your soundbar ensuring that the plug is pushed fully into the socket.
2. If you wish to use a wired network connection, plug the Ethernet cable into the RJ-45 socket at the back of the soundbar.
3. Plug the other end of the mains lead into a wall socket and switch on the wall socket.

IMPORTANT:

The mains plug is used as the means of connecting the soundbar to the mains supply. The mains socket and any multi-way mains block or appliance coupler used for the soundbar must remain accessible during normal use.

In order to disconnect the soundbar from the mains, the mains plug should be removed from the mains socket completely.

4. When you apply power, the display on the soundbar will light up and say: 'SANGEAN'. If this is the first time that you use your soundbar (or after a Factory Reset) the display will show "Setup wizard" and "YES" will be highlighted on the screen. Press the **Select** button to start the setup wizard and proceed to step 5.

If press the Menu Left or Right buttons to highlight 'No' and press the select button The screen will ask if you wish to run the setup wizard again at the next start up. This will lead to the main menu.

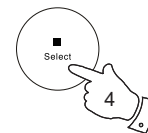
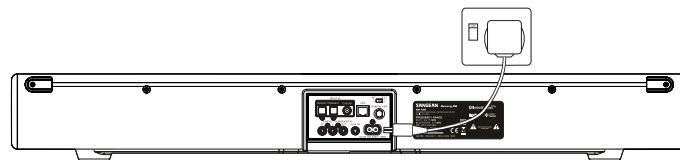

- Press the **Menu Left** or **Right** buttons to highlight the desired clock format (either 12 or 24 hour) then press the **Select** button to enter your selection.
- Next, the way in which the soundbar updates its clock is set. A menu allowing you to specify the auto-update option for the clock will be shown. The 'Update from Network' option will be best for most users.
- Press the **Menu Up** or **Down** buttons to choose an auto-update option for the clock. This can be updated from DAB or FM radio, from the Network, or not updated. The default is to auto-update from the network. If you choose another option go to 'Connecting to your computer network'. Otherwise you will first need to select the correct time zone and daylight savings setting, see the next steps. If you choose 'No update' you will need to set the clock manually later. Press the **Select** button to confirm your choice.
- Press the **Menu Up** or **Down** buttons to highlight the time zone for your current location. Press the **Select** button to enter the setting.
- You will then need to set the Daylight Savings option according to your location (Daylight Savings is also known as Summer/Winter time or BST/GMT adjustment). Press the **Menu Left** or **Right** buttons to highlight 'ON' or 'OFF' as required. The asterisk shows the current setting. Press the **Select** button to enter the selection. In the UK, 'ON' is equivalent to British Summer Time and 'OFF' is equivalent to Greenwich Mean Time.

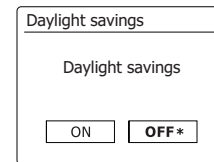
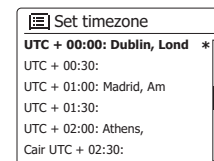
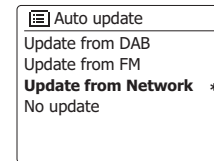
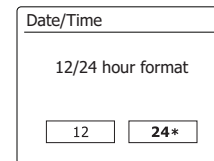
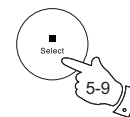
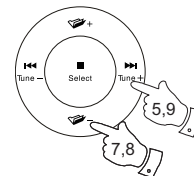

10. The display will show a list of regional options for the WiFi configuration.

Press the **Menu Up** or **Down** buttons to highlight the required region and then press the **Select** button to make the selection. Do this even if you are planning to use the wired Ethernet connection. Your soundbar will then scan for available WiFi networks.

11. The soundbar will enter the Network Settings Wizard and will display 'Scanning...'. The soundbar will automatically scan both the 2.4GHz and 5GHz WiFi bands. After a short while the display will show a list of the available WiFi networks. If you are intending to use the WiFi connection, go to step 12.

To use the Ethernet connection to your router (with automatic configuration), press the **Menu Up** or **Down** buttons to point to the '[Wired]' menu item. Press the **Select** button and the soundbar will attempt to connect.

If your network allows automatic configuration (which is normal) the soundbar will acquire a network address. The screen should say 'Connecting...', and then 'Setup wizard completed'. Press the **Select** button to exit the setup wizard and show the Main menu.

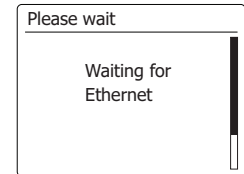
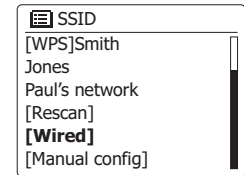
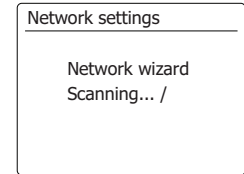
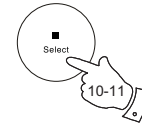
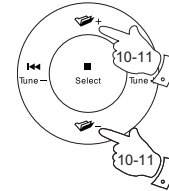

There are two indicator lights incorporated into the RJ-45 connector. If you have problems with your wired connection, they may help you to identify the possible cause of the problem.

Yellow ON = Link established; OFF = no connection Green Flashing = Data transfer

If your network does not support automatic configuration or if you wish to set it up manually then you should select '[Manual config]' instead of selecting '[Wired]' in the Network Wizard.

12. If you plan to use a WiFi connection, you will first need to identify your network in the list of network names presented by the Network Wizard. If no networks are found then you may have to get your wireless router working (please see the instructions supplied with it) or you may be too far from the router.

When the soundbar finds your wireless network, it displays the Network Name (SSID) for the wireless access point on the screen. This is a name that is allocated to the access point in your router by the person who set up the network - for example: 'Jones family' or 'Paul's network'. Routers supplied by Internet Service Providers often have the default name of the WiFi network provided on a label or card for easy reference (e.g. BTHub - 1234, virginmedia 1234567). If the router supports WiFi Protected Setup, then '[WPS]' will be shown in front of the SSID.

It is possible, and in some locations highly likely, that your soundbar will find more than one wireless network, in which case you should choose which one you need to connect to.

13. Press the **Menu Up** or **Down** buttons to see the SSID for each wireless network that has been found. If your network is shown proceed to step 15 on the next page. If it is not shown then proceed to step 14.

If you make a mistake at any point, use the **Back** button to go back to the previous screen.

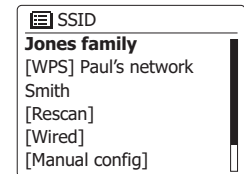
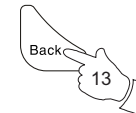
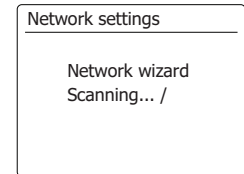
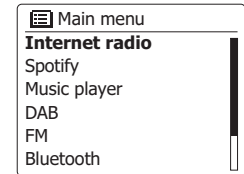
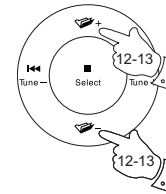

14. If your network is not found, it may be because the router is configured not to broadcast the SSID. You should then use the **Menu Up** or **Down** and **Select** buttons to highlight and select the '[Manual config]' option in order to enter the network details manually. This is described in 'Manual Network Configuration'.

If your network name is being broadcast, and it was not found, then try re-scanning (press the **Back** button), and if necessary try moving your soundbar to a location closer to your access point / router.

15. When the SSID for the wireless network you wish to connect to is highlighted on the screen, press the **Select** button. If WiFi Protected Setup (WPS) was indicated, you will see an additional menu at this point, otherwise proceed to step 16.

Choose one of the WPS menu options as required for your router (WPS may be via push button, or using an identification number).

'Push Button' - the display prompts you to press the WPS button on your router and then the **Select** button on the soundbar. The two devices should then connect with the encryption key sent automatically to the soundbar.

'PIN' - the display shows an identification number which you must enter into your router using a web browser (refer to your router's user documentation). You should then press the **Select** button on the soundbar. The two devices should then connect with the encryption key sent automatically to the soundbar.

'Skip WPS' - if you wish to enter the encryption key yourself (or if it was previously entered).

If you chose Push Button or PIN the screen will then show 'Connecting...' and then 'Setup wizard completed'.

Press the **Select** button to exit the setup wizard.

16. If your network is configured without an encryption key, the screen should say 'Connecting...', and then 'Setup wizard completed'. Press the **Select** button to exit the setup wizard and show the Main menu. If this is the case then you have successfully connected your soundbar to your network.

17. If the screen displays 'Key:', it is because the network is using one of the encryption systems: Wired Equivalent Privacy (WEP) or WiFi Protected Access (WPA). You will need to enter the correct WEP or WPA key into the soundbar to allow it to communicate with your wireless network. If you do not have the WEP or WPA key, then you should obtain it from the person who set up your network. Some wireless routers may come with an encryption key already set up by the supplier, in which case you should refer to the documentation provided with it. WPA is used here to also include WPA2.

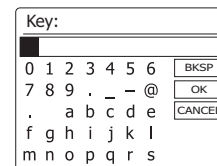
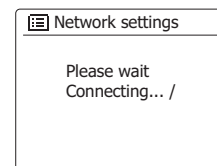
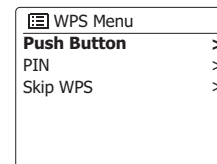
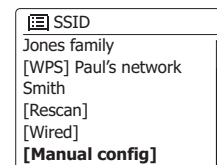
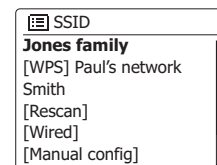
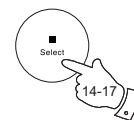
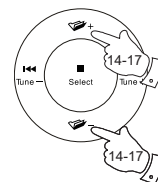

WEP keys are 10 or 26 characters long (using 0 - 9, and A - F). Some wireless routers can also use pass-phrases for WEP but these are not supported by the soundbar. WPA keys are usually set up using a pass-phrase of between 8 and 63 characters. Your soundbar accepts pass-phrases for WPA keys.

18. To enter the WEP or WPA key, characters are selected and entered using the **Menu Up** or **Down, Left** or **Right** and **Select** buttons. The highlight scrolls through the available characters as well as the three controls on the right. The character currently highlighted will be entered when you press the **Select** button.

Do this as needed until the complete key has been entered. Remember, WEP keys only use the numbers 0-9 and letters A-F. WPA keys are sensitive to upper and lower case characters. You must enter the key exactly or the soundbar will not connect to the network.

The three controls on the right-hand side of the screen have special functions. You can quickly access these by pressing the **Info** button and then using the **Menu Up** or **Down** and **Select** buttons as needed:

- select '**BKSP**' to erase a character just entered (long press to clear); **Info** again to continue
- select '**OK**' when the complete key has been entered
- select '**CANCEL**' to cancel and re-run the Network Wizard

If a WEP or WPA key has previously been entered for the selected SSID then the display will show 'Key: [Set]'. If you have previously entered a different key, you must clear this by selecting the '**BKSP**' symbol. This will remove the '[Set]' indication.

After the final character of the WEP or WPA key has been entered, highlight the '**OK**' symbol and press the **Select** button. The screen will show 'Connecting...' and then 'Setup wizard completed'. Press the **Select** button to the exit setup wizard. The soundbar should now be able to connect to the network.

19. Once you have connected your soundbar to the network (and therefore also to the Internet) it will display the Main menu. Press the **On/Standby** button to put the soundbar into Standby mode. It should then display the time as obtained from the Internet. If the time display is not correct for any reason, it can easily be adjusted later, see 'Manually setting the clock'.

If you have followed the steps on the preceding pages successfully, your soundbar will have connected to your router, and then made a connection to the Internet and set its clock. If this is the case, then you can try listening to radio stations via the Internet.

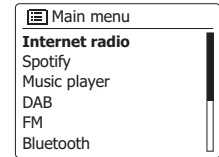
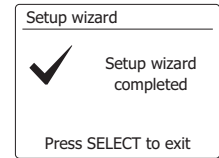
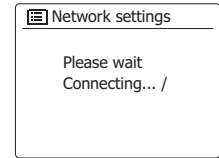
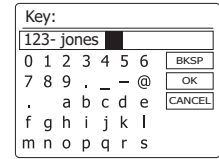
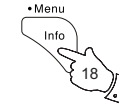
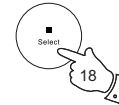
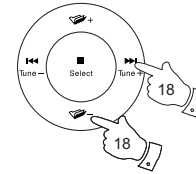

Changing the network connection

In the sections above, you chose how your soundbar would be connected to your network, either using a WiFi connection or using a wired Ethernet cable. From time to time, you may find that you need to connect to different computer networks. The Network Settings menu allows you to change your soundbar's network settings, scan for an alternative wireless network, or to manually configure the network parameters.

The steps outlined below describe how you can do this - see also the section 'Network profiles'.

Configuring the soundbar to use an alternative WiFi connection

1. From the Network Settings menu select 'Network wizard'. This will present you with details of any WiFi networks that are found. Scroll down the list using the **Menu Up** or **Down** buttons to the desired network name. Press the **Select** button to select this network.

The soundbar will then use its WiFi system to communicate with the network. Depending on the settings for the new network you may need to enter an encryption key. By default the soundbar will then acquire an IP address and other network settings from the network's router using DHCP (Dynamic Host Configuration Protocol).

Configuring the soundbar to use the wired Ethernet connection

2. Connect your soundbar to your router using an Ethernet cable plugged into the RJ-45 socket at the back of the unit. From the Network Settings menu select '*Network wizard*'. This will display a list of any WiFi networks that are found. Scroll down the list and select the '*Wired*' option.

The soundbar will then use its Ethernet connection to communicate with the network. By default the unit will then acquire an IP address and other network settings from the network's router using DHCP .

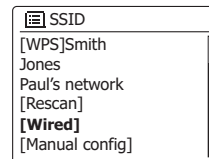
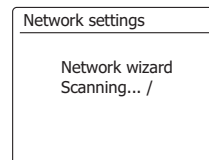
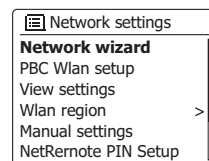
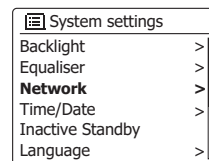
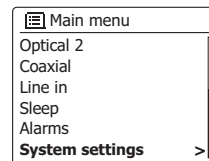

Using the UNDOK app

1. Download the UNDOK app

Download and install the UNDOK app to your Android or iOS device from the Android Google Play store or Apple iTunes App store.

- Make sure the UNDOK app installed on your device has the latest version.
- The app may update a new version on the internet from time to time, so this app may have been changed slightly since these instructions were written.

Note: The images used below extract from Android device. If your device uses iOS Apple or different UNDOK version, the display may be slightly different.

2. Open the UNDOK app and turn on the Sounbar, making sure your Sounbar and smartphone are connected to the same WiFi network.
3. The device will be listed on the screen of the smart phone. Select your Sounbar, for example "Sangean SB-100 xxxxxxxxxxxx" (the 12 digit alphanumeric code is the MAC address of your radio) to establish a connection between UNDOK and your Soundbar.
4. If using the Sounbar for the first time or after performing a factory reset, turn on the Sounbar and open the UNDOK app, you can also select the 'SET UP AUDIO SYSTEM' or 'AUDIO SYSTEMS TO BE SET UP' on your smartphone. The UNDOK app has a setup wizard to help configure suitable audio device to connect to your WiFi network.
5. Go to WiFi settings of the smart phone to choose for example 'Sangean SB-100 xx:xx:xx:xx:xx:xx'. Go back to UNDOK app, the app will show a list of suggested audio systems to setup. Your Soundbar will normally appear in this list as "Sangean SB-100 xx:xx:xx:xx:xx:xx". Select the Soundbar to be setup.

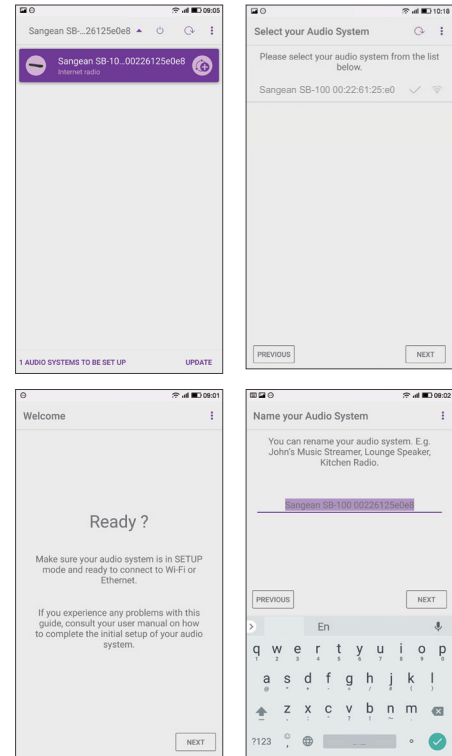

6. Use the app to complete Soundbar the setup, including giving the Soundbar a name if needed.
7. Select the preferred method to connect your Soundbar to the network. If you wish to connect using an Ethernet cable, please refer to the later section 'Using an Ethernet connection'.
8. For a WiFi connection the app will ask you to choose a WiFi network and enter the appropriate password. Your Soundbar will connect to your network.

Note:

If when setting up your Soundbar your Android device complains that it cannot connect to the internet this is because it is temporarily connected directly to your Soundbar. You should ignore this warning message.

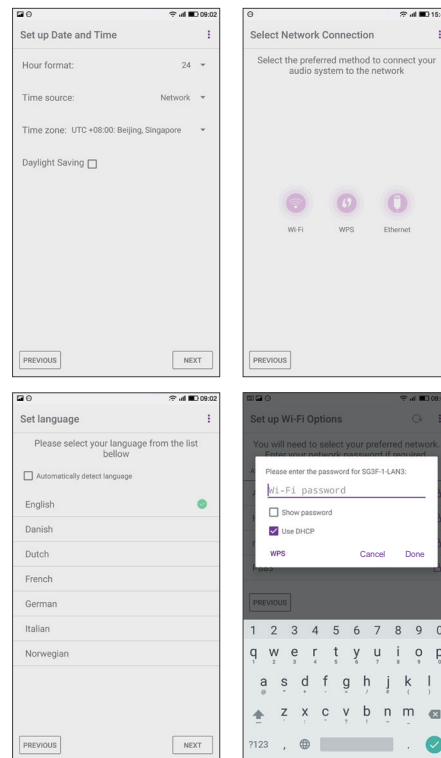

Network remote control options

Network PIN setup (PIN number)

Your soundbar has the option of being controlled by an application installed on an Apple iPhone, iPod touch, iPad or equivalent Android device. The PIN number facility allows you to ensure that your soundbar can only be controlled by your own device rather than someone else's.

The remote control application is called UNDOK, by Frontier Silicon Limited, and is available from the Apple App Store and Google Play for your device.

UNDOK will try to use the default PIN of '1234' to control your soundbar.

You may change the PIN if desired using the 'NetRemote PIN Setup' option in the Network settings menu. The updated PIN should then be used in the UNDOK app to allow the app to reconnect to the soundbar. The app will prompt you for the PIN as needed.

Using an Ethernet connection

If you choose to connect your soundbar to the network using a wired Ethernet connection, then an Ethernet cable of the appropriate length will be needed (cable not supplied). The app will offer you an option to connect using Ethernet during the setup procedure.

1. Connect the Ethernet cable to the RJ45 Ethernet socket on the back of your soundbar.
2. Select the Ethernet option on the UNDOK app and follow the onscreen guide.

In situations where there are many WiFi networks in use, it is possible that multi-room performance of the product may be improved by using the ethernet connection.

If it is intended to listen to FM radio extensively, then there may be benefit in using a shielded Ethernet cable since this may reduce possible interference to the soundbar.



Control via the UNDOK app

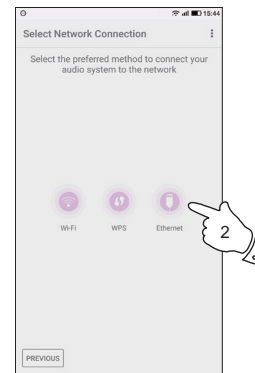
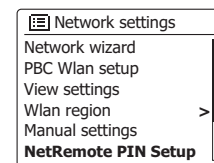

Internet Radio

Internet Radio - the basics

Before you can use your soundbar to listen to broadcasts via the Internet, it is necessary to have connected it to your computer network using either the wireless (WiFi) connection or the wired Ethernet connection (RJ-45 socket) located on the back of the unit.

There are literally many thousands of radio broadcasts available via the Internet as well as 'Podcasts'. Your soundbar provides several ways of searching for broadcasts in order to make finding and choosing them easier. Once you have found the radio stations that you like, you may either store them as presets within the soundbar, or add them to a list of your favourite stations which your soundbar can access. The number of presets is limited (there are ten presets on the soundbar) but you can store as many favourites as you like.

You may search for an Internet radio station by Location. If you know the name of the station and the country from which a station is broadcast this may be the easiest method to find a station. It is also a great way to experience radio from other parts of the world.

You may also search for an Internet radio station by Genre. If you prefer a particular type of music, Blues for example, you may search for a radio station that broadcasts that type of music, and you can choose from a list of Blues radio stations regardless of location, or taking location into account.

If you know part of the name of an Internet radio station, you can enter it into the soundbar and it will search for stations that match that name. This can be helpful if you are unsure of the location or genre of a particular station.

The SB-100 soundbar connects to a radio station database which serves many users in many countries. This means that there is a very wide range of programme content available. You can also search for stations which have been recently added to those available (new stations) or you can search for the most popular.

Selecting a radio station by location

1. Press the **On/Standby** button to switch the soundbar on. Then press and release the **Radio** button to select the Internet Radio mode display.
2. **Press and hold** the **Menu** button to enter the main Internet Radio menu. Press and release the **Menu Up** or **Down** buttons until 'Station list' is highlighted on the display and then press and release the **Select** button to select the option.
3. Press the **Menu Up** or **Down** buttons until 'Stations' is highlighted on the display and then press and release the **Select** button.
Note that the menu may offer one or more local selections based upon the country in which the unit is being used, according to your internet IP address ('United Kingdom' and 'BBC' stations, for example).
4. Press the **Menu Up** or **Down** buttons until 'Location' is highlighted on the display and then press and release the **Select** button.
5. Press the **Menu Up** or **Down** buttons to scroll through the list of continents. When the desired continent is highlighted press and release the **Select** button to enter your selection.
6. The display will show a list of countries within the chosen continent. If there are many countries shown you can scroll through the list continually in either direction. For example, if the chosen continent was Europe, then to find the United Kingdom scroll up from the top of the list to the bottom by pressing and releasing the **Menu Up** button. Press and release the **Select** button to choose the desired country.
7. You will typically find that you then have the option to select either 'All Stations' or one of a number of categories. The lists are always sorted alphabetically, and long lists will wrap around from top to bottom or bottom to top.

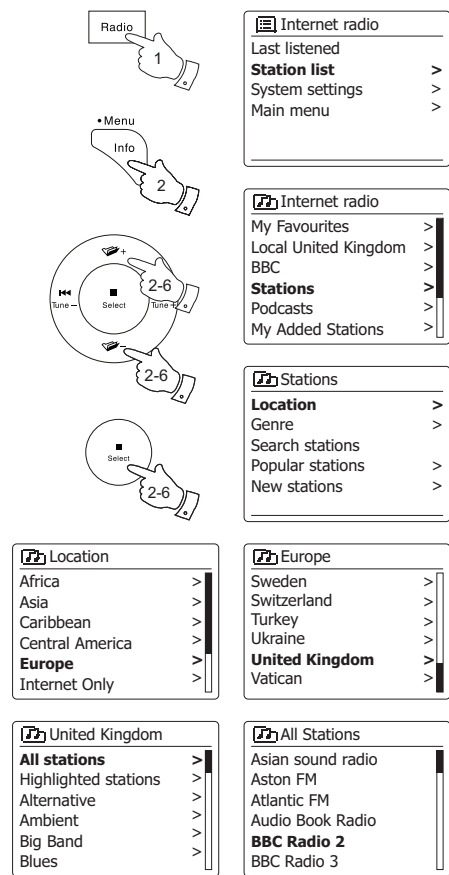

Selecting a radio station by location - cont.

8. Press and release the **Menu Up** or **Down** buttons to highlight your chosen radio station and then press and release the **Select** button to enter your selection. The display will show 'Connecting...' while the soundbar connects to the new station. The station should then start playing. Adjust the volume as needed.

9. If the station has on-demand content, that is, it gives the option of listening to programmes which have already been broadcast or to Podcasts, there will be an additional screen showing the radio station name as well as a 'Podcasts' option.

These are selected using additional menus, determined by the radio station and the content. There may simply be a list of programmes, or there may also be options to choose from broadcasts on particular dates or days of the week. The examples shown here are typical. Podcasts can also be accessed separately from the main Internet Radio menu.

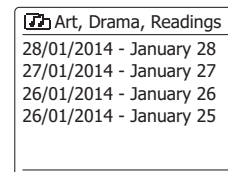
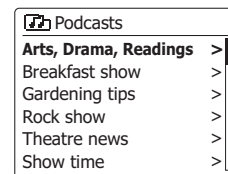
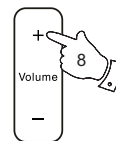
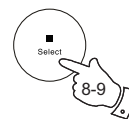
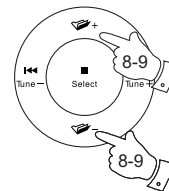

If your soundbar cannot connect to a radio station

Note: If your soundbar is unable to connect to an Internet radio station it will generally either display 'Network Error' or 'Stopped'. This can be for many reasons, but typically will be due to one of the following:

The radio station may not be broadcasting at the present time.

The radio station may not be able to accommodate any more connections from internet listeners.

The broadcaster may limit listening to specific countries or regions.

There may be network congestion (either locally or at a distance) which is affecting the reliability of the connection.

If your soundbar can connect, but the audio is not continuous and the radio keeps having to reconnect, this may be due to the radio station only having limited connection capacity.

Selecting a radio station by genre

1. Press and hold the **Menu** button to enter the main Internet Radio menu. Press the **Menu Up** or **Down** buttons until 'Station list' is highlighted on the display and then press and release the **Select** button.
2. Press the **Menu Up** or **Down** buttons until 'Stations' is highlighted on the display and then press and release the **Select** button.
3. Press the **Menu Up** or **Down** buttons until 'Genre' is highlighted on the display and then press and release the **Select** button.
4. Press the **Menu Up** or **Down** buttons to scroll through the list of content types. This menu is normally cyclic - you can scroll the list continually in either direction. When the chosen genre is highlighted, press and release the **Select** button.
5. You then have the choice of 'All Stations' of the chosen genre, or a list of countries. Note if a country is not shown then the station may still appear in the 'All Stations' list. Press the **Menu Up** or **Down** buttons and press and release the **Select** button to choose as needed.
6. A list of radio stations is then shown. Press the **Menu Up** or **Down** buttons until the desired station name is highlighted on the display.
7. Press and release the **Select** button to select the station. The display will show 'Connecting...' while it finds the new station. If the radio is unable to connect this may be for one of the reasons explained on the preceding page.
8. Adjust the **Volume** as needed to set the listening level.

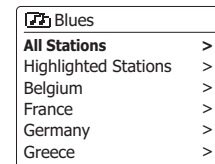
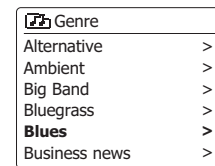
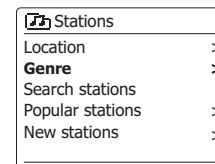
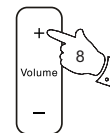
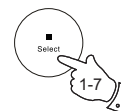
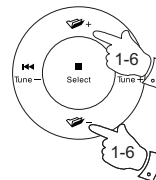
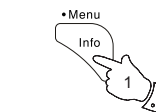

Searching for a radio station by name

There may be occasions when you know the name of a radio station but you do not know the location or genre. This facility allows you to search for the station using a part (or parts) of the radio station name.

1. **Press and hold** the **Menu** button to enter the main Internet Radio menu. Press the **Menu Up** or **Down** buttons until 'Station list' is highlighted on the display and then press and release the **Select** button.
2. Press the **Menu Up** or **Down** buttons until 'Stations' is highlighted on the display and then press and release the **Select** button.
3. Press the **Menu Up** or **Down** buttons until 'Search stations' is highlighted on the display and then press and release the **Select** button.
4. To enter the search word(s) press the **Menu Up** or **Down**, **Left** or **Right** to highlight each character for the search in turn, and press and release the **Select** button to enter. If you make an error press and release the **Menu Up** or **Down** buttons or use the **Info** button to access the delete character **[BKSP]** on the screen and then press and release the **Select** button. Press and release the **Menu Up** or **Down** buttons or press **Info** again to go back to the character selection. After the final character of the search has been entered, use the **Info** button and then the **Menu Up** or **Down** buttons to highlight the **[OK]** symbol on the screen and then press and release the **Select** button to finish.
5. The soundbar will search for radio stations that match your search data. If you include a space between two search items the soundbar will look for station names which include both items. Thus a search for 'ROCK 100' could find a station called '100 Classic Rock Hits' as well as a station called '100.FM Rocks'.
6. Press the **Menu Up** or **Down** buttons to highlight the station that you wish to listen to and press and release the **Select** button to confirm your choice. The display will show '*Connecting...*' while it finds a new station.

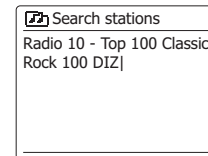
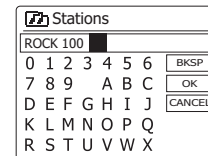
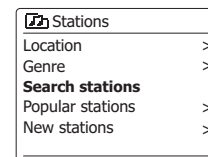
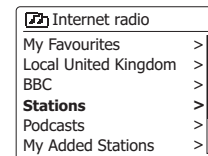
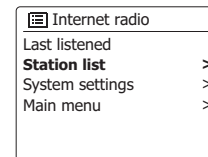
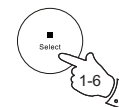
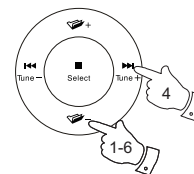
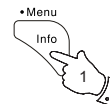

Selecting a new or popular station

As described in the section 'Internet Radio - the basics', your soundbar connects via the Internet to a database of radio stations. This option is provided to highlight stations which are newly added to the list of those available, or stations which are particularly popular with listeners around the world. Your soundbar allows you to easily choose stations from these two categories, using menus very similar to those used when finding stations by location and genre.

1. **Press and hold** the **Menu** button to enter the main Internet Radio menu. Press the **Menu Up** or **Down** buttons until 'Station list' is highlighted on the display and then press and release the **Select** button.
2. Press the **Menu Up** or **Down** buttons until 'Stations' is highlighted on the display and then press and release the **Select** button.
3. Press the **Menu Up** or **Down** buttons until 'Popular stations' or 'New stations' is highlighted on the display. Press and release the **Select** button to enter your choice.
4. Press the **Menu Up** or **Down** buttons to highlight the station that you wish to listen to and then press and release the **Select** button to enter your choice. The display will show 'Connecting...' while the new station is found.

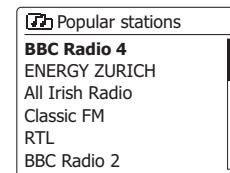
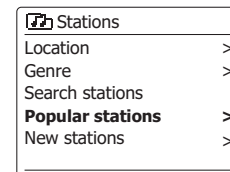
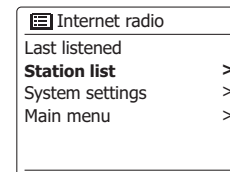
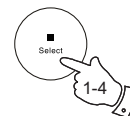
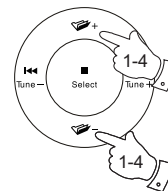
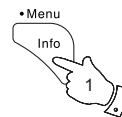

Selecting a podcast

Radio broadcasters and individuals may make programmes which are intended normally to be downloaded into a computer or copied onto a portable media player. These are commonly known as Podcasts.

Podcasts are also accessible using the Podcasts option on the *Stations* menu.

1. **Press and hold** the **Menu** button to enter the main Internet Radio menu. Press the **Menu Up** or **Down** buttons until 'Station list' is highlighted on the display and then press and release the **Select** button.
2. Press the **Menu Up** or **Down** buttons until 'Podcasts' is highlighted on the display and then press and release the **Select** button.
3. You may then search by location, genre, or using part of the name of the podcast. The searches operate in exactly the same way as when searching for a conventional radio station. Searching by location is done first by continent, then by country. You may then list 'All shows' or search within a country by genre. Searching by genre is more direct, since once the genre is chosen the next menu display shows a list of available podcasts. Searching by name operates in the same way as when searching for a named radio station, selecting the **OK** symbol when you have entered the text. You may enter one or more pieces of text which will be used for the search.
4. Press the **Menu Up** or **Down** buttons and then press and release the **Select** button to confirm your chosen podcast. The display will show 'Connecting...' while it finds the new programme.

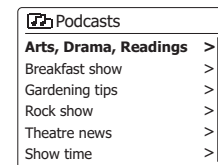
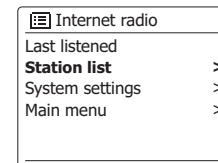
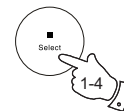
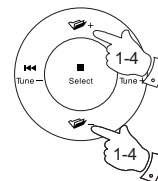
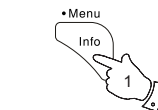

Presetting stations

With so many Internet radio stations available, it is desirable to have a means of rapidly selecting the stations that you listen to most frequently. Your soundbar has ten memory presets for Internet radio which can easily be set to store the details of any Internet radio station or podcast. The radio station presets are retained even when the soundbar is switched off.

Please see also the sections 'Last Listened' and 'Configuring My Favourite Stations'.

Storing a preset 1-10 using the remote control

1. Press the **On/Standby** button to switch on your soundbar. Tune to the required station using one of the methods described on the preceding pages.
2. To store the currently playing radio station as a preset, **press and hold** the required **Preset** button (1 - 10) on the remote control until the display shows 'Preset stored'. The station will be stored using the chosen preset button. Repeat this procedure as needed for the remaining presets.
3. Stations that are already stored in the presets may be over-written by following the procedure described above.

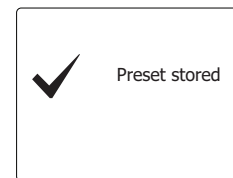
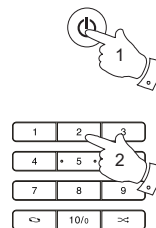

Recalling a preset 1-10 using the remote control

1. Press the **On/Standby** button to switch on your soundbar. Select the Internet Radio mode using the **Radio** button.
2. Momentarily press and release the required **Preset** button on the remote control. Your soundbar will then connect to the station stored in the preset memory. The preset used will be shown at the bottom of the display screen.

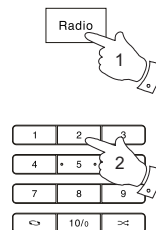

Storing a preset using the unit

1. Press the **On/Standby** button to switch on your soundbar. Tune to the required station using one of the methods described on the preceding pages.
2. **Press and hold** the **Preset** button. The display will show a 'Save to Preset' menu.
3. Press the **Menu Up** or **Down** buttons to scroll through the preset list until you reach an unused preset or a preset that you wish to change. Press and release the **Select** button to store the preset. 'Preset stored' will be shown on the display. Repeat this procedure as needed for the remaining presets.
4. Stations which are already stored in the presets may be over-written by following the procedure above.

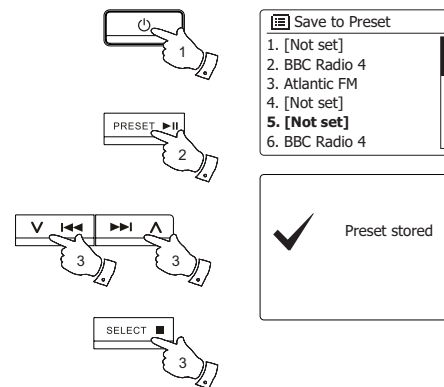

Recalling a preset using the unit

1. Select the Internet radio mode.
2. Press and release the **Preset** button to display the 'Recall from Preset' menu.
3. Press the **Menu Up** or **Down** buttons to select the desired preset station. Press and release the **Select** button.

Your soundbar will then connect to the station stored in the preset memory. The preset used will be shown at the bottom of the display screen.

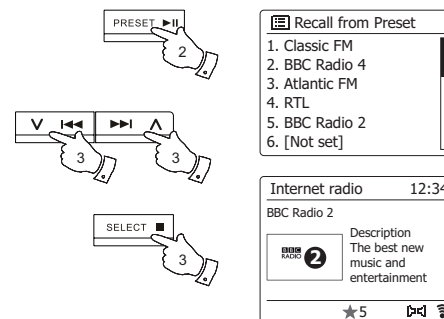

Display modes

Your soundbar has a range of display options when in Internet Radio mode. Note that not all information may be available for all Internet radio stations.

1. Press and release the **Info** button to cycle through the different options.

| | |
|-----------------|--|
| Description | Displays information about the radio station or scrolling text messages such as artist/track name, phone number etc. |
| Genre | Displays programme type information e.g. Pop, Classic, News, etc. and the location of the current radio station. |
| Reliability | Displays the reliability of the data stream from the station currently being received. |
| Format | Displays the bit rate and format of the station being received. |
| Playback buffer | Displays status when connecting to and playing a radio station. This indicates the reliability of the data stream to your radio. If there are no bars shown to the right of the dividing line then the data stream reliability may be poor and you may find that there are many breaks in the audio. |
| Date | Displays the current date. |

Additional or alternative information may be displayed when listening to Podcasts. Categories displayable can include...

| | |
|--------------|------------------|
| Episode name | Show description |
| Show genre | Show language |
| Episode URL | Bit rate |
| Codec | Sampling rate |

Whenever the soundbar is displaying an information screen (as opposed to a menu screen), the time is displayed in the top-right corner of the display, and a WiFi strength or Ethernet connection indicator is shown in the bottom-right corner.

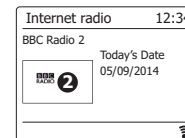
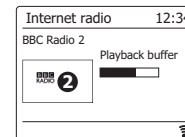
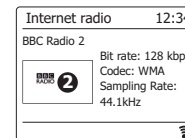
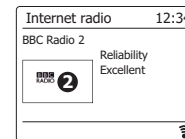
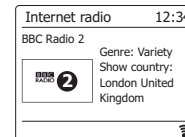

Customising your soundbar

In addition to storing your favourite radio stations in the radio presets, your soundbar allows you to create customised lists of stations which can appear in two special menus on the soundbar called 'My Favourites' and 'My Added Stations'.

Your soundbar uses a database which is accessed via the Internet in order to find out which radio stations are available and how it should connect to them. You are able to add your personal selections to this database. These will only be accessible by you using your PC or your soundbar. You can choose the stations which will appear in the 'My Favourites' menu from the large selection already listed. Additionally, if you find a radio station that is not listed then you may also add the Internet address (URL) of the station's audio stream to your selection. It will then appear on your soundbar via the 'My Added Stations' menu item.

Registering an account

1. Open the web site <http://www.wifiradio-frontier.com> using the Internet browser on your computer. Click on the 'Register here' link and follow the on-screen instructions to register an account. During the registration process the web site asks for an access code. This allows it to uniquely identify your Internet radio from the many others that it also provides data for. To obtain the access code, please follow these steps.
2. With your soundbar switched on and in Internet Radio mode, press and hold the **Menu** button, then select 'Station list' using the **Menu Up or Down** and the **Select** buttons.
3. Scroll down the Station List menu to the item called 'Help'. Press and release the **Select** button to enter the Help menu.
4. In the Help menu, select the menu item 'Get access code'. Provided that the soundbar is connected to the Internet, a code will be displayed of typically seven characters (upper case letters and numbers). Make a note of this code for the next step. If you need to re-register later you must repeat this process to get a fresh access code.
5. You should then use the code displayed by the soundbar to fill in the Access Code field on the web page when you set up your account.

Once you have your account set up, if you have other radios which use the same database, you may also add them to your account. You will need to get an access code from each radio in order to add it to the account. They may then share your favourite and added radio station details.

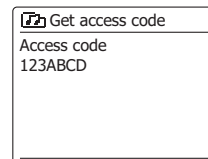
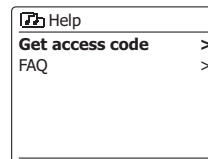
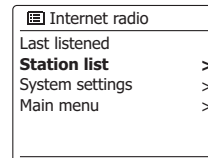

Customising your soundbar - cont.

Configuring My Favourite Stations

1. Using the web site at <http://www.wifiradio-frontier.com> it is possible to search among the many radio stations that are available by location, genre, or language. You may also choose from new or popular stations.
2. When the radio stations that you have found are shown on your computer screen, they are shown with a 'Play' icon and an 'Add to favourites' icon (the plus symbol and heart). Clicking on the 'Play' icon will allow you to hear the radio station via your computer. Clicking on the 'Add to favourites' icon will cause the radio station to be added to the list accessible via your soundbar.
3. To help you organise your favourites, and since you may have a great many after a while, the web site will allow you to specify the name for a category or group under which the radio station will be listed on your soundbar. Suitable names might be 'Rock', 'Smooth', 'Mum's stations', and so on. When ever you add another radio station to your favourites you can either add it to an existing category or create a new one.
4. Once you have Internet radio stations available in your My Favourite Stations list, you may play these stations from your soundbar. These stations will be available on your soundbar from the Internet Radio menu item 'My Favourites'.
5. To look at, modify or delete your favourite stations lists on the web site, use the link 'My favourites' in the 'My account' area. To delete a favourite radio station, click on the icon with a heart and minus symbol.

Configuring My Added Stations

1. If you wish to listen to a radio station which is not currently held in the database at <http://www.wifiradio-frontier.com> it is possible to add the details yourself. You will need to obtain the internet address (URL) for the audio stream for the station that you wish to add. This may be information provided by the radio station itself, via its web site, or perhaps passed to you from another listener.
Note: The URL for the audio stream will generally not be the URL for the web page from which you listen to the station on your PC.
2. Use the ' My added stations' link in the 'My account' area on the web site. This allows you to add details of new stations or to modify those already added. You can provide a name for the radio station which will be shown on your soundbar. You must also provide the web address, location and format details.
3. Once you have Internet radio stations available in your My Added Stations list, you may play these stations from your soundbar. These stations will be available on your soundbar from the Internet Radio menu item 'My Added Stations'.
4. It is possible to add the web addresses for audio streams which may not be playable by your soundbar. If you attempt to play such a stream, your soundbar will normally display an error message of some kind. The Sangean SB-100 can only play MP3, WMA and AAC Internet radio streams.
5. To look at, modify or delete your added stations list on the web site, use the link 'My added stations' in the 'My account' area. To delete an added radio station, click on the icon with a heart and minus symbol.

Last Listened

It is often helpful to be able to go back to a station that you have recently listened to. Your soundbar has a 'Last Listened' feature which provides you with quick access to the ten most recently listened to radio stations or podcasts. As each new radio station is listened to the oldest item is deleted from the list. The Last Listened list is stored when the soundbar is disconnected from the mains.

1. With the soundbar switched on and in Internet Radio mode, press and hold the **Menu** button.
The first item on the menu is 'Last listened'. With this item highlighted press the **Select** button.
2. The display will then show a list of the last ten Internet radio stations or podcasts. Press the **Menu Up** or **Down** buttons to highlight whichever you wish to listen to and then press the **Select** button to cause your soundbar to reconnect to that radio station or podcast.

Storing favourite stations with your soundbar

It is also possible to store your favourite radio stations whilst playing a station on your soundbar.

1. Press the **On/Standby** button to switch on your soundbar.
2. Tune to the required station using one of the methods described on the preceding pages.
3. Press and hold the **Select** button. The display will show 'Favourite added'.
4. These stations will be available on your soundbar from the Internet Radio menu item 'My Favourites', see 'Selecting your favourite stations' overleaf.

Repeat this procedure as needed to store other favourite stations.

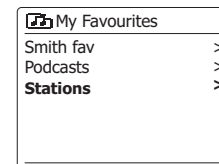
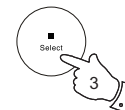
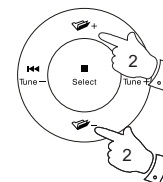
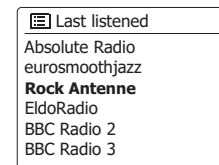
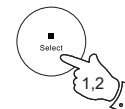
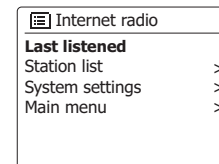
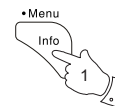

Selecting your Favourite stations or My Added stations

1. Press and hold the **Menu** button to enter the main Internet Radio menu.
2. Press the **Menu Up** or **Down** buttons until 'Station list' is highlighted on the display. Press and release the **Select** button to enter the menu.
3. Press the **Menu Up** or **Down** buttons until 'My Favourites' or 'My Added Stations' is highlighted on the display. Press and release the **Select** button and your favourite stations list or your added stations list will appear on the display.
4. Press the **Menu Up** or **Down** buttons to highlight the required station and then press and release the **Select** button to confirm your selection.

The display will show 'Connecting...' while it finds the new station.

If the station has on-demand content such as Podcasts, please see 'Selecting a Podcast'.

Should you be unable to connect to a particular station, please note that some radio stations do not broadcast 24 hours per day, and some stations are not always on-line.

In addition, as mentioned in the previous section, it is possible to specify audio streams for 'My added stations' which are not compatible with your soundbar. In this event the station will not be playable. The Sangean SB-100 can only play MP3, WMA and AAC internet radio streams.

Note that the audio coding formats listed are generic terms. There are many variations of each format, as well a variety of streaming protocols in use by different radio broadcasters. Your soundbar has been designed to play the vast majority of coding and streaming formats in current use by broadcasters.

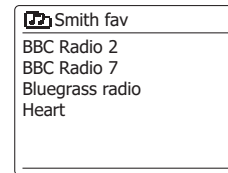
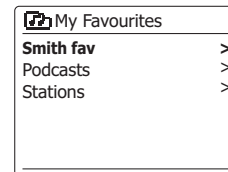
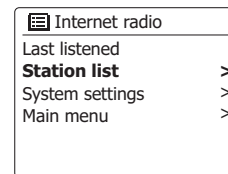
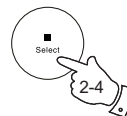
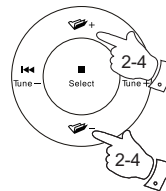
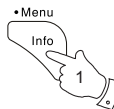

DAB Radio

Using DAB mode for the first time

1. Ensure the antenna switch is set to the internal or external antenna as required. If reception using the internal antenna is not satisfactory it may be necessary to use an external antenna to improve reception.

2. Press the **On/Standby** button to switch on the soundbar. If the soundbar has been used before the last used mode will be selected.

3. Press the **Radio** button as needed so that DAB Radio mode is selected on the display.

4. If this is the first time that DAB mode is used a scan of the Band III DAB channels will be carried out. The display will show 'Scanning'. (If the soundbar has been used before the last used station will be selected instead.)

During the scanning process, as new stations are detected the station counter will increase and the stations will be added to the list which is stored in the soundbar. The bar graph indicates the progress of the scan.

5. When scanning is completed the radio will list the stations found (in numeric- alpha order 0...9...A...Z), unless it has previously been tuned to a DAB station.

Press the **Menu Up** or **Down** buttons to scroll through the list of available DAB radio stations.

Press and release the **Select** button to select the highlighted station. The display may show 'Connecting...!' while the radio re-tunes.

Use the **Volume** buttons to set the sound level as needed.

6. If the station list is still empty after the scan the display will show 'No stations found'.

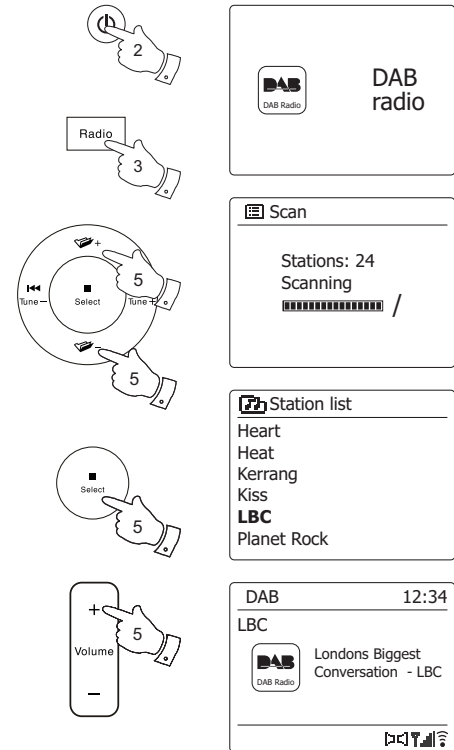

Selecting a DAB radio station

1. When playing a DAB radio station, the display normally shows the name of the current station with other related information.
2. Press the **Menu Up** or **Down** buttons to access the radio station list and to scroll through the available stations.
3. Press and release the **Select** button to select the highlighted station. The display may show 'Connecting...' while the radio re-tunes.
4. Use the **Volume** buttons to set the sound level as needed.

A question-mark in front of the station name merely indicates that the station has not recently been detected by the soundbar. It may still be available.

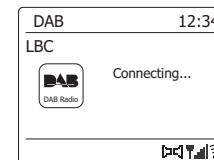
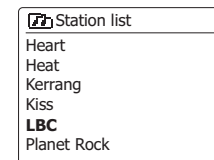
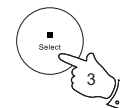
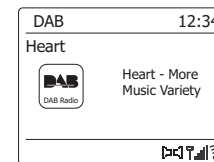
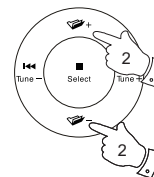

Secondary services

Some DAB radio stations can have one or more secondary stations associated with them. Typically these are not broadcast continually. If a station has a secondary station available then the secondary will appear in the list of station names beneath the main (or primary) station. Examples are the programmes 'Daily Service' and 'Parliament' on BBC Radio 4.

1. To listen to a secondary service, use the **Menu Up** or **Down** buttons to scroll to the chosen station, and press and release the **Select** button to tune to the station.

If the secondary service is not available (off-air) then the primary service will be selected.

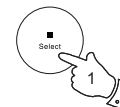
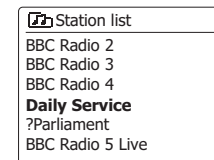
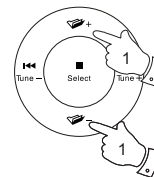

Display modes

Your soundbar has a range of display options when in DAB mode:

1. Press and release the **Info** button to cycle through the different options.

| | |
|-------------------------|---|
| Text | Displays text messages such as the artist or track name, phone in number, traffic alerts, etc. |
| Program Type | Displays the type of station being listened to such as Pop, Classic, News etc. |
| Multiplex / Frequency | Displays the name of the DAB multiplex to which the current station belongs as well as its broadcast frequency. |
| Signal error / strength | Displays the signal error and strength for the station being listened to. A lower error number indicates a better quality of radio signal. The signal strength graph can be used when positioning the radio. For good reception the graph should occupy three or more blocks. |
| Bit rate and audio type | Displays the digital bit rate and audio coding information for the station being listened to. |
| Date | Displays the current date. |
| DL Plus text | Some stations may provide other programme related information for the display in addition to the regular text. If none is available, a message 'no info' is displayed. |

A signal strength indicator is always shown in the lower area of the display on the right hand side. If the broadcast being received is in stereo, then the stereo speaker symbol will be shown. If the currently tuned station has been stored as a preset, then the preset number will also be shown.

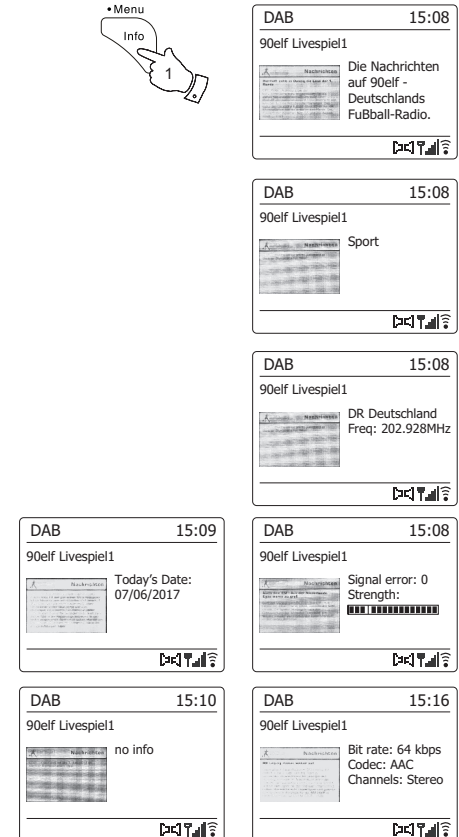
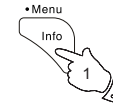

Finding new DAB radio stations

Should you wish to use your soundbar for DAB reception in a new location, or if no stations were detected during the initial scan, you can follow this procedure to allow your soundbar to find out which DAB radio stations are available.

1. Ensure the antenna switch is set to the internal or external antenna as required. If reception using the internal antenna is not satisfactory it may be necessary to use an external antenna to improve reception.
2. Press the **Radio** button as needed to select DAB Radio mode.
3. Once in DAB mode **press and hold** the **Menu** button.
4. Press the **Menu Up** or **Down** buttons until 'Scan' is highlighted on the display.
5. Press and release the **Select** button to initiate the scan. The display will show 'Scanning' and your radio will perform a scan of the Band III DAB frequencies. As new stations are found the station counter will increase and stations will be added to the list. The bar graph indicates the progress of the scan.
6. Alternatively press the **Auto Tune** button on the remote control to initiate a scan of the DAB Band III frequencies.

The Auto Tune button may not operate in all display modes. In this case use the menu option above.

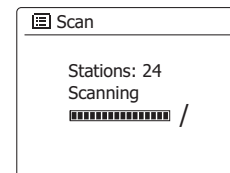
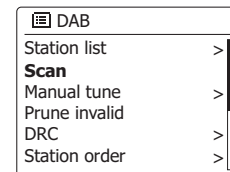
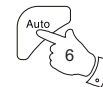
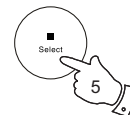
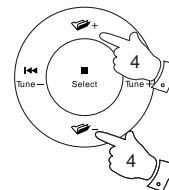
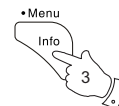
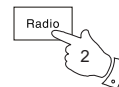

Manual Tuning

Manual tuning allows you to tune directly to the various Band III DAB channels (5A to 13F).

1. When in DAB mode press and hold the **Menu** button so that the display shows the DAB menu.
2. Press the **Menu Up** or **Down** buttons until 'Manual tune' is highlighted.
3. Press and release the **Select** button to enter manual tune mode.
4. Press the **Menu Up** or **Down** buttons to choose the required DAB channel.
5. Press and release the **Select** button to cause the radio to tune to the chosen channel.

When the radio has tuned, the display shows the channel number and frequency, and the name of the DAB multiplex found (if any).

A bar graph shows the signal strength and is useful if you need to reposition the soundbar. The minimum signal marker 'I' which separates the left and right parts of the signal graph shows the minimum signal level required for satisfactory reception.

Any new radio stations found on the tuned DAB multiplex will be added to the list stored in the soundbar.

6. Press the **Back** button to choose a different frequency.
7. Press the **Back** button a second time to access the main DAB menu then select 'Station list' to return to normal tuning.

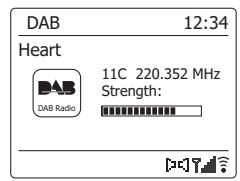
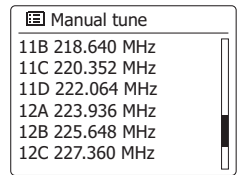
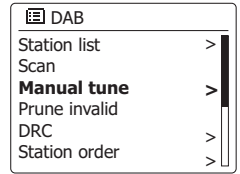
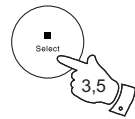
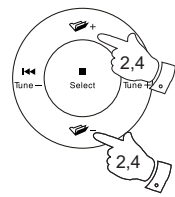
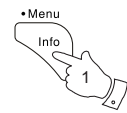

Dynamic Range Control settings

Dynamic Range Control (also known as DRC) can make quieter sounds easier to hear when your soundbar is used in a noisy environment by reducing the dynamic range of the audio signal.

1. Press the **On/Standby** button to switch on your soundbar.
2. Press the **Radio** button as needed to select DAB Radio mode.
3. Press and hold the **Menu** button to enter the DAB menu.
4. Press the **Menu Up** or **Down** buttons until 'DRC' is highlighted on the display.
5. Press and release the **Select** button to enter the DRC adjustment mode. The current DRC setting will be indicated with an asterisk.
6. Press the **Menu Up** or **Down** buttons to highlight the required DRC setting (the default is Off).
'DRC Off' - DRC is switched off, Broadcast DRC will be ignored.
'DRC high' - DRC is set as sent by broadcaster.
'DRC low' - DRC level is set to 1/2 that sent by broadcaster.
7. Press and release the **Select** button to confirm the setting.

Note: Not all DAB broadcasts use the DRC function. If the broadcast does not provide DRC information, then the DRC setting in the soundbar will have no effect.

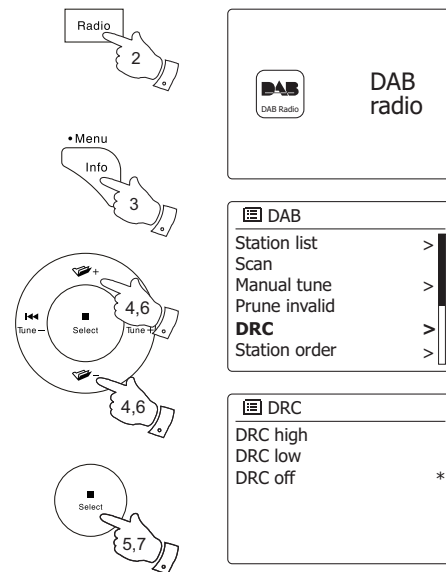

Station order setup

Your soundbar has 3 station order settings from which you can choose. The station order settings are, alphanumeric, ensemble and valid.

Note: The default station order on your soundbar is alphanumeric.

1. Press the **On/Standby** button to switch on your soundbar.
2. Press the **Radio** button as needed to select DAB Radio mode.
3. Press and hold the **Menu** button to enter the DAB menu list.
4. Press the **Menu Up** or **Down** buttons until 'Station order' is highlighted. Press the **Select** button to enter the station order adjustment mode.
5. Press the **Menu Up** or **Down** buttons to choose between 'Alphanumeric', 'Ensemble' and 'Valid'.
 'Alphanumeric' - sorts the station list alpha-numerically 0...9 A...Z.
 'Ensemble' - organizes the station list by DAB multiplex.
 'Valid' - shows only those stations for which a signal can be found. The current setting is indicated by an asterisk.
6. Press and release the **Select** button to select the required station order.
7. Press the **Back** button as needed to return to the DAB menu or to the stations list.

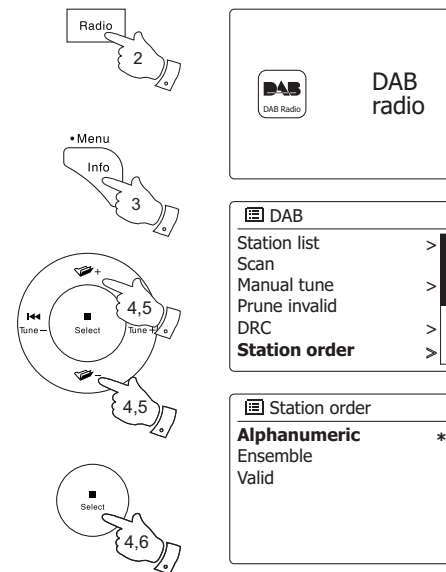

Prune stations

If you move to a different part of the country, some of the stations which were listed may no longer be available. Also, from time to time, some DAB services may stop broadcasting, or may change location or frequency. Stations which cannot be found, or which have not been received for a very long time are shown in the station list with a question mark.

The Prune stations function will delete the marked DAB stations from your station list.

1. Press the **On/Standby** button to switch on your soundbar.
2. Press the **Radio** button as needed to select DAB Radio mode.
3. Press and hold the **Menu** button to enter the DAB menu.
4. Press the **Menu Up** or **Down** buttons until 'Prune invalid' is highlighted. Press and release the **Select** button.
5. To cause the stations list to be pruned, eliminating unavailable stations press the **Menu Left** or **Right** buttons until 'YES' is highlighted on the display.
6. Press and release the **Select** button to cause the invalid station names to be removed from the station list.

If you do not wish to prune stations, highlight 'NO' and then press and release the **Select** button. The display will revert to the previous menu.

Note:

If you have moved your soundbar to a different part of the country you should also carry out a search for new stations (please see the section 'Finding new stations').

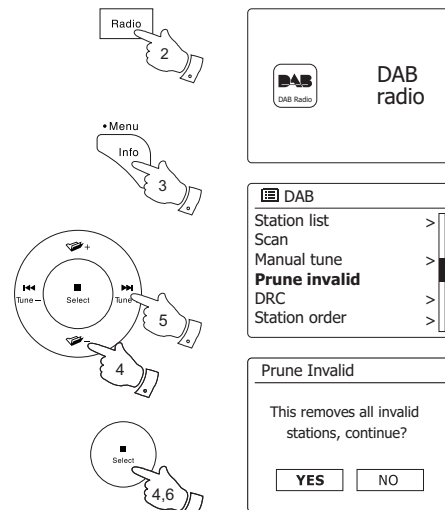

FM Radio

Operating your radio in FM mode

1. Ensure the antenna switch is set to the internal or external antenna as required. If reception using the internal antenna is not satisfactory it may be necessary to use an external antenna to improve reception. You may also need to change the FM scan setting. Press the **On/Standby** button to switch on your soundbar.
2. Press the **Radio** button as needed to select FM radio mode.
3. Press and hold the **Menu Left** or **Right** buttons to scan the FM band.
4. The display will show the frequency of the signal which has been found. If RDS information is available, after a few seconds the display will show the radio station name.
5. To find more FM stations repeat the scan operation. Your soundbar will scan the FM band from the currently displayed frequency and will stop scanning when it finds a signal of sufficient strength.
6. Alternatively the **Auto Tune** button (on the remote control) can also be used.
If you only hear hiss or interference, simply press the **Auto Tune** button to scan further. Your soundbar may have found a spurious interference signal.
7. When the end of the waveband is reached your radio will recommence tuning from the opposite end of the waveband. Use the **Volume** buttons to adjust the sound level as needed.

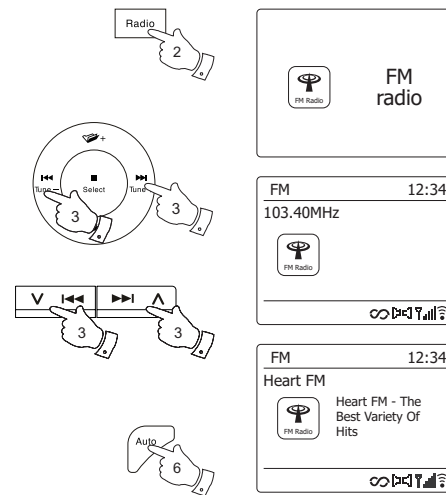

Manual tuning

1. Ensure the antenna switch is set to the internal or external antenna as required. If reception using the internal antenna is not satisfactory it may be necessary to use an external antenna to improve reception.
2. Press the **On/Standby** button to switch on your soundbar.
3. Press the **Radio** button as needed to select FM Radio mode.
4. Press and release the **Menu Left** or **Right** buttons to control the frequency that the soundbar will tune to. The frequency will change in steps of 50kHz.
When the end of the waveband is reached the radio will recommence tuning from the opposite end of the waveband.
5. Use the **Volume** buttons to adjust the sound level as needed.

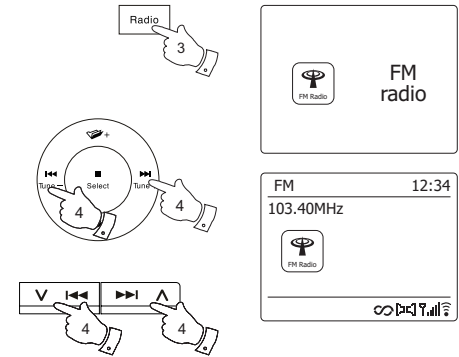

Display modes

Your soundbar has a range of display options when in FM mode:

1. Press and release the **Info** button to cycle through the different options.

- Text Displays text messages such as the artist or track name, phone in number, traffic alerts, etc.
- Program Type Displays the type of station being listened to such as Pop, Classic, News etc.
- Frequency Displays the frequency of the FM signal.
- Date Displays the current date.

Note: If no RDS information is available, then the soundbar will only be able to display the frequency. There will be no text or programme type information available under these conditions. The soundbar only provides displays when there is information available. So if there is no text, for example, that display is not available.

The RDS indicator at the bottom of the display shows that there is some RDS data present in the broadcast being received.

The stereo speaker display shows that the soundbar is receiving a stereo broadcast (please see also 'Stereo/Mono switching').

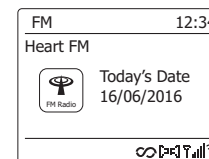
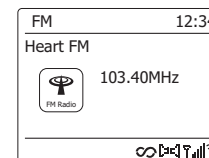
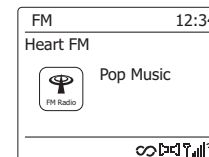
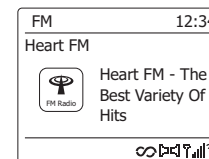
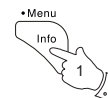

Scan setting

When using the FM mode your soundbar can be set to either scan local stations or to scan all stations including distant radio stations.

1. Press the **Radio** button as needed to select FM Radio mode.
2. Press and hold the **Menu** button to enter the FM menu.
3. Press the **Menu Up** or **Down** buttons until 'Scan setting' is highlighted and then press and release the **Select** button to enter the scan adjustment mode.

The current scan setting is indicated with an asterisk.

4. To set your soundbar so that only the stations with the strongest signals are found during scanning press the **Menu Left** or **Right** buttons until 'YES' is highlighted. Press and release the **Select** button to confirm the setting. (Normally this will restrict scanning to local transmissions.)

Alternatively, to set your soundbar so that all available stations are found during scanning (local and distant transmissions) press the **Menu Left** or **Right** buttons until 'NO' is highlighted.

Press and release the **Select** button to confirm the setting.

5. Press the **Back** button to return to the normal FM mode display.

Note: Your soundbar has a built-in antenna for DAB and FM radio reception. However, if there is interference from your TV or other nearby devices, the use of an external aerial will often improve radio reception. The antenna switch should be used to select the internal antenna or to use the external connection as needed. The FM scan setting may then need to be changed as described above depending on the strength of the FM radio signal.

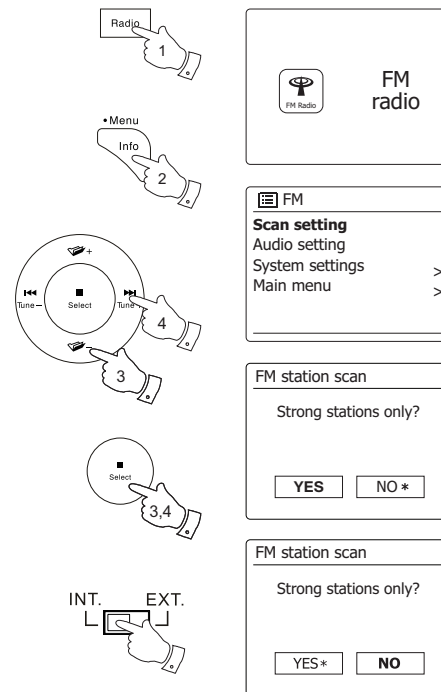

Stereo / Mono switching

If the FM radio station being listened to has a weak signal, some hiss may be audible. It is possible to reduce this hiss by forcing the soundbar to play the station in mono rather than stereo.

1. Press the **Radio** button as needed to select the FM Radio mode display and tune to the required FM station as previously described.
2. Press and hold the **Menu** button to enter the FM menu.
3. Press the **Menu Up** or **Down** buttons until 'Audio setting' is highlighted on the display. Press and release the **Select** button to enter the audio setting mode.
The current setting is indicated with an asterisk.
4. To switch to mono in order to reduce the hiss from a weak FM signal press the **Menu Left** or **Right** buttons until 'YES' is highlighted. Press and release the **Select** button to confirm the setting.
Alternatively, to return to the normal automatic 'stereo or mono' mode press the **Menu Left** or **Right** buttons until 'NO' is highlighted. Press and release the **Select** button to confirm the setting.
5. Press the **Back** button to return to the normal FM mode display.

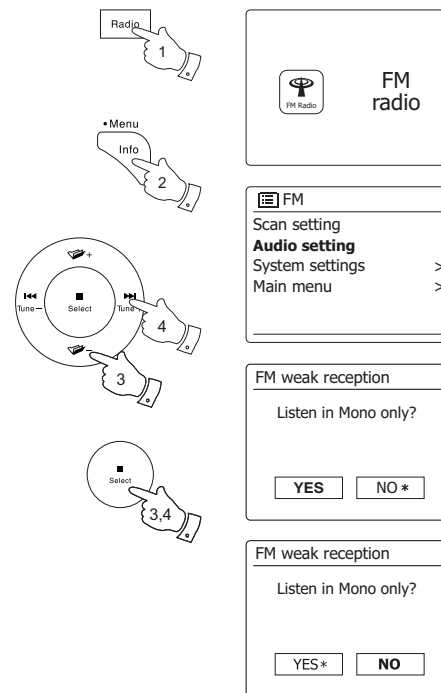

Presetting stations

Your soundbar has ten memory presets each for DAB and FM radio. They are used in the same way for each operating mode.

The radio station presets are retained even when the soundbar is switched off.

Storing a preset 1-10 using the remote control

1. Press the **On/Standby** button to switch on your soundbar.
2. Tune to the required station using one of the methods described on the preceding pages.
3. To store the currently playing radio station as a preset, **press and hold** the required **Preset** button (1 - 10) on the remote control until the display shows 'Preset stored'. The station will be stored using the chosen preset button. Repeat this procedure as needed for the remaining presets.
4. Stations that are already stored in the presets may be over-written by following the procedure described above.

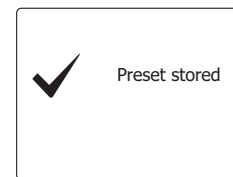
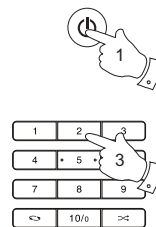

Recalling a preset 1-10 using the remote control

1. Press the **On/Standby** button to switch on your soundbar. Select the DAB or FM Radio mode using the **Radio** button.
2. Momentarily press the required **Preset** button on the remote control. Your soundbar will then connect to the station stored in the preset memory. The preset used will be shown at the bottom of the display screen.

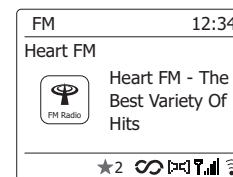
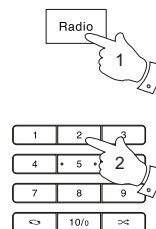

Storing a preset using the unit

1. Press the **On/Standby** button to switch on your soundbar. Tune to the required station using one of the methods described on the preceding pages.
2. **Press and hold** the **Preset** button. The display will show a 'Save to Preset' menu.
3. Press the **Menu Up** or **Down** buttons to scroll through the preset list until you reach an unused preset or a preset that you wish to change. Press and release the **Select** button to store the preset. 'Preset stored' will be shown on the display. Repeat this procedure as needed for the remaining presets.
4. Stations which are already stored in the presets may be over-written by following the procedure above.

Recalling a preset using the unit

1. Select the DAB or FM radio mode using the **Radio** button.
2. Press and release the **Preset** button to display the 'Recall from Preset' menu.
3. Press the **Menu Up** or **Down** buttons to select the desired preset station. Press and release the **Select** button.

Your radio will then connect to the station stored in the preset memory. The preset used will be shown at the bottom of the display screen.

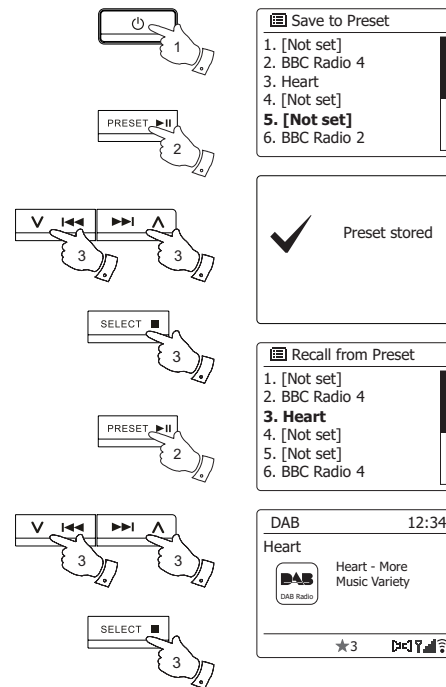

Music Player

Use with Windows, Apple Mac, Linux

The Music Player allows you to play audio files which are stored on a another device connected to your network.

Networked devices that could hold audio files can include computers, smart phones, tablets, Network Attached Storage (NAS) units, and network routers which have UPnP / DLNA file sharing capability. In order to play files from a device on your network, your soundbar must connect to a file server program on that device which uses the Universal Plug and Play (UPnP) protocol (often known as DLNA).

If the device is a computer or tablet using Windows, then it probably already has a UPnP server program available in the form of Windows Media Player (WMP). This allows you to share your files to devices on your network, and you may then select files by Album, Artist, and so on using your soundbar's controls. WMP can serve MP3, WMA, AAC and WAV files to your soundbar (and FLAC files from Windows 10).

If you are an Apple MacOS, Linux, iOS or Android user, or if you have your audio files stored in other formats, such as ALAC, there are many other UPnP server programs available. Note that Apple computers do not support UPnP streaming natively and third party software is required for this task. If you wish to use a DLNA server built into your NAS or network router, you should consult your manufacturer's documentation on how this should be configured.

The Music Player on the soundbar can play audio files in MP3, WMA, AAC, ALAC, FLAC and WAV formats. WMA Lossless files can also be played when using Windows Media Player as the UPnP server. Note that the playback of files encoded using WMA Voice, WMA 10 Professional, and of files which have DRM protection is not supported by the soundbar.

Please note that when using a UPnP/ DLNA server, the search and selection criteria that are available to the user are determined by the server software, and not by the device playing the content. Typical searches include Artist, Album and Genre. Many server applications also allow you to access your files according to the folders within which they are stored as well as other criteria. Windows Media Player is less flexible than some other UPnP servers in this regard, but is generally easier to set up.

Many UPnP server applications are also capable of sharing pictures and video files to other network connected devices. If this is the case (as it is with Windows Media Player) you may see the option of choosing between 'Music', 'Video' and 'Pictures' on the Music Player's menu. Clearly you should only select the 'Music' option. Content offered via the alternative options will not be playable on your soundbar.

Some third party server applications allow customization of the search criteria and indexing methods. This can be useful if you have a very large collection of stored music files.

It is not possible in this book to describe server applications for all available environments, and neither is it practical to describe how to get the best out of each. Windows Media Player is used as an example in this case, although many of the principles are applicable to other servers as well. The access to the media, the choice of media for playing, and the use of the media playback controls from the product or from its controlling app are similar regardless of the UPnP / DLNA server being used.

When using your soundbar as part of a group of multi-room products, audio files in ALAC and FLAC formats will only play on the group master.

Accessing your audio files via a UPnP server

If your computer is running Windows 7, 8, or 10, then Windows Media Player includes a UPnP server which will make your files available to your soundbar. There are other UPnP server solutions available for non- Windows users and for Windows users who may wish to use an alternative (see the preceding page).

It is beyond the scope of this instruction book to cover all possible options for UPnP. We explain the use of Microsoft's Windows Media Player here since that will be the first choice for the majority of users.

Set up UPnP access with Windows Media Player

1. At the time of writing, Windows 7, 8, and 10 all use Windows Media Player version 12 (referred to here as WMP 12), and the configuration is similar in each case. WMP 12 can create a library from all the media files available to it on your PC. To add new media files to the library, select 'Library', then 'Music', then 'All music' or 'Artist', 'Album' etc. This will show you the current library contents. You may then simply drag and drop files from other locations into the library. Alternatively, with media files or folders on the screen, you may right-click on the file or folder and select 'Include in library' and then select 'Music'. In this way you can quickly add additional content to your music library.
2. In WMP 12, click on 'Stream' (see picture at right) and then select 'Automatically allow devices to play my media'. Then accept the 'Automatically allow all computer and media devices' option. There are other options (see overleaf) but this is the simplest if you just wish to quickly enable media streaming to your soundbar.
3. Press and release the **On/Standby** button to switch the soundbar on. Then press the **Media** button as needed until the Music Player mode display is shown. The main 'Music Player' menu will then be displayed.

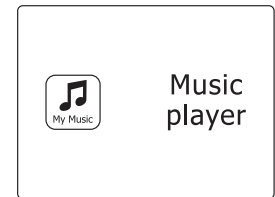
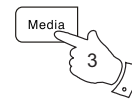
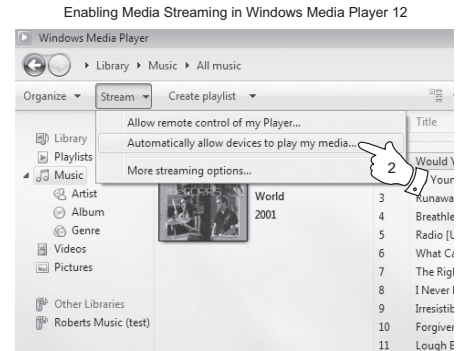

Set up UPnP access on a Windows PC - cont.

4. Press the **Menu Up** or **Down** buttons until 'Shared media' is highlighted and press the **Select** button to select. The soundbar will scan for all available UPnP servers. It may take a few seconds for the soundbar to complete its scan. The soundbar will display '<Empty>' if no UPnP servers are found.

5. After scanning, select your UPnP server using the **Menu Up** or **Down** and **Select** buttons. If you allowed automatic connection previously, your soundbar should now connect and you may skip to the next page.

If you did not permit automatic connections, your soundbar will then normally display 'Unauthorised' at this stage.

6. Your PC may prompt you that there has been a connection to your UPnP server. Whether prompted or not, in order that the soundbar may access the music files, you will need to click the 'Library' tab in WMP 12 and select the 'Stream...' item to open the 'Media Streaming' window. Select 'Automatically allow devices to play my media' then select 'Automatically allow all computer and media devices'.

Alternatively select 'More Streaming options' to enable sharing on a 'per device' basis.

7. In the 'More streaming options' window, the soundbar may be listed as a blocked device. Click on the button shown to select 'Allowed'.

Note: If you are using Microsoft's Windows' firewall software, this should be correctly configured by WMP 12. If you are using third party firewall software you may need to manually configure it to allow your unit and WMP 12 to communicate.

8. On the soundbar, select the named server again using the **Menu Up** or **Down** and **Select** buttons. If WMP 12 is now able to communicate with your soundbar you will be presented with some media selection options on the display.

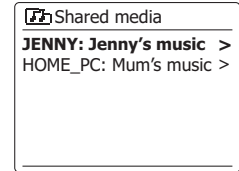
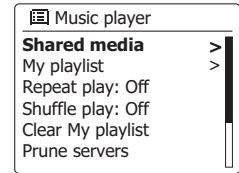
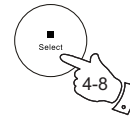
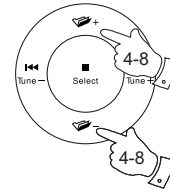

Allowing a device to connect to Windows Media Player 12

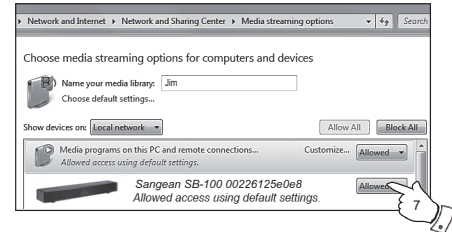

Locating and playing media files using UPnP

Once the UPnP server has been configured to share media files with your soundbar, you may select the files that you wish to play as follows:

1. Press the **On/Standby** button to switch on the unit. Press the **Media** button as needed until Music Player the mode display is shown. The main Music Player menu will then be displayed.
2. Press the **Menu Up** or **Down** buttons until 'Shared media' is highlighted on the display and then press the **Select** button to cause the soundbar to scan for UPnP servers. Note that it may take a few seconds for the soundbar to complete its scan. The display will return to the Music Player menu if no UPnP servers are found.
3. After a successful scan, press the **Menu Up** or **Down** buttons to highlight your UPnP server and then press the **Select** button. If the display shows multiple media types, select 'Music'. (Some UPnP servers can serve pictures and video content to suitable devices.)
4. The soundbar will now list the media categories which are made available by the UPnP server - for example, 'Album', 'Artist' and 'Genre'. Press the **Menu Up** or **Down** buttons to highlight which category you wish to browse, then press the **Select** button to confirm your choice.
If you wish to use the search function, press the **Menu Up** or **Down** buttons until 'Search' is selected on the display. You may select characters to build a keyword for searching for content to play.

When you first set up sharing with a UPnP server, not all of your files will be available immediately. The UPnP server must look inside each file to identify the artist and album information from 'tags' embedded in them. The server may also need time to access the Internet to obtain additional information such as 'album art' which it can display when you examine your music library on your PC. For a library of many files this can take some time.

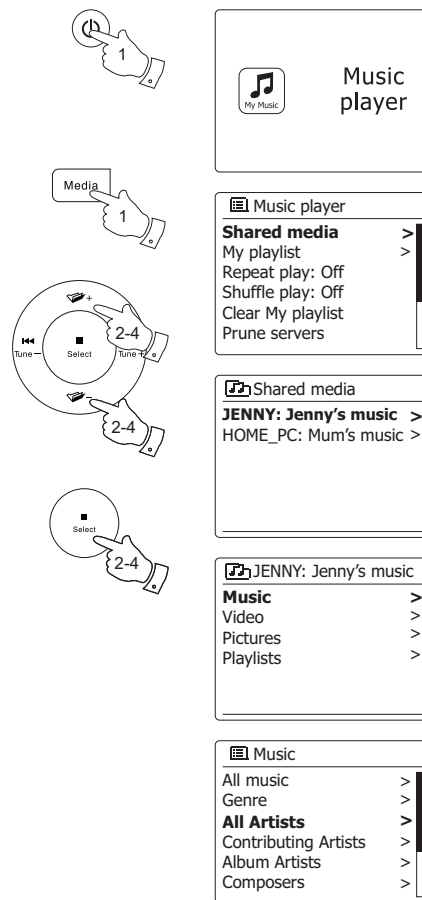

Media selection

When searching via UPnP you will have a selection of search criteria as determined by the UPnP server software on your computer. This allows you to search by a given information type (Album, Artist, Genre, etc.) and then to narrow the search to an album or to a particular track within an album. Some UPnP server applications allow the search options to be customized. The searches described here are just examples of the possibilities.

Listening to a complete album

1. Press the **Menu Up** or **Down** buttons to choose content by Artist, Album, Genre, etc. according to your needs then press the **Select** button to enter your choice.
2. When you reach the album or folder the menu will then switch to showing the tracks in that album or folder. When searching by UPnP they will normally be listed in track number order (but as with the search criteria, this can vary according to the server application used).
3. With the first track in the album indicated, press the **Select** button. The album will then begin playing.

While the soundbar is playing from your media library, you may use the menus as described above to choose a different selection. When you select the track from which to play, the soundbar will then immediately begin playing the new selection.

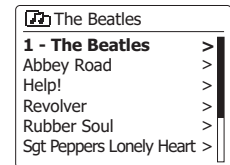
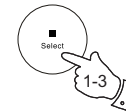
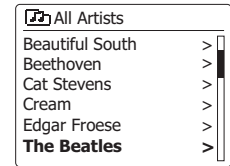
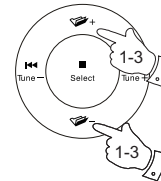
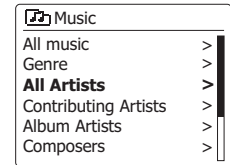
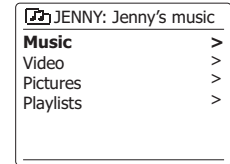

Listening to a particular track

1. If you wish to play only a particular track from an album or folder, first choose the album or folder as described on the preceding pages.
2. Press the **Menu Up** or **Down** buttons until the required track is highlighted.
3. Press and release the **Select** button. The track will begin playing. The soundbar will then play subsequent tracks from the same album or folder.

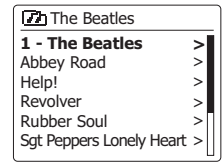
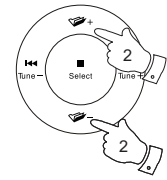

Controlling playback

1. Press the **Play/Pause** button to pause playback of the current track.
2. If you press the **Play/Pause** button, playback will resume from the point where it was paused.
3. Press the **Previous** button to start playback of the previous track in the list.
4. Press the **Next** button to start playback of the next track in the list.
5. Press and hold the **Next** or **Previous** button to move through the current track. The longer the button is pressed, the greater the speed at which the player will move through the track. Release the button when the desired point is reached. (Note that this feature is not supported when playing files encoded using the FLAC and ALAC format.)
6. Press the **Stop** button to stop playback.

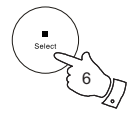
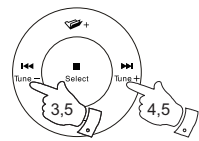
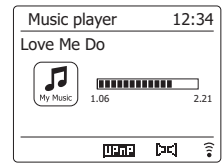
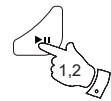
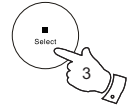

Controlling playback cont.

In the music player you may choose to repeat the current album (or playlist), or to play the files in random order, or both options together.

Repeat tracks

1. To enable or disable the Repeat option, press and release the **Repeat** button on the remote control. The **Repeat** icon will show on the display when Repeat is enabled.

You may also control the option from the Main Music Player menu.

2. Use the **Menu** button to enter the main music player menu.
3. Press the **Menu Up** or **Down** buttons until 'Repeat play' is highlighted.
To activate the repeat option press and release the **Select** button so that 'On' appears on the display. Your selected tracks will now be played repeatedly.
4. To turn off the repeat option highlight 'Repeat play' and press and release the **Select** button so that 'Off' appears on the display.
5. Press the **Back** button to exit from the menu.

Play tracks in random order

1. To enable or disable the Shuffle option, press and release the **Random** button on the remote control. The **Shuffle** icon will show on the display when Shuffle is enabled.

You may also control the option from the Main Music Player menu.

2. Press the **Menu Up** or **Down** buttons until 'Shuffle play' is highlighted.
3. To activate the shuffle option press and release the **Select** button so that 'On' appears on the display. Your selected tracks will be played in random order.
4. To turn off the shuffle option highlight 'Shuffle play' and press and release the **Select** button so that 'Off' appears on the display.
5. Press the Back button to exit from the menu.

If both Repeat and Shuffle playback options are set to 'On' then both Repeat and Shuffle icons will be shown in the display.

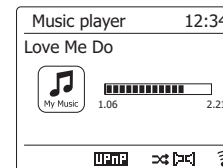
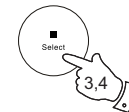
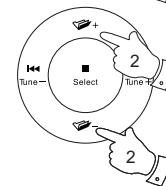
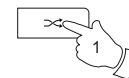
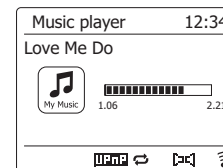
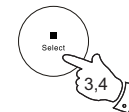
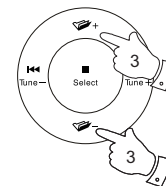
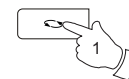

Display modes

Your soundbar has a range of display options when in Music Player mode. Note that the availability of information depends on the specific media files, their format and upon the server capability. (Not all UPnP servers make information from the media files available in the same way.)

1. Press and release the **Info** button to cycle through the different options.

- a. Progress bar Displays the playback progress for the track currently playing.
- b. Artist Displays the artist information for the track currently playing.
- c. Album Displays the album information for the track currently playing.
- d. Format Displays the bit rate and format of the track currently playing.
- e. Buffer Displays the soundbars internal buffer status during media playback.
- f . Date Displays the current date.

Whenever the Music Player is displaying an information screen (as opposed to a menu screen), the time is displayed in the top-right corner of the display, and a WiFi strength or Ethernet connection indicator is shown in the bottom-right corner together with an indicator showing the method by which the soundbar is obtaining the media - from a UPnP server.

The SB-100 is able to display the album art for the track being played. The ability of the soundbar to display art depends on the presence of the art in the file being played, the art being not too large (or being resized by the server), and the ability of the UPnP server to send the art to the soundbar. Art sent to the soundbar needs to be in a JPEG format and no larger than 640 x 480 pixels. If the soundbar does not receive any art then a default icon is displayed. Some UPnP server applications will also send a default icon if no art is found within the file being played. Some UPnP server applications will be able to re-size the art, if needed, before sending it to the soundbar. If the soundbar expects to receive art but none is provided then no art or icon will be displayed. Due to the wide variations in album art formats and UPnP/DLNA standards, the failure of the soundbar to display album art is not considered to be a fault.

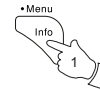

The screenshots show the following information:

- a. Progress bar:** Shows a progress bar from 1:06 to 2:21.
- b. Artist:** Shows 'Artist: The Beatles'.
- c. Album:** Shows 'Album: 1 - The Beatles'.
- d. Format:** Shows 'Bit rate: 192 kbps', 'Codec: WMA', and 'Sampling Rate: 44.1 kHz'.
- e. Buffer:** Shows a 'Playback buffer' progress bar.
- f. Date:** Shows 'Today's Date: 11/07/2016'.



Playlists

Sometimes you may wish to set up a list of music tracks or albums which can then be played without further action - as background music for a party, for example.

Your soundbar can be configured to hold a queue of up to 500 tracks in a playlist menu. The tracks or albums for the playlist can be selected from your UPnP server. The playlist is held in the memory in your soundbar until the external power is removed, or until the playlist is cleared from the menu.

Adding a single track to your playlist

1. When selecting a track using a UPnP server press and hold the **Select** button and the display will show 'Added to My playlist'.
2. The track will be added to the playlist for playback later.

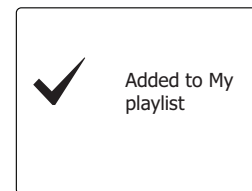
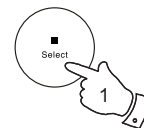

Adding an entire album or folder

3. When using a UPnP server highlight the chosen album, artist or folder and press and hold the **Select** button. The display will show 'Added to My playlist'.
4. Each of the tracks within the album, artist or folder selection will be added to the playlist individually. This allows any unwanted tracks to be removed from the playlist if needed.

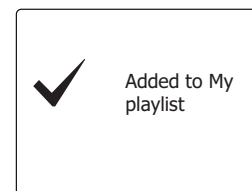
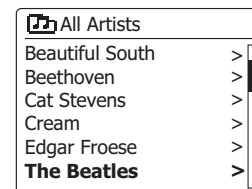
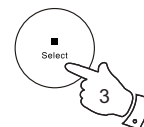

Viewing your playlist

1. Press the **On/Standby** button to switch on the unit. Press the **Media** button as needed until the Music Player mode display is shown. The Music Player menu will then be shown on the display.
2. Press the **Menu Up** or **Down** buttons until 'My Playlist' is highlighted on the display. Press and release the **Select** button to enter the playlist.
3. Press the **Menu Up** or **Down** buttons to scroll through the playlist. Tracks which are served via UPnP will show their track name.

Erasing a track from the playlist

1. **Press and hold** the **Menu** button to enter the main Music Player menu.
2. Press the **Menu Up** or **Down** buttons until 'My Playlist' is highlighted on the display. Press and release the **Select** button to enter the playlist.
3. Press the **Menu Up** or **Down** buttons until the track you wish to erase is highlighted. **Press and hold** the **Select** button.
4. You will be asked to confirm the deletion. To delete the track press the **Menu Left** or **Right** buttons until 'YES' is highlighted on the display then press and release the **Select** button to confirm the deletion.
5. If you do not wish to delete the track from the list, press the **Menu Left** or **Right** buttons to highlight 'NO' and press and release the **Select** button to cancel the operation.

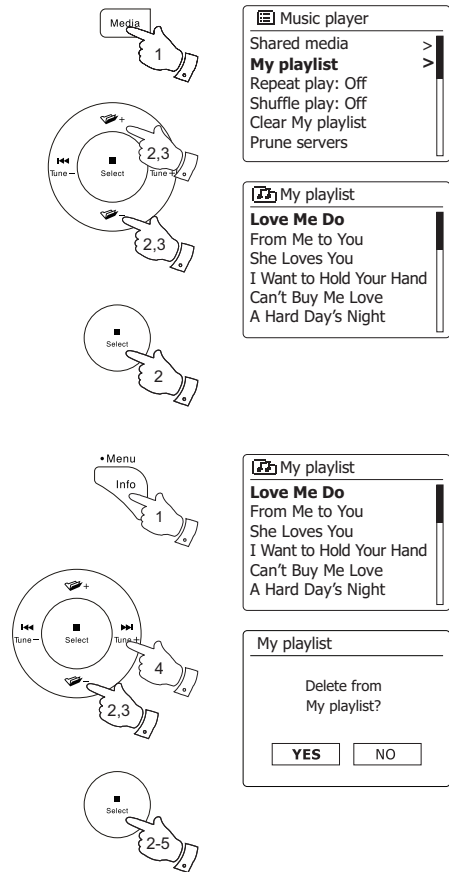

Clearing the playlist

1. Press and hold the **Menu** button to enter the main Music Player menu.
2. To clear the whole playlist press the **Menu Up** or **Down** buttons until 'Clear My playlist' is highlighted on the display. Press and release the **Select** button.
3. To clear the whole playlist press the **Menu Left** or **Right** buttons until 'YES' is highlighted on the display. Press and release the **Select** button to clear the playlist.
4. If you do not wish to clear the playlist press the **Menu Left** or **Right** buttons to highlight 'NO' and press and release the **Select** button to confirm.

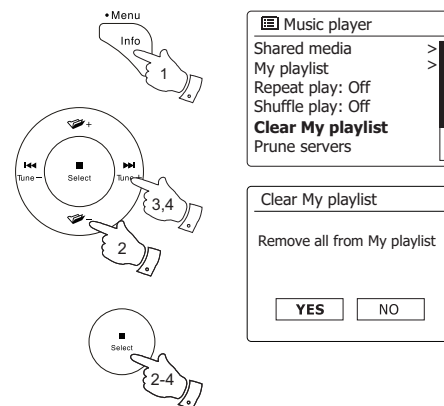

Playing your playlists

1. Press and hold the **Menu** button to enter the main Music Player menu.
2. Press the **Menu Up** or **Down** buttons until 'My playlist' is highlighted on the display. Press and release the **Select** button.
3. To play the playlist from a particular track, press the **Menu Up** or **Down** buttons until the desired track is highlighted then press and release the **Select** button to start play.
4. While playing from the playlist, you can use this function to jump to a particular track within the playlist.
5. While playing from the playlist, you may add additional tracks or albums or remove specific tracks.

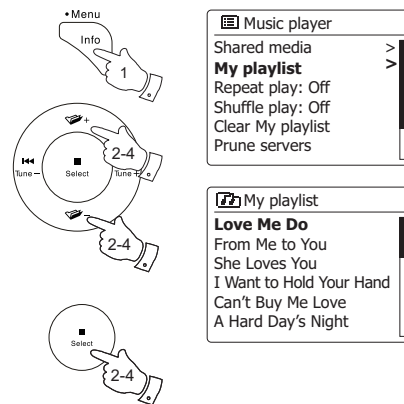

Prune servers

Your soundbar stores details of UPnP servers that it has seen via its network connection in its internal memory. If you use the soundbar at different locations you may find that there are servers listed by the soundbar that you are no longer interested in. The prune servers functions allows the list to be updated so that only active UPnP servers on the currently connected network are shown when selecting 'Shared Media' from the Music Player menu.

1. Press and hold the **Menu** button to enter the main Music Player menu.
2. Press the **Menu Up** or **Down** buttons until 'Prune servers' is highlighted on the display. Press and release the **Select** button.
3. To remove servers that are no longer required press the **Menu Left** or **Right** buttons until 'YES' is highlighted on the display. Press and release the **Select** button to cause the servers to be removed.
4. If you do not wish to prune servers press the **Menu Left** or **Right** buttons to highlight 'NO' and press and release the **Select** button to confirm.

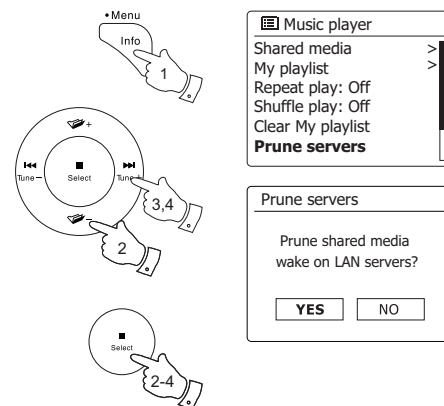

Windows 'Play to' / 'Cast to Device' function

If you use Windows 7, 8, 8.1 or 10 it is possible to choose a music album, track or playlist at the computer and then tell Windows that this should be played on the soundbar using the 'Play to' function (called 'Cast to Device' in Windows 10).

Similar functionality is available for other computer types and for handheld devices using Apple's iOS or Android operating systems. In this mode the soundbar operates as a Digital Media Renderer (known as DMR mode).

1. Ensure your soundbar is plugged in and connected to your network.
2. At your windows PC, locate the file, album or playlist that you wish to play on the soundbar.
3. Use the right-hand mouse button to pop-up a menu of options for the chosen item and select the 'Play to' / 'Cast to Device' option.
4. Windows should show you one or more devices, including your soundbar, to which you may choose to send the music. Highlight the soundbar item and click with the left mouse button.
5. Windows will then open a 'Play to' / 'Cast to Device' window showing the track or tracks to be played. Your computer will then take control of your soundbar. Your soundbar will enter the Digital Media Renderer mode (DMR) and after a few seconds the soundbar will start playing. The display on the soundbar will show that is it in DMR mode.
6. While the soundbar is playing in DMR mode you can use the controls in the 'Play to' / 'Cast to Device' window on your computer to skip tracks, fast-forward or rewind, to pause or restart, and to change the volume on the soundbar.

You may also use the controls on your soundbar to adjust volume, display track information (press the **Info** button) or to change operating mode. It is not possible to skip tracks or pause playback using the soundbar's controls while it is in DMR mode.

7. While playing, you may select additional content within Windows and again use the 'Play to' / 'Cast to Device' function (see steps 2 – 4). The additional tracks will be added to the playlist in the current 'Play to' / 'Cast to Device' window. You may also delete or change the order of tracks within the 'Play to' / 'Cast to Device' window.
8. When you wish to exit DMR mode, simply either switch off your soundbar or select a different operating mode.

Note: Some Windows security software can prevent correct operation of the 'Play to' / 'Cast to Device' function. Such software may have updates or configuration options which will permit 'Play to' / 'Cast to Device' to operate correctly - please consult your anti-virus software supplier. The 'Play to' / 'Cast to Device' function in Windows 7, 8 and 10 has been tested successfully with the SB-100 when using Microsoft's own security software without problems.

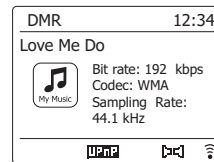
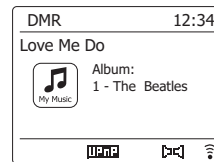
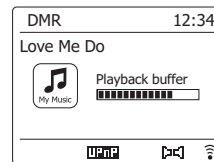

Listening to Spotify

Playing music using Spotify Connect

Introduce your SB-100 Soundbar to a whole new world of music. With Spotify, you can enjoy instant access to millions of songs. A Spotify Premium subscription is required.

For details, see the Spotify homepage.

<http://www.spotify.com>

The Spotify software is subject to third party licenses found here:

www.spotify.com/connect/third-party-licenses

1. Prepare for playback

- Download Spotify app ( Spotify) to your smartphone or tablet and log in to the app.
- Check the network environment and then turn on this Soundbar's power (please refer to 'Configuration' in the previous section.)

Note:

It is necessary that your Soundbar and your smartphone or tablet connect to the same wifi network, so that you can find the Soundbar on your smartphone or tablet later.

2. Open Spotify on your smartphone (for example), then enter the Playback screen as shown in the right side.



Note:

On some devices the layout of controls within the Spotify app may be different from that shown and may also change with different versions of the app. Refer to [spotify.com/connect](https://www.spotify.com/connect) if needed.

3. Press the **Radio** button on the remote control to select the Spotify Connect mode. (Or press and release the **Mode** button on the soundbar and then use the **Menu Up** or **Down** and **Select** buttons to select the Spotify Connect mode.) The message 'Waiting for Users' is displayed.

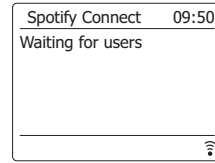

4. Play tracks via your Soundbar.

Press the Connect icon (🔗) at the bottom of the screen on your smartphone and you should find your soundbar on the list. Press the item and your smartphone is linked with your soundbar (e.g. Sangean SmartBar). You can see the green Connect icon indicating the connect is on soundbar. Now you can listen to audio streamed wirelessly from your linked smartphone.

Note:

If you cannot see the icon, it indicates no connect device available. Check your device's user manual or the manufacture's support site as a firmware upgrade may be required.

5. Control playback.

Use the controls on your Connect-enabled device (e.g. Smartphone) or controls on the Soundbar(or the remote control) to play or pause audio, navigate tracks and control volume.

6. Disconnect Spotify from your Soundbar.

Press the icon (🔗) and you will see your smartphone (for example) on the list, press the item and Spotify will play via your smartphone. In addition, you can switch off your Soundbar or select a different operating mode.

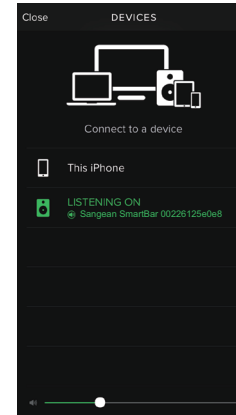

Display mode- Spotify Connect

Your soundbar has a range of display options when playing Spotify Connect.

1. Press and release the **Info** button to cycle through the different options
 - a. Progress bar Displays the playback progress for the track currently playing.
 - b. Artist Displays the name of the artist for the track currently playing.
 - c. Album Displays the name of the album from which the current track is taken.
 - d. Bit rate Displays the bit rate and sampling rate of the track currently playing.
 - e. Playback buffer Displays the soundbars internal buffer level.

Note:

If the Audio streaming from Spotify Connect is interrupted or stopped (e.g. control passed to another device), the message “Waiting for Users” is displayed.

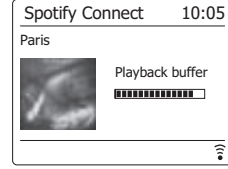
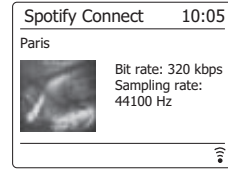
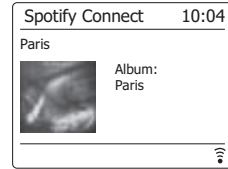
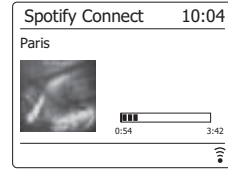

Listening to music via Bluetooth streaming

You need to pair your Bluetooth device with SB-100 before you can auto-link to play/stream Bluetooth music through your soundbar. Pairing creates a 'bond' so two devices can recognize each other.

Pairing and playing your Bluetooth device for the first time

1. Press and release the **On/Standby** button to switch on the soundbar.
Press the **Media** button on the remote control to select the Bluetooth mode. (Or press and release the **Mode** button on the soundbar and then use the **Menu Up** or **Down** and **Select** buttons to select the Bluetooth mode.)
Your soundbar will show that it is discoverable by flashing the Bluetooth indicator on the display.
2. Activate Bluetooth on your device according to the device's user manual to link to the soundbar.
Locate the Bluetooth device list and select the device named 'SB-100'. With some mobiles (which are equipped with earlier versions than BT2.1 Bluetooth device), you may need to input the pass code "0000".
3. Once connected, the name of your connected Bluetooth device will show on the display.
You can simply select and play any music from your source device. Volume control can be adjusted from your source device, or directly from the soundbar.
4. Use the controls on your Bluetooth-enabled device or on the soundbar to play/pause and navigate tracks.

Note:

- 1) If 2 Bluetooth devices, pairing for the first time, both search for your soundbar, it will show its availability on both devices. However, if one device links with this unit first, then the other Bluetooth device won't find it on the list.
- 2) If you take your source device out of range, the connection will be temporarily disconnected to your soundbar. Your soundbar will automatically reconnect if the source device is brought back in range. Be aware that during the period of disconnection, no other Bluetooth device can pair or link with your soundbar.
- 3) If 'SB-100' shows in your Bluetooth device list but your device cannot connect with it, please delete the item from your list and pair the device with the soundbar again following the steps described previously.
- 4) The effective operation range between the system and the paired device is approximately 10 meters (30 feet). Any obstacle between the system and the device can reduce the operational range.
- 5) Bluetooth/NFC connectivity performance may vary depending on the connected Bluetooth devices. Please refer to the Bluetooth capabilities of your device before connecting to your soundbar. All features may not be supported on some paired Bluetooth devices.



Playing audio files in Bluetooth mode

When you have successfully connected your soundbar with the chosen Bluetooth device you can start to play your music using the controls on your connected Bluetooth device.

1. Once playing has started adjust the volume to the required setting using the Volume buttons on your soundbar or on your enabled Bluetooth device.
2. Use the controls on your device to play/pause and navigate tracks. Alternatively, control the playback using Play/Pause (▶||), Next track (▶▶) , Previous track (◀◀) buttons on the soundbar.
3. Press and hold the Next or Previous button to move through the current track. Release the button when the desired point is reached.

Note:

- 1) That not all player applications or devices may respond to all of these controls.
- 2) When you make or receive calls, your soundbar will pause the music automatically to allow you to answer the phone. Such behaviour is a function of the connected device and does not indicate a fault with your soundbar.

Display modes – Bluetooth

Your soundbar has a range of display options when in Bluetooth mode. Note that the availability of information depends on the specific media format.

1. Press and release the **Info** button to cycle through the different options.
 - a. Title Displays the track information for the track currently playing.
 - b. Artist Displays the artist information for the track currently playing.
 - c. Album Displays the album information for the track currently playing.

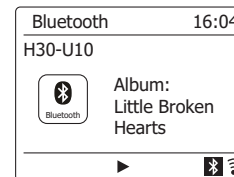
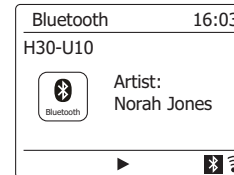
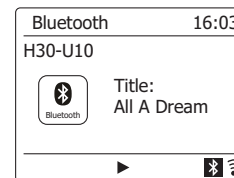

Speaker memory and reconnecting a device

Your soundbar can memorize up to 8 sets of paired device, when the memory exceed this amount, the oldest pairing history will be over written.

If your Bluetooth device already paired with the soundbar previously, the unit will memorize your Bluetooth device and it attempts to reconnect with a device in memory which is last connected. If the last connected device is not available, your soundbar will try to connect to the second last device, and so forth.

Alternatively, you can select to connect to your previously-paired device.

1. Press the **Media** button on the remote control to select the Bluetooth mode.
2. Press and hold the **Menu** button on the remote control to enter the Bluetooth menu.
3. Press the **Menu Up** or **Down** buttons until 'Paired Device list' is highlighted and then press the **Select** button to enter a list of previously connected devices.
4. Press the **Menu Up** or **Down** buttons to highlight a previously-paired device you would like to connect and press the **Select** button to confirm the selection.

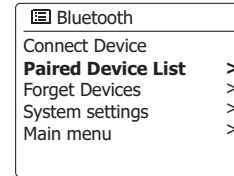

Deleting Bluetooth paired device memory

1. Press the **Media** button on the remote control to select the Bluetooth mode.
2. Press and hold the **Menu** button on the remote control to enter the Bluetooth menu.
3. Press the **Menu Up** or **Down** buttons until 'Forget Devices' is highlighted and then press the **Select** button to enter the setting menu.
4. 'Forget all devices?' will show on the display. Press the **Menu Left** and **Right** buttons to select 'YES' to clear the memory of all paired devices. Or select 'NO' to keep the memory. Press the **Select** button to confirm the selection.

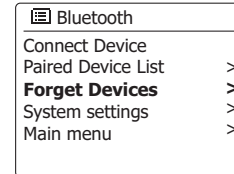

Disconnecting your Bluetooth device

1. Press and hold the **Menu** button on the remote control to enter the Bluetooth menu. Press the **Menu Up** or **Down** buttons until 'Connect Device' is highlighted and then press the **Select** button to confirm the selection. The Bluetooth indicator will flash on the display. Now your soundbar is discoverable again for pairing.
2. You can also turn off Bluetooth on your Bluetooth source device to disconnect with your Bluetooth device or select any mode other than Bluetooth mode to disable the connection.

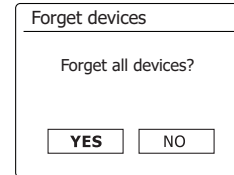

Pairing and playing your device via NFC

Your soundbar is equipped with wireless NFC (Near Field Communication) feature, allowing NFC enabled devices to pair and play the music with your soundbar. For non-NFC devices, please refer to the above sections for standard Bluetooth pairing.

1. Turn on your NFC feature on your device. (**Important:** Please make sure the screen of your playing device is **on and unlocked** to allow NFC to work.)
2. Touch the NFC area of your playing device against the NFC area located on the top of the soundbar.
The unit will enter automatic pairing mode. If you pair with the unit for the first time, some NFC enabled device will be asked the permission to link with the soundbar. Once paired with a device, 'Connecting SB-100...' or a similar message is shown on your NFC-enabled device.
3. Use the controls on your device or on your soundbar to play/pause and navigate tracks.

Note:

1. NFC connectivity performance may vary depending on the connected Bluetooth devices.
Please refer to the Bluetooth capabilities of your device before connecting to your soundbar. All features may not be supported on some Bluetooth/ NFC enabled devices.
2. The location of the NFC detection area is not the same on all devices. When connecting with other Bluetooth device via NFC, refer to the User guide of the other device for more information.
3. Some of metallic case or cover for mobile phones may reduce the sensitivity of NFC. Make sure you remove it, before activating the NFC.

Disconnecting your NFC-enabled device

To disconnect your device, simply touch it again on the top panel of the unit. (**Important:** Please make sure the screen of your playing device is **on and unlocked** to allow NFC to work.)

Clock and Alarms

Automatically updating the clock

Your soundbar will normally update the clock automatically when connected to the internet. If you enter a time setting manually, the soundbar will calculate a local time offset which is then stored in memory. Whenever it synchronises the clock using the internet, including after a power failure, your soundbar will then set the clock automatically using this information.

You may wish to use the soundbar away from the internet, in which case you may specify that the unit sets its clock from DAB or FM radio broadcasts. After a power failure the soundbar will then set its clock the next time that you turn on the radio in DAB or FM mode.

Alternatively you may specify that the time is not automatically updated. In this case the clock must always be set manually after a power interruption.

1. With your soundbar switched on, press and hold the **Menu** button to access the menu for the current mode.
2. Press the **Menu Up** or **Down** buttons until 'System settings' is highlighted on the display. Press and release the **Select** button to enter the System Settings menu.
3. Press the **Menu Up** or **Down** buttons until 'Time/Date' is highlighted on the display. Press and release the **Select** button to enter the time setup.
4. Press the **Menu Up** or **Down** buttons until 'Auto update' is highlighted on the display. Press and release the **Select** button to enter the Auto Update menu.
5. Press the **Menu Up** or **Down** buttons to choose an update option from 'Update from DAB', 'Update from FM', 'Update from Network' or 'No update' as required. Press and release the **Select** button to confirm your choice. The soundbar will then exit to the previous menu display.

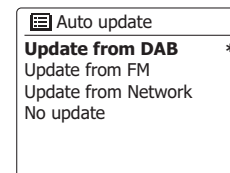
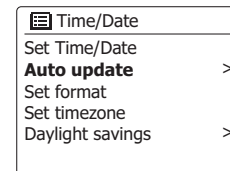
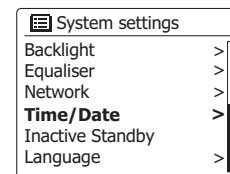
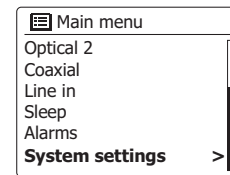
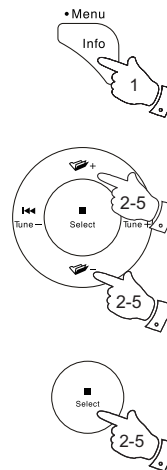

Setting the clock format

The clock display used in Standby mode and on the playing mode screens can be set to 12 or 24 hour format. The selected format is then also used when setting the alarms.

1. With your soundbar switched on, press and hold the **Menu** button to access the menu for the current mode.
2. Press the **Menu Up** or **Down** buttons until 'System settings' is highlighted on the display. Press and release the **Select** button to enter the System Settings menu.
3. Press the **Menu Up** or **Down** buttons until 'Time/Date' is highlighted on the display. Press and release the **Select** button to enter the time setup.
4. Press the **Menu Up** or **Down** buttons until 'Set format' is highlighted on the display. Press and release the **Select** button to enter the Clock Format menu.
The current clock display format is marked with an asterisk.
5. Press the **Menu Left** or **Right** buttons to select either 12 or 24 hour format. Press and release the **Select** button to confirm your choice of clock format. The display will then revert to the previous menu.

If the 12 hour clock format is chosen, the soundbar will then use the 12 hour clock for the setting of alarms, and will display a 12 hour clock with an AM or PM indicator when in standby mode.

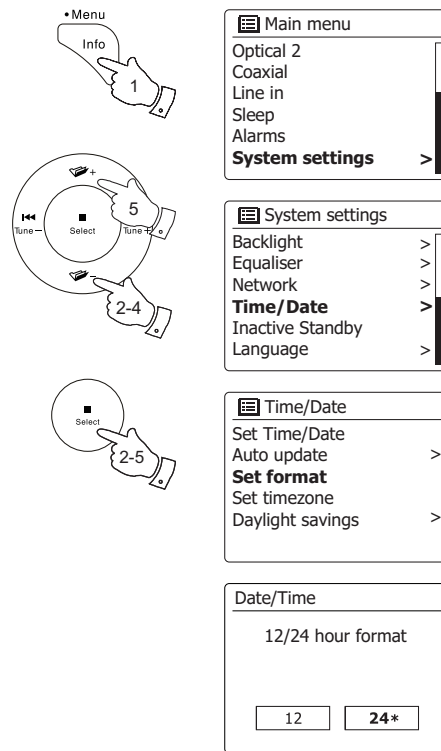

Manually setting the clock

After a connection to the Internet has been established, your soundbar will normally set its clock automatically to the local time zone that was specified during setup.

Should you need to set the time manually, change the time zone, or manually switch from winter to summer time (from GMT to BST in the UK, also commonly known outside the UK as daylight savings time), then please follow this procedure.

1. With your soundbar switched on, press and hold the **Clock set** button (on the remote control) and then skip to step 5 below. Alternatively press and hold the **Menu** button to access the menu for the current mode.
2. Press the **Menu Up** or **Down** buttons until 'System settings' is highlighted on the display. Press and release the **Select** button to enter the System Settings menu.
3. To change the time zone setting go to step 10. To change from winter to summer time go to step 12.
To change the current time or date setting press the **Menu Up** or **Down** buttons until 'Time/Date' is highlighted on the display, then press and release the **Select** button to enter the time and date setting screen.
4. Press the **Menu Up** or **Down** buttons until 'Set Time/Date' is highlighted on the display. Press and release the **Select** button to enter the clock setup. The day digits will flash.
5. Press the **Menu Up** or **Down** buttons until the correct day is shown on the display. Press and release the **Select** button to enter the selection. The month digits will then flash.
6. Press the **Menu Up** or **Down** buttons to select the correct month. Press and release the **Select** button to enter the selection. The year digits will then flash.

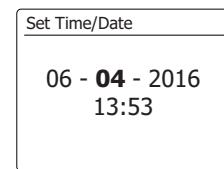
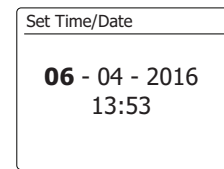
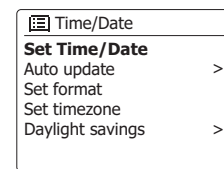
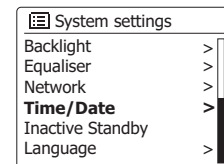
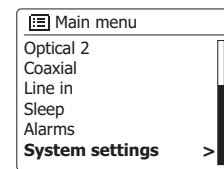
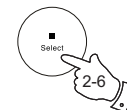
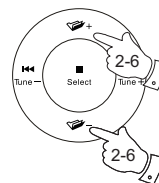
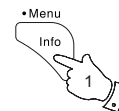
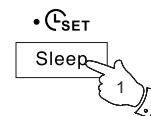

Manually setting the clock - cont.

7. Press the **Menu Up** or **Down** buttons to select the correct year. Press and release the **Select** button to enter the selection. The hour digits will then flash.
8. Press the **Menu Up** or **Down** buttons to select the correct hour. Press and release the **Select** button to enter the selection. The minute digits will then flash.
9. Press the **Menu Up** or **Down** buttons to select the correct minutes. Press and release the **Select** button to enter the selection. The display will then return to the previous menu.
10. Press the **Menu Up** or **Down** buttons until 'Set timezone' is highlighted on the display then press and release the **Select** button.
11. Press the **Menu Up** or **Down** buttons to highlight the time zone which is applicable to your location, press and release the **Select** button to confirm the setting.
Press the **Back** button to exit or go to step 12 to set the summer / winter time option.
12. Press the **Menu Up** or **Down** buttons until 'Daylight savings' is highlighted on the display then press and release the **Select** button. The asterisk shows the current setting.
In the UK, ON is equivalent to British Summer Time, OFF is equivalent to Greenwich Mean Time.
13. Press the **Menu Left** or **Right** buttons to highlight 'ON' or 'OFF' as required then press and release the **Select** button to confirm the setting. Press the **Back** button to exit.

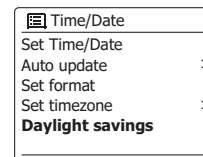
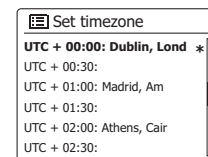
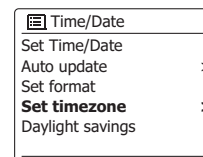
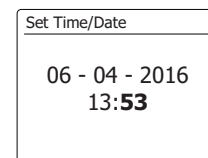
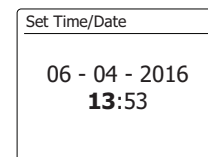
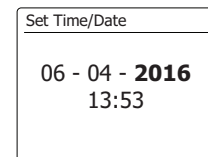
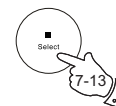
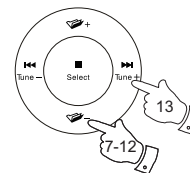

Setting the alarm clock

Your soundbar has two separate alarms which can be set to wake you to either the radio or a buzzer alarm. In the event of a power interruption your soundbar has built in memory that will retain your alarm settings. Ensure that the time is set correctly before setting the alarms.

Alarms may be set while the soundbar is in standby mode or switched on.

If your soundbar is being used as part of a multi-room system, please also see '*Alarm and Multi-room*'.

1. To change the states of the alarms while the soundbar is in Standby press the **Alarm** button on the remote control. The display will cycle through No Alarm, Alarm 1 enabled, Alarm 2 enabled or Alarms 1 and 2 enabled.
2. To change the alarm settings while the soundbar is in Standby, press and hold the **Alarm** button on the remote control. This will cause the Alarms menu to be displayed. Then skip to step 5 below.
3. To change the alarm settings while the soundbar is switched on, either press and release the **Alarm** button and then skip to step 5 below, or alternatively **press and hold** the **Menu** button to access the menu for the current mode. Press the **Menu Up** or **Down** buttons until 'Main menu' is highlighted on the display. Press and release the **Select** button to enter the Main menu.
4. Press the **Menu Up** or **Down** buttons until 'Alarms' is highlighted on the display. Press and release the **Select** button to see the current alarm settings. If no change is required, press the **Back** button to exit.
5. Press the **Menu Up** or **Down** buttons until the desired alarm (1 or 2) is highlighted on the display. Press and release the **Select** button to enter alarm setup.
6. Press the **Menu Up** or **Down** buttons until 'Time' is highlighted on the display. Press and release the **Select** button to adjust the alarm time.
7. Press the **Menu Up** or **Down** buttons to choose the alarm hour. Press and release the **Select** button to confirm the setting.

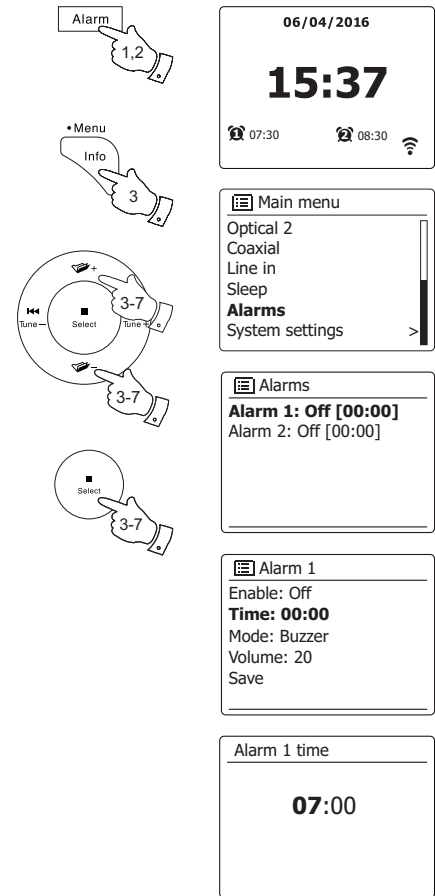

Setting the alarm clock - cont.

8. Press the **Menu Up** or **Down** buttons to choose the alarm minute. Press and release the **Select** button to confirm the setting. The display will then return to the alarm setting menu. If the soundbar has been set to use a 12 hour clock format, there will also be an option here for setting AM or PM for the alarm time.

9. Press the **Menu Up** or **Down** buttons to highlight 'Enable' and press and release the **Select** button. The display will show the Frequency options for the alarm. The alarm frequency options are as follows:

'Off' - the alarm will be disabled

'Daily'- the alarm will sound everyday

'Once'- the alarm will sound once

'Weekends' - the alarm will sound only at weekends

'Weekdays' - the alarm will sound on weekdays only

Press the **Menu Up** or **Down** buttons to choose the required alarm frequency option. Choosing Off will disable the alarm. Press and release the **Select** button to confirm the selection.

If you choose to set the alarm to Once you will also need to set the date using the **Menu Up** or **Down** and **Select** buttons.

10. The alarm can be set to buzzer, Internet radio, DAB or FM radio. For whichever radio mode is selected, the radio alarm may be set to any of the stations which have been stored as presets or to the station most recently listened to.

Press the **Menu Up** or **Down** buttons to highlight the current 'Mode' option for the alarm, then press and release the **Select** button if you wish to change it.

Press the **Menu Up** or **Down** buttons to highlight either 'Buzzer' or the required mode. Press and release the **Select** button to confirm the selection.

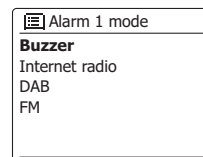
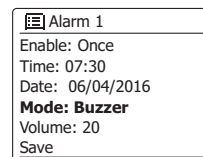
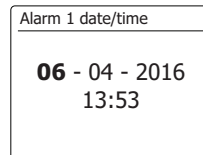
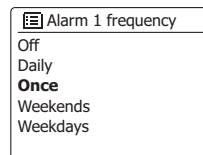
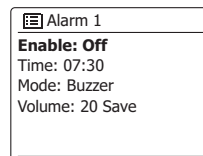
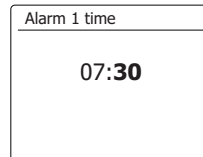
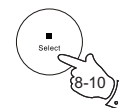
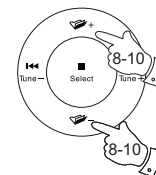

Setting the alarm clock - cont.

11. If setting the alarm to a radio option, press the **Menu Up** or **Down** buttons to highlight the 'Preset:' option then press and release the **Select** button if you wish to change it.

Choose from either the radio station 'Last listened' to, or from the presets 1 - 10. Scroll to the chosen option and press the **Select** button to confirm the selection.

Note: The alarm may only use a preset which has already been stored.

12. Press the **Menu Up** or **Down** buttons until the 'Volume:' option is highlighted on the display and press and release the **Select** button if you wish to change it. The soundbar uses the saved volume setting for each alarm when it sounds.

Press the **Menu Up** or **Down** buttons to set the required volume and then press and release the **Select** button to confirm the setting.

13. In order to store the alarm settings press the **Menu Up** or **Down** buttons until 'Save' is highlighted. Press and release the **Select** button to store the alarm settings. Your soundbar will show 'Alarm saved' and will then go back to the list of alarms with the new alarm setting shown in the display.

If you decide not to save the settings, press the **Back** button. The display will show 'Save changes' with a 'YES' or 'NO' option. Press and release the **Menu Left** or **Right** buttons to choose 'NO' and then press and release the **Select** button. 'Alarm not saved' will show on the display.

Active alarms are shown using small alarm indicators at the bottom of the playing displays and on the clock display when in Standby.

Note: If you make a mistake at any point while setting the alarms, use the **Back** button to go back to the previous screen.

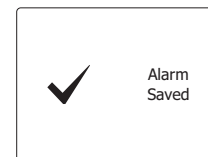
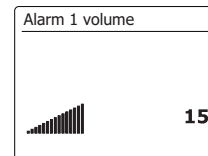
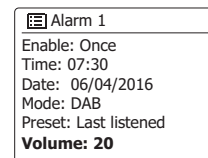
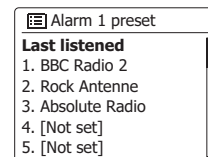
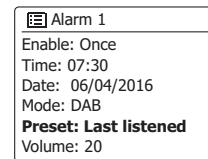
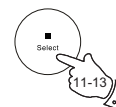
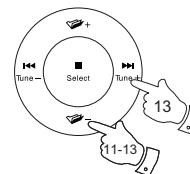

When the alarm sounds

The buzzer or radio alarm will sound at the selected times for up to 60 minutes unless cancelled. The volume used for the alarm will be as specified during the alarm setting procedure. If the radio cannot connect to the specified radio station, the buzzer alarm will be used instead.

During an alarm, the alarm icon will flash at the bottom of the playing mode displays. The soundbar will automatically revert to standby mode after 60 minutes.

To cancel an alarm, press the **On/Standby** button to return to Standby mode.

Note: If the radio is switched on because of an alarm you can control basic functions such as volume.

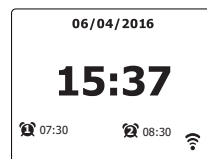
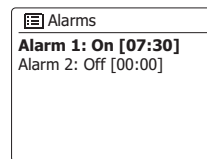

Snooze timer

1. The buzzer or radio alarm can be silenced for 5 minutes by pressing any button other than the On/Standby or Volume button. Should you wish for a longer snooze duration this can be extended. Pressing any button again other than the On/Standby or Volume button while the soundbar is snoozed will set the available snooze time to 5, 10, 15 or 30 minutes.
2. While the snooze timer is active the remaining snooze time is shown next to the flashing alarm icon on the clock display.
3. In order to cancel the Snooze timer while the alarm is suspended, press the **On/Standby** button. The display will briefly show an 'Alarm Off' message.



Disabling alarms

1. To disable an alarm while the soundbar is in standby mode press and release the **Alarm** button to cycle through the alarm on-off options.
2. To disable an alarm while the soundbar is playing enter the Alarms menu and press the **Menu Up** or **Down** buttons until the desired alarm is highlighted on the display. Press the **Select** button.
3. Press the **Menu Up** or **Down** buttons until the 'Enable:' option is highlighted on the display. Press and release the **Select** button.
4. Press the **Menu Up** or **Down** buttons to highlight 'Off ' and press and release the **Select** button.
5. Press the **Menu Up** or **Down** buttons until the 'Save' option is highlighted on the display then press and release the **Select** button to save the new setting. The chosen alarm will now be disabled.

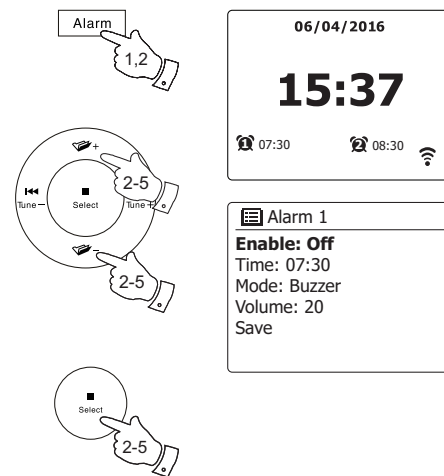

Sleep timer

Your soundbar can be set to turn off after a preset time has elapsed. The sleep timer setting can be adjusted between 15 and 60 minutes in 15 minute increments.

1. With your soundbar switched on, press and release the **Sleep** button on the remote control.
2. Press and release the **Sleep** button on the remote control or press the **Menu Up** or **Down** buttons until the required sleep time setting is selected. The sleep timer can be set to between 15 and 60 minutes, or to Off. Press and release the **Select** button to confirm the setting.
3. The sleep timer will be set to the chosen duration. An active sleep timer is shown using a small timer indicator at the bottom of the playing displays. This indicator also shows the sleep time remaining before the radio switches itself into Standby mode.
4. Alternatively you can set the sleep time using the menu system. Access the menu for the current mode by **pressing and holding** the **Menu** button. Press the **Menu Up** or **Down** buttons until 'Main menu' is highlighted on the display. Press and release the **Select** button to enter the Main menu.
5. Press the **Menu Up** or **Down** buttons until 'Sleep' is highlighted on the display then press and release the **Select** button.
6. Press the **Menu Up** or **Down** buttons until the required sleep time setting is selected. Press and release the **Select** button to confirm the setting.
7. To cancel the sleep time before the preset time has elapsed and to turn off the soundbar, press the **On/Standby** button to turn the unit off manually.
To cancel the sleep timer and leave the soundbar playing, go back into the sleep timer settings (steps 1 to 2 above) and select the Off option in step 2.

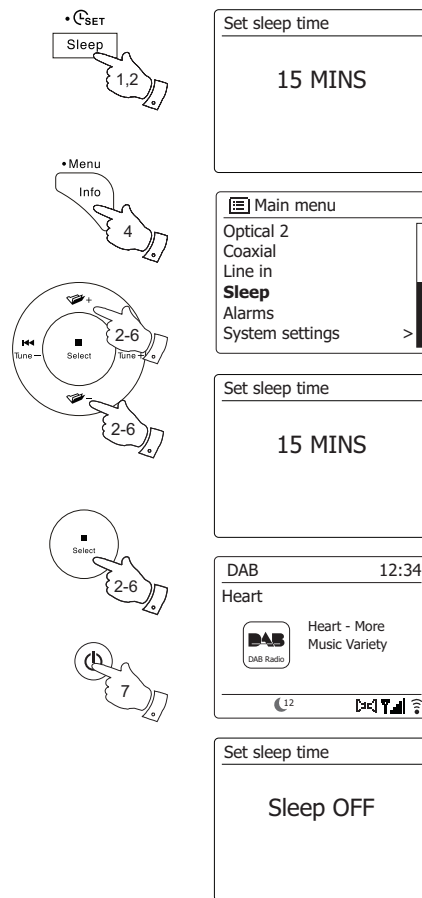



Multi-room and UNDOK

SB-100 is part of Sangean SmartLink multi-room series. This series has 'Multi-room' feature allowing the same music to be played simultaneously through Sangean SmartLink Series (i.e. multi-room capable devices) with users being able to share music on their home network and also from Spotify, Internet radio and other music source. In this home network, multi-room capable devices can be treated as individual or organised into synchronized groups. Within each group of audio devices one device must be the master and all others in the group are clients.

To enjoy music with this feature, you can download UNDOK App on your smartphone/tablet to control all the audio sources available in your Sangean SmartLink devices everywhere in your home.

When using your soundbar while watching TV the multi-room function is normally disabled with the TV sound being only available from the soundbar. This is because the delays associated with sharing the sound with other multi-room devices and keeping them all in step would result in the sound being noticeably delayed compared to the image on the TV.

Note: The images used below extract from Android device. If your device uses iOS Apple or different UNDOK version, the display may be slightly different.

1. To use multi-room feature, download UNDOK app  from App Store for your iOS smartphone or download from Google Play for your Android smartphone.
2. Start UNDOK app, making sure your soundbar and smartphone are connected to the same WiFi network.
3. All devices which are capable of multi-room grouping but currently not in a group will be listed on the screen of your smartphone. Select the soundbar, for example "Sangean SB-100 xxxxxxxxxxxx" (the 12 digit alphanumeric code is the MAC address of your soundbar) to establish a connection between UNDOK and your soundbar. Now you can create a multi-room group where you can play the same music everywhere or listen to individual tracks in different rooms simultaneously. If no device shown on the display, tap the 'SET UP AUDIO SYSTEM' on the bottom left corner to help configure your device to your WiFi network.
4. **To create a group:** Create a group by tapping on the icon  next to an audio device. The App will suggest a default name which you can overwrite as required. Note that the group name can be up to 32 characters and contain letters, numbers, spaces and most characters available on a standard qwerty keyboard.
5. When you are happy with the group name, select the audio products that you wish to add into your group. After finish adding the device, tap Done.
6. **To add or remove devices to/from a group:** Manage the audio devices by check/uncheck their checkbox and tap Done. After each change in the group structure, the My Home list info is refreshed.
7. **To ungroup or remove a group:** Tap "DELETE GROUP".

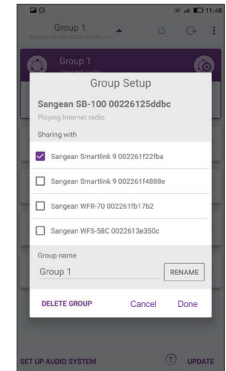
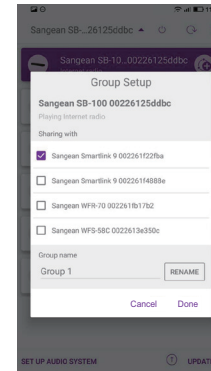
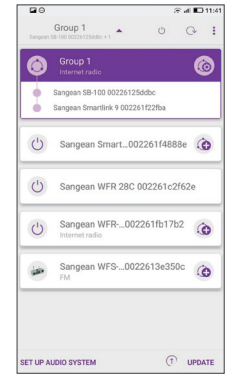
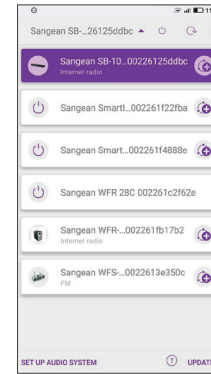

8. Alternatively, you can manage groups via your soundbar itself. Enter **Menu** of current mode> **System settings**> **Multi-room**> press the Select button to enter the setting menu as below:

- a. **Create new group:** Create a new group that your soundbar will be joined. Enter 'Create new group' option> Insert group name and select 'ok' when completed> 'Created' will show on the display indicating a group is created> your soundbar will detect devices which are capable of multi-room grouping but currently not in a group> select your required client device and "Added" is shown when the device is added successfully> you can now select any listening mode (i.e Spotify/FM etc.) and the selected audio will be played via all the devices in this group. If your soundbar is a client in a group, 'Playback buffer' is shown on the display.
- b. **Add to group:** Devices in current network will be listed. Select the client you desired to add to the group which your soundbar belong to.
- c. **View details:** View your soundbar state (Ungrouped, Server or Client) and the group which it belongs to.
 - Ungrouped - The product is not part of a group.
 - Server - The product sends audio content to other group members.
 - Client - The product receives audio from another product in the group.
- d. **List current clients:** Clients in the group which your soundbar belong to will be listed. Select the client you want to remove from a group.
- e. **Leave group:** Remove your soundbar from a group.
- f. **Dissolve group:** Dissolve the group which your soundbar belong to.

Insert group name

| | | | | | | | |
|---|---|---|---|---|---|--------|------|
| 0 | 1 | 2 | 3 | 4 | 5 | 6 | BKSP |
| 7 | 8 | 9 | . | - | @ | OK | |
| , | a | b | c | d | e | CANCEL | |
| f | g | h | i | j | k | l | |
| m | n | o | p | q | r | s | |



Add to group

Sangean Smartlink 9 0022

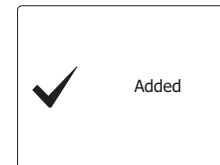

Multi-room 00:00

Playback buffer

Progress bar

Alarms and Multi-room

If your soundbar is configured as part of a multi-room group, then the soundbar will remove itself from that group when the soundbar switches itself on as a result of an alarm having been set. This is so that an alarm sounding on one radio will not cause all of the other products in the group to be activated at the same time.

If you wish to use your soundbar as part of a multi-room group after using the alarm function, you will need to add the soundbar back into the group manually. This is most easily performed using the UNDOK app.

UNDOK display options

1. Source: Select the desired source mode.
2. Now Playing& Browse : Select 'Now Playing' or 'Browse' as needed to access content for the selected source.

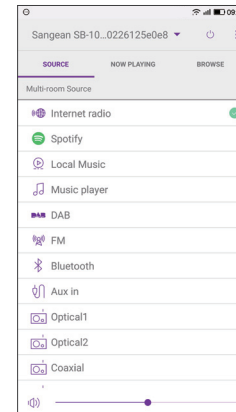

UNDOK Settings

Equaliser function

The sound on your soundbar can be adjusted to suit your personal taste for the material that you are listening to. The SB-100 has a range of equaliser modes. Alternatively you may set the bass, mid-range and treble levels to your own preferences.

1. Select the 'Settings' screen and then select 'Equaliser' in UNDOK.
2. Choose the desired equaliser setting or select the 'My EQ' option to adjust the bass, mid-range and treble setting.

Sleep timer

Your soundbar can be set to turn off after a preset time has elapsed. The sleep setting can be adjusted as follows.

1. Set the sleep timer using the UNDOK app.
2. Your soundbar will switch off after the preset sleep timer has elapsed.

Friendly name

Your soundbar is identified within the UNDOK app using its Friendly Name. By default, your soundbar's name will be shown as "Sangean SB-100" followed by a 12 digit alphanumeric code which is the network MAC address that is unique to your soundbar. Tap 'RENAME' on the screen to change its friendly name.

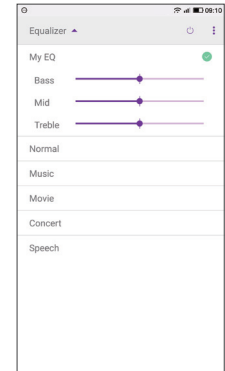
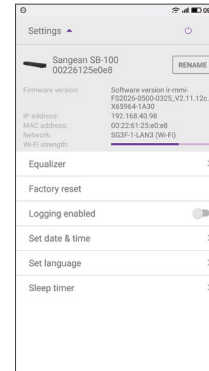

Display and Audio

TV audio options

For most of its operating modes, the soundbar is able to share audio with other connected multi-room products. So, for example, you could choose to listen to an Internet Radio station, to a Spotify selection, or to an external device such as an MP3 player, and have the sound played through the soundbar and shared with up to four other devices at the same time. The exception to this is when watching the TV.

When using your soundbar while watching TV the multi-room function is normally disabled with the TV sound being only available from the soundbar. This is because the delays associated with sharing the sound with other multi-room devices and keeping them all in step would result in the sound being noticeably delayed compared to the image on the TV.

The soundbar's setting allow on input to be specified as the TV audio input. This input is then not shared with the other multi-room devices and is played without significant delay. This is set using the 'TV Audio Input' menu. When playing from other sources to a group of multi-room products there is a very short delay added, but is it only about half a second. In this case, all the connected devices will play with their sound fully synchronised.

If you do wish to have TV sound shared with other connected multi-room products, then you may choose the 'None' option in the 'TV Audio Input' menu. However, this will result in a noticeable delay between the TV image and the accompanying video. In addition, if using either the Auxiliary Input or the Line Input, then the volume setting on the soundbar may need to be lowered, and possibly also the subwoofer and bass levels using the equaliser options.

Specifying the input to be used for TV Audio

To specify which input is to be used for audio from your TV, please follow these steps.

1. With your soundbar switched on, press and hold the **Menu** button.
2. Press the **Menu Up** or **Down** buttons until 'System setting' is highlighted.
3. Press and release the **Select** button to enter the settings menu.
4. Press the **Menu Up** or **Down** buttons until 'TV Audio Input' is highlighted. Press and release the **Select** button.
5. Press the **Menu Up** or **Down** buttons until the input to be used for TV audio is highlighted.
The example in the illustration to the right shows the Optical 1 input is selected.
6. Press and release the **Select** button to enter the settings menu.
7. The soundbar will switch to start playing audio from that input.

Once this option has been set in the soundbar, you simply press and release the **Media** button on the remote control to select the appropriate input on the soundbar for TV listening when needed. You do not need to use this settings menu each time.

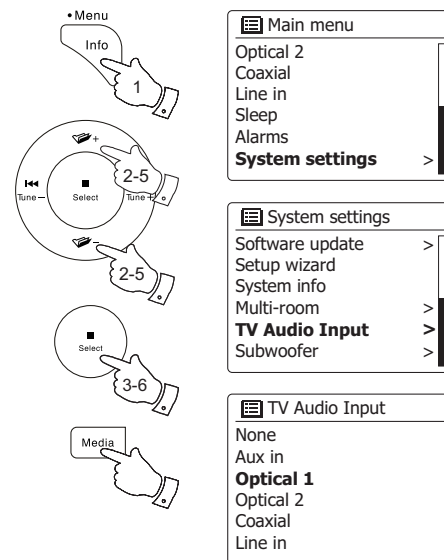

Audio and Display behaviour when using the TV Audio Input

When listening to soundbar using the input which you have assigned as the TV Audio Input, the following will apply.

- a) Sound is only played through the soundbar.
- b) Other connected multi-room products in the same group will switch on but will remain silent.
- c) The display backlight on the soundbar will be switched almost completely off so that the display does not distract from TV viewing. The display will bright up to the 'Normal' brightness setting and the buttons will light up for 10 seconds after any operation such as a volume change.
- d) If the Auxiliary input or Line input is being used for the audio from the TV, then the input sensitivity of that input is reduced to match the typical signal level from the analogue outputs of TVs, cable and satellite receivers, etc.

When any other operating mode or any input not assigned to the TV Audio function is selected, normal multi-room operation and backlight operation is restored.

Equaliser function

The sound on your soundbar can be adjusted to suit your personal taste for the material that you are listening to. The SB-100 has a range of equaliser options. Alternatively you may set the bass, mid-range and treble levels to your own preferences which can be accessed from the My EQ menu item.

1. Press the **On/Standby** button to switch on your soundbar.
2. Press the **EQ** button (on the remote control) to access the EQ menu and then skip to step 5 below. Alternatively to access the EQ menu, press and hold the **Menu** button.
3. Press the **Menu Up** or **Down** buttons until 'System settings' is highlighted on the display. Press and release the **Select** button to enter the System Settings menu.
4. Press the **Menu Up** or **Down** buttons until 'Equaliser' is highlighted on the display. Press and release the **Select** button.
5. Press the **Menu Up** or **Down** buttons to cycle through and highlight the various modes. Press and release the **Select** button to confirm your selection.
 - a - 'Normal'
 - b - 'Music'
 - c - 'Movie'
 - d - 'Concert'
 - e - 'Speech'
 - f - 'My EQ'

The currently selected mode is marked with an asterisk.

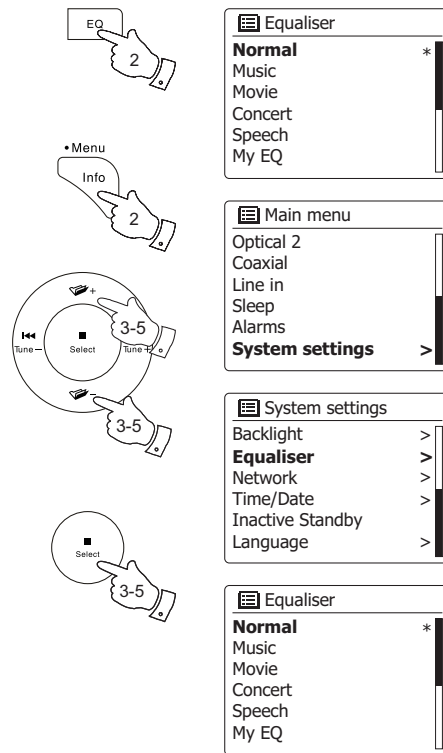

Setting up your My EQ profile

If you find the preset equaliser functions not to your liking, you may set up a custom bass, mid-range and treble setting as follows:

1. Follow steps 1-4 on the preceding page in order to enter the Equaliser menu.
2. Press the **Menu Up** or **Down** buttons until 'My EQ profile setup' is highlighted on the display. Press and release the **Select** button to enter the adjustment mode.
3. To adjust the bass level press the **Menu Up** or **Down** buttons until 'Bass' is highlighted on the display. Press and release the **Select** button to enter the adjustment mode and press the **Menu Up** or **Down** buttons until the desired level (between -6 and +6) is displayed. The sound will change as you adjust the levels. Press and release the **Select** button when you are happy with the bass setting.
4. To adjust the mid-range or treble level press the **Menu Up** or **Down** buttons until 'Mid' or 'Treble' is highlighted on the display. Press and release the **Select** button to enter adjustment mode and press the **Menu Up** or **Down** buttons until the desired level (between -6 and +6) is displayed. The sound will change as you adjust the level. Press and release the **Select** button when you are happy with the mid-range or treble setting.
5. Press the **Back** button and the display will prompt you to save the changes. If you wish to save the changes press the **Left** or **Right** buttons to highlight 'YES'. If you do not wish to save the changes highlight 'NO'. Press and release the **Select** button to enter the selection.
6. To use the 'My EQ' profile press the **Menu Up** or **Down** buttons until 'My EQ' is highlighted, and then press and release the **Select** button to make the selection.

To quickly cancel the effect of the 'My EQ' profile press the **Menu Up** or **Down** buttons until 'Normal' is highlighted on the display and press and release the **Select** button. The bass, mid-range and treble settings will be remembered for the next time that you wish to use the 'My EQ' setting.

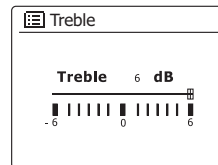
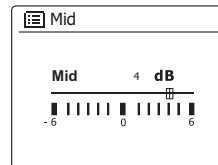
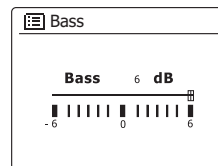
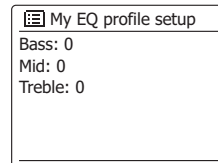
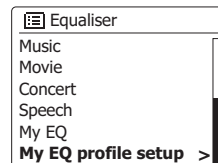

Subwoofer control

The soundbar has an additional control for the subwoofer function. This controls the level of deep bass from the soundbar's loudspeakers, and it also controls the signal level which is fed to an external subwoofer if connected.

If your soundbar or subwoofer is located in the corner of a room (especially on the diagonal) then you may need to reduce the subwoofer volume setting on the soundbar. This is because the reflections from the walls around the corner will tend to enhance the bass response of the system. Conversely, in a large open area, you may wish to increase the subwoofer volume setting on the soundbar.

1. The subwoofer volume control on the soundbar remote control adjusts levels of the internal subwoofer function and also the signal levels to an external subwoofer.
2. Alternatively, the subwoofer level setting in the system settings menu can be used to adjust the subwoofer level.

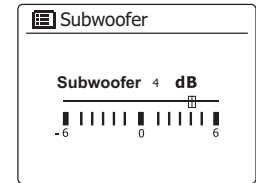
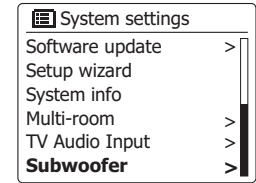
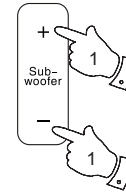

Mute function

Pressing the Mute button will mute the output from the loudspeakers.

1. Press the **Mute** button (on the remote control) to mute the sound output.
2. Press the **Mute** button again or one of the volume buttons to un-mute the sound output.



Brightness control

The brightness of the display can be adjusted for when the soundbar is in standby and for when it is in use. If you use the unit in the bedroom, you may prefer a lower standby brightness level than the standard setting. There are a range of Standby brightness levels and a range for when the soundbar is in use. To change the current brightness setting, please follow these steps.

1. Press the **On/Standby** button to switch on your soundbar. Access the menu for the current mode, press and hold the **Menu** button.
2. Press the **Menu Up** or **Down** buttons until 'System settings' is highlighted on the display. Press and release the **Select** button to enter the System Settings menu.
Press the **Menu Up** or **Down** buttons until 'Backlight' is highlighted on the display. Press and release the **Select** button
3. To adjust the display brightness when the soundbar is switched on press the **Menu Up** or **Down** buttons until 'Normal' is highlighted on the display.
To adjust the display brightness when the soundbar is in standby press the **Menu Up** or **Down** buttons until 'Standby' is highlighted.
Press and release the **Select** button to enter the selected brightness adjustment mode. The current setting will be marked with an asterisk.
4. Press the **Menu Up** or **Down** buttons to choose the desired brightness level. Press and release the **Select** button to set the level. Press the **Menu** button to exit.

When the soundbar is in Standby mode, pressing a button will cause the soundbar to switch to the normal brightness level for a few seconds. This is so that even if the standby brightness level is set low, it is still possible to see the time when needed.

The settings in Standby mode are lower than their equivalents when the soundbar is in use.

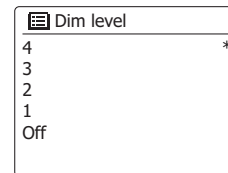
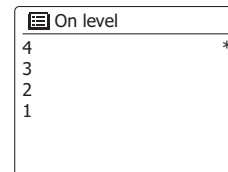
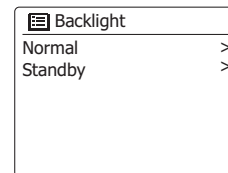
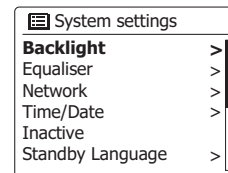
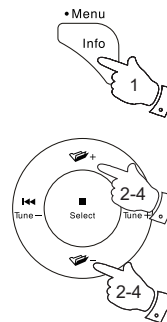

Inactive Standby timer

The Inactive Standby timer allows your soundbar to save power by automatically going to Standby if no controls are used for a period of time. By default this period is set to 8 hours but you may change it if you wish.

1. With your soundbar switched on, access the menu for the current mode, press and hold the **Menu** button.
2. Press the **Menu Up** or **Down** buttons until 'System settings' is highlighted and press and release the **Select** button.
3. Press the **Menu Up** or **Down** buttons until 'Inactive Standby' is highlighted and press and release the **Select** button.
4. Choose from 2, 4, 6, 8 hours or Off. Your soundbar will go into Standby after the selected time has expired. Setting Inactive Standby to Off will disable this feature.

Note that if the sleep timer is used then the sleep timer will override this setting.

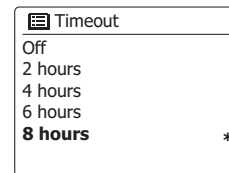
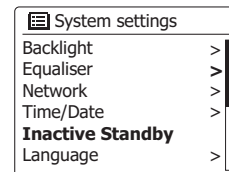
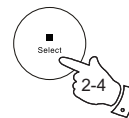
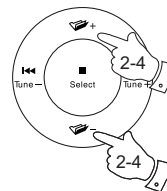
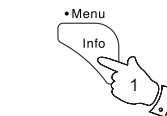

Language selection

By default your soundbar will display all menus and messages in English. You can choose your preferred language.

1. Access the menu for the current mode by pressing and holding the Menu button. Press the **Menu Up** or **Down** buttons until 'System settings' is highlighted on the display. Press the **Select** button to enter the settings menu.
2. Press the **Menu Up** or **Down** buttons until 'Language' is highlighted on the display. Press the Select button to enter the menu.
3. Press the **Menu Up** or **Down** buttons until your preferred language is highlighted and press the **Select** button to confirm the setting.

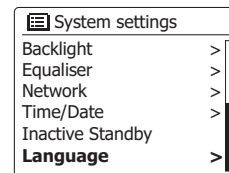

Information

Factory reset

If you wish to completely reset your soundbar to its initial state this may be performed by following this procedure. By performing a factory reset, all user entered settings will be erased.

1. To access the menu for the current mode, press and hold the **Menu** button. Press the **Menu Up** or **Down** buttons to highlight the 'Main menu' option, then press and release the **Select** button to select.
2. Press the **Menu Up** or **Down** buttons until 'System settings' is highlighted and then press and release the **Select** button to select.
3. Press the **Menu Up** or **Down** buttons until 'Factory reset' is highlighted and then press and release the **Select** button. Press the **Menu Left** or **Right** buttons and highlight 'YES' to proceed. If you do not wish to carry out a system reset, highlight 'NO' and then press and release the **Select** button. The display will revert to the previous menu.
4. With 'YES' highlighted, press and release the **Select** button. A full reset will be performed and the soundbar will restart as if first plugged in. The DAB stations list together with any preset stations will be erased and your wireless network connection details will be lost. All configuration settings will be restored to their defaults, the clock and alarms will be reset.

In case of malfunction for any reason, reset the product as described above to resume normal operation. It may be necessary in some cases to disconnect the mains power, then reconnect power after 10 seconds.

In case of malfunction due to electrical fast transient (burst), reset the product as above (reconnection of the power source may be required) to resume normal operation.

When connecting the soundbar to a router with an Ethernet cable, shielded cable is highly recommended. The communication could be interrupted temporarily or noise may occur if using un-shielded cable and under strong local interference (between 43 and 80MHz). Normal communication will resume automatically when the interference signal is removed. FM radio reception may also benefit from the use of a shielded cable.

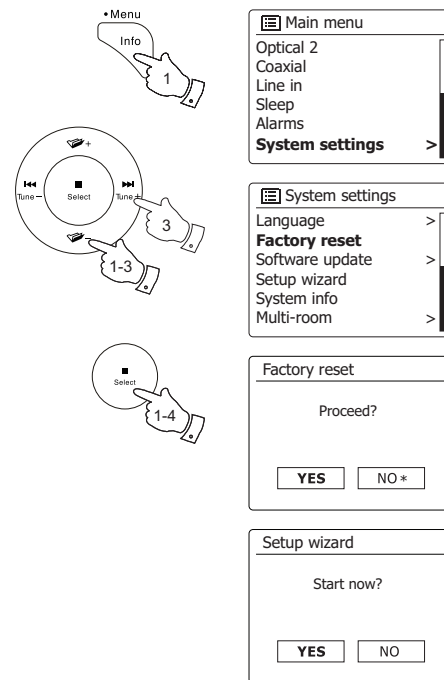

Software update

From time to time, new software features for your soundbar may be developed. Your soundbar has therefore been designed to allow its internal software to be updated using your Internet connection.

You should not attempt to update your soundbar unless it is recommended to you by Sangean Customer Services. Updating the software may remove all network settings, radio station presets and alarm settings from your soundbar.

It is important that you do not attempt this procedure unless you have a good Internet connection and a reliable mains power supply. If the soundbar connects to your router using a WiFi connection, make sure that this is also reliable before proceeding.

1. The 'Software update' option is accessed via the System Settings menu. When you select 'Software update' the menu will display 'Auto check setting' and 'Check now'. If you want your soundbar to check periodically for new software versions press the **Menu Up** or **Down** buttons to highlight 'Auto check settings'. Then press and release the **Select** button and select 'YES'. If you do not want your soundbar to check for updates select the 'NO' option.
2. To check if there are any software updates available currently, press the **Menu Up** or **Down** buttons to highlight 'Check now' and then press and release the **Select** button. The soundbar will check to see if an update is available. The display will show 'Checking for new versions'. If there are no updates then the display will show 'Software up to date'. If a software update is available your soundbar will then offer the choice of updating the software or not, displaying 'New version available. Update software?'. Select the 'YES' option if you wish to go through the update process.
3. If you choose to update your soundbar it will first download the new software and will then reprogram its internal memory. This may take anything from a few seconds to a few minutes depending on the speed of your internet connection.
4. Once the software update is completed, the soundbar will prompt you to press **Select** to restart. Press and release the **Select** button and your soundbar will then restart. You may find that you will need to reconfigure your network connection following an update. You may also need to re-enter all radio station presets, alarm settings, and configuration options.

VERY IMPORTANT: Do not switch off the power to the soundbar until the update operation is complete and the soundbar has restarted, otherwise the unit may become permanently damaged.

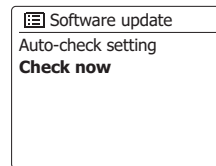
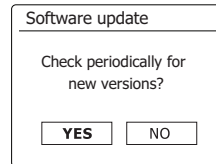
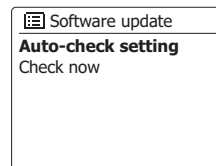
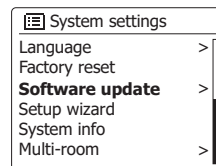
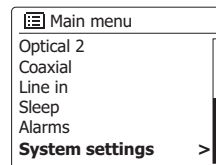

Network profiles

Each time that you connect your soundbar to a WiFi network, the soundbar will store the details of that connection (SSID, security key, DHCP/IP address settings) as a profile. Up to four such profiles are stored in the soundbar so that if the unit is used in multiple locations there is no need to enter the network settings when returning to a location previously visited.

The soundbar stores the four most recent profiles in memory identified by their SSID. Normally the soundbar will attempt to connect to one of the stored profiles and only if it is unable to do so will you need to use the Network Wizard.

In the event that you visit a location only once you may wish to delete the profile for the network in that location to avoid losing other profiles.

1. To access the menu for the current mode, **press and hold** the **Menu** button.
2. Press the **Menu Up** or **Down** buttons until 'System settings' is highlighted on the display. Press and release the **Select** button to enter the System Settings menu.
3. Press the **Menu Up** or **Down** buttons until 'Network' is highlighted on the display. Press and release the **Select** button to enter the Network Settings menu.
4. Press the **Menu Up** or **Down** buttons until 'Network profile' is highlighted on the display. Press and release the **Select** button to see the stored profiles. The profile which is currently in use (if any) is marked with an asterisk.
5. To remove a profile from memory, press the **Menu Up** or **Down** buttons to highlight the profile to be deleted and then press and release the **Select** button.
6. The soundbar will offer a 'YES' or 'NO' selection. Press the **Menu Left** or **Right** buttons to select 'YES' and then press and release the **Select** button. The selected profile will be deleted.

Note: It is not possible to delete a profile which is currently in use.

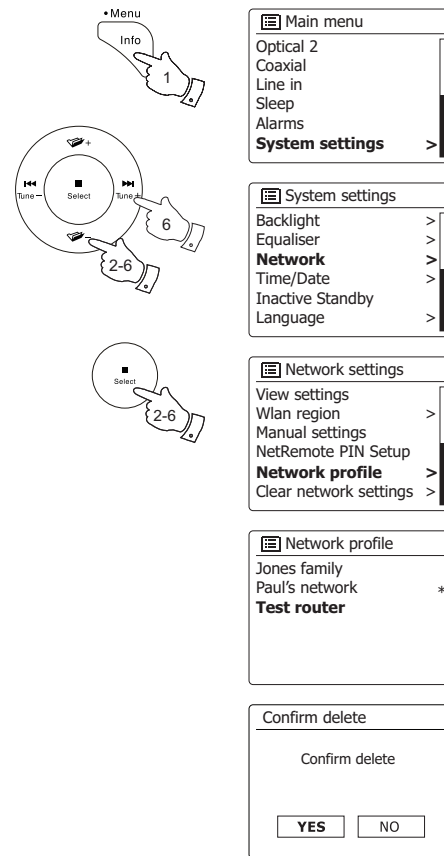

Clear network settings

In the event that you pass your soundbar on to someone else you may wish to remove all the network settings stored. This function will clear all stored network settings from your soundbar.

1. To access the menu for the current mode, press and hold the **Menu** button.
2. Press the **Menu Up** or **Down** buttons until 'System settings' is highlighted on the display. Press and release the **Select** button to enter the settings menu.
3. Press the **Menu Up** or **Down** buttons until 'Network' is highlighted on the display. Press and release the **Select** button to enter the Network settings menu.
4. Press the **Menu Up** or **Down** buttons until 'Clear network settings' is highlighted on the display. Press and release the **Select** button.
5. The soundbar will offer a 'YES' or 'NO' selection. Press the **Menu Left** or **Right** buttons to select 'YES' and then press and release the **Select** button. The network settings will be deleted.
6. If you do not wish to clear the network settings, highlight 'NO' and then press and release the **Select** button. The display will revert to the previous menu.

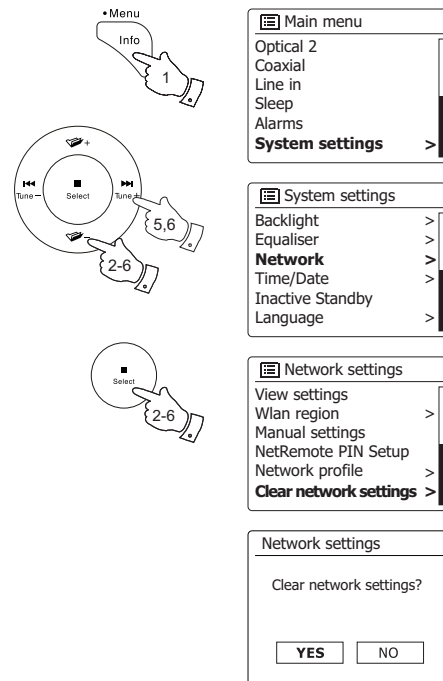

Manual network configuration

If you do not wish to use DHCP for automatic network configuration, or if your network is configured with a hidden SSID, then you will need to enter some network settings manually. The typical user will not need to use manual network configuration. The facility is provided to allow the product is to be used with networks where the configuration of devices is not managed by the router, or where customized settings may be required. In such cases it is assumed that the user already has sufficient knowledge to understand the terms and settings used for this purpose. IPv4 address schemes are used.

1. From the soundbar's Network Settings menu, select 'Manual settings'. You must then choose whether to connect using 'Wired' or 'Wireless' connections. If you choose 'Wireless' there are as many as nine settings screens, shown by the '1 of 9' progress marker in the top right corner of the display. If you choose 'Wired' there are five screens and the progress marker will reflect this, although the steps to set up the network parameters are basically the same.

2. The subsequent menus allow configuration of the following parameters:

- DHCP - On or Off
- IP address - e.g. 129.168.1.25
- Subnet mask - e.g. 255.255.255.0
- Gateway address - e.g. 129.168.1.1
- DNS address (primary and secondary addresses)
- SSID - needed for WiFi connections if the SSID is not broadcast
- WEP / WPA / WPA2 key and settings

When entering numbers, the SSID or the WiFi pass key, the three controls on the right-hand side of the screen have special functions. You can quickly access these by pressing the **Info** button and then use the **Menu Up** or **Down** and the **Select** buttons as needed:

- select **[BKSP]** to erase a character just entered (long press to clear); **Info** again to continue
- select **[OK]** when the complete encryption key has been entered
- select **[CANCEL]** to cancel and go back to the TKIP / AES options screen

3. Upon completion of the settings the soundbar should connect to the network. If the connection is made successfully, the soundbar will return to the Network Settings menu. If the unit cannot connect, then it will display a 'Failed to connect' message. You will then need to identify which setting may need to be changed, or whether some other network issue is responsible. Once connected, the network settings are saved. They are retained in memory while the soundbar is disconnected from the mains.

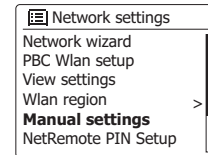
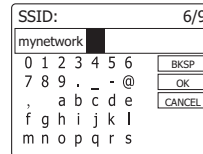
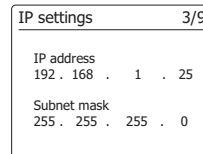
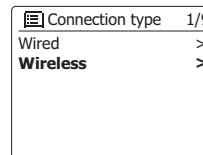
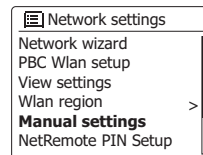

Software version display

The software version display is provided for reference and customer support purposes.

1. To access the menu for the current mode, press and hold the **Menu** button.
2. Press the **Menu Up** or **Down** buttons until 'System settings' is highlighted on the display. Press and release the **Select** button to enter the System Settings menu.
3. Press the **Menu Up** or **Down** buttons until 'System Info' is highlighted on the display. Press and release the **Select** button to display the software version and radio ID. Press the **Menu Up** or **Down** buttons to display further information.
4. Press the **Menu** button to exit.

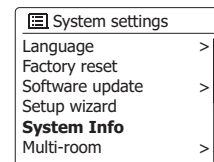
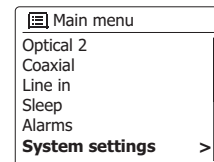
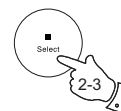
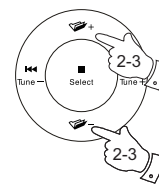

Audio FAQ

Your soundbar can access some audio help for Internet Radio use.

1. With your soundbar switched on and in the **Internet Radio** mode, press and hold the **Menu** button.
2. Press the **Menu Up** or **Down** buttons until 'Station list' is highlighted on the display. Press and release the **Select** button.
3. Press the **Menu Up** or **Down** buttons until 'Help' is highlighted on the display. Press and release the **Select** button to enter the Help menu.
4. Press the **Menu Up** or **Down** buttons until 'FAQ' is highlighted. Press and release the **Select** button to display some frequently asked questions.
5. Press the **Menu Up** or **Down** buttons to choose a question that suits your requirements and press and release the **Select** button to listen to the answer. Adjust the volume as needed.

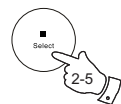
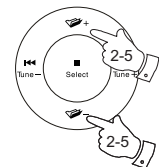
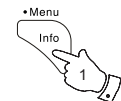

Audio codecs

Your soundbar supports a range of audio codecs which provide compatibility with a wide range of Internet Radio stations. These also allow users to stream music from their computers or other DLNA compatible sources.

Note that for any given audio codec, there are many streaming protocols available, and thus even if an Internet Radio station uses a supported format, this does not guarantee that every such station will work with your soundbar. The radio stations database to which your soundbar connects is checked for compatibility so that most stations should be playable without problems. Similarly when streaming media from a computer, while a codec may be supported, there can be many subtle variations in formats, tagging schemes and protocols (even within UPnP). In general your soundbar will play the supported formats with most common UPnP servers.

The following table summarises the maximum supported bit-rates for the various audio formats that are playable on your soundbar. Higher rates may be playable in some cases but performance of the product may be affected.

| Codec | Maximum supported data rate |
|---------------------|-----------------------------|
| AAC (LC, HE, HE V2) | 320 kbits/sec |
| ALAC (1) (5) | 1.5 Mbits/sec |
| FLAC (2) (5) | 1.5 Mbits/sec |
| LPCM (3) | 1.536 Mbits/sec |
| MP3 | 320 kbits/sec |
| WAV (3) | 1.536 Mbits/sec |
| WMA (4) | 320 kbits/sec |

All codecs support 2-channel (stereo) coded files only.

All codecs support sample rates up to 48k samples/sec (includes 32 k and 44.1 k samples/sec).

Files which have Digital Rights Management (DRM) protection applied will not be playable on your soundbar.

- (1) 16 bit samples are supported in ALAC files.
- (2) 16 and 24 bit samples are supported in FLAC files.
- (3) The maximum supported bit-rate is for 48 kHz sampling, 2 channels and 16-bits per sample.
- (4) WMA Lossless, WMA Voice, WMA 10 Professional, and files which have DRM protection are not supported.
- (5) When using your soundbar as part of a group of multi-room products, audio files in ALAC and FLAC formats will only play on the group master.

Specifications

Power Requirements

| | |
|------------------------|-------------------------------|
| Mains | 100 - 240 volts AC, 50Hz/60Hz |
| Remote Control Battery | 2 x CR2032 |

Connectivity

| | |
|----------------|--|
| Wired Ethernet | 10/100M bits/sec via RJ-45 connector |
| WiFi | 802.11 b, g, n, a supported with WEP and WPA / WPA2 encryption |

Compatible with 2.4 GHz and 5 GHz WiFi bands

| | |
|----------------------------|-------------------|
| Bluetooth standards | A2DP, AVRCP |
| Bluetooth codecs supported | aptX, SBC and AAC |

Frequency Coverage

| | |
|-----|----------------------|
| FM | 87.5 - 108MHz |
| DAB | 174.928 - 239.200MHz |

Circuit features

| | |
|---------------------------|-------------------------|
| Optical digital input x 2 | 'Toslink' style sockets |
| Coaxial digital input | Phono socket |

| | |
|---------------------------|-----------------------------|
| Auxiliary Input | 3.5mm diameter, stereo |
| Line input socket | Phono sockets (Left, Right) |
| External subwoofer output | Phono socket |

| | | |
|---------------|--------|---------------------------------------|
| Aerial System | WiFi | Built-in antenna |
| | DAB/FM | Internal antenna |
| | DAB/FM | External antenna via F-type connector |

The company reserves the right to amend the specifications without notice.



If at any time in the future you should need to dispose of this product please note that: Waste electrical products should not be disposed of with household waste. Please recycle where facilities exist. Check with your Local Authority or retailer for recycling advice. (Waste Electrical and Electronic Equipment Directive)