



Operating Instructions

**HT-S3800** 5.1-Channel Home Theater System / 5.1-Channel Home Cinema System

**HT-R395** AV Receiver

**HTP-395** Speaker System

# Contents

Thank you for buying this Onkyo product. Please read through these operating instructions so you will know how to operate your model properly.

<b>Before you start</b> . . . . .	<b>3</b>
Checking what's in the box . . . . .	3
Installing the receiver . . . . .	3
<b>Flow of settings on the receiver</b> . . . . .	<b>3</b>
<b>1 Controls and displays</b>	
Front panel . . . . .	4
Display . . . . .	5
Remote control . . . . .	6
Loading the batteries . . . . .	7
Operating range of remote control . . . . .	7
<b>2 Connecting your equipment</b>	
Placing the speakers . . . . .	8
Affixing Non-Skid Pads . . . . .	8
Hints on the speaker placement . . . . .	8
Connecting the speakers . . . . .	9
Making cable connections . . . . .	10
HDMI cables . . . . .	10
About HDMI . . . . .	10
Analog audio cables . . . . .	11
Digital audio cables . . . . .	11
Standard RCA video cables . . . . .	11
About video outputs connection . . . . .	11
Connecting a TV and playback components . . . . .	12
Connecting using HDMI . . . . .	12
Connecting your component with no HDMI terminal . . . . .	13
Connecting antennas . . . . .	14
Using external antennas . . . . .	14
Connecting a USB device . . . . .	15
Plugging in the receiver . . . . .	15

<b>3 Basic playback</b>	
Playing a source . . . . .	16
Selecting the audio input signal . . . . .	16
Playing a USB device . . . . .	18
Basic playback controls . . . . .	18
Compressed audio compatibility . . . . .	18
Music playback using BLUETOOTH® wireless technology . . . . .	19
Pairing with the unit (Initial registration) . . . . .	19
Listen to music on the unit from a BLUETOOTH capable device . . . . .	19
Radio wave caution . . . . .	19
Listening to the radio . . . . .	20
Improving FM sound . . . . .	20
Saving station presets . . . . .	20
Listening to station presets . . . . .	21
Naming preset stations . . . . .	21
An introduction to RDS (For Europe) . . . . .	21
Searching for RDS programs . . . . .	21
Displaying RDS information . . . . .	22
<b>4 Listening to your system</b>	
Choosing the listening mode . . . . .	23
Listening in surround sound . . . . .	23
Playing back in the STEREO mode . . . . .	23
Using the DSP . . . . .	23
Using Direct . . . . .	23
Using the Music Optimizer . . . . .	24
Setting the Audio options . . . . .	24
Displaying the Fixed PCM Setting menu . . . . .	26
Changing the TV format setting of Graphical User Interface (Except for the U.S.A., Canada and Latin America models) . . . . .	26
Changing the frequency step of AM Radio (Except for the U.S.A., Canada and Latin America models) . . . . .	27

<b>5 Setup</b>	
Using the Setup . . . . .	28
Manual speaker setup . . . . .	28
Speaker Setting . . . . .	28
X.Over . . . . .	29
Channel Level . . . . .	29
Speaker Distance . . . . .	30
The Input Assign menu . . . . .	30
The Auto Power Down menu . . . . .	31
The HDMI Setup menu . . . . .	31
<b>6 Additional information</b>	
Troubleshooting . . . . .	33
General . . . . .	33
HDMI . . . . .	34
Important information regarding the HDMI connection . . . . .	34
USB messages . . . . .	34
About the Speaker System . . . . .	35
Precautions . . . . .	35
Effective Combination of Subwoofer and Front/Center/Surround speakers . . . . .	35
Operation . . . . .	35
Making amplifier settings . . . . .	35
Wall-mounting the Front/Center/Surround speaker system . . . . .	36
Resetting the main unit . . . . .	36
Cleaning the unit . . . . .	36
Specifications . . . . .	37
Software license notice . . . . .	39

## Before you start

### Checking what's in the box

Please check that you've received the following supplied accessories:

- Remote control
- AAA size IEC R03 dry cell batteries (to confirm system operation) x2
- AM loop antenna
- FM wire antenna
- Speaker cables (3 m/10 ft.) x2
- Speaker cables (8 m/26 ft.) x2
- Non-Skid Pads x20
- Quick start guide
- Safety Brochure

### Installing the receiver

- When installing this unit, make sure to put it on a level and stable surface.

Don't install it on the following places:

- on a color TV (the screen may distort)
- near a cassette deck (or close to a device that gives off a magnetic field). This may interfere with the sound.
- in direct sunlight
- in damp or wet areas
- in extremely hot or cold areas
- in places where there is vibration or other movement
- in places that are very dusty
- in places that have hot fumes or oils (such as a kitchen)

## Flow of settings on the receiver

The unit is a full-fledged AV receiver equipped with an abundance of functions and terminals. It can be used easily after following the procedure below to make the connections and settings.

*The colors of the steps indicate the following:*

### Required setting item

### Setting to be made as necessary

#### 1 Connecting the speakers

Where you place the speakers will have a big effect on the sound.

- Placing the speakers ([page 8](#))
- Connecting the speakers ([page 9](#))



#### 2 Connecting the components

For surround sound, you'll want to hook up using a digital connection from the Blu-ray Disc/DVD player to the receiver.

- About video outputs connection ([page 11](#))
- Connecting a TV and playback components ([page 12](#))
- Connecting antennas ([page 14](#))
- Plugging in the receiver ([page 15](#))



#### 3 Power On

Make sure you've set the video input on your TV to this receiver. Check the manual that came with the TV if you don't know how to do this.



#### 4 Making the initial settings according to the region and environment in which you live

- Changing the TV format setting of Graphical User Interface (Except for the U.S.A., Canada and Latin America models) ([page 26](#))
- Changing the frequency step of AM Radio (Except for the U.S.A., Canada and Latin America models) ([page 27](#))



#### 5 Specify the size and number of speakers you've connected

- Speaker Setting ([page 28](#))



#### 6 The Input Assign menu ([page 30](#))

*(When using connections other than the recommended connections.)*

**The HDMI Setup menu ([page 31](#))**

*(When the connected TV supports the HDMI Audio Return Channel function.)*



#### 7 Basic playback ([page 16](#))

- Selecting the audio input signal ([page 16](#))
- Playing a USB device ([page 18](#))
- Choosing the listening mode ([page 23](#))



#### 8 Adjusting the sound as desired

- Using the Music Optimizer ([page 24](#))
- Setting the Audio options ([page 24](#))
- Manual speaker setup ([page 28](#))

# 1: Controls and displays

## Front panel

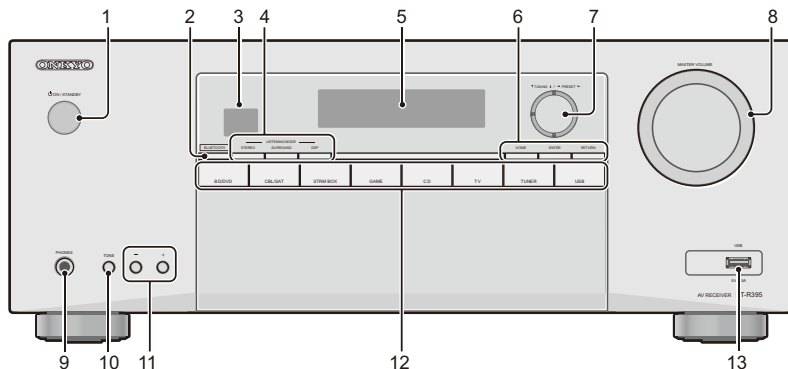

### 1 ON/STANDBY

### 2 BLUETOOTH

Switches to the BT Audio input

### 3 Remote sensor

Receives the signals from the remote control (see [Operating range of remote control on page 7](#)).

### 4 Listening mode buttons

**STEREO** – Switches to the STEREO mode ([page 23](#)).

**SURROUND** – Press for standard decoding and to switch between the modes of **Pro Logic II** and **NEO:6**.

**DSP** – Switches between the various surround modes ([page 23](#)).

### 5 Character display

See [Display on page 5](#).

### 6 HOME/ENTER/RETURN buttons

**HOME** – Use to access the Setup.

**ENTER** – Press to confirm the specified settings.

**RETURN** – Use to return to the display immediately previous when making settings

### 7 Tuner control/Cursor buttons

▼ **TUNING** ▲ – Used to find radio frequencies ([page 20](#)).

◀ **PRESET** ▶ – Use to select preset radio stations ([page 21](#)).

These are also used to move the cursors when displaying the Setup, for example.

### 8 MASTER VOLUME dial

### 9 PHONES jack

Use to connect headphones. When the headphones are connected, there is no sound output from the speakers.

### 10 TONE

Switches the display between **Bass** settings and **Treble** settings.

### 11 TONE +/-

Press to change the settings while the **Bass** or **Treble** settings are displayed.

### 12 INPUT SELECTOR buttons

Selects an input source ([page 16](#)).

### 13 USB terminal

Use to connect your USB mass storage device as an audio source ([page 15](#)).

## Display

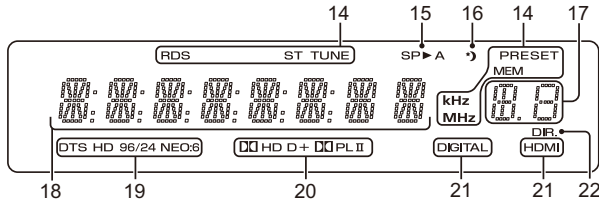

### 14 Tuner indicators

**RDS** – Lights when an RDS broadcast is received ([page 21](#)). (For Europe)

**ST** – Lights when a stereo FM broadcast is being received in auto stereo mode ([page 20](#)).

**TUNE** – Lights when a normal broadcast channel.

**PRESET** – Shows when a preset radio station is registered or called.

**MEM** – Blinks when a radio station is registered.

**kHz/MHz** – Lights when the character display is showing the currently received AM/FM broadcast frequency.

### 15 Speaker indicators

Shows if the speaker system is on or not.

**SP▶A** means the speaker system is on.

**SP▶** means the speaker system is off.

### 16 Sleep timer indicator

Lights when the receiver is in sleep mode ([page 6](#)).

### 17 PRESET information or input signal indicator

Shows the preset number of the tuner or the input signal type, etc.

### 18 Character display

Displays various system information.

### 19 DTS indicators

**DTS** – Lights when a source with DTS encoded audio signals is detected.

**HD** – Lights when a source with DTS-EXPRESS or DTS-HD encoded audio signals is detected.

**96/24** – Lights when a source with DTS 96/24 encoded audio signals is detected.

**NEO:6** – When one of the NEO:6 modes of the receiver is on, this lights to indicate NEO:6 processing ([page 23](#)).

### 20 Dolby Digital indicators

**D** – Lights when a Dolby Digital encoded signal is detected.

**D+** – Lights when a source with Dolby Digital Plus encoded audio signals is detected.

**HD** – Lights when a source with Dolby TrueHD encoded audio signals is detected.

**PLII** – Lights to indicate **D** Pro Logic II decoding (see [Listening in surround sound on page 23](#) for more on this).

### 21 SIGNAL SELECT indicators

**DIGITAL** – Lights when a digital audio signal is selected. Blinks when a digital audio signal is selected and selected audio input is not provided.

**HDMI** – Lights when an HDMI signal is selected. Blinks when an HDMI signal is selected and selected HDMI input is not provided.

### 22 DIR.

Lights when the **DIRECT** mode is switched on ([page 23](#)).

## Remote control

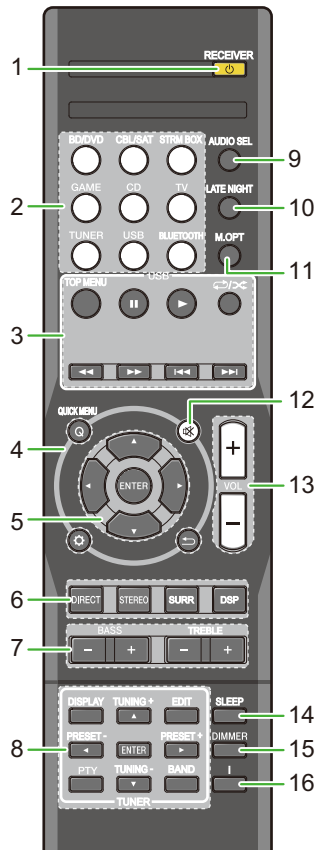

As for operating other devices, the remote control codes for the Onkyo products are preset. The settings cannot be changed.

### 1 RECEIVER

Switches the receiver between standby and on.

### 2 Input function buttons

Use to select the input source to this receiver ([page 16](#)). This will enable you to control other Onkyo components with the remote control.

### 3 USB control buttons

Use to control the **USB** source. Operations other than USB are not possible.

### 4 Receiver control buttons

**Q (QUICK MENU)** – Use to access the Audio options ([page 24](#)).

– Press to access the Setup ([page 28](#)).

– Use to return to the display immediately previous when making settings

### 5 ENTER

Use the arrow buttons when setting up your surround sound system ([page 28](#)).

### 6 Listening mode and component control buttons

**DIRECT** – Press to select Direct playback ([page 23](#)).

**STEREO** – Press to select stereo playback ([page 23](#)).

**SURR** – Press for standard decoding and to switch between the modes of Pro Logic II and NEO:6 ([page 23](#)).

**DSP** – Switches between the various surround modes ([page 23](#)).

### 7 BASS +/-, TREBLE +/-

Use to adjust Bass or Treble.

- These controls are disabled when the listening mode is set to **DIRECT**.

- When the front speaker is set at **SMALL** in the Speaker Setting and the X.Over is set above 150 Hz, the subwoofer channel level will be adjusted by pressing **BASS +/-** ([page 29](#)).

### 8 TUNER control buttons

See [Listening to the radio on page 20](#).

### 9 AUDIO SEL

Press to select the audio input signal of the component to play back ([page 16](#)).

### 10 LATE NIGHT

Turns ON and OFF the **LATE NIGHT** function ([page 24](#)).

### 11 M.OPT

Press to restore CD quality sound to compressed audio sources ([page 24](#)).

### 12

Mutes/unmutes the sound.

### 13 VOL +/-

Use to set the listening volume.

### 14 SLEEP

Press to change the amount of time before the receiver switches into standby (**30 min – 60 min – 90 min – Off**). You can check the remaining sleep time at any time by pressing **SLEEP** once.

### 15 DIMMER

Dims or brightens the display. The brightness can be controlled in four steps.

### 16 i

Switches the display of this unit. The listening mode, sound volume or input name can be checked by selecting an input source.

## Loading the batteries

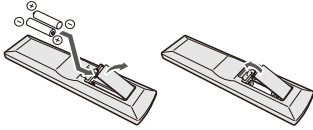

The batteries included with the unit are to check initial operations; they may not last over a long period. We recommend using alkaline batteries that have a longer life.

### ⚠ WARNING

- Do not use or store batteries in direct sunlight or other excessively hot place, such as inside a car or near a heater. This can cause batteries to leak, overheat, explode or catch fire. It can also reduce the life or performance of batteries.

### ⚠ CAUTION

- Incorrect use of batteries may result in such hazards as leakage and bursting. Observe the following precautions:
  - Never use new and old batteries together.
  - Insert the plus and minus sides of the batteries properly according to the marks in the battery case.
  - Batteries with the same shape may have different voltages. Do not use different batteries together.
  - When disposing of used batteries, please comply with governmental regulations or environmental public institution's rules that apply in your country/area.
  - When inserting the batteries, make sure not to damage the springs on the battery's (-) terminals. This can cause batteries to leak or overheat.

## Operating range of remote control

The remote control may not work properly if:

- There are obstacles between the remote control and the receiver's remote sensor.
- Direct sunlight or fluorescent light is shining onto the remote sensor.
- The receiver is located near a device that is emitting infrared rays.
- The receiver is operated simultaneously with another infrared remote control unit.

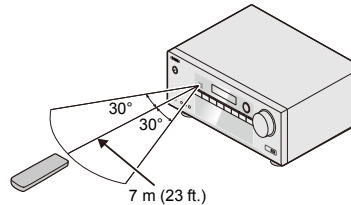

## 2: Connecting your equipment

### Placing the speakers

By connecting the left and right front speakers (L/R), the center speaker (C), the left and right surround speakers (SL/SR), and the subwoofer (SW), a 5.1 ch surround system can be enjoyed.

To achieve the best possible surround sound, install your speakers as shown below.

5.1 channel surround system:

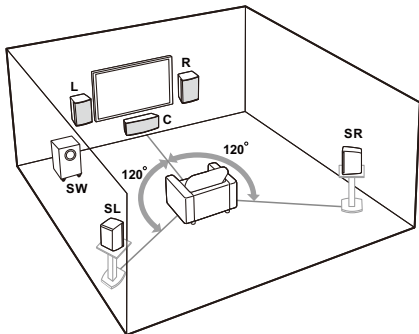

### Subwoofer

- Orient the subwoofer's front face pointing toward the listening position.
- When moving the subwoofer, avoid touching the bottom surface, since the speaker unit is located there.
- The subwoofer plays back the bass in monaural, making use of the fact that the human ear is not very sensitive to the direction of low-pitched sound. Because of this, the subwoofer can be installed almost anywhere. If it is installed too far away, however, the sound from the other speakers may become unnatural. The degree of bass effect can be adjusted by moving the unit farther from or closer to the wall.

### Front/Center/Surround speakers

- Labels located on the rear of each speaker indicate whether they are designed for front or surround use.
- Optional speaker stands can be purchased to facilitate optimal mounting of the surround speakers at or slightly above the listener's ear height.
- The surround effect will be diminished if the surround speakers are mounted at extreme distances from the listener's position.

### Affixing Non-Skid Pads

Apply the accessory non-skid pads to the bottom surfaces of the front/center/surround speakers

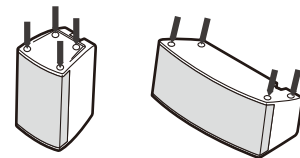

### Hints on the speaker placement

Where you put your speakers in the room has a big effect on the quality of the sound. The following guidelines should help you to get the best sound from your system.

- The subwoofer can be placed on the floor. Ideally, the other speakers should be at about ear-level when you're listening to them. Putting the speakers on the floor (except the subwoofer), or mounting them very high on a wall is not recommended.
- For the best stereo effect, place the front speakers 2 m to 3 m (6 ft. to 9 ft.) apart, at equal distance from the TV.
- If you're going to place speakers around your CRT TV, place the speakers at a sufficient distance from your CRT TV. Any other device liable to be influenced by magnetism (floppy disk drive, cassette tape recorder, video tape player, etc.) should also be kept at a distance from the subwoofer and other speakers.
- If you're using a center speaker, place the front speakers at a wider angle. If not, place them at a narrower angle.
- It is best to angle the speakers towards the listening position. The angle depends on the size of the room. Use less of an angle for bigger rooms.
- The optimal positioning for surround speakers is just above ear height. Make sure the speakers don't face each other. For DVD-Audio, the speakers should be more directly behind the listener than for home theater playback.
- Try not to place the surround speakers farther away from the listening position than the front and center speakers. Doing so can weaken the surround sound effect.

### CAUTION

- Make sure that all speakers are securely installed. This not only improves sound quality, but also reduces the risk of damage or injury resulting from speakers being knocked over or falling in the event of external shocks such as earthquakes.
- Install the center speaker below the TV so that the sound of the center channel is localized at the TV screen.
- Do not place the center speaker on top of the TV, the speaker may fall from the TV due to external shocks such as earthquakes, endangering those nearby or damaging the speaker.

## Connecting the speakers

The receiver will work with just two stereo speakers (the front speakers in the diagram) but using at least three speakers is recommended, and a complete setup is best for surround sound.

Make sure you connect the speaker on the right to the right (R) terminal and the speaker on the left to the left (L) terminal. Also make sure the positive and negative (+/−) terminals on the receiver match those on the speakers.

You can use speakers with a nominal impedance between 6 Ω and 16 Ω.

*Be sure to complete all connections before connecting this unit to the AC power source.*

### Bare wire connections

1 Twist exposed wire strands together.

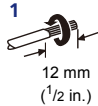

2 Push open the tabs and insert exposed wire.

3 Release the tabs.

### Note

- Connect the wire with the colored marker to the red (+) terminal; the plain wire to the black (−) terminal.

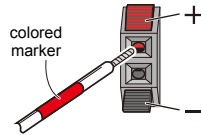

### CAUTION

- These speaker terminals carry **HAZARDOUS LIVE** voltage. To prevent the risk of electric shock when connecting or disconnecting the speaker cables, disconnect the power cord before touching any uninsulated parts.
- Make sure that all the bare speaker wire is twisted together and inserted fully into the speaker terminal. If any of the bare speaker wire touches the back panel it may cause the power to cut off as a safety measure.
- After connecting the plugs, pull lightly on the cables to make sure that the ends of the cables are securely connected to the terminals. Poor connections can create noise and interruptions in the sound.
- If the cables' wires happen to be pushed out of the terminals, allowing the wires to come into contact with each other, it places an excessive additional load on the receiver. This may cause the amp to stop functioning, and may even damage the receiver.
- When using a set of speakers connected to an receiver, you won't be able to obtain the normal stereo effect if the polarity (+, −) of one of the speakers (left or right) is reversed.

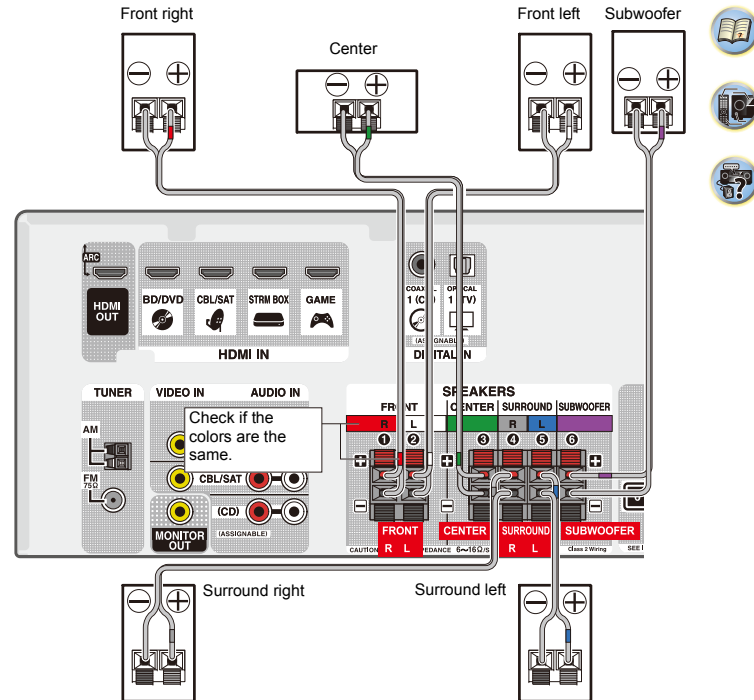

## Making cable connections

Make sure not to bend the cables over the top of this unit (as shown in the illustration). If this happens, the magnetic field produced by the transformers in this unit may cause a humming noise from the speakers.

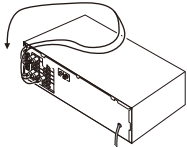

### Important

- Before making or changing connections, switch off the power and disconnect the power cord from the AC outlet.
- Before unplugging the power cord, switch the power into standby.

## HDMI cables

Both video and sound signals can be transmitted simultaneously with one cable. If connecting the player and the TV via this receiver, for both connections, use HDMI cables.

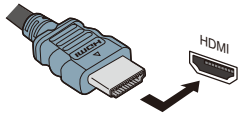

Be careful to connect the terminal in the proper direction.

### Note

- Set the HDMI parameter in [Setting the Audio options on page 24](#) to **THRU** (THROUGH) and set the input signal in [Selecting the audio input signal on page 16](#) to **HDMI**, if you want to hear HDMI audio output from your TV (no sound will be heard from this receiver).

- If the video signal does not appear on your TV, try adjusting the resolution settings on your component or display. Note that some components (such as video game units) have resolutions that may not be displayed. In this case, use a (analog) composite connection.
- When the video signal from the HDMI is 480i, 480p, 576i or 576p, Multi Ch PCM sound and HD sound cannot be received.

## About HDMI

The HDMI connection transfers uncompressed digital video, as well as almost every kind of digital audio that the connected component is compatible with, including DVD-Video, DVD-Audio, SACD, Dolby Digital Plus, Dolby TrueHD, DTS-HD Master Audio (see below for limitations), Video CD/Super VCD and CD.

This receiver incorporates High-Definition Multimedia Interface (HDMI<sup>®</sup>) technology.

This receiver supports the functions described below through HDMI connections.

- Digital transfer of uncompressed video (contents protected by HDCP (1080p/24, 1080p/60, etc.))
- 3D signal transfer
- Deep Color signal transfer
- x.v.Color signal transfer
- Audio Return Channel (see [The HDMI Setup menu on page 31](#))
- Input of multi-channel linear PCM digital audio signals (192 kHz or less) for up to 8 channels
- Input of the following digital audio formats:
  - Dolby Digital, Dolby Digital Plus, DTS, High bitrate audio (Dolby TrueHD, DTS-HD Master Audio), DVD-Audio, CD, SACD (DSD 2 ch only), Video CD, Super VCD
- 4K signal transfer
  - This may not operate properly, depending on the connected equipment.
  - 4K 24p, 4K 25p, 4K 30p, 4K 50p and 4K 60p signals are supported.
- HDCP 2.2 compatible terminal

### Note

- Use a High Speed HDMI<sup>®/™</sup> Cable. If HDMI cable other than a High Speed HDMI<sup>®/™</sup> Cable is used, it may not work properly.
- When an HDMI cable with a built-in equalizer is connected, it may not operate properly.
- 3D, Deep Color, x.v.Color, 4K signal transfer and Audio Return Channel are only possible when connected to a compatible component.
- HDMI format digital audio transmissions require a longer time to be recognized. Due to this, interruption in the audio may occur when switching between audio formats or beginning playback.
- Turning on/off the device connected to this unit's HDMI OUT terminal during playback, or disconnecting/connecting the HDMI cable during playback, may cause noise or interrupted audio.

**HDMI**<sup>®</sup>  
HIGH-DEFINITION MULTIMEDIA INTERFACE

*The terms HDMI and HDMI High-Definition Multimedia Interface, and the HDMI Logo are trademarks or registered trademarks of HDMI Licensing, LLC in the United States and other countries.*

*"x.v.Color" and x.v.Color are trademarks of Sony Corporation.*

### Analog audio cables

Use stereo RCA phono cables to connect analog audio components. These cables are typically red and white, and you should connect the red plugs to R (right) terminals and white plugs to L (left) terminals.

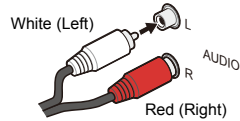

### Digital audio cables

Commercially available coaxial digital audio cables or optical cables should be used to connect digital components to this receiver.

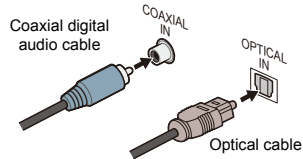

#### Note

- When connecting optical cables, be careful when inserting the plug not to damage the shutter protecting the optical socket.
- When storing optical cable, coil loosely. The cable may be damaged if bent around sharp corners.
- You can also use a standard RCA video cable for coaxial digital connections.

### Standard RCA video cables

These cables are the most common type of video connection and are used to connect to the composite video terminals. The yellow plugs distinguish them from cables for audio.



### About video outputs connection

This receiver is not loaded with a video converter. When you use HDMI cables for connecting to the input device, the same cables should be used for connecting to the TV. The signals input from the analog (composite) video inputs of this unit will not be output from the **HDMI OUT**.

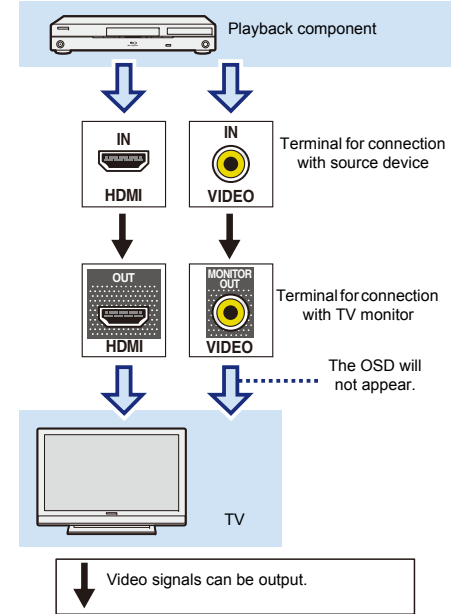

## Connecting a TV and playback components

### Connecting using HDMI

If you have an HDMI or DVI (with HDCP) equipped component (Blu-ray Disc player, etc.), you can connect it to this receiver using a commercially available HDMI cable.

- The following connection/setting is required to listen to the sound of the TV over this receiver.
  - If the TV does not support the HDMI Audio Return Channel function, connect the receiver and TV with audio cables (as shown).
  - If the TV supports the HDMI Audio Return Channel function, the sound of the TV is input to the receiver via the HDMI terminal, so there is no need to connect an audio cable. In this case, set **ARC at HDMI Setup to ON** (see [The HDMI Setup menu on page 31](#)).
  - Please refer to the TV's operation manual for directions on connections and setup for the TV.

### Important

- When the ARC function is **ON** and the receiver is connected to a compatible TV with an HDMI cable, and you switch the input of the TV to composite, the input of the receiver may automatically switch to **TV**. If this happens, switch the receiver's input back to the original input, or turn **OFF** the ARC function (see [The HDMI Setup menu on page 31](#)).

### Note

- In order to listen to the audio from the TV that is connected to this receiver using an analog audio cables, set-up for analog audio input is required (see [The Input Assign menu on page 30](#)).

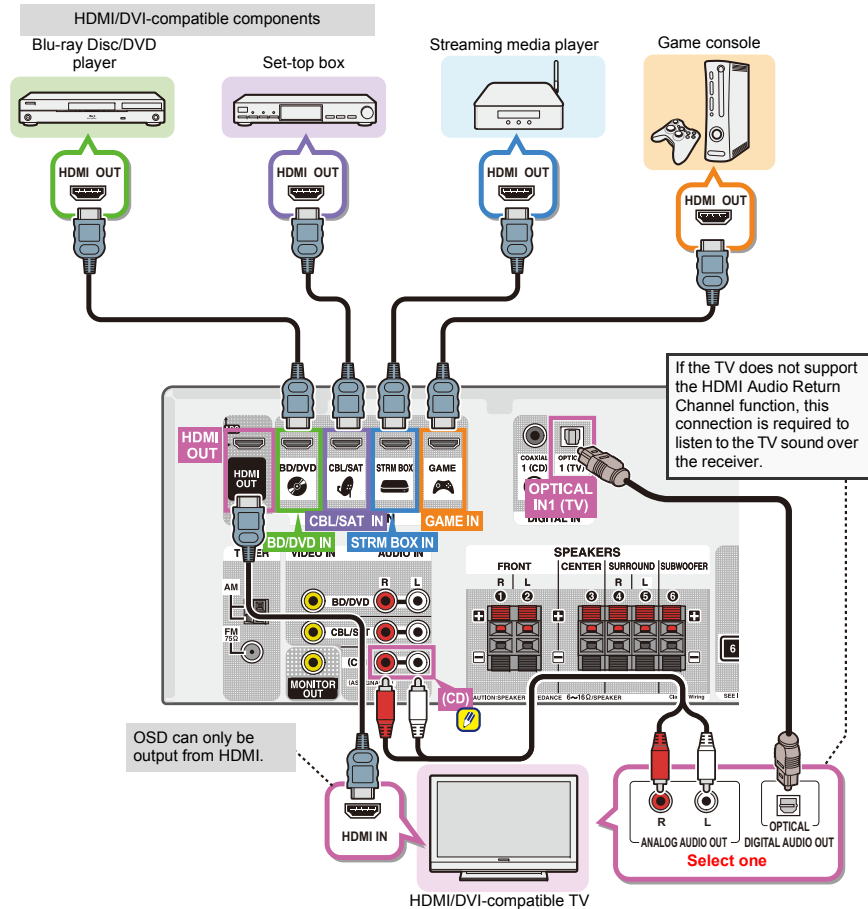

## Connecting your component with no HDMI terminal

This diagram shows connections of a TV and Blu-ray Disc/DVD player (or other playback component) with no HDMI terminal to the receiver.

### Important

- When the receiver and TV are connected by composite cable, the OSD function allowing display of the receiver's settings, operations, etc., on the TV's screen cannot be used. In this case, watch the receiver's front panel display while performing the various operations and making settings.

### Note

- You can only connect one component to the optical input terminal. If connecting other devices, please use a different method to connect the audio.

In order to listen to the audio from the source component that is connected to this receiver using an optical cable, first, switch to the **BD/DVD** (Blu-ray Disc/DVD player) or **CBL/SAT** (set-top box), then press **AUDIO SEL** to choose the audio signal **O1** (OPTICAL1) (see [Selecting the audio input signal on page 16](#)).

- You can only connect one component to the coaxial input terminal. If connecting other devices, please use a different method to connect the audio.

In order to listen to the audio from the source component that is connected to this receiver using a coaxial cable, first, switch to the **BD/DVD** (Blu-ray Disc/DVD player) or **CBL/SAT** (set-top box), then press **AUDIO SEL** to choose the audio signal **C1** (COAXIAL1) (see [Selecting the audio input signal on page 16](#)).

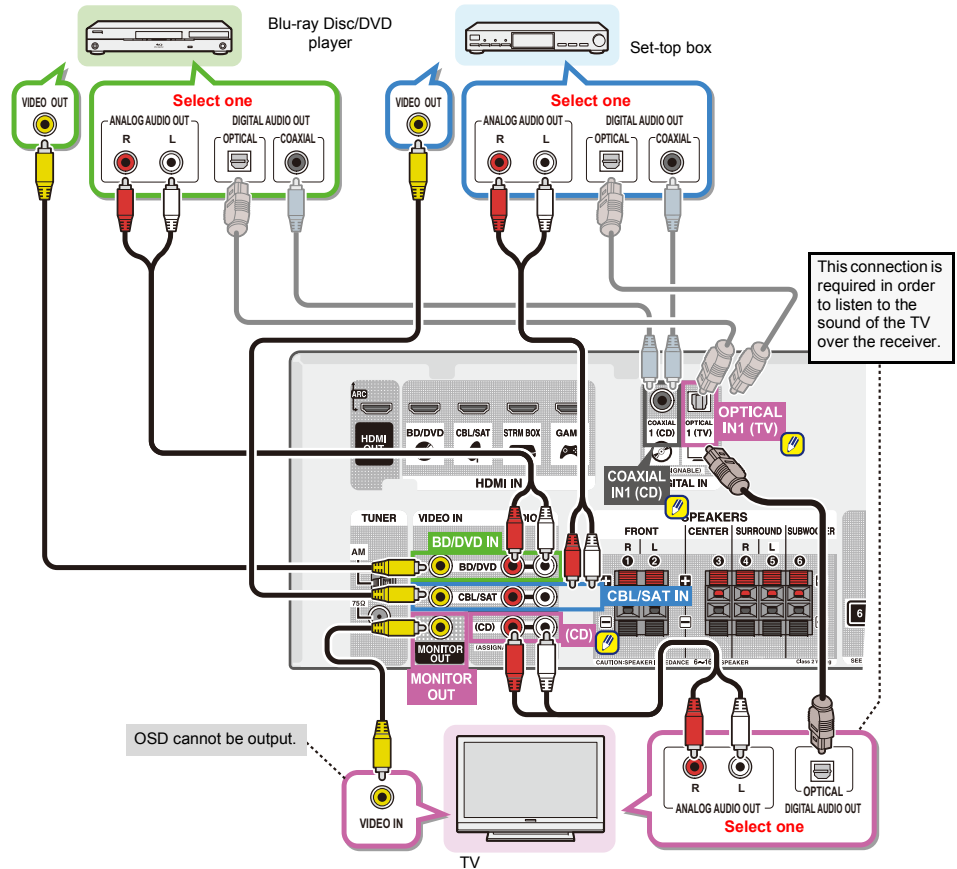

## Connecting antennas

Connect the AM loop antenna and the FM wire antenna as shown below. To improve reception and sound quality, connect external antennas (see [Using external antennas below](#)).

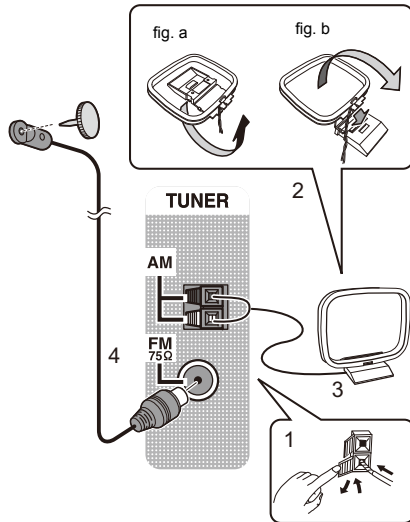

**1** Push open the tabs, then insert one wire fully into each terminal, then release the tabs to secure the AM antenna wires.

**2** Fix the AM loop antenna to the attached stand. To fix the stand to the antenna, bend in the direction indicated by the arrow (fig. a) then clip the loop onto the stand (fig. b).

**3** Place the AM antenna on a flat surface and in a direction giving the best reception.

**4** Connect the FM wire antenna into the FM antenna socket.

For best results, extend the FM antenna fully and fix to a wall or door frame. Don't drape loosely or leave coiled up.

## Using external antennas

### To improve FM reception

**(For the U.S.A., Canada and Latin America models)**  
Use an F connector (no screw type) (not supplied) to connect an external FM antenna.

**(For the other models)**  
Use a PAL connector (not supplied) to connect an external FM antenna.

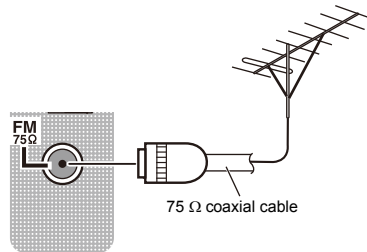

### To improve AM reception

Connect a 5 m to 6 m (16 ft. to 20 ft.) length of vinyl-coated wire to the AM antenna terminal without disconnecting the supplied AM loop antenna.

For the best possible reception, suspend horizontally outdoors.

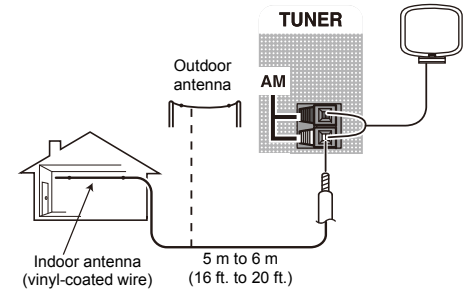



# 3: Basic playback

## Playing a source

Here are the basic instructions for playing a source (such as a DVD disc) with your home theater system.

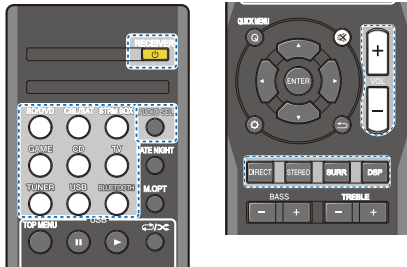

### 1 Switch on your system components and receiver.

Start by switching on the playback component (for example a DVD player) and your TV, then the receiver (press **RECEIVER**).

### 2 Switch the TV input to the input that connects this receiver.

For example, if you connected this receiver to the **VIDEO** jacks on your TV, make sure that the **VIDEO** input is now selected.

### 3 Press input function buttons to select the input function you want to play.

If you selected the proper input source and there is still no sound, select the audio input signal for playback (see [Selecting the audio input signal below](#)).

### 4 Press the **DIRECT** button.

Change the listening mode as necessary.

It is possible to check on the front panel display whether or not surround sound playback is being performed properly.

If the display does not correspond to the input signal and listening mode, check the connections and settings.

## Note

- You may need to check the digital audio output settings on your DVD player or digital satellite receiver. It should be set to output Dolby Digital, DTS and 88.2 kHz/96 kHz PCM (2 channel) audio, and if there is an MPEG audio option, set this to convert the MPEG audio to PCM.
- Depending on your DVD player or source discs, you may only get digital 2 channel stereo and analog sound. In this case, the receiver must be set to a multichannel listening mode if you want multichannel surround sound.

## 5 Use **VOL +/-** to adjust the volume level.

Turn down the volume of your TV so that all sound is coming from the speakers connected to this receiver.

## Selecting the audio input signal

The audio input signal can be selected for each input source. Once it is set, the audio input that was selected will be applied whenever you select the input source using the input function buttons.

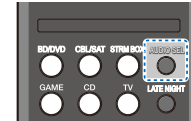

### Press **AUDIO SEL** to select the audio input signal corresponding to the source component.

Each press cycles through the following:

- H** – Selects an HDMI signal. **H** can be selected for **BD/DVD**, **CBL/SAT**, **STRM BOX** or **GAME** input. For other inputs, **H** cannot be selected.
  - When the **HDMI** option in [Setting the Audio options on page 24](#) is set to **THRU**, the sound will be heard through your TV, not from this receiver.
- A** – Selects the analog inputs.
- C1/O1** – Selects the digital input. The coaxial 1 input is selected for **C1**, and the optical 1 audio input is selected for **O1**.

When **H** (HDMI) or **C1/O1** (digital) is selected and the selected audio input is not provided, **A** (analog) is automatically selected.

## Note

- STRM BOX** and **GAME** inputs are fixed to **H** (HDMI). It cannot be changed.
- For the **TV** input, only **A** (analog) or **C1/O1** (digital) can be selected. However, if the **ARC** at **HDMI Setup** is set to **ON**, the input is fixed to **H** (HDMI) and cannot be changed.
- When set to **H** (HDMI) or **C1/O1** (digital), **HD** lights when a Dolby Digital signal is input, and **DTS** lights when a DTS signal is input.
- When the **H** (HDMI) is selected, the **A** and **DIGITAL** indicators are off (see [page 5](#)).

- When digital input (optical or coaxial) is selected, this receiver can only play back Dolby Digital, PCM (32 kHz to 96 kHz) and DTS (including DTS 96 kHz/24 bit) digital signal formats. The compatible signals via the HDMI terminals are: Dolby Digital, DTS, SACD (DSD 2 ch only), PCM (32 kHz to 192 kHz sampling frequencies), Dolby TrueHD, Dolby Digital Plus, DTS-EXPRESS, DTS-HD Master Audio and DVD Audio (including 192 kHz). With other digital signal formats, set to **A** (analog).
- You may get digital noise when a LD or CD player compatible with DTS is playing an analog signal. To prevent noise, make the proper digital connections ([page 11](#)) and set the signal input to **C1/O1** (digital).
- Some DVD players don't output DTS signals. For more details, refer to the instruction manual supplied with your DVD player.

Input function	Input Terminals			
	HDMI	COAXIAL	OPTICAL	ANALOG
BD/DVD	✓	✓	✓	✓
TV	✗ <sup>a</sup>	✓	✓	✗ <sup>b</sup>
CBL/SAT	✓	✓	✓	✓
CD	✗	✓	✓	✓
STRM BOX	✓	✗	✗	✗
GAME	✓	✗	✗	✗

- a. The HDMI terminals can be used for the TV input by turning ON the ARC function in the HDMI setting ([page 31](#)).
- b. In order to listen to the audio from the TV that is connected to this receiver using an analog audio cables, set-up for analog audio input is required (see [The Input Assign menu on page 30](#)).

**Tip**

- In order to enjoy the picture and/or sound from devices connected to each terminal, select the input by doing the following.

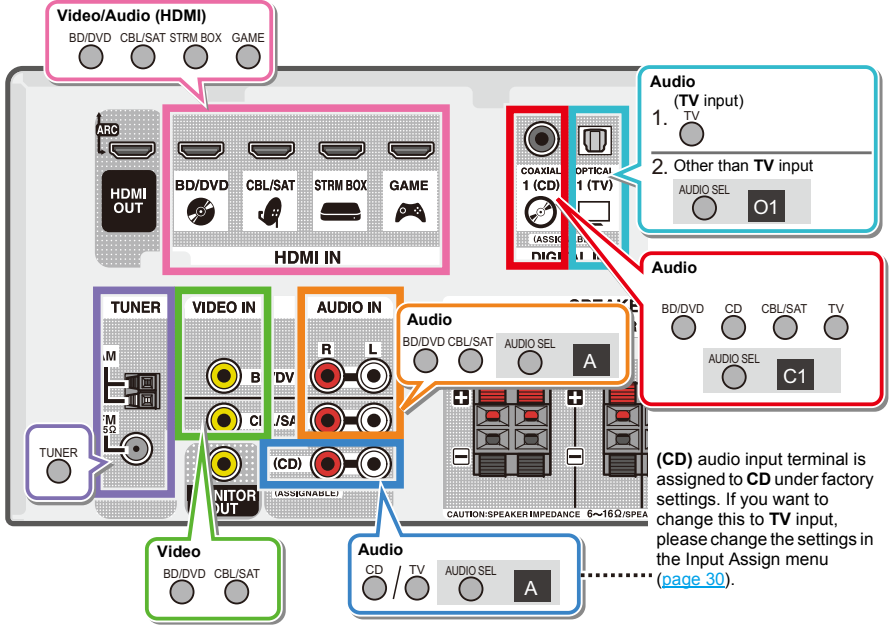

**Video/Audio (HDMI)**  
BD/DVD CBL/SAT STRM BOX GAME

**Audio (TV input)**  
1. TV  
2. Other than TV input  
AUDIO SEL O1

**Audio**  
BD/DVD CD CBL/SAT TV  
AUDIO SEL C1

**Audio**  
BD/DVD CBL/SAT TV  
AUDIO SEL A

**Video**  
BD/DVD CBL/SAT

**Audio**  
CD TV  
AUDIO SEL A

(CD) audio input terminal is assigned to CD under factory settings. If you want to change this to TV input, please change the settings in the Input Assign menu ([page 30](#)).

## Playing a USB device

It is possible to listen to two-channel audio using the USB interface on the front of this receiver.

### Important

- Onkyo cannot guarantee compatibility (operation and/or bus power) with all USB mass storage devices and assumes no responsibility for any loss of data that may occur when connected to this receiver.

### Note

- This includes playback of WMA/MP3/MPEG-4 AAC files (except files with copy-protection or restricted playback).
- Compatible USB devices include external magnetic hard drives, portable flash memory (particularly keydrives) and digital audio players (MP3 players) of format FAT16/32. It is not possible to connect this receiver to a computer for USB playback.
- With large amounts of data, it may take longer for the receiver to read the contents of a USB device.
- If the file selected cannot be played back, this receiver automatically skips to the next file playable.
- When the file currently being played back has no title assigned to it, the file name is displayed in the OSD instead; when neither the album name nor the artist name is present, the row is displayed as a blank space.
- Note that non-roman characters in the playlist are displayed as '\*'.
- Make sure the receiver is in standby when disconnecting the USB device.

## 1 Switch on the receiver and your TV.

See [Connecting a USB device on page 15](#).

## 2 Switch the TV input so that it connects to the receiver.

- Switch the TV input to the input that connects this receiver to the TV through the corresponding HDMI cable.

## 3 Press **USB** on the remote control to switch the receiver to the USB input.

**Loading** appears in the OSD as this receiver starts recognizing the USB device connected. After the recognition, a playback screen appears in the OSD and playback starts automatically.

## Basic playback controls

This receiver's remote control buttons can be used for basic playback of files stored on USB devices.

- Press **USB** to switch the remote control to the USB operation mode.

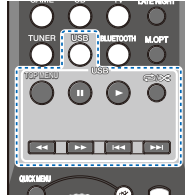

### Important

If a **USB Error** message lights in the display, try following the points below:

- Switch the receiver off, then on again.
- Reconnect the USB device with the receiver switched off.
- Select another input source (like **BD/DVD**), then switch back to **USB**.
- Use a dedicated AC adapter (supplied with the device) for USB power.

For more information on error messages, see [USB messages on page 34](#).

If this doesn't remedy the problem, it is likely your USB device is incompatible.

## Compressed audio compatibility

Note that although most standard bit/sampling rate combinations for compressed audio are compatible, some irregularly encoded files may not play back. The list below shows compatible formats for compressed audio files:

- MP3** (MPEG-1/2/2.5 Audio Layer 3) – Sampling rates: 32 kHz/44.1 kHz/48 kHz; Bit rates: 32 kbps to 320 kbps (128 kbps or higher recommended); File extension: **.mp3**
- WMA** (Windows Media Audio) – Sampling rates: 32 kHz/44.1 kHz/48 kHz; Bit rates: 48 kbps to 192 kbps (128 kbps or higher recommended); File extension: **.wma**; WMA9 Pro and WMA lossless encoding: No
- AAC** (MPEG-4 Advanced Audio Coding) – Sampling rates: 32 kHz/44.1 kHz/48 kHz; Bit rates: 16 kbps to 320 kbps (128 kbps or higher recommended); File extension: **.m4a**; Apple lossless encoding: No

## Other compatibility information

- VBR (variable bit rate) MP3/WMA/MPEG-4 AAC playback: Yes (Note that in some cases playback time will not be displayed correctly.)
- Copyrighted audio files cannot be played back on this receiver.
- DRM-protected audio files cannot be played back on this receiver.

## About MPEG-4 AAC

Advanced Audio Coding (AAC) is at the core of the MPEG-4 AAC standard, which incorporates MPEG-2 AAC, forming the basis of the MPEG-4 audio compression technology. The file format and extension used depend on the application used to encode the AAC file. This receiver plays back AAC files encoded by iTunes® bearing the extension '**.m4a**'. DRM-protected files will not play, and files encoded with some versions of iTunes® may not play.

*Apple and iTunes are trademarks of Apple Inc., registered in the U.S. and other countries.*

## About WMA

WMA is an acronym for Windows Media Audio and refers to an audio compression technology developed by Microsoft Corporation. This receiver plays back WMA files encoded using Windows Media® Player bearing the extension '**.wma**'. Note that DRM-protected files will not play, and files encoded with some versions of Windows Media® Player may not play.

## Music playback using BLUETOOTH® wireless technology

You can wirelessly enjoy music files stored in a smartphone or other BLUETOOTH capable device. The coverage area is about 33 feet (10 meters).

### Note

- The BLUETOOTH® word mark and logos are registered trademarks owned by Bluetooth SIG, Inc. and any use of such marks by Onkyo & Pioneer Corporation is under license. Other trademarks and trade names are those of their respective owners.
- The BLUETOOTH wireless technology enabled device must support A2DP profiles.
- We do not guarantee proper connection and operation of this unit with all BLUETOOTH wireless technology enabled devices.

### Pairing with the unit (Initial registration)

Pairing should be performed when first using the unit with the BLUETOOTH capable device, or when the pairing data on the device has been erased for any reason.

- After pressing the **BLUETOOTH** and switching to **BT Audio** function, perform the pairing procedure on the BLUETOOTH capable device. If pairing has been performed correctly, you will not need to perform the pairing procedures for the unit as shown below.



- 1 Press the **BLUETOOTH**.
- 2 Turn on the power to the **BLUETOOTH** capable device that you wish to pair with, and perform pairing procedure on it.

- This unit will be displayed as "Onkyo AV Receiver" on all BLUETOOTH capable devices that you have.

Pairing will start.

- Place the BLUETOOTH capable device close to the unit.
- Please refer to the user's manual for your BLUETOOTH capable device for details on when pairing can be performed and the procedures required for pairing.
- When PIN code entry is requested, enter "0000". (This unit does not accept any PIN code setting other than "0000".)

- 3 Confirm on the **BLUETOOTH** capable device that pairing has been completed.

If pairing with the BLUETOOTH capable device has been completed correctly "CONNECT" will be displayed.

### Listen to music on the unit from a BLUETOOTH capable device

- 1 Press the **BLUETOOTH**.

The unit will switch to **BT Audio** input.

- 2 A **BLUETOOTH** connection will be created between the **BLUETOOTH** capable device and the unit.

Procedures for connecting to the unit should be performed from the BLUETOOTH capable device.

- Please refer to the user's manual for your BLUETOOTH capable device for details of the connection procedures.

- 3 Playback music from the **BLUETOOTH** capable device.

### Radio wave caution

This unit uses a 2.4 GHz radio wave frequency, which is a band used by other wireless systems (see list below). To prevent noise or interrupted communication, do not use this unit nearby such devices, or make sure these devices are switched off during use.

- Cordless phones
- Cordless facsimiles
- Microwave ovens
- Wireless LAN devices (IEEE802.11b/g)
- Wireless AV equipment
- Wireless controllers for game systems
- Microwave-based health aids
- Some baby monitors

Other, less common, equipment that may operate on the same frequency:

- Anti-theft systems
- Amateur radio stations (HAM)
- Warehouse logistic management systems
- Discrimination systems for train or emergency vehicles

### Note

- In the event noise appears in your television image, there is the possibility that a BLUETOOTH wireless technology enabled device or this unit (including products supported by this unit) are causing signal interference with the antenna input connector of your television, video, satellite tuner, etc. In this event, increase the distance between the antenna input connector and the BLUETOOTH wireless technology enabled device or this unit (including products supported by this unit).
- If there is something obstructing the path between this unit (including devices supported by this unit) and the device equipped with BLUETOOTH wireless technology (such as a metal door, concrete wall, or insulation containing tinfoil), you may need to change the location of your system to prevent signal noise and interruptions.

### Scope of operation

Use of this unit is limited to home use. (Transmission distances may be reduced depending on communication environment).

In the following locations, poor condition or inability to receive radio waves may cause the audio to be interrupted or stopped:

- In reinforced concrete buildings or steel framed or iron-framed buildings.
- Near large metallic furniture.
- In a crowd of people or near a building or obstacle.
- In a location exposed to the magnetic field, static electricity or radio wave interference from radio communication equipment using the same frequency band (2.4 GHz) as this unit, such as a 2.4 GHz wireless LAN device (IEEE802.11b/g) or microwave oven.
- If you live in a heavily populated residential area (apartment, townhouse, etc.) and if your neighbor's microwave is placed near your system, you may experience radio wave interference. If this occurs, move your unit to a different place. When the microwave is not in use, there will be no radio wave interference.

### Radio wave reflections

The radio waves received by this unit include the radio wave coming directly from the device equipped with BLUETOOTH wireless technology (direct wave) and waves coming from various directions due to reflections by walls, furniture and building (reflected waves). The reflected waves (due to obstacles and reflecting objects) further produce a variety of reflected waves as well as variation in reception condition depending on locations. If the audio cannot be received properly due to this phenomenon, try moving the location of the device equipped with BLUETOOTH wireless technology a little. Also note that audio may be interrupted due to the reflected waves when a person crosses or approaches the space between this unit and the device equipped with BLUETOOTH wireless technology.

### Precautions regarding connections to products supported by this unit

- Complete connections for all devices supported by this unit, including all audio cords and power cables before connecting them to this unit.
- After completing connections to this unit, check the audio and power cables to confirm that they not twisted together.
- When disconnecting this unit, confirm that you have sufficient working space in the surrounding area.

When changing connections of audio or other cables for products supported by this unit, confirm that you have sufficient working space in the surrounding area.

### Listening to the radio

The following steps show you how to tune in to FM and AM radio broadcasts using the automatic (search) and manual (step) tuning functions. Once you are tuned to a station you can memorize the frequency for recall later—see [Saving station presets below](#) for more on how to do this.

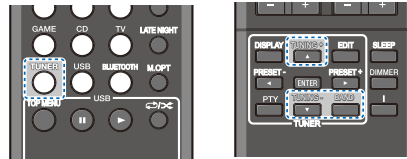

#### 1 Press **TUNER** to select the tuner.

#### 2 Use **BAND** to change the band (FM or AM), if necessary.

Each press switches the band between FM (stereo or mono) and AM.

#### 3 Tune to a station.

There are three ways to do this:

##### ◆Automatic tuning

To search for stations in the currently selected band, press and hold **TUNING +/-** for about a second. The receiver will start searching for the next station, stopping when it has found one. Repeat to search for other stations.

##### ◆Manual tuning

To change the frequency one step at a time, press **TUNING +/-**.

##### ◆High speed tuning

Press and hold **TUNING +/-** for high speed tuning.

### Improving FM sound

If the **TUNE** or **ST** indicators don't light when tuning to an FM station because the signal is weak, set the receiver to the mono reception mode.

#### ▶ Press **BAND** to select **FM MONO**.

This should improve the sound quality and allow you to enjoy the broadcast.

### Saving station presets

If you often listen to a particular radio station, it's convenient to have the receiver store the frequency for easy recall whenever you want to listen to that station. This saves the effort of manually tuning in each time. This unit can memorize up to 30 stations.

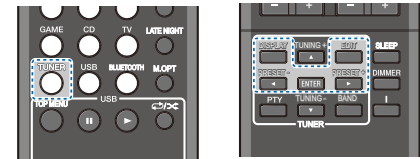

#### 1 Tune to a station you want to memorize.

See [Listening to the radio above](#) for more on this.

#### 2 Press **EDIT**.

The display shows **PRESET**, then a blinking **MEM** and station preset.

#### 3 Press **PRESET +/-** to select the station preset you want.

#### 4 Press **ENTER**.

The preset number stop blinking and the receiver stores the station.

#### 🔗 **Note**

- If the receiver is left disconnected from the AC power outlet for over a month, the station memories will be lost and will have to be reprogrammed.
- Stations are stored in stereo. When the station is stored in the FM MONO mode, it shows as **ST** when recalled.

### Listening to station presets

You will need to have some presets stored to do this. See [Saving station presets on page 20](#) if you haven't done this already.

- Press **PRESET +/-** to select the station preset you want.

### Naming preset stations

For easier identification, you can name all of your preset stations.

- Choose the station preset you want to name.  
See [Listening to station presets above](#) for how to do this.
  - Press **EDIT** twice.  
The cursor at the first character position is blinking on the display.
  - Input the name you want.  
Choose a name up to eight characters long.
    - Use **PRESET +/-** to select character position.
    - Use **TUNING +/-** to select characters.
    - The name is stored when **ENTER** is pressed.
- Tip**
- To erase a station name, follow steps 1 and 2, and press **ENTER** while the display is blank. Press **EDIT** while the display is blank, to keep the previous name.
  - Once you have named a station preset, Press **DISPLAY** to show the name. When you want to return to the frequency display, press **DISPLAY** several times to show the frequency.

### An introduction to RDS (For Europe)

Radio Data System (RDS) is a system used by most FM radio stations to provide listeners with various kinds of information—the name of the station and the kind of show they're broadcasting, for example.

One feature of RDS is that you can search by type of program. For example, you can search for a station that's broadcasting a show with the program type, **JAZZ**.

You can search the following program types:

**NEWS** – News  
**AFFAIRS** – Current Affairs  
**INFO** – General Information  
**SPORT** – Sport  
**EDUCATE** – Educational  
**DRAMA** – Radio plays, etc.  
**CULTURE** – National or regional culture, theater, etc.  
**SCIENCE** – Science and technology  
**VARIED** – Usually talk-based material, such as quiz shows or interviews.  
**POP M** – Pop music  
**ROCK M** – Rock music  
**EASY M** – Easy listening  
**LIGHT M** – 'Light' classical music  
**CLASSICS** – 'Serious' classical music  
**OTHER M** – Music not fitting above categories  
**WEATHER** – Weather reports

**FINANCE** – Stock market reports, commerce, trading, etc.  
**CHILDREN** – Programs for children  
**SOCIAL** – Social affairs  
**RELIGION** – Programs concerning religion  
**PHONE IN** – Public expressing their views by phone  
**TRAVEL** – Holiday-type travel rather than traffic announcements  
**LEISURE** – Leisure interests and hobbies  
**JAZZ** – Jazz  
**COUNTRY** – Country music  
**NATION M** – Popular music in a language other than English  
**OLDIES** – Popular music from the '50s and '60s  
**FOLK M** – Folk music  
**DOCUMENT** – Documentary

### Note

- In addition, there are three other program types, **ALARM**, **ALARMTST**, and **NO TYPE**. **ALARM** and **ALARMTST** are used for emergency announcements. **NO TYPE** appears when a program type cannot be found.

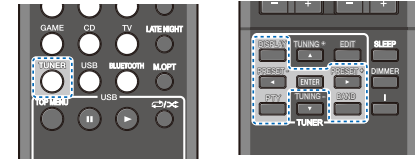

### Searching for RDS programs

You can search for a program type listed above.

- Press **TUNER** then press **BAND** to select the FM band.
  - RDS is only possible in the FM band.
- Press **PTY**.  
**SEARCH** shows in the display.
- Press **PRESET +/-** to select the program type you want to hear.
- Press **ENTER** to search for the program type.  
The system starts searching through the station presets for a match, stopping when it was found one. Repeat to search for other stations.  
If **NO PTY** is displayed it means the tuner couldn't find that program type at the time of the search.  
RDS searches station presets only. If no stations have been preset, or if the program type could not be found among the station presets **NO PTY** is displayed.  
**FINISH** means the search is complete.

### Displaying RDS information

Use the **DISPLAY** button to display the different types of RDS information available.

#### ▶ Press **DISPLAY** for RDS information.

Each press changes the display as follows:

- Listening mode
- Master volume
- Radio Text (**RT**) – Messages sent by the radio station.  
For example, a talk radio station may provide a phone number as RT.
- Program Service Name (**PS**) – The name of the radio station.
- Program Type (**PTY**) – This indicates the kind of program currently being broadcast.
- Current tuner frequency (**FREQ**)

#### **Note**

- If any noise is picked up while displaying the RT scroll, some characters may be displayed incorrectly.
- If you see **NO TEXT** in the RT display, it means no RT data is sent from the broadcast station. The display will automatically switch to the PS data display (if no PS data, **NO NAME** is displayed).
- In the PTY display, **NO PTY** may be shown.



# 4: Listening to your system

## Choosing the listening mode

This receiver offers a variety of listening modes to accommodate playback of various audio formats. Choose one according to your speaker environment or the source.

While listening to a source, press the listening mode button repeatedly to select a listening mode you want.

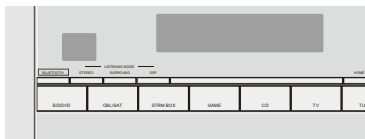
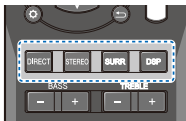

- The listening mode is shown on the display on the front panel.

### Important

- The listening modes and many features described in this section may not be available depending on the current source, settings and status of the receiver.

## Listening in surround sound



Using this receiver, you can listen to any source in surround sound. However, the options available will depend on your speaker setup and the type of source you're listening to.

- If the source is Dolby Digital, DTS, or Dolby Surround encoded, the proper decoding format will automatically be selected and shows in the display.

The following modes provide basic surround sound for stereo and multichannel sources.

Type of surround modes	Suitable sources
<b>Two channel sources</b>	
<b>DOLBY PLII MOVIE</b>	Movie
<b>DOLBY PLII MUSIC<sup>a</sup></b>	Music
<b>DOLBY PLII GAME</b>	Video games
<b>NEO:6 CINEMA<sup>b</sup></b>	Movie
<b>NEO:6 MUSIC<sup>b</sup></b>	Music
<b>Multichannel sources</b>	
<b>Straight Decode</b>	No additional effects

- You can also adjust the **C.WIDTH**, **DIMEN.**, and **PNRM.** effect (see [Setting the Audio options on page 24](#)).
- You can also adjust the **C.IMG** effect (see [Setting the Audio options on page 24](#)).

## Playing back in the STEREO mode



When you select **STEREO**, you will hear the source through just the front left and right speakers (and possibly your subwoofer depending on your speaker settings). Dolby Digital and DTS multichannel sources are downmixed to stereo.

When the headphones are connected, **STEREO** can only be selected.

## Using the DSP



The DSP feature creates a variety of surround effects. Try different modes with various soundtracks to see which you like.

<b>All Ch Stereo</b>	Gives multichannel sound to a stereo source, using all of your speakers.
<b>TV Logic</b>	Designed for movies with lots of dialog.
<b>Game-Action</b>	Designed for action movies with dynamic soundtracks.
<b>Game-RPG</b>	Suitable for video games.
<b>Game-Sports</b>	Suitable for sports programs.
<b>Game-Rock</b>	Creates a live concert sound for rock and/or pop music.
<b>Orchestra</b>	Gives a large concert hall-type sound.

## Using Direct



Use the Direct modes when you want to hear the truest possible reproduction of a source. All unnecessary signal processing is bypassed.

<b>DIRECT</b>	Sources are heard according to the settings made in the Manual SP Setup (speaker setting, X.Over, channel level, speaker distance), as well as with dual mono settings. You will hear sources according to the number of channels in the signal. A/V SYNC, Fixed PCM, HDMI Audio and Auto Delay functions are available.
---------------	---

## Using the Music Optimizer M.OPT

When audio data is removed during the compression process, sound quality often suffers from an uneven sound image. The Music Optimizer feature employs new DSP technology that helps bring CD quality sound back to compressed 2-channel audio by restoring sound pressure and smoothing jagged artifacts left over after compression.

▶ Press **M.OPT** to switch the **M.OPT (Music Optimizer)** ON or OFF.

### Note

- The Music Optimizer mode cannot be set to **ON**, when the **DIRECT** mode is switched on.

## Setting the Audio options

There are a number of additional sound settings you can make using the **QUICK MENU** menu. The defaults, if not stated, are listed in bold.

### Important

- Note that if a setting doesn't appear in the **QUICK MENU** menu, it is unavailable due to the current source, settings and status of the receiver.

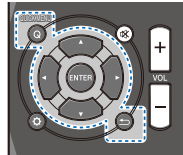

- 1 Press **QUICK MENU** button.
- 2 Use **↑/↓** to select the setting you want to adjust.  
Depending on the current status/mode of the receiver, certain options may not be able to be selected. Check the table below for notes on this.
- 3 Use **↔** to set it as necessary.  
See the table below for the options available for each setting.
- 4 Press **↵** to confirm and exit the menu.

Setting/What it does	Option(s)
<b>AV. SYN</b> (A/V SYNC) Some monitors have a slight delay when showing video, so the soundtrack will be slightly out of sync with the picture. By adding a bit of delay, you can adjust the sound to match the presentation of the video.	<i>0 ms to 500 ms</i> (1 step : 5 ms) Default: <b>0</b>
<b>M.OPT</b> (Music Optimizer) <sup>a</sup> Switches on/off the effect of Music Optimizer. (see <a href="#">Using the Music Optimizer on page 24</a> )	<b>OFF</b> <sup>b</sup> <b>ON</b>

Setting/What it does	Option(s)
<b>DUAL MONO</b> <sup>c</sup> Specifies how dual mono encoded Dolby Digital soundtracks should be played.	<b>CH1</b> – Channel 1 is heard only <b>CH2</b> – Channel 2 is heard only <b>CH1 CH2</b> – Both channels heard from front speakers
<b>F.PCM</b> (Fixed PCM) <sup>d</sup> This is useful if you find there is a slight delay before <b>OFF</b> recognizes the PCM signal on a CD, for instance. When <b>ON</b> is selected, noise may be output during playback of non-PCM sources. Please select another input signal if this is a problem.	<b>OFF</b> <b>ON</b>
<b>LATE NIGHT</b> Adjusts the level of dynamic range for movie soundtracks optimized for Dolby Digital, DTS, Dolby Digital Plus, Dolby TrueHD, DTS-HD and DTS-HD Master Audio (you may need to use this feature when listening to surround sound at low volumes).	<b>AUTO</b> <sup>e</sup> <b>OFF</b> <b>MID</b> <b>MAX</b>
<b>HDMI</b> (HDMI Audio) Specifies the routing of the HDMI audio signal out of this receiver ( <b>AMP</b> ) or through to a TV ( <b>THRU</b> ). When <b>THRU</b> is selected, no sound is output from this receiver.	<b>AMP</b> <b>THRU</b>
<b>A.DLY</b> (Auto Delay) <sup>f</sup> This feature automatically corrects the audio-to-video delay between components connected with an HDMI cable. The audio delay time is set depending on the operational status of the display connected with an HDMI cable. The video delay time is automatically adjusted according to the audio delay time.	<b>OFF</b> <b>ON</b>

Setting/What it does	Option(s)
<b>C.WIDTH</b> (Center Width) <sup>g</sup> (Applicable only when using a center speaker) Spreads the center channel between the front right and left speakers, making it sound wider (higher settings) or narrower (lower settings). Making the C.WIDTH setting "7" may cause no sound to be output from the center channel.	0 to 7 Default: <b>3</b>
<b>DIMEN.</b> (Dimension) <sup>g</sup> Adjusts the surround sound balance from front to back, making the sound more distant (minus settings), or more forward (positive settings).	-3 to +3 Default: <b>0</b>
<b>PNRM.</b> (Panorama) <sup>g</sup> Extends the front stereo image to include surround speakers for a 'wraparound' effect.	<b>OFF</b> <b>ON</b>
<b>C.IMG</b> (Center Image) <sup>h</sup> (Applicable only when using a center speaker) Adjust the center image to create a wider stereo effect with vocals. Adjust the effect from <b>0</b> (all center channel sent to front right and left speakers) to <b>10</b> (center channel sent to the center speaker only).	0 to 10 Default: <b>3</b> (NEO:6 MUSIC), <b>10</b> (NEO:6 CINEMA) CINEMA)

- a. You can change the Music Optimizer feature at any time by using **M.OPT** button.
- b. The default setting when the **USB** input is selected is **ON**.
- c. This setting works only with dual mono encoded Dolby Digital and DTS soundtracks.
- d. This is not displayed by default. You need to change some settings on this unit to display the menu. (see [Displaying the Fixed PCM Setting menu on page 26](#)).
- e. The initial set **AUTO** is only available for Dolby TrueHD signals. Select **MAX** or **MID** for signals other than Dolby TrueHD.
- f. This feature is only available when the connected display supports the automatic audio/video synchronizing capability ('lip-sync') for HDMI. If you find the automatically set delay time unsuitable, set **A.DLY** to **OFF** and adjust the delay time manually. For more details about the lip-sync feature of your display, contact the manufacturer directly.
- g. Only available with 2-channel sources in **DOLBY PLII MUSIC** mode.
- h. Only when listening to 2-channel sources in **NEO:6 CINEMA** and **NEO:6 MUSIC** mode.



- The functions that can be set differ depending on the input signal or speaker settings.

	DIRECT		STEREO	SURR	DSP	Using the headphones
	Analog/BT Audio signal	Other signals				
Speaker Setting	x	✓	✓	✓	✓	x
Channel Level	✓	✓	✓	✓	✓	x
Speaker Distance	x	✓	✓	✓	✓	x
Bass/Treble	x	x	✓	✓	✓	✓
A/V SYNC	x	✓	✓	✓	✓	✓
Music Optimizer	x	x	✓	✓	✓	✓
DUAL MONO	x	✓	✓	✓	✓	✓
Fixed PCM	x	✓	✓	✓	✓	✓
LATE NIGHT	x	x	✓	✓	✓	✓
HDMI Audio	x	✓	✓	✓	✓	✓
Auto Delay	x	✓	✓	✓	✓	✓
Center Image (NEO:6 only)	x	x	x	✓	x	x

### Displaying the Fixed PCM Setting menu

The **Fixed PCM** Audio options are not displayed by default. Perform the following operations to display them.

- 1 Switch the receiver into standby.
- 2 While holding down **AUTO SURROUND/STREAM DIRECT** on the front panel, hold **ON/STANDBY**.  
The setting switches between display and hide each time you operate these steps.

### Changing the TV format setting of Graphical User Interface (Except for the U.S.A., Canada and Latin America models)

If the Graphical User Interface screen is not displayed correctly, it may be that the TV system is set incorrectly for your country or region.

- 1 Switch the receiver into standby.
- 2 While holding down **TUNING ▲** on the front panel, hold **ON/STANDBY**.  
Each press switches between **PAL** and **NTSC**.
  - Default: **PAL**

### Changing the frequency step of AM Radio (Except for the U.S.A., Canada and Latin America models)

If you find that you can't tune into stations successfully, the frequency step may not be suitable for your country/region. Here's how to switch the setting:

- 1 Switch the receiver into standby.
- 2 While holding down ▼ TUNING on the front panel, hold ON/STANDBY.  
Each press switches between 9K STEP and 10K STEP.
  - Default: 9K STEP

#### Note

- If the Standby Through is not set to OFF, you may not be able to set the switching of the Fixed PCM, NTSC/PAL or 9K STEP/10K STEP



# 5: Setup

## Using the Setup

The following section shows you how to make detailed settings to specify how you're using the receiver, and also explains how to fine-tune individual speaker system settings to your liking.





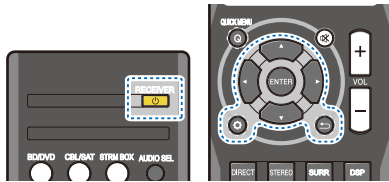

### Important

- The OSD will not appear if you have connected using the composite output to your TV. Use HDMI connections for Setup.
- If headphones are connected to the receiver, disconnect them.
- You can't use the Setup when the **USB** input is selected.



- 1 Switch on the receiver and your TV.**  
Press **RECEIVER** to switch on.

- 2 Switch the TV input to the input that connects this receiver to the TV through the corresponding HDMI cable.**

- 3 Press .**  
The Setup appears on your TV. Use , , ,  and **ENTER** on the remote control to navigate through the screens and select menu items. Press  to exit the current menu.

- Press  at any time to exit the Setup.

## 4 Select the setting you want to adjust.

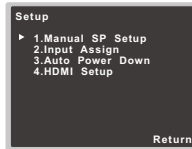

- **Manual SP Setup**
  - **Speaker Setting** – Specify the size and number of speakers you've connected (see below).
  - **X.Over** – Specify which frequencies will be sent to the subwoofer ([page 29](#)).
  - **Channel Level** – Adjust the overall balance of your speaker system ([page 29](#)).
  - **Speaker Distance** – Specify the distance of your speakers from the listening position ([page 30](#)).
- **Input Assign** – Specify what you've connected to the **(CD)** audio input (see [The Input Assign menu on page 30](#)).
- **Auto Power Down** – Sets to automatically turn off the power when the receiver has not operated for several hours (see [The Auto Power Down menu on page 31](#)).
- **HDMI Setup** – Set the audio return channel function and set the HDMI input signal to Standby Through output or not during standby (see [The HDMI Setup menu on page 31](#)).

## Manual speaker setup

This receiver allows you to make detailed settings to optimize the surround sound performance. You only need to make these settings once (unless you change the placement of your current speaker system or add new speakers).



### Speaker Setting

Use this setting to specify your speaker configuration (size, number of speakers).

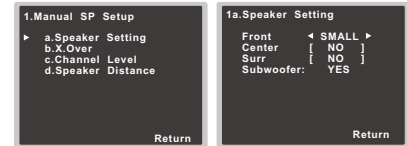
- 1 Select 'Manual SP Setup' from the Setup.**
- 2 Select 'Speaker Setting' from the Manual SP Setup menu.**



- 3 Choose the set of speakers that you want to set then select a speaker size.**

Use ,  to select the size (and number) of each of the following speakers:

- **Front** – Select **LARGE** if your front speakers reproduce bass frequencies effectively, or if you didn't connect a subwoofer. Select **SMALL** to send the bass frequencies to the subwoofer.
- **Center** – Select **LARGE** if your center speaker reproduces bass frequencies effectively, or select **SMALL** to send bass frequencies to the other speakers or subwoofer. If you didn't connect a center speaker, choose **NO** (the center channel is sent to the other speakers).
- **Surr** – Select **LARGE** if your surround speakers reproduce bass frequencies effectively. Select **SMALL** to send bass frequencies to the other speakers or subwoofer. If you didn't connect surround speakers choose **NO** (the sound of the surround channels is sent to the other speakers).

- **Subwoofer** – LFE signals and bass frequencies of channels set to **SMALL** are output from the subwoofer when **YES** is selected (see notes below). Choose the **PLUS** setting if you want the subwoofer to output bass sound continuously or you want deeper bass (the bass frequencies that would normally come out the front and center speakers are also routed to the subwoofer). If you did not connect a subwoofer choose **NO** (the bass frequencies are output from other speakers).

#### 4 When you're finished, press ↩.

You return to the Manual SP Setup menu.

#### Note

- If you select **SMALL** for the front speakers, the subwoofer will automatically be fixed to **YES**. Also, the center, surround can't be set to **LARGE** if the front speakers are set to **SMALL**. In this case, all bass frequencies are sent to the subwoofer.
- If you have a subwoofer and like lots of bass, it may seem logical to select **LARGE** for your front speakers and **PLUS** for the subwoofer. This may not, however, yield the best bass results. Depending on the speaker placement of your room you may actually experience a decrease in the amount of bass due to low frequency cancellations. In this case, try changing the position or direction of speakers. If you can't get good results, listen to the bass response with it set to **PLUS** and **YES** or the front speakers set to **LARGE** and **SMALL** alternatively and let your ears judge which sounds best. If you're having problems, the easiest option is to route all the bass sounds to the subwoofer by selecting **SMALL** for the front speakers.

### X.Over

- Default setting: **200Hz**

This setting decides the cutoff between bass sounds playing back from the speakers selected as **LARGE**, or the subwoofer, and bass sounds playing back from those selected as **SMALL**. It also decides where the cutoff will be for bass sounds in the LFE channel.

- For more on selecting the speaker sizes, see [Speaker Setting on page 28](#).

#### 1 Select 'Manual SP Setup' from the Setup.

#### 2 Select 'X.Over' from the Manual SP Setup menu.



#### 3 Choose the frequency cutoff point.

Frequencies below the cutoff point will be sent to the subwoofer (or **LARGE** speakers).

#### 4 When you're finished, press ↩.

You return to the Manual SP Setup menu.

### Channel Level

Using the channel level settings, you can adjust the overall balance of your speaker system, an important factor when setting up a home theater system.

#### CAUTION

- The test tones used in the Channel Level settings are output at high volume.

#### 1 Select 'Manual SP Setup' from the Setup.

#### 2 Select 'Channel Level' from the Manual SP Setup menu.

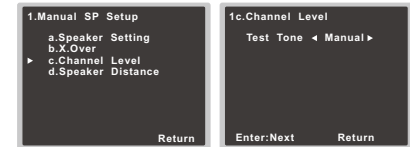

#### 3 Select a setup option.

- **Manual** – Move the test tone manually from speaker to speaker and adjust individual channel levels.
- **Auto** – Adjust channel levels as the test tone moves from speaker to speaker automatically.

#### 4 Confirm your selected setup option.

The test tones will start after you press **ENTER**. After the volume increases to the reference level, test tones will be output.

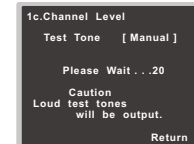

## 5 Adjust the level of each channel using ◀/▶.

If you selected **Manual**, use ▲/▼ to switch speakers. The **Auto** setup will output test tones in the order shown on-screen:

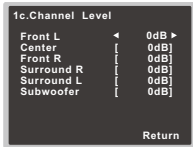

Adjust the level of each speaker as the test tone is emitted.

### Note

- If you are using a Sound Pressure Level (SPL) meter, take the readings from your main listening position and adjust the level of each speaker to 75 dB SPL (C-weighting/slow reading).
- The subwoofer test tone is output at low volumes. You may need to adjust the level after testing with an actual soundtrack.

## 6 When you're finished, press ↵.

You return to the Channel Level menu.

### Speaker Distance

For good sound depth from your system, you need to specify the distance of your speakers from the listening position. The receiver can then add the proper delay needed for effective surround sound.

- For the assignment of the digital signal inputs, see [Selecting the audio input signal on page 16](#).

## 1 Select 'Manual SP Setup' from the Setup.

## 2 Select 'Speaker Distance' from the Manual SP Setup menu.

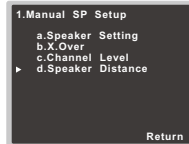

## 3 Adjust the distance of each speaker using ◀/▶. (For the U.S.A., Canada and Latin America models)

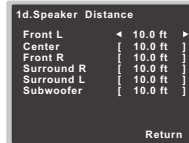

You can adjust the distance of each speaker in 0.1 ft. increments.

(For the other models)

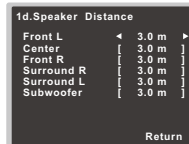

You can adjust the distance of each speaker in 0.1 m increments.

## 4 When you're finished, press ↵.

You return to the Manual SP Setup menu.

### The Input Assign menu

(CD) audio input terminal is assigned to CD under factory settings, but this can be changed to TV input.

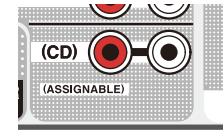

## 1 Select 'Input Assign' from the Setup.

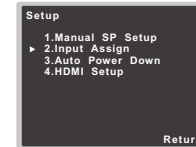

## 2 Select 'Analog Input' from the Input Assign menu.



## 3 Select the desired input option for the (CD) audio input terminal.

## 4 When you're finished, press ↵.

You return to the Input Assign menu.

## The Auto Power Down menu

Set to automatically turn off the receiver after a specified time has passed (when the power has been on with no operation for several hours).

(For the U.S.A., Canada and Latin America models)

- Default setting: **OFF**

(For the other models)

- Default setting: **6H**

### 1 Select 'Auto Power Down' from the Setup.

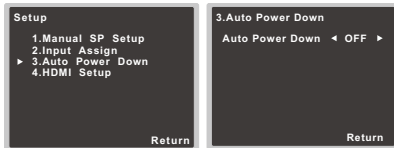

### 2 Specify the amount of time to allow before the power is turned off (when there has been no operation).

- You can select 2, 4 or 6 hours, or **OFF** (if no automatic shutoff is desired).

### 3 When you're finished, press $\leftarrow$ .

You return to the Setup.

## The HDMI Setup menu

If your TV supports an audio return channel (ARC) function, connect your TV and this unit with an HDMI cable and the TV audio will be inputted into this unit via the HDMI terminal without the need for an audio cable to be connected.

It is possible to transfer signals from an HDMI connected player to the TV even when this receiver's power is on standby.

### Important

- Use a High Speed HDMI<sup>®/TM</sup> Cable when using the ARC function. The ARC function may not operate properly with other HDMI cables.

### 1 Select 'HDMI Setup' from the Setup.



### 2 Choose the 'ARC' setting you want.

When a TV supporting the HDMI Audio Return Channel function is connected to the receiver, the sound of the TV can be input via the HDMI terminal.

- **ON** – The TV's sound is input via the HDMI terminal.
- **OFF** – The TV's sound is input from the audio input terminals other than HDMI inputs.

### 3 Choose the 'Standby Through' setting you want.

When the receiver is in standby, the HDMI input signal selected here will be output to the TV by HDMI.

- **LAST** – The HDMI input signal selected previously will be output.
- **BD/DVD, CBL/SAT, STRM BOX, GAME** – The HDMI input signal selected here will be output.
- **OFF** – Signal will not be output during standby.
  - If the **Standby Through** setting is not set to **OFF**, the power consumption during standby will increase.

### 4 Choose the '4k60p Setting' setting you want.

If the TV to be connected using HDMI supports 4K/60p, you can switch the 4k60p setting in accordance with TV performance.

1. Select an input terminal that you wish to change settings using  $\leftarrow/\rightarrow$ .

2. Use  $\uparrow/\downarrow$  to select '4k60p'.

3. Use  $\leftarrow/\rightarrow$  to select the signal to set.

- **4:4:4** – Select this setting when connecting to a 4K/60p 4:4:4 24 bit compatible TV using HDMI. More high quality video images can be enjoyed.

- When the HDMI cable does not support 4K/60p 4:4:4 24 bit (18 Gbps transmission), video image may not be output properly.

In that case, select 4:2:0 to watch a 4K/60p 4:2:0 24 bit video image.

- **4:2:0** – Select this setting when connecting to a 4K/60p 4:2:0 24 bit compatible TV using HDMI.

4. Press  $\leftarrow$ .

If certain source devices that do not support 4K/60p 4:4:4 24 bit are used and the HDMI terminal is set to 4:4:4, video output from the source device may turn red, no audio may be output by the source device, or a 3D signal may not be output by some of the devices. In these cases, set the HDMI terminal to 4:2:0.

### 5 When you're finished, press $\leftarrow$ .

You return to the Setup.

## Before starting ARC operation

When starting ARC operation, put the TV and this unit in STANDBY mode after connecting this unit with the TV. Next, turn ON the power of this unit and then the TV, in this order. In order to start ARC operation, after connecting this unit to a TV with an HDMI cable, you will need to switch the input on the TV to the input mode required to connect to this unit.

Then, you can select a TV program.

 **Important**

- The ARC function may not operate even if the above conditions are met. If this is the case, listen to the TV audio after connecting this unit and the TV with an audio cable.
- The CEC (Consumer Electronic Control) function may activate when the ARC function is turned ON, causing power to turn ON and OFF and the input to switch from one to another. Since this unit does not guarantee synchronized operation based on the CEC function, we recommend that you turn OFF the HDMI CONTROL setting on the connected player. This unit may not operate properly if the HDMI CONTROL on the player is ON. Refer to the relevant device's instruction manual for details. If this does not work, turn OFF the ARC function.  
If this is the case, listen to the TV audio after connecting this unit and the TV with an audio cable.  
In addition, this unit does not guarantee synchronized operation that allows the TV remote control to operate the volume (including mute). Use this unit to operate the volume (including mute).
- Turn OFF the power and remove the power cord from the wall socket when connecting other devices or making connection changes to this unit. After all connections are completed, insert the power cord into the wall socket.



# 6: Additional information

## Troubleshooting

Incorrect operations are often mistaken for trouble and malfunctions. If you think that there is something wrong with this component, check the points below. Take a look at the other components and electrical appliances being used, because sometimes the problem may lie there. If the trouble isn't sorted out even after going through the checks below, ask your nearest Onkyo authorized independent service company to carry out repair work.

- If the unit does not operate normally due to external effects such as static electricity disconnect the power plug from the outlet and insert again to return to normal operating conditions.

## General

### ❖ The power does not turn on.

→ Disconnect the power plug from the outlet, and insert again.

### ❖ The receiver suddenly switches off.

→ When the Auto Power Down function is working, the power will automatically turn off if the receiver has not operated for several hours. Check the setting for the Auto Power Down function (see [The Auto Power Down menu on page 31](#)).

→ Make sure there are no loose strands of speaker wire touching the rear panel. This could cause the receiver to shut off automatically.

→ After about a minute (you won't be able to switch the unit on during this time), switch the receiver back on. If the message persists, call a Onkyo authorized independent service company.

→ If there is very little low frequency information in the source material, change your speaker settings to Front: SMALL / Subwoofer: YES, or Front: LARGE / Subwoofer: PLUS ([page 28](#)).

### ❖ The input of this unit switches from one to another. (When the ARC function is ON)

→ The CEC (Consumer Electronic Control) function may activate when the ARC function is turned ON, causing the input to switch from one to another. Since this unit does not guarantee synchronized operation based on the CEC function, turn OFF the HDMI CONTROL setting on the connected player. Refer to the relevant device's instruction manual for details.

If this does not work, turn OFF the ARC function. If this is the case, listen to the TV audio after connecting this unit and the TV with an audio cable.

### ❖ OVERHEAT shows in the display and the power turns off.

→ The temperature within the unit has exceeded the allowable value. Try moving the unit for better ventilation.

→ Lower the volume level.

### ❖ TEMP shows in the display and the volume level drops.

→ The temperature within the unit has exceeded the allowable value. Try moving the unit for better ventilation.

→ Lower the volume level.

### ❖ No sound is output when an input function is selected.

→ Use **VOL +/-** to turn up the volume.

→ Press **MUTE** on the remote control to turn muting off.

→ Set the **AUDIO SEL** to H (HDMI), C1/O1 (digital) or A (analog) according to the type of connections made ([page 16](#)).

→ Make sure the component is connected correctly (see [Connecting your equipment on page 8](#)).

→ Check the audio output settings of the source component.

→ Refer to the instruction manual supplied with the source component.

### ❖ No image is output when an input function is selected.

→ Make sure the component is connected correctly (see [Connecting your equipment on page 8](#)).

→ Use the same type of video cables for the source component and TV to connect to this receiver (see [About video outputs connection on page 11](#)).

→ The video input selected on the TV monitor is incorrect. Refer to the instruction manual supplied with the TV.

### ❖ There is no bass.

→ When the listening mode is set to **DIRECT** with analog audio or BT Audio input, there is no output from the subwoofer so bass will not be output. Select a different listening mode if this occurs.

### ❖ No sound from subwoofer.

→ The Dolby Digital or DTS source you are listening to may not have an LFE channel.

→ Switch the subwoofer setting in [Speaker Setting on page 28](#) to **YES** or **PLUS**.

### ❖ No sound from surround or center speakers.

→ Connect the speakers properly ([page 9](#)).

→ Refer to [Speaker Setting on page 28](#) to check the speaker settings.

→ Refer to [Channel Level on page 29](#) to check the speaker levels.

### ❖ No sound from a specific speaker.

→ Make sure the speaker cable is connected correctly. (Ensure that the connection terminal is correct, that the speaker wire is firmly inserted, and that no speaker wire is touching the rear panel.)

### ❖ Considerable noise in radio broadcasts.

→ Connect the antenna ([page 14](#)) and adjust the position for best reception.

→ Route any loose cables away from the antenna terminals and wires.

→ Fully extend the FM wire antenna, position for best reception, and secure to a wall (or connect an outdoor FM antenna).

→ Connect an additional internal or external AM antenna ([page 14](#)).

→ Turn off equipment causing interference or move it away from the receiver (or move antennas farther away from equipment causing noise).

### ❖ Broadcast stations cannot be selected automatically.

→ Connect an outdoor antenna ([page 14](#)).

### ❖ Noise during playback of a cassette deck.

→ Move the cassette deck away from your receiver, until the noise disappears.

### ❖ No sound is output or a noise is output when software with DTS is played back.

→ Make sure the player's settings are correct and/or the DTS signal out is on. Refer to the instruction manual supplied with the DVD player.

### ❖ Can't operate the remote control.

→ Replace the batteries ([page 7](#)).

→ Operate within 7 m (23 ft.), 30° of the remote sensor ([page 7](#)).

→ Remove the obstacle or operate from another position.

→ Avoid exposing the remote sensor on the front panel to direct light.

### ❖ The display is dark.

→ Press **DIMMER** on the remote control repeatedly to return to the default.

### ❖ Display flashes and cannot be operated.

→ Depending on the input signal or listening mode, there may be functions that cannot be selected.

### ❖ The BLUETOOTH wireless technology device cannot be connected or operated. Sound from the BLUETOOTH



### wireless technology device is not emitted or the sound is interrupted.

- Check that no object that emits electromagnetic waves in the 2.4 GHz band (microwave oven, wireless LAN device or BLUETOOTH wireless technology apparatus) is near the receiver. If such an object is near the receiver, set the receiver far from it. Or, stop using the object emitting the electromagnetic waves.
  - Check that the BLUETOOTH wireless technology device is not too far from the receiver and that obstructions are not set between the BLUETOOTH wireless technology device and the receiver. Set the BLUETOOTH wireless technology device and the receiver so that the distance between them is less than about 10 m (33 ft.)\* and no obstructions exist between them.
- \* The line-of-sight transmission distance is an estimate. Actual transmission distances supported may differ depending on surrounding conditions.
- The BLUETOOTH wireless technology device may not be set to the communication mode supporting the BLUETOOTH wireless technology. Check the setting of the BLUETOOTH wireless technology device.
  - Check that pairing is correct. The pairing setting was deleted from this receiver or the BLUETOOTH wireless technology device. Reset the pairing.
  - Check that the profile is correct. Use a BLUETOOTH wireless technology device that supports A2DP profile.

## HDMI

### ❖ No picture or sound.

- If the problem still persists when connecting your HDMI component directly to your monitor, please consult the component or monitor manual or contact the manufacturer for support.

### ❖ No picture.

- Video signals that are input from the analog video terminal will not output from the HDMI terminal. Signals that are input from the HDMI terminal will not output from the analog video terminal. Be consistent with the type of cable between input and output.
- Depending in the output settings of the source component, it may be outputting a video format that can't be displayed. Change the output settings of the source, or connect using the composite video jacks.
- This receiver is HDCP-compatible. Check that the components you are connecting are also HDCP-compatible. If they are not, please connect them using the composite video jacks.
- Depending on the connected source component, it's possible that it will not work with this receiver (even if it is HDCP-compatible). In this case, connect using the composite video jacks between source and receiver.
- If video images do not appear on your TV, try adjusting the resolution, Deep Color or other setting for your component.
- To output signals in Deep Color, use an HDMI cable (High Speed HDMI<sup>®</sup>™ Cable) to connect this receiver to a component or TV with the Deep Color feature.

### ❖ The OSD screen (Setup, etc.) isn't displayed.

- The OSD will not appear if you have connected using the composite output to your TV. Use HDMI connections when setting up the system.

### ❖ No sound, or sound suddenly ceases.

- Check that the **HDMI** setting is set to **AMP** (page 24).
- If the component is a DVI device, use a separate connection for the audio.
- HDMI format digital audio transmissions require a longer time to be recognized. Due to this, interruption in the audio may occur when switching between audio formats or beginning playback.
- Turning on/off the device connected to this unit's HDMI OUT terminal during playback, or disconnecting/connecting the HDMI cable during playback, may cause noise or interrupted audio.

## Important information regarding the HDMI connection

There are cases where you may not be able to route HDMI signals through this receiver (this depends on the HDMI equipped component you are connecting-check with the manufacturer for HDMI compatibility information).

If you aren't receiving HDMI signals properly through this receiver (from your component), please try the following configuration when connecting up.

### Configuration

Connect your HDMI-equipped component directly to the display using an HDMI cable. Then use the most convenient connection (digital is recommended) for sending audio to the receiver. See the operating instructions for more on audio connections. Set the display volume to minimum when using this configuration.

### Note

- Depending on the component, audio output may be limited to the number of channels available from the connected display unit (for example audio output is reduced to 2 channels for a monitor with stereo audio limitations).
- If you want to switch the input source, you'll have to switch functions on both the receiver and your display unit.
- Since the sound is muted on the display when using the HDMI connection, you must adjust the volume on the display every time you switch input sources.

## USB messages

### ❖ 'USB Error 4 (I/U ERR4)'

- The power requirements of the USB device are too high for this receiver. Switch off the receiver and reconnect the USB to the receiver.



## About the Speaker System

### Precautions

- Do not place heavy or large objects on top of the speaker. Doing so could provoke the speaker to fall, causing damages or bodily injury.
- Do not place the speaker on an unstable surface, as doing so may cause the speaker to fall and cause damage or bodily injury.
- Switch off and unplug your AV equipment and consult the instructions when connecting up components. Make sure you use the correct connecting cables.
- Do not sit or stand on the speaker, or let children play on the speaker. Doing so could provoke the speaker to fall, causing damages or bodily injury.
- Be careful to make sure children not to put their hands or any objects into the speaker duct\*.  
\*Speaker duct: A hole for plentiful bass sound on speaker cabinet (enclosure).
- Place the center speaker at a safe distance from the child's reach.  
Otherwise it may result in the speaker falling down and causing personal injury and/or property damage.
- Install the subwoofer in a well-ventilated location where it will not be exposed to high temperatures and high humidity.
- Do not place the subwoofer near stoves or other heating equipment or at locations exposed to direct sunlight, as these can have an adverse effect on the cabinet and internal components. Also, do not install the unit where there is too much dust or high humidity, as these can cause malfunctioning or breakdowns. (Avoid cooking tables and other locations where the unit would be exposed to heat, steam and soot.)
- Keep the subwoofer away from devices such as cassette decks which are sensitive to magnetic fields.
- Do not place cups, glasses, or other containers with fluids on top of the units, since the units may be damaged if the liquid spills.
- The installation location selected should have a sturdy floor surface. Mounting the subwoofer on a long-pile carpet should be avoided, since the carpet may touch the driver's diaphragm, causing distorted sound.
- Please install the subwoofer away from the antenna cable of the receiver, as noise can be caused with installation close to the antenna cable. In such a case, use the subwoofer at a position away from the antenna and the antenna cable.
- The front grilles on front/center/surround speakers cannot be removed. Do not try to forcibly remove them since doing so may damage the grille.
- When mounting front speakers or surround speakers on a wall surface, make sure that the wall you intend to mount the speakers on is strong enough to support them.
- Do not attach center speaker and subwoofer to the wall or ceiling, as they may cause injury in the event of a fall.
- Do not connect the supplied subwoofer to any amplifier other than the one supplied with this system. Connection to any other amplifier may result in malfunction or fire.
- Front/Center/Surround speakers incorporate autoregression technology to protect the speakers. If the speakers stop emitting noise when receiving too large a signal, turn the volume down on the receiver and wait a few seconds. The protection feature disables itself automatically.

## Effective Combination of Subwoofer and Front/Center/Surround speakers

- When the subwoofer is combined with Front/Center/Surround speakers in a total system, the sound characteristics produced are like those shown in the accompanying graph, depicting the enhancement of the bass frequencies. This is particularly effective for reproducing ground rumbles and other deep sound effects found in movies.

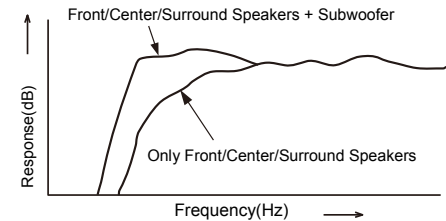

### Operation

- Set the receiver's cross-over frequency at 200 Hz. (see [X.Over on page 29](#)).

### Making amplifier settings

Select the speaker setting of the receiver. (see [Speaker Setting on page 28](#)).

- Front / Center / Surround speakers: SMALL



## Wall-mounting the Front/Center/Surround speaker system

### ⚠ CAUTION

- Use the M5 metric thread screw. Do not use inch thread screw.

### Before mounting

- Remember that the speaker system is heavy and that its weight could cause the wood screws to work loose, or the wall material to fail to support it, resulting in the speaker falling. Make sure that the wall on which you intend to mount the speakers is strong enough to support them. Do not mount on plywood or soft surface walls.
- Mounting screws are not supplied. Use screws suitable for the wall material and support the weight of the speaker. If you are unsure of the qualities and strength of the walls, consult a professional for advice.

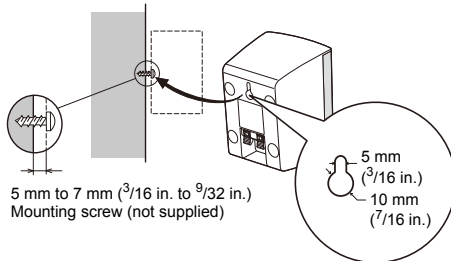

- To mount the center speaker horizontally, use the two keyhole slots shown to hang the speaker on two screws that are securely screwed into the wall.

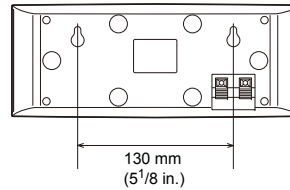

## Resetting the main unit

Use this procedure to reset all the receiver's settings to the factory default. Use the front panel controls to do this.

- Switch the receiver into standby.
- While holding down **STEREO**, press and hold **ON/STANDBY** for about two seconds.
- When you see **RESET?** appear in the display, press **SURROUND**. **OK?** shows in the display.
- Press **DSP** to confirm. **OK** appears in the display to indicate that the receiver has been reset to the factory default settings.

### 📌 Important

- If the **Standby Through** is not set to **OFF**, you may not be able to initialize the unit.

## Cleaning the unit

- Use a polishing cloth or dry cloth to wipe off dust and dirt.
- When the surface is dirty, wipe with a soft cloth dipped in some neutral cleanser diluted five or six times with water, and wrung out well, and then wipe again with a dry cloth. Do not use furniture wax or cleansers.
- Never use thinners, benzene, insecticide sprays or other chemicals on or near this unit, since these will corrode the surface.

## Specifications

### Audio section

*For the U.S.A., Canada and Latin America models*  
**Continuous average power output of 60 watts\* per channel, min., at 8 ohms, from 20 Hz to 20 000 Hz with no more than 0.7 %\*\* total harmonic distortion.**

Front (stereo) . . . . . 60 W + 60 W  
 Power output (1 kHz, 6 Ω, 0.7 %) . . . . . 100 W per channel

\* Measured pursuant to the Federal Trade Commission's Trade Regulation rule on Power Output Claims for Amplifiers  
 \*\* Measured by Audio Spectrum Analyzer

### For the other models

Rated power output  
 Front, Center, Surround  
 . . . . . 100 W per channel (1 kHz, 6 Ω, 0.7 %)

Total Harmonic Distortion  
 . . . . . 0.06 % (20 Hz to 20 kHz, 8 Ω, 50 W/ch)  
 Frequency response (LINE Pure Direct mode)  
 . . . . . 10 Hz to 100 kHz ±3 dB  
 Guaranteed speaker impedance . . . . . 6 Ω to 16 Ω  
 Input (Sensitivity/Impedance)  
 LINE . . . . . 250 mV/47 kΩ  
 Signal-to-Noise Ratio (IHF, short circuited, A network)  
 LINE . . . . . 98 dB

### Video Section

Signal level  
 Composite . . . . . 1 Vp-p (75 Ω)

### Tuner Section

Frequency Range (FM) . . . . . 87.5 MHz to 108 MHz  
 Antenna Input (FM) . . . . . 75 Ω unbalanced

### For the U.S.A., Canada and Latin America models

Frequency Range (AM) . . . . . 530 kHz to 1700 kHz

### For the other models

Frequency Range (AM)  
 9 kHz Step . . . . . 531 kHz to 1602 kHz  
 10 kHz Step . . . . . 530 kHz to 1700 kHz  
 Antenna (AM) . . . . . Loop antenna

### BLUETOOTH section

Version . . . . . BLUETOOTH Specification Ver. 3.0  
 Output . . . . . BLUETOOTH Specification Class 2  
 Estimated line-of-sight transmission distance\*  
 . . . . . About 10 m (33 ft.)  
 Frequency range . . . . . 2.4 GHz  
 Supported BLUETOOTH profiles . . . . . A2DP

Supported Codec . . . . . SBC (Subband Codec), AAC  
 \* The line-of-sight transmission distance is an estimate.  
 Actual transmission distances supported may differ depending on surrounding conditions.

### Digital In/Out Section

HDMI terminal . . . . . Type A (19-pin)  
 HDMI output type . . . . . 5 V, 55 mA  
 USB terminal . . . . . USB2.0 Full Speed (Type A) 5 V, 0.5 A

### Speaker section

Subwoofer  
 Cabinet . . . . . Bass-reflex, floor type  
 Speaker . . . . . 16 cm cone type  
 Nominal impedance . . . . . 6 Ω  
 Outline Dimension  
 . . . . . 230 mm (W) x 418 mm (H) x 358 mm (D)  
 9<sup>1</sup>/<sub>16</sub> in. (W) x 16<sup>7</sup>/<sub>16</sub> in. (H) x 14<sup>3</sup>/<sub>32</sub> in. (D)  
 Weight (without package) . . . . . 5.0 kg (11 lb)

### Front speakers / Surround speakers

Enclosure  
 Front speakers . . . . . Closed-box bookshelf type  
 Surround speakers . . . . . Closed-box bookshelf type  
 System . . . . . 7.7 cm 1-way system  
 Speaker . . . . . 7.7 cm cone type  
 Nominal impedance . . . . . 6 Ω  
 Dimensions . . . . . 100 mm (W) x 140 mm (H) x 95 mm (D)  
 3<sup>15</sup>/<sub>16</sub> in. (W) x 5<sup>1</sup>/<sub>2</sub> in. (H) x 3<sup>3</sup>/<sub>4</sub> in. (D)

### Weight

Front speakers . . . . . 0.55 kg (1 lb 3 oz)  
 Surround speakers . . . . . 0.55 kg (1 lb 3 oz)

### Center speaker

Enclosure . . . . . Closed-box bookshelf type  
 System . . . . . 7.7 cm 1-way system  
 Speaker . . . . . 7.7 cm cone type  
 Nominal impedance . . . . . 6 Ω  
 Dimensions . . . . . 240 mm (W) x 95 mm (H) x 95 mm (D)  
 9<sup>7</sup>/<sub>16</sub> in. (W) x 3<sup>3</sup>/<sub>4</sub> in. (H) x 3<sup>3</sup>/<sub>4</sub> in. (D)

Weight . . . . . 0.67 kg (1 lb 7 oz)

### Miscellaneous

#### For the U.S.A., Canada and Latin America models

Power Requirements . . . . . AC 120 V, 60 Hz

#### For the other models

Power Requirements . . . . . AC 220 V to 240 V, 50 Hz/60 Hz

Power Consumption . . . . . 190 W

In standby . . . . . 0.45 W

Dimensions . . . . . 435 mm (W) x 168 mm (H) x 326.5 mm (D)

17<sup>1</sup>/<sub>8</sub> in. (W) x 6<sup>5</sup>/<sub>8</sub> in. (H) x 12<sup>13</sup>/<sub>16</sub> in. (D)

Weight (without package) . . . . . 7.7 kg (16 lb 15 oz)



**Furnished Parts**

Remote control . . . . .	1
Dry cell batteries (AAA size IEC R03) . . . . .	2
AM loop antenna . . . . .	1
FM wire antenna . . . . .	1
Speaker cables (3 m/10 ft.) . . . . .	4
Speaker cables (8 m/26 ft.) . . . . .	2
Non-Skid Pads . . . . .	20
Quick start guide	
Safety Brochure	

**Note**

- Specifications and the design are subject to possible modifications without notice, due to improvements.



*Manufactured under license from Dolby Laboratories. Dolby, Pro Logic, and the double-D symbol are trademarks of Dolby Laboratories.*



*For DTS patents, see <http://patents.dts.com>. Manufactured under license from DTS Licensing Limited. DTS, DTS-HD, the Symbol, & DTS and the Symbol together are registered trademarks of DTS, Inc. © DTS, Inc. All Rights Reserved.*



The BLUETOOTH® word mark and logos are registered trademarks owned by Bluetooth SIG, Inc. and any use of such marks by Onkyo & Pioneer Corporation is under license.

Other trademarks and trade names are those of their respective owners.



## Software license notice

The licenses for the open source software used on this product are shown below. For accuracy purposes, here we have included the original texts (in English).

### ❖ FreeRTOS V6.0.5

#### Copyright (C) 2009 Real Time Engineers Ltd.

The FreeRTOS.org source code is licensed by the modified GNU General Public License (GPL) text provided below.

An exception to this license exists that can be applied should you wish to use FreeRTOS in a work that includes commercial or proprietary code without being obliged to provide source code for the proprietary components. See the licensing section of <http://www.FreeRTOS.org> for full details.

### GNU GENERAL PUBLIC LICENSE

Version 2, June 1991

Copyright (C) 1989, 1991 Free Software Foundation, Inc., 51 Franklin Street, Fifth Floor, Boston, MA 02110-1301 USA Everyone is permitted to copy and distribute verbatim copies of this license document, but changing it is not allowed.

#### Preamble

The licenses for most software are designed to take away your freedom to share and change it. By contrast, the GNU General Public License is intended to guarantee your freedom to share and change free software—to make sure the software is free for all its users. This General Public License applies to most of the Free Software Foundation's software and to any other program whose authors commit to using it. (Some other Free Software Foundation software is covered by the GNU Lesser General Public License instead.) You can apply it to your programs, too. When we speak of free software, we are referring to freedom, not price. Our General Public Licenses are designed to make sure that you have the freedom to distribute copies of free software (and charge for this service if you wish), that you receive source code or can get it if you want it, that you can change the software or use pieces of it in new free programs; and that you know you can do these things.

To protect your rights, we need to make restrictions that forbid anyone to deny you these rights or to ask you to surrender the rights. These restrictions translate to certain responsibilities for you if you distribute copies of the software, or if you modify it.

For example, if you distribute copies of such a program, whether gratis or for a fee, you must give the recipients all the rights that you have. You must make sure that they, too, receive or can get the source code. And you must show them these terms so they know their rights.

We protect your rights with two steps: (1) copyright the software, and (2) offer you this license which gives you legal permission to copy, distribute and/or modify the software.

Also, for each author's protection and ours, we want to make certain that everyone understands that there is no warranty for this free software. If the software is modified by someone else and passed on, we want its recipients to know that what they have is not the original, so that any problems introduced by others will not reflect on the original authors' reputations.

Finally, any free program is threatened constantly by software patents. We wish to avoid the danger that redistributors of a free program will individually obtain patent licenses, in effect making the program proprietary. To prevent this, we have made it clear that any patent must be licensed for everyone's free use or not licensed at all.

The precise terms and conditions for copying, distribution and modification follow.

### GNU GENERAL PUBLIC LICENSE

#### TERMS AND CONDITIONS FOR COPYING, DISTRIBUTION AND MODIFICATION

0. This License applies to any program or other work which contains a notice placed by the copyright holder saying it may be distributed under the terms of this General Public License. The "Program", below, refers to any such program or work, and a "work based on the Program" means either the Program or any derivative work under copyright law: that is to say, a work containing the Program or a portion of it, either verbatim or with modifications and/or translated into another language. (Hereinafter, translation is included without limitation in the term "modification".) Each licensee is addressed as "you".

Activities other than copying, distribution and modification are not covered by this License; they are outside its scope. The act of running the Program is not restricted, and the output from the Program is covered only if its contents constitute a work based on the Program (independent of having been made by running the Program). Whether that is true depends on what the Program does.

1. You may copy and distribute verbatim copies of the Program's source code as you receive it, in any medium, provided that you conspicuously and appropriately publish on each copy an appropriate copyright notice and disclaimer of warranty; keep intact all the notices that refer to this License and to the absence of any warranty; and give any other recipients of the Program a copy of this License along with the Program.

You may charge a fee for the physical act of transferring a copy, and you may at your option offer warranty protection in exchange for a fee.

2. You may modify your copy or copies of the Program or any portion of it, thus forming a work based on the Program, and copy and distribute such modifications or work under the terms of Section 1 above, provided that you also meet all of these conditions:

- a) You must cause the modified files to carry prominent notices stating that you changed the files and the date of any change.
- b) You must cause any work that you distribute or publish, that in whole or in part contains or is derived from the Program or any part thereof, to be licensed as a whole at no charge to all third parties under the terms of this License.
- c) If the modified program normally reads commands interactively when run, you must cause it, when started running for such interactive use in the most ordinary way, to print or display an announcement including an appropriate copyright notice and a notice that there is no warranty (or else, saying that you provide a warranty) and that users may redistribute the program under these conditions, and telling the user how to view a copy of this License. (Exception: if the Program itself is interactive but does not normally print such an announcement, your work based on the Program is not required to print an announcement.)

These requirements apply to the modified work as a whole. If identifiable sections of that work are not derived from the Program, and can be reasonably considered independent and separate works in themselves, then this License, and its terms, do not apply to those sections when you distribute them as separate works. But when you distribute the same sections as part of a whole which is a work based on the Program, the distribution of the whole must be on the terms of this License, whose permissions for other licensees extend to the entire whole, and thus to each and every part regardless of who wrote it.

Thus, it is not the intent of this section to claim rights or contest your rights to work written entirely by you; rather, the intent is to exercise the right to control the distribution of derivative or collective works based on the Program.

In addition, mere aggregation of another work not based on the Program with the Program (or with a work based on the Program) on a volume of a storage or distribution medium does not bring the other work under the scope of this License.

3. You may copy and distribute the Program (or a work based on it, under Section 2) in object code or executable form under the terms of Sections 1 and 2 above provided that you also do one of the following:
  - a) Accompany it with the complete corresponding machine-readable source code, which must be distributed under the terms of Sections 1 and 2 above on a medium customarily used for software interchange; or,
  - b) Accompany it with a written offer, valid for at least three years, to give any third party, for a charge no more than your cost of physically performing source distribution, a complete machine-readable copy of the corresponding source code, to be distributed under the terms of Sections 1 and 2 above on a medium customarily used for software interchange; or,
  - c) Accompany it with the information you received as to the offer to distribute corresponding source code. (This alternative is allowed only for noncommercial distribution and only if you received the program in object code or executable form with such an offer, in accord with Subsection b above.)

The source code for a work means the preferred form of the work for making modifications to it. For an executable work, complete source code means all the source code for all modules it contains, plus any associated interface definition files, plus the scripts used to control compilation and installation of the executable. However, as a special exception, the source code distributed need not include anything that is normally distributed (in either source or binary form) with the major components (compiler, kernel, and so on) of the operating system on which the executable runs, unless that component itself accompanies the executable.

If distribution of executable or object code is made by offering access to copy from a designated place, then offering equivalent access to copy the source code from the same place counts as distribution of the source code, even though third parties are not compelled to copy the source along with the object code.

4. You may not copy, modify, sublicense, or distribute the Program except as expressly provided under this License. Any attempt otherwise to copy, modify, sublicense or distribute the Program is void, and will automatically terminate your rights under this License.



However, parties who have received copies, or rights, from you under this License will not have their licenses terminated so long as such parties remain in full compliance.

5. You are not required to accept this License, since you have not signed it. However, nothing else grants you permission to modify or distribute the Program or its derivative works. These actions are prohibited by law if you do not accept this License. Therefore, by modifying or distributing the Program (or any work based on the Program), you indicate your acceptance of this License to do so, and all its terms and conditions for copying, distributing or modifying the Program or works based on it.
6. Each time you redistribute the Program (or any work based on the Program), the recipient automatically receives a license from the original licensor to copy, distribute or modify the Program subject to these terms and conditions. You may not impose any further restrictions on the recipients' exercise of the rights granted herein. You are not responsible for enforcing compliance by third parties to this License.
7. If, as a consequence of a court judgment or allegation of patent infringement or for any other reason (not limited to patent issues), conditions are imposed on you (whether by court order, agreement or otherwise) that contradict the conditions of this License, they do not excuse you from the conditions of this License. If you cannot distribute so as to satisfy simultaneously your obligations under this License and any other pertinent obligations, then as a consequence you may not distribute the Program at all. For example, if a patent license would not permit royalty-free redistribution of the Program by all those who receive copies directly or indirectly through you, then the only way you could satisfy both it and this License would be to refrain entirely from distribution of the Program.  
If any portion of this section is held invalid or unenforceable under any particular circumstance, the balance of the section is intended to apply and the section as a whole is intended to apply in other circumstances.  
It is not the purpose of this section to induce you to infringe any patents or other property right claims or to contest validity of any such claims; this section has the sole purpose of protecting the integrity of the free software distribution system, which is implemented by public license practices. Many people have made generous contributions to the wide range of software distributed through that system in reliance on consistent application of that system; it is up to the author/donor to decide if he or she is willing to distribute software through any other system and a licensee cannot impose that choice.  
This section is intended to make thoroughly clear what is believed to be a consequence of the rest of this License.
8. If the distribution and/or use of the Program is restricted in certain countries either by patents or by copyrighted interfaces, the original copyright holder who places the Program under this License may add an explicit geographical distribution limitation excluding those countries, so that distribution is permitted only in or among countries not thus excluded. In such case, this License incorporates the limitation as if written in the body of this License.
9. The Free Software Foundation may publish revised and/or new versions of the General Public License from time to time. Such new versions will be similar in spirit to the present version, but may differ

in detail to address new problems or concerns.

- Each version is given a distinguishing version number. If the Program specifies a version number of this License which applies to it and "any later version", you have the option of following the terms and conditions either of that version or of any later version published by the Free Software Foundation. If the Program does not specify a version number of this License, you may choose any version ever published by the Free Software Foundation.
10. If you wish to incorporate parts of the Program into other free programs whose distribution conditions are different, write to the author to ask for permission. For software which is copyrighted by the Free Software Foundation, write to the Free Software Foundation; we sometimes make exceptions for this. Our decision will be guided by the two goals of preserving the free status of all derivatives of our free software and of promoting the sharing and reuse of software generally.

#### NO WARRANTY

11. BECAUSE THE PROGRAM IS LICENSED FREE OF CHARGE, THERE IS NO WARRANTY FOR THE PROGRAM, TO THE EXTENT PERMITTED BY APPLICABLE LAW. EXCEPT WHEN OTHERWISE STATED IN WRITING THE COPYRIGHT HOLDERS AND/OR OTHER PARTIES PROVIDE THE PROGRAM "AS IS" WITHOUT WARRANTY OF ANY KIND, EITHER EXPRESSED OR IMPLIED, INCLUDING, BUT NOT LIMITED TO, THE IMPLIED WARRANTIES OF MERCHANTABILITY AND FITNESS FOR A PARTICULAR PURPOSE. THE ENTIRE RISK AS TO THE QUALITY AND PERFORMANCE OF THE PROGRAM IS WITH YOU. SHOULD THE PROGRAM PROVE DEFECTIVE, YOU ASSUME THE COST OF ALL NECESSARY SERVICING, REPAIR OR CORRECTION.
12. IN NO EVENT UNLESS REQUIRED BY APPLICABLE LAW OR AGREED TO IN WRITING WILL ANY COPYRIGHT HOLDER, OR ANY OTHER PARTY WHO MAY MODIFY AND/OR REDISTRIBUTE THE PROGRAM AS PERMITTED ABOVE, BE LIABLE TO YOU FOR DAMAGES, INCLUDING ANY GENERAL, SPECIAL, INCIDENTAL OR CONSEQUENTIAL DAMAGES ARISING OUT OF THE USE OR INABILITY TO USE THE PROGRAM (INCLUDING BUT NOT LIMITED TO LOSS OF DATA OR DATA BEING RENDERED INACCURATE OR LOSSES SUSTAINED BY YOU OR THIRD PARTIES OR A FAILURE OF THE PROGRAM TO OPERATE WITH ANY OTHER PROGRAMS), EVEN IF SUCH HOLDER OR OTHER PARTY HAS BEEN ADVISED OF THE POSSIBILITY OF SUCH DAMAGES.

#### END OF TERMS AND CONDITIONS

#### How to Apply These Terms to Your New Programs

If you develop a new program, and you want it to be of the greatest possible use to the public, the best way to achieve this is to make it free software which everyone can redistribute and change under these terms

To do so, attach the following notices to the program. It is safest to attach them to the start of each source file to most effectively convey the exclusion of warranty; and each file should have at least the "copyright" line and a pointer to where the full notice is found.

```
<one line to give the program's name and a brief idea of what it does.>
```

```
Copyright (C) <year> <name of author>
```

This program is free software; you can redistribute it and/or modify it under the terms of the GNU General Public License as published by the Free Software Foundation; either version 2 of the License, or (at your option) any later version.

This program is distributed in the hope that it will be useful, but WITHOUT ANY WARRANTY; without even the implied warranty of MERCHANTABILITY or FITNESS FOR A PARTICULAR PURPOSE. See the GNU General Public License for more details. You should have received a copy of the GNU General Public License along with this program; if not, write to the Free Software Foundation, Inc., 51 Franklin Street, Fifth Floor, Boston, MA 02110-1301 USA.

Also add information on how to contact you by electronic and paper mail.

If the program is interactive, make it output a short notice like this when it starts in an interactive mode:

```
Gnomovision version 69, Copyright (C) year name of author
Gnomovision comes with ABSOLUTELY NO WARRANTY; for
details type `show w'.
```

This is free software, and you are welcome to redistribute it under certain conditions: type `show c' for details.

The hypothetical commands `show w' and `show c' should show the appropriate parts of the General Public License. Of course, the commands you use may be called something other than `show w' and `show c'; they could even be mouse-clicks or menu items—whatever suits your program.

You should also get your employer (if you work as a programmer) or your school, if any, to sign a "copyright disclaimer" for the program, if necessary. Here is a sample; alter the names:

```
Yoyodyne, Inc., hereby disclaims all copyright interest in the
program `Gnomovision' (which makes passes at compilers) written
by James Hacker.
<signature of Ty Coon>, 1 April 1989
Ty Coon, President of Vice
```

This General Public License does not permit incorporating your program into proprietary programs. If your program is a subroutine library, you may consider it more useful to permit linking proprietary applications with the library. If this is what you want to do, use the GNU Lesser General Public License instead of this License.

EOF



# ONKYO

2-3-12 Yaesu, Chuo-ku, Tokyo 104-0028 JAPAN

<http://www.onkyo.com/>

## <U.S.A.>

18 Park Way, Upper Saddle River, N.J. 07458, U.S.A.

For Dealer, Service, Order and all other Business Inquiries:

Tel: 201-785-2600 Fax: 201-785-2650

<http://www.us.onkyo.com/>

For Product Support Team Only:

1-800-229-1687

<http://www.us.onkyo.com/>

## <Germany>

Gutenbergstrasse 3, 82178 Puchheim, Germany

Tel: +49-8142-4401-0 Fax: +49-8142-4208-213

<http://www.eu.onkyo.com/>

## <UK>

Anteros Building, Odyssey Business Park, West End Road, South Ruislip, Middlesex, HA4 6QQ United Kingdom

Tel: +44 (0)871-200-1996 Fax: +44 (0)871-200-1995

## <Hong Kong>

Unit 1033, 10/F, Star House, No 3, Salisbury Road, Tsim Sha Tsui Kowloon, Hong Kong.

Tel: +852-2429-3118 Fax: +852-2428-9039

<http://www.hk.onkyo.com/>

## <PRC>

302, Building 1, 20 North Chaling Rd., Xuhui District, Shanghai, China 200032,

Tel: +86-21-52131366 Fax: +86-21-52130396

<http://www.cn.onkyo.com/>

## <Asia, Oceania, Middle East, Africa>

Please contact an Onkyo distributor referring to Onkyo SUPPORT site.

<http://www.intl.onkyo.com/support/>

Корпорация О энд Пи

2-3-12, Яэсу, Чуо-ку, г. Токио, 104-0028, ЯПОНИЯ

The above-mentioned information is subject to change without prior notice.

Visit the Onkyo web site for the latest update.

(C) Copyright 2016 Onkyo & Pioneer Corporation Japan. All rights reserved.