



**DRAPER**<sup>®</sup>

EHV/SAFETY

# EXCLUSION ZONE KIT

99464



These instructions accompanying the product are the original instructions. This document is part of the product, keep it for the life of the product passing it on to any subsequent holder of the product. Read all these instructions before assembling, operating or maintaining this product.

This manual has been compiled by Draper Tools describing the purpose for which the product has been designed, and contains all the necessary information to ensure its correct and safe use. By following all the general safety instructions contained in this manual, it will ensure both product and operator safety, together with longer life of the product itself.

All photographs and drawings in this manual are supplied by Draper Tools to help illustrate the operation of the product.

Whilst every effort has been made to ensure the accuracy of information contained in this manual, the Draper Tools policy of continuous improvement determines the right to make modifications without prior warning.

# 1. TITLE PAGE

---

## 1.1 INTRODUCTION:

**USER MANUAL FOR:**  
**EHV/Safety Exclusion Zone**  
**Stock No: 99464**  
**Part No: EZONE**

## 1.2 REVISIONS:

---

**Date first published January 2020.**

---

As our user manuals are continually updated, users should make sure that they use the very latest version.

**Downloads are available from:** <http://drapertools.com/manuals>

Draper Tools Limited, Hursley Road  
Chandler's Ford, Eastleigh, Hampshire  
SO53 1YF. UK

**Website:** [drapertools.com](http://drapertools.com)

**Product Help Line:** +44 (0) 23 8049 4344

**General Fax:** +44 (0) 23 8026 0784

## 1.3 UNDERSTANDING THIS MANUALS SAFETY CONTENT:

**Warning!** – Information that draws attention to the risk of injury or death.

**Important** – Information that draws attention to the risk of damage to the product or surroundings.

## 1.4 COPYRIGHT © NOTICE:

Copyright © Draper Tools Limited.

Permission is granted to reproduce this publication for personal and educational use only. Commercial copying, redistribution, hiring or lending is prohibited.

No part of this publication may be stored in a retrieval system or transmitted in any other form or means without written permission from Draper Tools Limited. In all cases this copyright notice must remain intact.

# 2. WARRANTY

---

Draper tools have been carefully tested and inspected before shipment and are guaranteed to be free from defective materials and workmanship.

Should the tool develop a fault, please return the complete tool to your nearest distributor or contact:

**Draper Tools Limited, Chandler's Ford, Eastleigh, Hampshire, SO53 1YF. England.**

**Telephone Sales Desk: (023) 8049 4333 or  
Product Help Line (023) 8049 4344.**

A proof of purchase **must** be provided with the tool.

If upon inspection it is found that the fault occurring is due to defective materials or workmanship, repairs will be carried out free of charge. This warranty period covering parts and labour is 12 months from the date of purchase except where tools are hired out when the warranty period is 90 days from the date of purchase. This warranty does not apply to any consumable parts, any type of battery or normal wear and tear, nor does it cover any damage caused by misuse, careless or unsafe handling, alterations, accidents, or repairs attempted or made by any personnel other than the authorised Draper warranty repair agent.

**Note:** If the tool is found not to be within the terms of warranty, repairs and carriage charges will be quoted and made accordingly.

This warranty applies in lieu of any other warranty expressed or implied and variations of its terms are not authorised.

Your Draper warranty is not effective unless you can produce upon request a dated receipt or invoice to verify your proof of purchase within the warranty period.

Please note that this warranty is an additional benefit and does not affect your statutory rights.

**Draper Tools Limited.**

# 3. TECHNICAL DESCRIPTION

---

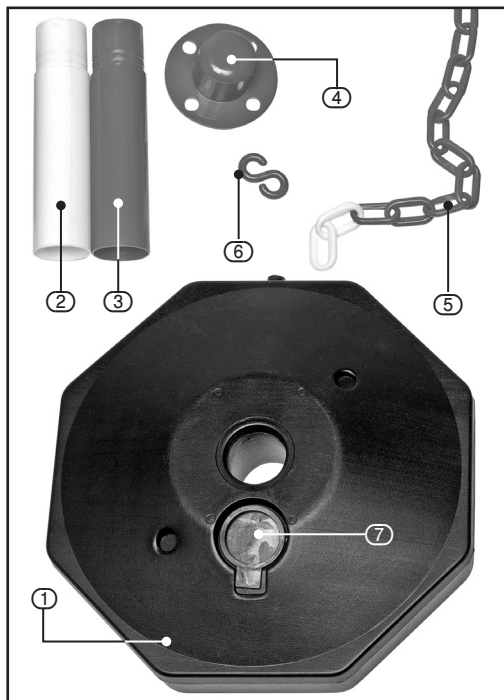

### 3. TECHNICAL DESCRIPTION

- ① 6 × Bases.
- ② 18 × Post sections (white).
- ③ 18 × Post sections (red).
- ④ 6 × Barrier chain connectors.
- ⑤ 25M Red and white chain.
- ⑥ 10 × 'S' Hooks.
- ⑦ Base filling cap.

### 4. ASSEMBLY

#### 4.1 ASSEMBLING THE POSTS – FIG1.

The six posts are made up of six connecting sections alternating in colour:

- Push fit the sections ② and ③ together using six sections of alternating red and white colours.

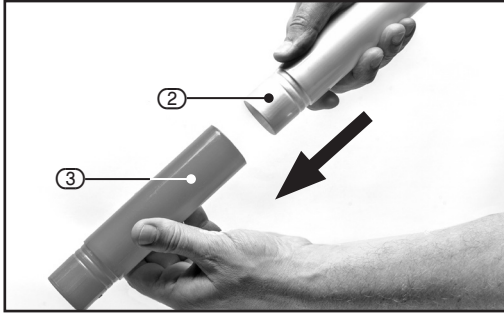

FIG. 1

#### 4.2 FITTING THE POSTS TO THE BASES – FIG2.

Attach the posts to the base sections ①:

- Insert a completed post into the hole in the base **through the underside of the base**. The post can only be inserted into the base this way.
- Slide the post along its full extent as far along as far as it will go until it locks into the base.

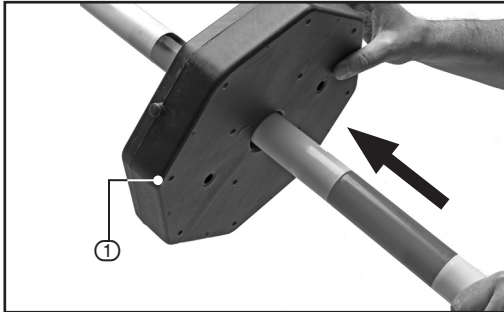

FIG. 2

#### 4.3 FITTING THE BARRIER CHAIN CONNECTORS – FIG. 3.

Slide a barrier chain connector cap ④ onto the end of each of the assembled six posts.

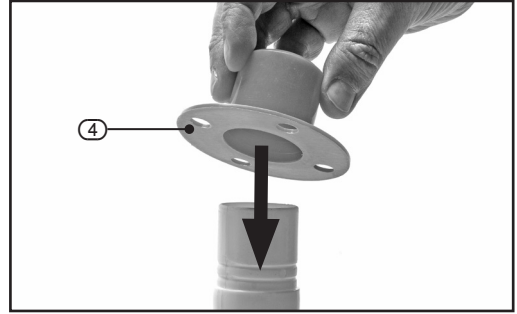

FIG. 3

#### 4.4 FITTING THE 'S' HOOKS TO THE BARRIER CHAIN CONNECTORS – FIG. 4.

The 'S' hooks ⑥ are used to connect the barrier chain to the posts.

- The hooks fit into any of the four holes located on the barrier chain connector cap ④.
- The four holes enable the exclusion zone kit to be set out in a variety of different sized areas and positions depending on the user's requirements.

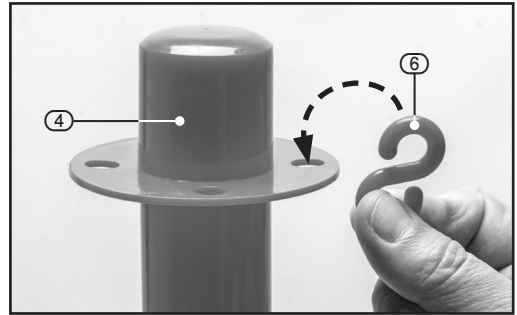

FIG. 4

## 4. ASSEMBLY

### 4.5 FITTING THE CHAIN – FIG. 5.

- Connect the barrier chain (5) to an 'S' hook (6) by threading the free end of the hook through the chain links.

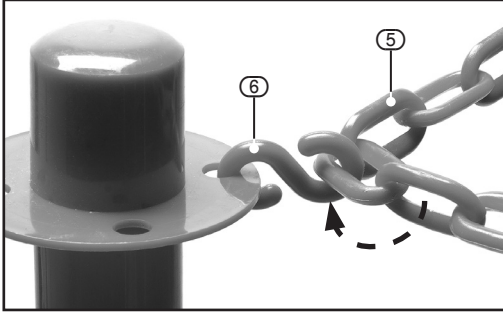

FIG. 5

### 4.6 STABILISING THE BASES – FIG. 6 – 7.

The base units need to be filled with either water or sand to ensure adequate stability when in use.

- Remove the filling cap (7) and fill the base.
- Ensure the cap is replaced tightly when full.

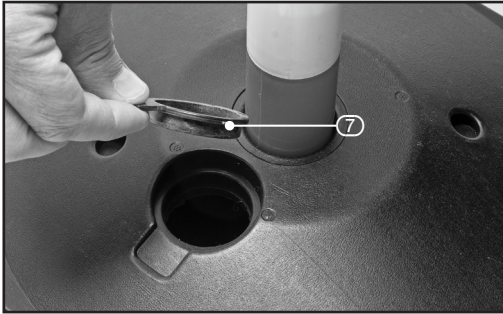

FIG. 6



FIG. 7

## CONTACTS

Draper Tools Limited, Hursley Road,  
Chandler's Ford, Eastleigh, Hampshire.  
SO53 1YF. U.K.

**Website:** drapertools.com

**email:** sales@drapertools.com

**Product Help Line:** +44 (0) 23 8049 4344

**Sales Desk:** +44 (0) 23 8049 4333

**General Enquiries:** +44 (0) 23 8026 6355

### Service/Warranty Repair Agent:

For aftersales servicing or warranty repairs, please contact the **Draper Tools Help Line** for details of an agent in your local area.

### YOUR DRAPER STOCKIST

DBCH0120

©Published by Draper Tools Limited.

No part of this publication may be reproduced, stored in a retrieval system or transmitted in any form or by any means, electronic, mechanical photocopying, recording or otherwise without prior permission in writing from Draper Tools Ltd.