

SENCOR®

SRV 9385WH



ROBOTIC VACUUM CLEANER

Translation of the original manual



SENCOR®

SRV 9385WH



A

1

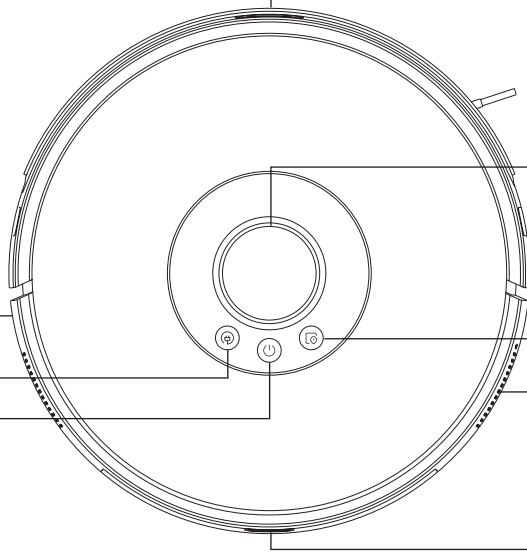

5

2

6

3

7

4

8

9

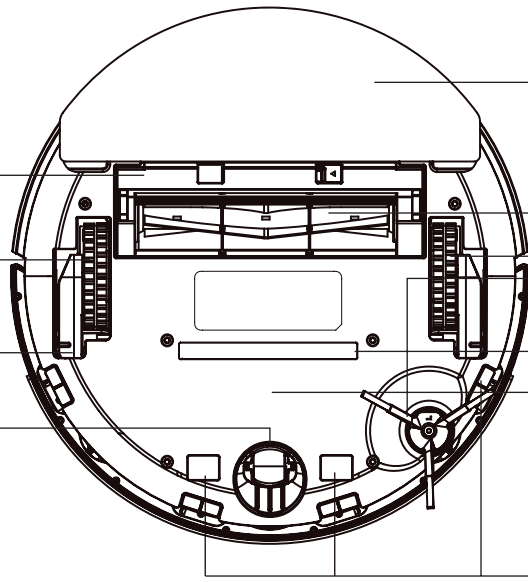

13

14

15

16

17

18

12

19

A

20

21

22

23

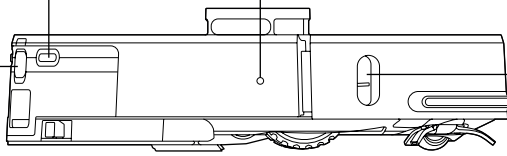

24

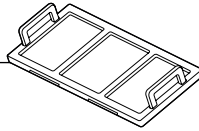

25

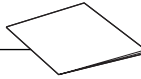

26

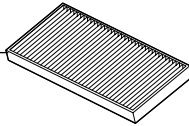

27

28

29

30

31

32

33

34

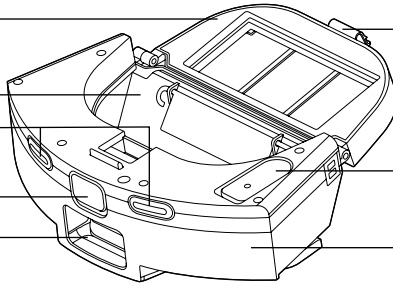

35

36

37

38

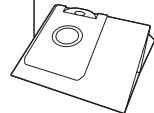
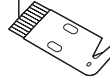
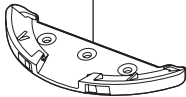

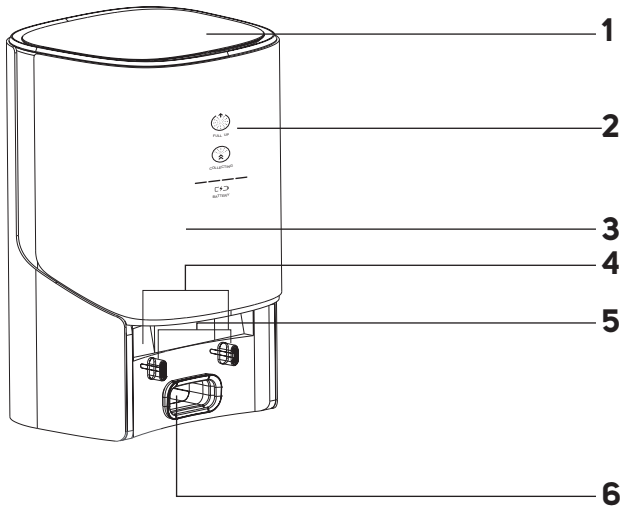
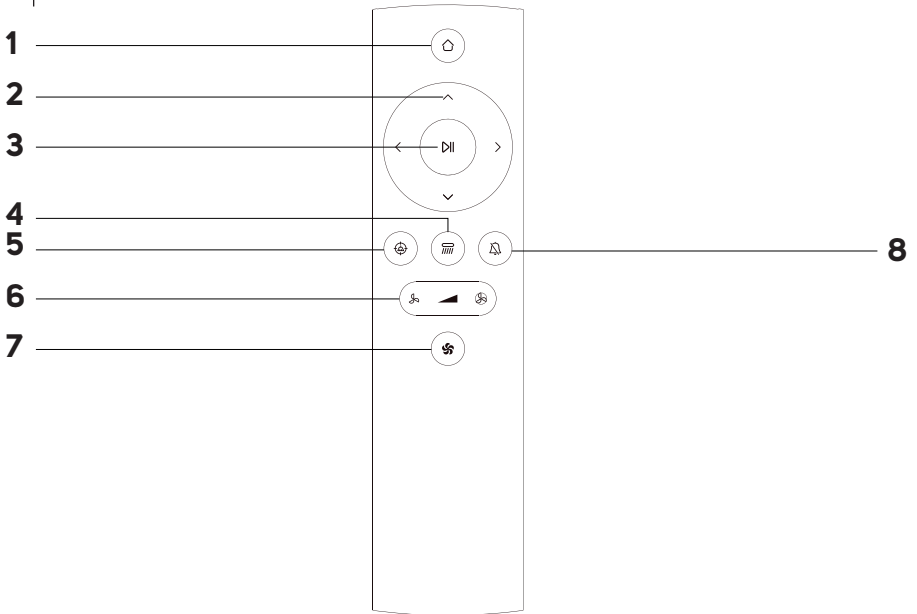
B**C**

D1

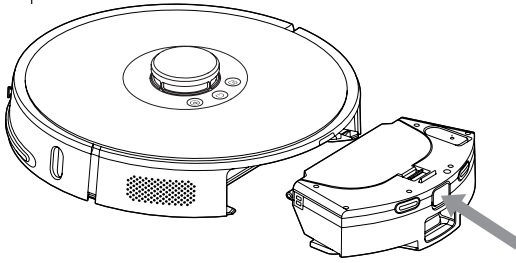

D2

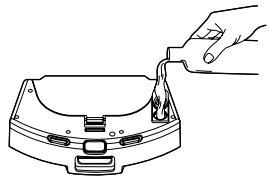

D3

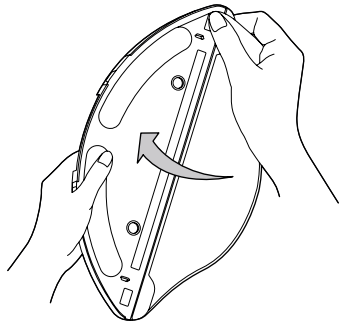

D4

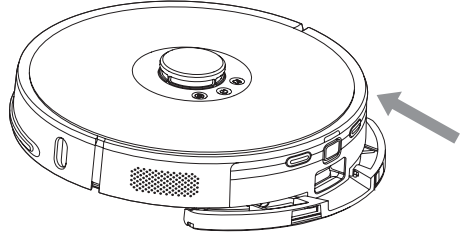

E

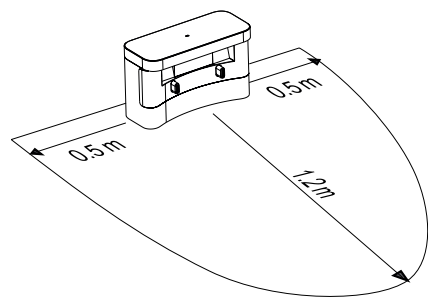

F1

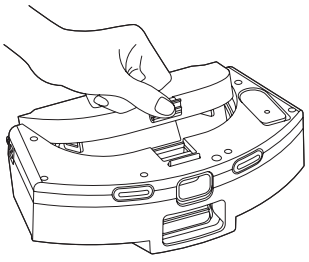

F2

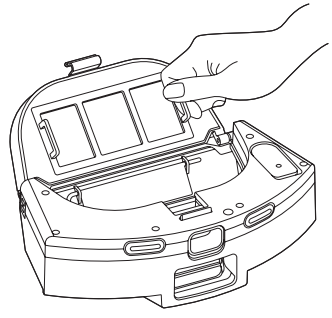

F3

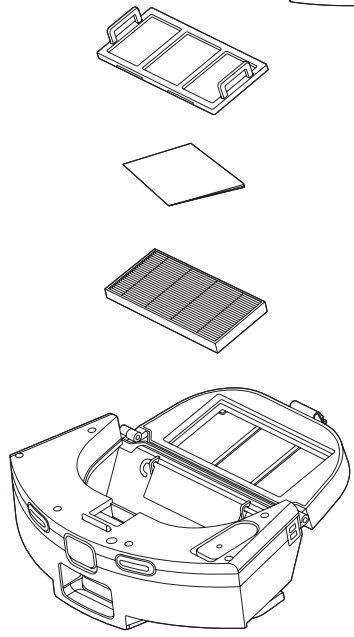

G1

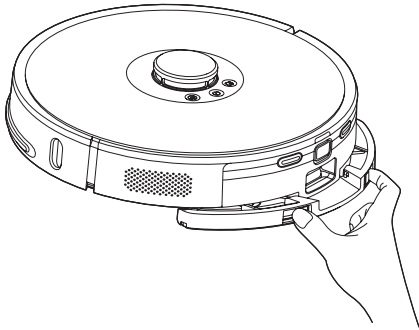

G2

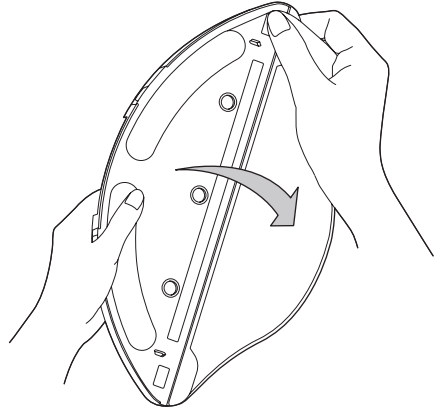

H1

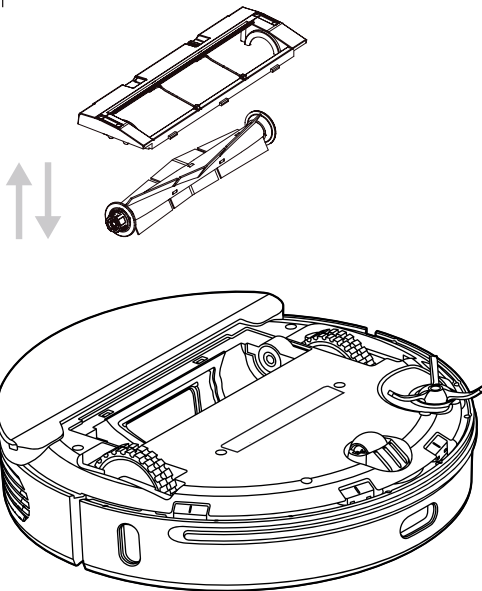

H2

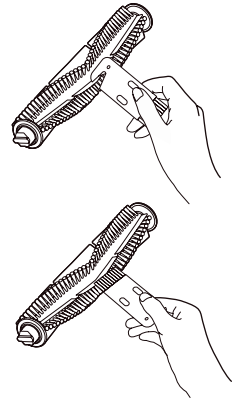

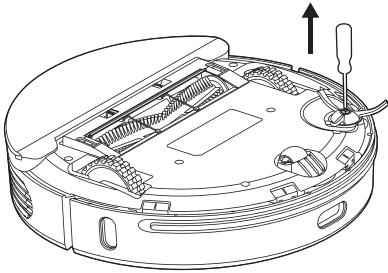
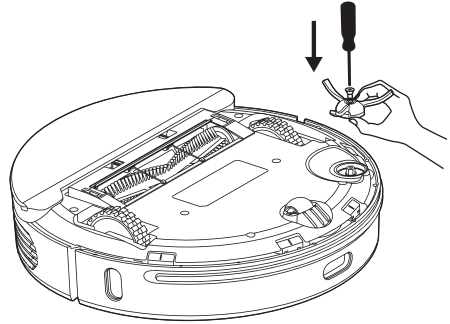
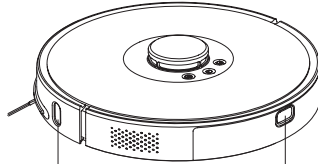
I1**I2****J**

4

2

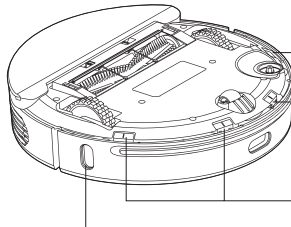

1

2

2

3

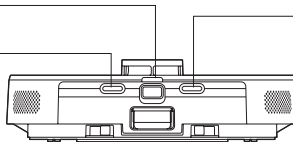

3

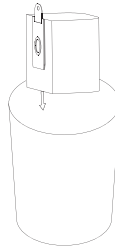
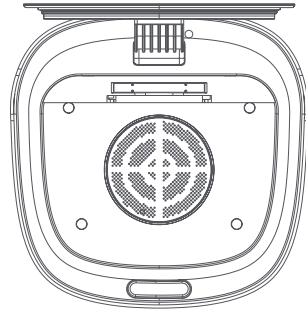
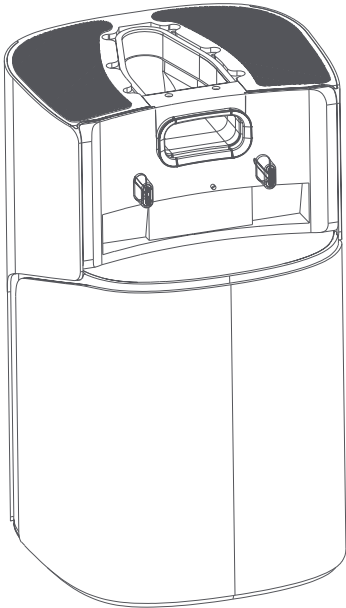
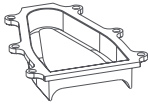
K1**K2****K3****L****M**

EN Robotic vacuum cleaner

Important safety instructions

READ CAREFULLY AND STORE FOR FUTURE USE.

- This appliance may be used by children 8 years of age and older and by persons with physical sensory or mental impairments or by inexperienced persons, if they are properly supervised or have been informed about how to use the product in a safe manner and understand the potential dangers.
- Children must not play with the appliance. Cleaning and maintenance performed by the user must not be performed by unsupervised children.



WARNING:

This appliance contains a UV-C light. Do not look into the light of the UV-C lamp and do not point the UV-C lamp at eyes.

- In the event that the power cable of the dust collection station is damaged, have it repaired at a professional service centre to prevent causing a dangerous situation. It is forbidden to use the appliance if it has a damaged power cord or dust collection station.
- Prior to cleaning or maintenance, always disconnect the appliance from the power socket and turn it off using the power switch.

- The appliance must only be used with the dust collection container that is supplied with the appliance.



WARNING:

Do not use the dust collection container for charging batteries or appliances that are not intended for it. The dust collection station is connected only to a power socket with a protective contact.

Electrical safety

- Before connecting the dust collection station to a power socket, check that the technical details on the rating label match the electrical voltage in the socket.
- Connect the dust collection station only to a properly grounded power socket. Do not use an extension cord.
- Do not disconnect the dust collection station from the power socket by pulling on the power cord. This could damage the plug or the socket. Disconnect the power cord from the power socket by pulling on the plug.
- Do not place the power cord over sharp objects. Make sure that the power cord does not hang over the edge of a table and that it is not touching a heated or hot surface.
- Keep the power cord dry.
- Do not connect and disconnect the power cord to and from the power socket with wet hands.
- Do not uncover the electronic parts of the robotic vacuum cleaner or its battery. They do not contain any components repairable by the user. Have the appliance serviced by qualified persons.
- To avoid any injury by electrical shock, do not spray the robotic vacuum cleaner, the power unit or the power adapter with water and do not submerge these in water or any other liquid.
- Do not use the robotic vacuum cleaner when it is not working correctly, if it has been damaged or has been submerged in water.
- To avoid the danger of injury by electrical shock, do not repair the robotic vacuum cleaner yourself or make any adjustments to it. Have all repairs performed at an authorised service centre. Tampering with the robotic vacuum cleaner during the warranty period may void the warranty.
- Prior to cleaning or maintenance, always disconnect the robotic vacuum cleaner from the power socket and turn it off using the power switch.

Safety during use

- This robotic vacuum cleaner is designed for use in households, offices and similar types of areas. Do not use it in industrial surroundings or outdoors.
- The robotic vacuum cleaner is not intended for vacuuming water and, therefore, must not be used in damp or wet areas, for example in laundries, bathrooms or around swimming pools. If it were to come into contact with water, the internal electronics of the vacuum cleaner would be destroyed.
- Do not use the robotic vacuum cleaner to vacuum the following items:
 - smouldering cigarettes, burning or flammable items, matches or ash;
 - water and other liquids;
 - sharp items, e.g. splinters, needles, pins, etc.;
 - flour, wall plaster and other building materials;
 - larger pieces of paper or plastic bags, which can easily block the suction hole.
- Do not expose the robotic vacuum cleaner to direct sunlight and do not place it near an open fire or appliances that are a source of heat.
- Do not use the robotic vacuum cleaner on narrow raised surfaces such as tables, wardrobes, etc. If the vacuum cleaner does not have sufficient space for manoeuvring, it may fall and be damaged.
- Only use the robotic vacuum cleaner with the original accessories from the manufacturer.
- Ensure that the robotic vacuum cleaner has a dust filter correctly installed in the dust container before use.
- Before putting the robotic vacuum cleaner into operation, check that the entry door into your apartment or house is closed. From the floor surfaces, remove clothing, paper, toys, power or extension cords and other items that the vacuum cleaner could suck in or catch. Lift curtains and drapes that reach to the floor so that they do not get caught in the vacuum cleaner.
- Do not place any items on to the robotic vacuum cleaner and do not step or sit on it.
- If the robotic vacuum cleaner is running, watch out for children and household pets.
- When the robotic vacuum cleaner is running, ensure that the air vents are not covered and that the suction hole is not blocked. Otherwise, the robotic vacuum cleaner may be damaged.
- Adhere to the instructions contained in this user's manual when performing cleaning and maintenance tasks.
- Do not push on the laser navigation module or attempt to lift its cover. This could damage the module.

Laser

- The laser sensor meets the laser safety class according to standard EN 60825-1.
- When using, handling or performing maintenance tasks on the robotic vacuum cleaner with a laser sensor, always adhere to the following instructions:
 - Prior to any handling, turn off the robotic vacuum cleaner using the power switch.
 - Do not point the laser beam at people.
 - Do not look into the direct or reflected beam of the laser.
 - Modifications or repairs of the laser sensor that are not performed by an authorised service centre are forbidden.

**Warning:**

Not following the instructions contained in this user's manual may result in dangerous irradiation!

- Thank you for purchasing a SENCOR brand product and we hope that you will be happy with it.
- Prior to using this appliance, please read the user's manual thoroughly, even in cases, when one has already familiarised themselves with previous use of similar types of appliances. Only use the appliance in the manner described in this user's manual. Keep this user's manual in a safe place where it can be easily retrieved for future use.
- We recommend saving the original cardboard box, packaging material, purchase receipt and responsibility statement of the vendor or warranty card for at least the duration of the legal liability for unsatisfactory performance or quality. In the event of transportation, we recommend that you pack the appliance in the original box from the manufacturer.







DESCRIPTION OF THE ROBOTIC VACUUM CLEANER

A1 Front infrared sensor	A19 Anti-fall sensors
A2 Bumper bar	A20 Charging contacts
A3 Charging button	A21 Dust container release button
A4 Button  (for turning on/off/ start the automatic cleaning)	A22 Reset button
A5 Laser navigation module	A23 Side infrared sensors
A6 Start local cleaning button	A24 Coarse filter
A7 Anti-collision strip	A25 Foam filter
A8 Rear infrared sensor	A26 HEPA filter
A9 Rotary brush cover	A27 Dust container lid
A10 Left travel wheel	A28 Dust container
A11 Anti-fall sensor	A29 Charging contacts
A12 Front swivel wheel	A30 Dust container release button 2-in-1
A13 Combination 2-in-1 dust container with water tank	A31 Dust container outlet
A14 Rotary brush	A32 Dust container lid lock
A15 Right travel wheel	A33 Water tank opening cover
A16 Side rotary brush	A34 Water tank
A17 UV light	A35 Mop sleeve holder
A18 Battery (located under the cover)	A36 Mop sleeve
	A37 Cleaning brush
	A38 Replacement dust bag

DESCRIPTION OF THE DUST COLLECTION STATION

B1 Lid of the dust collection station	compartment
B2 Display	B4 Infrared sensors
B3 Dust bag installation	B5 Charging contacts
	B6 Suction hole

DESCRIPTION OF THE REMOTE CONTROL

C1 Button  Return to the dust collection station	C5 Button  Intensive local cleaning
C2 Direction buttons for movement of the vacuum cleaner forward/back/left/right	C6 Suction power setting buttons
C3 Button  Start/stop cleaning	C7 Button  Maximum suction power
C4 Button  Start mopping mode	C8 Button  Mute voice messages

INCLUDED CONTENTS

- Robotic vacuum cleaner
- Dust collection station
- Remote control
- Mop sleeve holder
- Mop sleeve (3 pcs)

- HEPA filter (2 pcs: 1 pc installed on the vacuum cleaner; 1 pc spare HEPA filter)
- Side rotary brush (2 pcs: 1 pc installed on the vacuum cleaner; 1 pc spare side rotary brush)
- Dust bag (3 pcs)
- Cleaning brush
- Type AAA battery for remote control (2 pcs)

PURPOSE OF USE AND FEATURES OF THE ROBOTIC VACUUM CLEANER

- The robotic vacuum cleaner is intended for cleaning various types of hard floors such as wooden or laminate floating floors, tiles, vinyl, etc. and carpets with a low pile height. While vacuuming, it effectively combines various routes to optimally clean the entire floor area.
- The suction hole effectively removes hair, animal fur, etc. The side rotary brush brushes dirt out of hard-to-reach places along walls and furniture and out of corners. The motorised rubber wheels protect sensitive floors against scratching and can travel over threshold strips up to a height of 2 cm and ride on to a 2 cm high carpet.
- The suspended bumper enables the vacuum cleaner to dampen the approach to an obstacle and to efficiently clean around it. The infrared sensors in the front bumper prevent the robotic vacuum cleaner from colliding with obstacles. Safe operation in rooms with stairs is made possible by the bottom anti-stair-fall sensors.
- The remote control facilitates convenient control, enabling the vacuum cleaner to be turned on and off, to be set to the automatic cleaning mode, to select an operating mode or to send the robotic vacuum cleaner to the dust collection station.
- The vacuum cleaner is equipped with GYRO MAPPING function (orientation in space), which can identify the space geometry of a room in which it is cleaning, thereby the vacuum cleaner is able to better clean the floor. The vacuum cleaner is also equipped with laser navigation by means of which it maps out each room and then starts to clean it systematically. Both functions are built-in and cannot be affected in any way.

ROBOTIC VACUUM CLEANER CLEANING MODES

Automatic cleaning mode

- The robotic vacuum cleaner will effectively clean the maximum room area and when it has finished cleaning, it will return to the dust collection station.

Local cleaning mode

- The robotic vacuum cleaner will effectively clean an area of 1.6 x 1.6 m,

Other cleaning modes (e.g. cleaning a selected room, selected zone, etc.) can be set in the application.



Note:

Prior to starting the robotic vacuum cleaner, always check that it is fully charged and that all obstacles, foreign objects, cables, etc. have been removed from the area.

PREPARING THE ROBOTIC VACUUM CLEANER

- Take the robotic vacuum cleaner and all its accessories out of the packaging. Check that you have taken out all the parts.
- Check the robotic vacuum cleaner and its accessories for damage.
- Remove the protective film and advertising labels from the robotic vacuum cleaner and all the accessories.

Installing the side rotary brush

- The side rotary brush is intended for smooth floor surfaces and ensures effective cleaning in corners, along walls and furniture.
- Turn the vacuum cleaner upside down. Put the rotary brush on to the pin that is intended for it and secure it in place with a screw using a screwdriver. Turn the vacuum cleaner back over.
- When using the vacuum cleaner to clean rooms with carpets, remove the rotary brush. To remove it, proceed in the reverse sequence.

COMBINATION 2-IN-1 DUST CONTAINER WITH WATER TANK

- The combination dust container with water tank enables the floor to be vacuumed and wiped at the same time. The robotic vacuum cleaner vacuums dirt and dust from the floor and then wipes it. Depending on the intended use of the robotic vacuum cleaner, it is necessary to pour water into the water tank and to attach the holder with the mop sleeve.

Using the robotic vacuum cleaner only for vacuuming

1. When using the robotic vacuum cleaner only for vacuuming, before using it, ensure that the dust container is inserted in the vacuum cleaner and that it is empty.
2. In order to be able to remove the dust container, press the dust container release button and pull the dust container out of the vacuum cleaner – see figure **D1**.
3. Insert the dust container into the robotic vacuum cleaner so that the dust container lid is pointing upwards and the outlet is point outwards – see figure **D1**. Gently push down on the dust container from behind until you hear a click. This indicates that the dust container is correctly secured in the vacuum cleaner.

Using the robotic vacuum cleaner for vacuuming and wiping the floor

- In order to use the robotic vacuum cleaner for vacuuming and wiping the floor at the same time, it is necessary to put water into the water tank and to attach the holder with the mop sleeve on to the bottom side of the container.

1. Remove the dust container from the robotic vacuum cleaner by pressing the dust container release button and pull the dust container out of the vacuum cleaner – see figure **D1**.
2. Release the water tank cover and pour water into the water tank through the opening – see figure **D2**.



Note:

For wiping, we recommend using clean water. If you use a cleaning agent, it may foam up and thereby worsen the dripping of the water on to the sleeve, or potentially cause smudges on the floor after it dries.

3. Firmly close the lid and insert it into the robotic vacuum cleaner so that the dust container lid is pointing upwards and the outlet is pointing outwards – see figure **D1**. Gently push down on the dust container from behind until you hear a click. This indicates that the dust container is correctly secured in the vacuum cleaner.
4. Put the mop sleeve on to the holder – see figure **D3**. We recommend soaking and rinsing out the sleeve slightly before putting it on. This speeds up the soaking process and subsequent wiping of the floor.
5. Insert the holder with the mop sleeve under the container so that the cut-out in the holder slides in underneath the container – see figure **D4**. Gently push down on the holder towards the rear until you hear a click. This indicates that the holder with the mop sleeve is correctly secured in the vacuum cleaner.



Warning:

Do not use the robotic vacuum cleaner to vacuum and wipe door mats, runners, etc. Before vacuuming carpets, it is necessary to remove the holder with the mop sleeve.

LOCATION OF THE DUST COLLECTION STATION

- The dust collection station serves to automatically recharge the battery and the vacuum cleaner must have good access to it.
- Locate the dust collection station against a wall on a hard, horizontal and dry surface within reach of a power socket – see figure **E**. Make sure that there are no stairs or obstacles within a distance of 0.5 m

on the left and right of the charging station and within a distance of 1.2 m in front of the dust collection station, that would prevent the vacuum cleaner from finding the dust collection station and docking successfully.

- Connect the power cord of the dust collection station to a power socket. Locate it in such a way that it does not tangle into the rotary brushes of the vacuum cleaner.
- In the event that the vacuum cleaner is not used for an extended period of time, disconnect the dust collection station from the power socket and store it in a dry, clean and cool place.

CHARGING THE ROBOTIC VACUUM CLEANER

- The vacuum cleaner can be charged in the dust collection station, which the vacuum cleaner automatically seeks out when it has finished cleaning.
- Always check that the vacuum cleaner is turned on with the  button.

Charging the vacuum cleaner for the first time

- Before first use, it is necessary to fully charge the robotic vacuum cleaner. Allow the robotic vacuum cleaner to charge for up to 12 hours.
- Grasp the vacuum cleaner and manually place it into the dust collection station so that the charging contacts on the underside of the vacuum cleaner and the charging contacts on the dust collection station are connected. When the contacts are connected, the charging process will start.





Automatic charging

- The robotic vacuum cleaner utilises the automatic charging function whenever it finishes cleaning and in cases, where during operation, it detects low power on the battery. Therefore, the robotic vacuum cleaner will start to actively seek out the dust collection station. It is thus important that it is always connected to a power source and is freely accessible for the vacuum cleaner so that it can dock in it.
- The robotic vacuum cleaner can be sent to be charged also by pressing the charging button directly on the vacuum cleaner, in the application or on the remote control. In such a case, the operation of the robotic vacuum cleaner will stop and it will seek out the dust collection station.
- After docking in the dust collection station, the charging cycle will commence. A complete charge takes approximately 4 to 6 hours. The actual charging time depends on the power level of the battery at the start of the charging process.
- A full charge will provide up to 200 minutes of operation (with the low suction power set).
- In the event that the charging contacts are disconnected during the charging cycle, the vacuum cleaner will move away from the dust collection station and then re-dock itself to resume the charging process, unless it is prevented from doing so by an obstacle.
- In the event of a power outage, the charging cycle will be interrupted and will continue after the power supply is renewed.
- In the event that the maximum charging current is exceeded, the charging process will be automatically interrupted.
- In the event that the robotic vacuum cleaner is discharged completely, e.g. because the vacuum cleaner failed to seek out or dock in the dust collection station, it is necessary to put it there manually.

CONTROLLING THE VACUUM CLEANER USING ITS BUTTONS

- The buttons on the vacuum cleaner are used for basic controls. For more advanced controls, use the remote control or control your robotic vacuum cleaner via the mobile application. You will find more information further in the user's manual.

Turning the robotic vacuum cleaner on/off

- Press and hold down the  button for 3 seconds to turn on the robotic vacuum cleaner. The  button will start flashing white. The robotic vacuum cleaner will switch to the stand-by mode.
- Press and hold down the  button for 3 seconds to turn off the robotic vacuum cleaner. The  button will start flashing white for

a while and then it will turn off. The robotic vacuum cleaner is turned off.



Note:

It is not possible to turn off the robotic vacuum cleaner during the charging process.

Pausing the cleaning process

- If the button is pressed during the operation of the robotic vacuum cleaner then the operation of the robotic vacuum cleaner will be paused. Pressing the button again will resume its operation.

Sleep mode

- After 60 seconds of inactivity, the robotic vacuum cleaner will switch to sleep mode. Pressing any button will switch the robotic vacuum cleaner to stand-by mode.

Selecting the cleaning mode

- While the robotic vacuum cleaner is in stand-by mode, press the button and the robotic vacuum cleaner will start automatic cleaning.
- While the robotic vacuum cleaner is in stand-by mode, press and hold down the charging button and the robotic vacuum cleaner will start local cleaning.

Charging

- Press the charging button if you need to send the robotic vacuum cleaner for charging. This will end the currently running cleaning process and the vacuum cleaner will start seeking out the dust collection station, where it will dock.

CONTROLLING THE VACUUM CLEANER USING THE REMOTE CONTROL

- Push down the latch of the cover on the rear side of the remote control to release it and remove the cover.
- Insert two type AAA (1.5 V) batteries into the remote control. When inserting the batteries ensure the correct polarity as shown inside the battery compartment. Put the cover back on and click it into place.
- In the event that the batteries are flat, replace them with new ones. Do not combine various types of batteries or new and old batteries.
- The signal range of the remote control is approximately 6 m.
- When replacing batteries, first remove the flat batteries and then insert the new ones.



Note:

Never combine flat and new batteries nor various types of batteries.

Starting cleaning

- Press the button to start automatic cleaning. The robotic vacuum cleaner will start.
- Press the button to start local cleaning.
- While the vacuum cleaner is running, pressing the button will stop its operation. Resume operation by pressing the button again.
- If you need to end the cleaning, press the button, the robotic vacuum cleaner will stop, end the cleaning process, seek out the dust collection station and dock in it.

Starting mopping

- Ensure that the holder with the mop sleeve is attached to the vacuum cleaner and that there is water in the water tank.
- Press the button to activate the mopping mode. In this mode, the suction power is automatically reduced to minimum.
- Pressing the button again will cancel the mopping mode.

Setting the suction power

- Set the suction power based on the type of floor covering and the degree of soiling.

- Repeatedly pressing the button will reduce the suction power, repeatedly pressing the will increase the suction power.
- If you need to set the maximum suction power, press the button.

Movement of the robotic vacuum cleaner

- The direction buttons serve to manually control the movement of the robotic vacuum cleaner. However, it is necessary that the robotic vacuum cleaner is in operation.
- The button is used to move it forward.
- The button is used to turn the robotic vacuum cleaner around by 180°.
- The button is used to turn the robotic vacuum cleaner 90° to the left and for movement to the left.
- The button is used to turn the robotic vacuum cleaner 90° to the right and for movement to the right.

Muting the voice messages

- Press the button to immediately mute the voice messages. Pressing the button again will resume the voice messages.

Controlling the vacuum cleaner using the mobile application

- The robotic vacuum cleaner can be controlled via the Sencor HOME application.
- Download the application to your smart phone, register yourself and control the robotic vacuum cleaner via the application.



- If you already have the application installed, add the robotic vacuum cleaner to your devices.



Adding the robotic vacuum cleaner to the device list via a QR code

- The robotic vacuum cleaner can also be added to the Sencor HOME application using the QR code provided below. On the home screen of the application, click on the "+" icon and on the Add device screen, click on the [-] icon in the top right hand corner.
- After scanning the QR code, you will be asked to select a Wi-Fi network. Select a network, enter the password and click on "Next".
- You will be asked to reset the device. Press and hold down the and buttons for 3 seconds. The vacuum cleaner will beep and the white backlight will start flashing. This means that the robotic vacuum cleaner is ready for pairing. You will also find instructions on the screen of the application.
- In the application, confirm that the (Wi-Fi) indicator is flashing and click on "Next".
- Click on "Connect". Then in the Wi-Fi settings on your mobile device connect the Wi-Fi to the robotic vacuum cleaner. Then return to the application and wait until the pairing of the robotic vacuum cleaner is complete.
- In the device list on the main screen, click on the icon of the robotic vacuum cleaner to enter control interface.



QR code for adding the control panel of the robotic vacuum cleaner to the application Sencor HOME



Manually adding the robotic vacuum cleaner to the device list

- On the main screen, click on "Add device" or on the "+" in the top right hand corner and here click on "Add device".
- A screen with appliance categories will appear together with a list of appliances.
- Click on "Robotic vacuum cleaners" and from the list, select the robotic vacuum cleaner model.
- On the next screen, you will be asked to select a Wi-Fi network. Select a network, enter the password and click on "Next".
- You will be asked to reset the device. Press and hold down the  and  buttons for 3 seconds. The vacuum cleaner will beep and the white backlight will start flashing. This means that the robotic vacuum cleaner is ready for pairing. You will also find instructions on the screen of the application.
- In the application, confirm that the (Wi-Fi) indicator is flashing and click on "Next".
- Click on "Connect". Then in the Wi-Fi settings on your mobile device connect the Wi-Fi to the robotic vacuum cleaner. Then return to the application and wait until the pairing of the robotic vacuum cleaner is complete.
- In the device list on the main screen, click on the icon of the robotic vacuum cleaner to enter control interface.

Wi-Fi reset

- Press and hold down the  and  buttons for 3 seconds. The vacuum cleaner will beep and the white backlight will start flashing slowly.





Note:

We recommend that you turn off mobile data in your mobile telephone's settings during the Wi-Fi connection.

DUST COLLECTION STATION

- The dust collection station is equipped with a dust bag, into which the robotic vacuum cleaner dumps the contents of its dust container after it has finished cleaning or if it registers that the dust container is full. When this happens, the robotic vacuum cleaner will seek out the dust collection station and reverse towards it so that the opening in the dust container aligns with the suction hole on the underside of the dust collection station. Upon contact, both openings will open and the contents of the dust container will be, by means of pressure, sucked into the dust bag. Then the openings will close and the robotic vacuum cleaner will start to recharge or it will continue in the cleaning process.
- To ensure the correct operation of the dust collection station, make sure that it is connected to the power socket.

Icons on the display of the dust collection station and their meanings

Icon	Status	Meaning
 FULL UP	Lit. Flashing.	The dust bag is full. It is necessary to replace it. The dust bag is not inserted or not inserted correctly. Insert the dust bag correctly.
 COLLECTING	Icon is flashing white.	The contents of the dust container are being sucked out.
 BATTERY	Charging indicators are flashing.	After the vacuum cleaner returns to the dust collection station, the charging indicators flash for a few seconds.



Note:

If all the icons on the display are lit and flashing, then this indicates a fault on the motor fan. Contact an authorised service centre.

CLEANING AND MAINTENANCE

- Prior to cleaning it, always turn off the vacuum cleaner using the  button.

- For cleaning, never use abrasive cleaning products, solvents, etc.
- Neglecting cleaning and maintenance may negatively affect the working order of the vacuum cleaner and lead to its reduced performance.

ROBOTIC VACUUM CLEANER

Emptying the dust container

- On the SRV 9385WH model, the container is automatically emptied into the dust collection container both after every use and also during the cleaning process when the vacuum cleaner detects the maximum amount of dirt and dust in the container. It is possible to set how frequently the dust container will be emptied out.

Cleaning the dust container

- In order to be able to remove the dust container, press the dust container release button and pull the dust container out of the vacuum cleaner – see figures **D1**.
- Press the dust container lid lock and tilt open the dust container lid – see figure **F1**.
- Press the coarse filter clip – see figure **F2**. Take the coarse filter, foam filter and the HEPA filter out of the lid – see figure **F3**.
- Tap out the HEPA filter and the foam filter and remove the dirt and dust from them using a fine brush or soft wiping cloth. In the event of heavy soiling, you can vacuum them out using a different vacuum cleaner with an attached brush nozzle. Do not wash the HEPA filter in water. This could damage it. In the event that the HEPA filter is already heavily soiled or deformed, replace it with a new one. We recommend replacing the HEPA filter based on the frequency of use at least once every six months.
- Rinse the coarse filter under running water and wipe dry with a clean wiping cloth.
- Wipe the dust container out using a lightly dampened sponge and wipe dry using a clean wiping cloth. If necessary, you can pour a small amount of water into the dust container and wipe it out with a sponge. Then thoroughly wipe it dry using a clean wiping cloth.
- Insert the HEPA filter, the foam filter and then the coarse filter into the area in the lid. Gently push down on the coarse filter until you hear a click. This indicates that the coarse filter is properly secured in place.
- Close the dust container lid. Gently push down on the lid until you hear a click. This indicates that the lid is properly closed.



Warning:

Prior to inserting the filter into the dust container and closing the lid, always ensure that all the parts are clean and completely dry. Otherwise, there is a risk of damaging the robotic vacuum cleaner.

Cleaning the water tank and mop sleeve

- To prevent the formation of moulds and damaging microorganisms that may cause unpleasant odours and be damaging to health, it is necessary to clean the water tank, mop sleeve holder and the mop sleeve after every use.
- Press the clip on the mop sleeve holder and pull it out of the bottom part of the robotic vacuum cleaner – see figure **G1**.
 - Carefully remove the mop sleeve from the holder – see figure **G2**.
 - In order to be able to remove the dust container, press the dust container release button and pull the dust container out of the vacuum cleaner – see figure **D1**.
 - Take the dust container over a wash basin or sink and release the water tank cover. Turn the container upside down and allow the water remaining in the water tank to flow out. If necessary, gently shake the water tank to ensure that all the water has flowed out.
 - Leave the water tank cover open and allow the water tank to dry out in a dry and well ventilated location.
 - Wipe the mop sleeve holder using a lightly dampened sponge and wipe dry using a clean wiping cloth.
 - Hand wash the mop sleeve in lukewarm water with a small amount of fine washing powder, wring it out by hand and allow it to dry naturally. Do not wash the mop sleeve in a washing machine or dry it in a clothes dryer.

Cleaning the central rotary brush

- We recommend that you regularly clean the central rotary brush, at least once per week, to ensure the constant suction power of the robotic vacuum cleaner. Hair and fur that is wound on to the brush may reduce the output power output of the robotic vacuum cleaner and also its effectiveness.
1. Turn the robotic vacuum cleaner upside down.
 2. Press the clip of the central rotary brush cover and take the cover off the vacuum cleaner and then take out the rotary brush – see figure **H1**.
 3. Use a dry wiping cloth to clean out the area in which the rotary brush is housed. Check and clean out the suction hole. Dirt and dust that accumulates around the suction hole may reduce the suction power of the vacuum cleaner.
 4. Remove any dirt and material (dust, wound on hair, animal fur, etc.) from the rotary brush – see picture **H2**.
 5. Insert the rotary brush back into the vacuum cleaner and put on the cover. Gently push down on the cover until you hear a click. This indicates that the cover is properly secured in place.

Cleaning the side rotary brush

1. Loosen the screw of the side rotary brush using a screwdriver – see figure **I1**.
2. Take the side rotary brush out of the vacuum cleaner by pulling it upwards.
3. Remove any dust and dirt from the location where the brush was mounted.
4. Remove all dust and dirt from the brush. If necessary you may wash the brush under running water. If the bristles were deformed while the vacuum cleaner was running, dip them in warm water to allow them to return to their original shape. Allow the brushes to dry before reattaching to the vacuum cleaner.
5. Insert the side rotary brush into the robotic vacuum cleaner and secure it in place using the screw – see figure **I2**.

Cleaning the sensors

- The sensors on the robotic vacuum cleaner are important for its proper control and safe operation. It is, therefore, important that you regularly clean them and maintain them in good condition.
- The robotic vacuum cleaner includes a total of (see figure **J**):
 1. 4 anti-fall sensors (on the underside of the robotic vacuum cleaner)
 2. 3 infrared sensors
 3. 2 charging contacts
 4. infrared side sensors
- Wipe the sensors using a soft dry wiping cloth or cotton bud.

Cleaning the outer surface of the robotic vacuum cleaner

- Regularly wipe the surface of the vacuum cleaner using a soft dry wiping cloth.
- Clean the front swivel wheel, motorised wheels, suction hole, rotary brush and the bottom sensors at least once per week or more frequently.
- First remove any coarser dirt from the front swivel wheel and the motorised wheels. Then clean them around their entire perimeter using a lightly dampened cloth and wipe them dry. Do not forget to also clean the area around the wheels.

Replacing the HEPA and foam filter

1. Take out the dust container and open the dust container lid. Take out the coarse filter, old foam filter and old HEPA filter.
2. Insert a new HEPA filter, a new foam filter and then the coarse filter into the area in the lid. Gently push down on the coarse filter until you hear a click. This indicates that the coarse filter is properly secured in place.
3. Close the dust container lid. Gently push down on the lid until you hear a click. This indicates that the lid is properly closed.



Note:

The wear and tear status of the HEPA filter can be monitored in the mobile application.



Note:

The HEPA and foam filters are always replaced at the same time.

Replacing the side brush

- The rotary brushes become worn out when used. After a certain time it is necessary to replace the used brushes with new ones. To order a new brush, please contact your vendor or an authorised service centre. The wear and tear status can be monitored in the mobile application.
1. Loosen the screw of the side rotary brush using a screwdriver.
 2. Take the old side rotary brush out of the vacuum cleaner by pulling it upwards.
 3. Insert a new side rotary brush into the robotic vacuum cleaner and secure it in place using the screw.

DUST COLLECTION STATION

Cleaning the dust collection station

- Wipe the outer surface of the dust collection station using a soft, dry wiping cloth.

Replacing the dust bag

- If the dust bag is full, the  icon will appear on the display of the dust collection station. It is necessary to replace the dust bag. To replace it, proceed as follows:
 1. Disconnect the dust collection station from the power socket.
 2. Open the lid of the dust collection station – see figure **K1**.
 3. Grasp the dust bag holder and carefully pull it upwards – see figure **K2**. This will close the inlet hole to the dust bag, ensuring that dust and dirt remains safely enclosed in the dust bag.
 4. Throw the used dust bag out with standard communal waste.
 5. Insert a new dust bag into the dust collection container – see figure **K3**. It is important that the inlet hole in the bag is aligned with the outlet hole in the internal area of the collection container.
 6. Close the lid.

Cleaning the inlet suction hole of the dust collection station

- In the event that, after replacing the dust bag, all the icons on the display start to flash, it is necessary to check whether the inlet suction hole of the dust collection station is clogged.
 1. Make sure that the dust collection station is disconnected from the power socket.
 2. Turn the dust collection station upside down.
 3. Remove the cover of the inlet suction hole – see figure **L**.
 4. Eliminate the cause of the blockage, dirt and dust.
 5. Put on the cover and turn the dust collection station back over to the operating position.

Cleaning the sensors

- The sensors on the dust collection station are important for its operation. It is, therefore, important that you regularly clean them and maintain them in good condition.
- Wipe the infrared sensors and the charging contacts using a soft dry wiping cloth or cotton bud.

Cleaning the fan filter

- The fan filter is located inside the dust collection station underneath the dust bag – see figure **M**. When replacing the dust bag, check the condition of the filter and if necessary remove any dirt and dust using a soft, dry sponge. We recommend cleaning the fan filter once per month.

REPLACING THE BATTERY

- Model number of a replacement battery: SRX 9301
- In the event that you need to replace the battery, proceed as follows:
 1. Make sure that the vacuum cleaner is turned off using the  button. Turn the vacuum cleaner upside down.
 2. Using a screwdriver, loosen the screws (8 in total) of the bottom cover, remove them and carefully remove the bottom cover.
 3. Disconnect the connector of the battery and take the battery out of the internal area of the vacuum cleaner.
 4. Connect the new battery and insert it into the internal area. The battery can only be connected in one way. The connector is coded and cannot be turned around.

5. Put on the bottom cover and secure it in place using the screws. Turn the vacuum cleaner back to the operating position.
6. Place the vacuum cleaner into the dust collection station and allow the battery to charge to full capacity.



Note:

The robotic vacuum cleaner is supplied with the battery already inserted.

LONG TERM STORAGE

- When not using the vacuum cleaner for an extended period of time, do the following:
- Clean the vacuum cleaner as described in chapter CLEANING AND MAINTENANCE.
- Disconnect the dust collection station from the power socket. Store the vacuum cleaner with all its accessories in a dry, clean and cool place.
- It is recommended to charge the vacuum cleaner every 3 months as this will extend the lifetime of the built-in battery.
- Remove the batteries from the remote control.

TROUBLESHOOTING

Problem	Cause	Solution
The vacuum cleaner is not charging itself.	The charging contacts are not touching.	Check that the contacts are touching when inserting the vacuum cleaner into the dust collection station.
	The dust collection station is disconnected from the power source.	Connect the power cord to the power socket and leave the dust collection station permanently connected.
The vacuum cleaner is stuck in a single location.	The vacuum cleaner has become entangled in wires/cables lying on the ground, in curtains or other foreign objects on the carpet.	The vacuum cleaner will always attempt to free itself on its own, however, we recommend to remove it by hand from the stuck location.
The vacuum cleaner has returned to the dust collection station without completing the cleaning process.	The vacuum cleaner detected a low battery charge level and automatically returned to the station to recharge.	This is normal. Allow the vacuum cleaner to recharge.
The vacuum cleaner does not perform the cleaning process automatically as scheduled.	The vacuum cleaner is not switched on and cannot perform the cleaning process as scheduled.	Turn on the vacuum cleaner.
	The vacuum cleaner battery is almost flat.	Allow the vacuum cleaner to recharge.
	The vacuum cleaner has become stuck or is blocked by a foreign object.	Turn off the vacuum cleaner, empty out the dust container. Turn the vacuum cleaner upside down and remove dust and dirt from the wheels and brushes.

The remote control doesn't work. (Recommended distance is 5 m.)	Batteries are flat.	Replace the batteries in the remote control.
	The vacuum cleaner battery is almost flat.	Allow the vacuum cleaner to recharge.
	The remote signal receiver on the vacuum cleaner or the signal transmitter on the remote control is blocked or soiled.	Wipe the signal receiver and transmitter using a clean wiping cloth.
Whilst the vacuum cleaner is running, vacuuming locations are being left out, its travel path is chaotic, it is travelling in the opposite direction, the map in the application is showing inaccuracies or is not defined.	The remote control signal is being interfered with by another device in its vicinity.	Do not use the remote control in the vicinity of devices with an infrared signal.
	The floor is too smooth, the central wheel slides on the floor and the vacuum cleaner travels over low obstacles, thresholds and strips, and this affects its decision making process regarding the cleaning area in the entire home.	We recommend closing the doors of individual rooms and a to allow them to be cleaned individually. The vacuum cleaner is equipped with a function for the identification of a single room. It will return to its starting location.
	The floor is washed and polished or too smooth, which reduces friction between the wheels and the floor.	We recommend cleaning the floor after it has been waxed.
Dirt remains on the floor after cleaning is finished.	Cables, foreign objects on the floor affect the operation of the vacuum cleaner.	Prior to starting the vacuum cleaner, it is important to remove from the floor any cables, slippers, toys and other foreign objects to reduce the number of obstacles, which the vacuum cleaner will need to drive around.
	The central rotary brush is blocked.	Clean out the central rotary brush and move the robotic vacuum cleaner into an open area.
	The side rotary brush is blocked.	Clean out the side rotary brush and move the robotic vacuum cleaner into an open area.
It is not possible to turn on the vacuum cleaner.	The 2-in-1 combination dust container is not correctly inserted in the robotic vacuum cleaner.	Insert the 2-in-1 combination dust container into the robotic vacuum cleaner.
	The dust container is full, the HEPA filter is clogged or the central rotary brush is dirty.	Empty out the dust container, clean the HEPA filter and the central rotary brush.
	The battery is flat.	Allow the battery to fully recharge.
The vacuum cleaner has problems with movement on the floor.	Front swivel wheel is blocked.	Clean out the front swivel wheel and move the robotic vacuum cleaner into an open area.
The vacuum cleaner will seek out the dust collection station but does not dock in it.	The dust collection station is blocked or is too far away, it is not connected to a power source; foreign objects are caught on the mop sleeve holder or the mop sleeve is rolled up.	Place the dust collection station into an open area and place the robotic vacuum cleaner into its vicinity and turn it on; insert the plug into a power socket; clean out the mop sleeve holder and straighten out the mop sleeve.



The vacuum cleaner is not behaving normally.	Internal fault.	Turn off the robotic vacuum cleaner and then turn it on again and start it. If the problem persists, turn off the vacuum cleaner and contact an authorised service centre.
Abnormal sounds are made during the cleaning process.	A foreign object has become stuck to the central rotary brush, side rotary brush or on the central swivel wheel.	Turn off the robotic vacuum cleaner and remove the foreign object.
The water tank does not release water into the sleeve or is only releasing a small amount of water.	There is an insufficient amount of water in the water tank; the sleeve is excessively soiled; the holder is not inserted.	Refill the water tank with water; clean the sleeve; correctly insert the mop sleeve holder.
The water tank is releasing too much water.	The water tank is not in its place; the water outlet is set to maximum.	Check that the water tank is properly inserted; adjust the water outlet using the application.
It is not possible to connect to the application.	Abnormal Wi-Fi network, incorrect Wi-Fi password or abnormal behaviour of the application.	Check whether the robotic vacuum cleaner is within range of the Wi-Fi network; enter the correct password or reset the Wi-Fi; download and install the latest version of the application.
The vacuum cleaner is not able to return to the dust collection station after intensive cleaning or after movement.	The robotic vacuum cleaner is creating a new map for itself or the distance is too great.	After intensive cleaning or movement of greater distances, the robotic vacuum cleaner will generate a new map for itself. If the dust collection station is too far away, it is possible that the robotic vacuum cleaner will not be able to find it. Put the robotic vacuum cleaner into the dust collection station manually.



Note:

In the event that the problem is not listed in the table or continues to persist, stop using the appliance and contact an authorised service centre.

TECHNICAL SPECIFICATIONS

Robotic vacuum cleaner

Power input of the robotic vacuum cleaner.....	24 V 1.2 A
Rated power.....	50 W
Battery.....	Li-ion / 24 V / 5 000 mAh
Dimensions (diameter x height).....	349 x 100 x 353 mm
Weight.....	7.8 kg
Operating time per single charge.....	200 min
Dust container capacity	350 ml
Water tank capacity	250 ml
Laser sensor class	I

Dust collection station

Input voltage.....	220–240 V ~
Input frequency.....	50–60 Hz
Output voltage.....	24 V
Output current.....	1.2 A
Rated power.....	950 W
Average efficiency in the active mode.....	90 %
Dimensions.....	250 x 210 x 350 mm

Changes to text and technical parameters reserved.

Original consumable accessories

SRX 9304	HEPA filter
SRX 9305	Side rotary brush
SRX 9302	Mop sleeve
SRX 9309	Dust bag

BATTERY DISPOSAL



Prior to disposing of the product or handing it over at a specialised collection facility, it is necessary to ensure that the battery is removed. Before removing the battery, it is necessary to start the vacuum cleaner and wait until it is completely flat. The battery contains environmentally damaging substances and therefore does not belong in standard household waste. Their correct disposal will be performed by the respective collection facility.

DISPOSAL OF USED BATTERIES



Batteries contain environmentally damaging compounds and, therefore, do not belong in standard communal waste. Hand over used batteries for proper disposal at locations intended for their collection.

INSTRUCTIONS AND INFORMATION REGARDING THE DISPOSAL OF USED PACKAGING MATERIALS

Dispose of used packaging material at a site designated for waste in your municipality.

DISPOSAL OF USED ELECTRICAL AND ELECTRONIC EQUIPMENT



This symbol on products or original documents means that used electric or electronic products must not be added to ordinary municipal waste. For proper disposal, renewal and recycling, hand these products over to determined collection points. Alternatively, in some European Union states or other European countries you may return your products to the local retailer when buying an equivalent new product. Correct disposal of this product helps save valuable natural resources and prevents potential negative effects on the environment and human health, which could result from improper waste disposal. Ask your local authorities or collection facility for more details. In accordance with national regulations penalties may be imposed for the incorrect disposal of this type of waste.

For business entities in European Union states

If you want to dispose of electrical or electronic equipment, ask your retailer or supplier for the necessary information.

Disposal in other countries outside the European Union.

This symbol is valid in the European Union. If you wish to dispose of this product, request the necessary information about the correct disposal method from the local council or from your retailer.



This product meets all the basic requirements of EU directives related to it.

SENCOR hereby declares that radio device model number SRV 9385WH is in compliance with directive 2014/53/EU. The full wording of the EU Declaration of Conformity is available at the website: www.sencor.eu.

FAST ČR, a.s.
U Sanitasu 1621
CZ-251 01 Říčany
www.sencor.eu