

# SUMMIT

PROFESSIONAL

Upright refrigerator – freezer  
for built-in use

Model FFBF181SSBI

*Use & Care Guide*



**Felix Storch, Inc.**  
**Summit Appliance Division**  
**Bronx, New York 10474**  
**[www.summitappliance.com](http://www.summitappliance.com)**

Thank you for your confidence in buying our appliance and congratulations on the excellent choice. We expect it will successfully serve its purpose for many years.

**The appliance is intended solely for household use.**

**This upright refrigerator - freezer** (hereinafter: the appliance) is composed of two parts: the upper compartment is a refrigerator and the lower compartment is a freezer.

**The refrigerator** is used for the storage of fresh foods at temperatures above 32°F.

**The freezer** is used for freezing fresh foods and the storage of frozen foods for up to one year (depending on the type of food).

Write the Serial Number (found on the rating plate inside the appliance) here:

\_\_\_\_\_

<b>Important Safeguards.....</b>	<b>3</b>
<b>Before your first use .....</b>	<b>4</b>
<b>Description of the appliance .....</b>	<b>5</b>
<b>Installation and connection .....</b>	<b>6</b>
<b>Reverse door swing .....</b>	<b>8</b>
<b>Control panel - appliance with electronic regulation .....</b>	<b>9</b>
<b>Recommended distribution of food .....</b>	<b>12</b>
<b>Storing fresh food .....</b>	<b>13</b>
<b>Freezing and storage of frozen food .....</b>	<b>14</b>
<b>Defrosting the appliance.....</b>	<b>16</b>
<b>Cleaning .....</b>	<b>17</b>
<b>Troubleshooting guide.....</b>	<b>18</b>
<b>Noise level.....</b>	<b>19</b>
<b>Limited Warranty.....</b>	<b>20</b>



# IMPORTANT SAFEGUARDS

- **Before connecting the appliance, read these instructions carefully.**
- The appliance is manufactured in compliance with all relevant safety standards; however, it is recommended that persons with impaired physical, emotional, or mental abilities, or persons with inadequate experience and knowledge, do not use the appliance without due supervision. The same recommendation applies to minors using the appliance. Cleaning and user maintenance should not be performed by children without supervision.
- The appliance must be connected to the electrical supply in accordance with the standing regulations and local requirements.
- The appliance must not be used in open air or exposed to rain or other precipitation.
- Always disconnect the appliance from the power supply (pull the power cord from wall socket) before cleaning and before replacing the light bulb.
- If the power supply cord is damaged, in order to avoid a hazard it must be replaced only by qualified personnel.
- In the event of long periods without use, switch off the appliance with the ON/OFF button and disconnect it from the wall socket. Empty the appliance, clean the interior and leave the door ajar.
- For the protection of the environment, please contact local authorities for correct disposal arrangements.
- Never let children play with the appliance.
- **DANGER: Risk of child entrapment!** Before you throw away your old refrigerator or freezer: take off the doors and leave the shelves in place so that children may not easily climb inside.
- **Warning:** Ventilation slots on the appliance or built-in element should always be kept clean and unobstructed.
- **Warning:** Do not use any mechanical accessories when thawing the refrigerator, except for those explicitly recommended by the manufacturer.
- **Warning:** To prevent any pollution, be careful not to damage the insulation or refrigeration tubes at the rear wall during the installation, cleaning and disposal of the appliance.
- **Warning:** Do not use any electrical devices inside the appliance, except for those explicitly recommended by the manufacturer.



**This symbol on the product or on its packaging indicates that this product should not be treated as household waste. Instead it should be handed over to the applicable collection point for the recycling of electrical and electronic equipment. By ensuring this product is disposed of correctly, you will help prevent potential negative consequences for the environment and human health, which could otherwise be caused by inappropriate waste handling of this product. For more detailed information about recycling this product, please contact your local city office, your household waste disposal service or your place of purchase.**

– **Save these instructions** –

## Before your first use

- Before connecting the appliance, read these instructions carefully. They describe the appliance and provide instructions for its safe and correct use. The instructions are prepared for different types and models of the appliance so they may contain descriptions of functions and components your appliance may not have.  
Instructions also contain the NO FROST freezer version, with integrated fan and automatic defrost.
- Remove the wrapping protecting the appliance during transport.
- Door corners are fitted with protective spacers. Remove the spacers and replace them with the attached pegs (certain models only).
- Before connecting the appliance to the electrical supply, leave it in the upright position for about 2 hours. This will reduce the possibility of malfunctions in the cooling system resulting from prior transport and handling.
- The packaging of this appliance contains environmentally friendly materials which can be recycled, recovered or disposed of without threat to the environment.
- A self-closing door hinge (certain models only) pulls the door to the cabinet just before closing, thereby preventing the door from remaining ajar. Also, it limits the door's opening angle and prevents damage to adjacent surfaces.
- A rating plate with basic information is located in the interior of the appliance.

# Description of the appliance

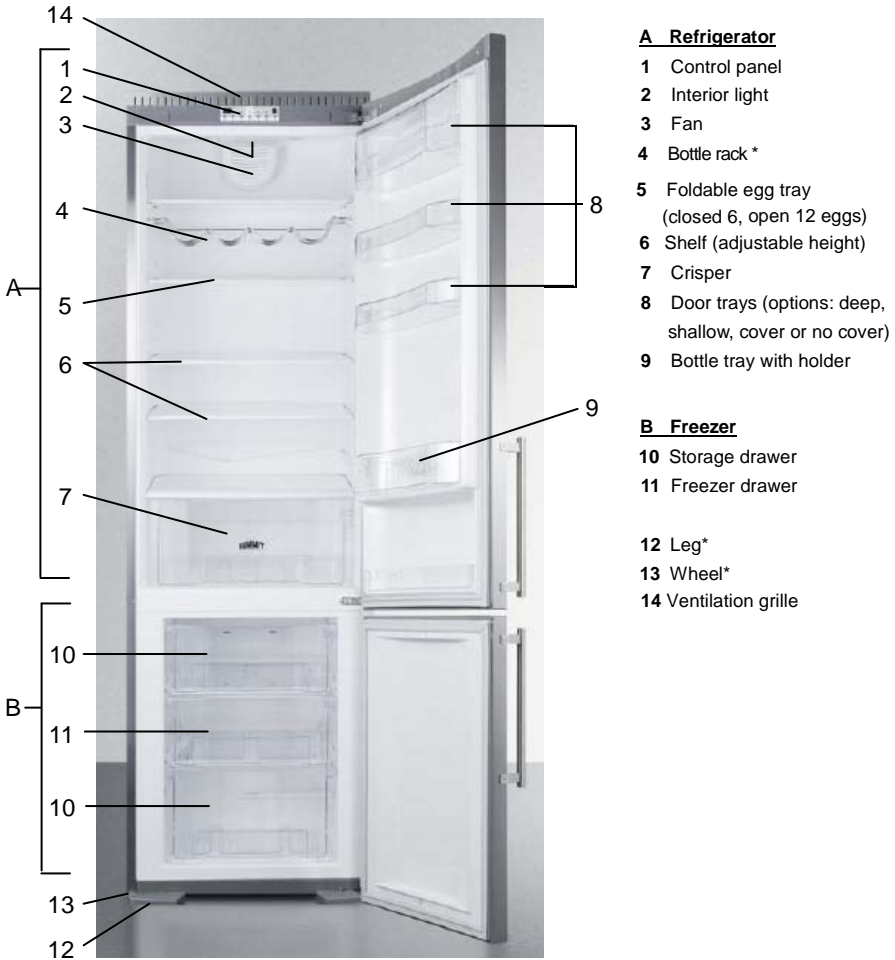

- Interior accessories may vary according to the model.
- Drawers are protected against accidental extraction. To remove the drawer from the appliance, open it and lift front part upwards, then pull it out. Certain models are fitted with pull-out slide guides which facilitate opening.
- Pull-out guide drawers (or shelves) are extracted by lifting the rear end and pulling out inclined at a 45° angle. Reinsert in opposite sequence.

\* Certain models only.

# Installation and connection

## Selecting the location

- Place the appliance in a dry and well-aired room. Ambient temperature should never be lower than 41°F.

## Positioning the appliance

*Positioning the appliance requires two persons in order to avoid injuries or damage to the appliance.*

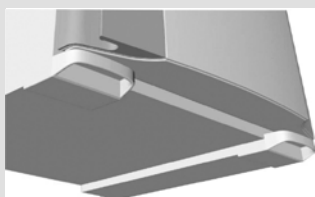

- This appliance is intended for built-in installation. Even so, when installing, please allow these minimum clearances to ensure the best operation and proper ventilation: 1/4" on both sides, 5/8" at the rear and 1/16" at the top. Be sure that airflow at the top of the appliance is not blocked. If the appliance is going to be placed against a wall, if possible leave extra space on the hinge side so the doors can open wider than their width (to make it easier to remove shelves and storage bins).
- Be sure the appliance rests flat on a solid base. The appliance is fitted with adjustable feet on the front side, used to level the appliance. The rear side of the appliance is fitted with wheels (certain models only) facilitating the positioning of the appliance at the preselected place.
- Avoid exposing the appliance to direct sunlight or heat sources. If this is not possible, install an insulation plate between the appliance and the adjacent heat source.
- The bottom front corners of the appliance are fitted with handles to facilitate moving (certain models only). The appliance may stand independently or adjacent to a wall, cabinet or other appliance. Be sure to leave enough space for the opening of the door, to avoid damage to the appliance or personal injury. Also leave ample space for removing shelves (see installation diagram on next page).

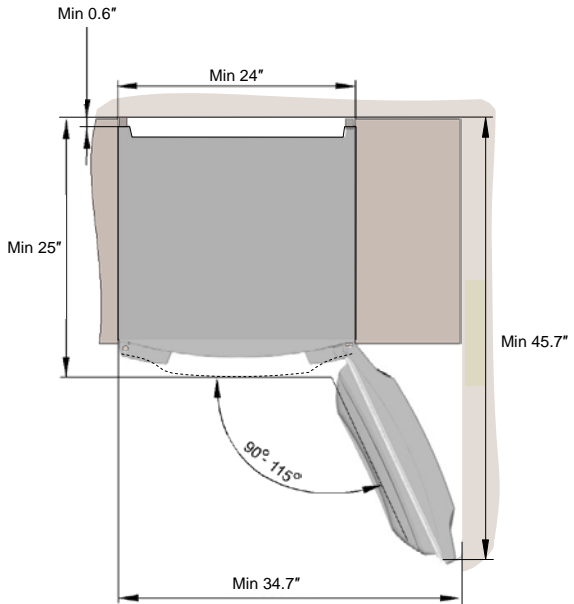

### ***Connecting to power supply***

- Use the power cord to connect the appliance to the electrical power. The wall outlet must be fitted with a ground terminal (safety socket).  
**The use of an extension cord is not recommended.** Nominal voltage and frequency are indicated on the relevant label or rating plate inside the appliance.
- The electrical power connection and grounding must be in accordance with standing regulations and local requirements.

The appliance is able to accommodate minor temporary voltage fluctuations that do not exceed  $\pm 6\%$ .

## Reverse door swing

**Required tools: socket wrench no. 8, screwdriver, torx 25.**

**Caution!** After unscrewing or before fixing hinges, hold the door to prevent it from falling and being damaged.

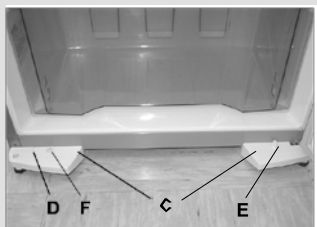
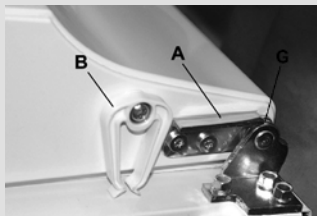

1. Remove upper hinge cover (save it for later use). Also remove the cover on the opposite side of the upper hinge cover (you will insert the attached cover on the other side during the assembly).
2. Unscrew upper hinge screws and remove the upper door from the middle hinge.
3. On the lower edge of the upper door unscrew the swing stopper screws and remove the stopper (A). Keep this for eventual use later on. Fix the attached stopper with its bearing on the opposite side of the door.
4. Unscrew the forced door closure system (B) and fix it to the opposite side of the door (certain models only).
5. Unscrew middle hinge screws, remove the door from bottom hinge.
6. Loosen the screws fixing the leg supports (certain models only), then continue with either procedure 7 or 7.1 below, depending on the model of the appliance.
7. Tilt the appliance backward (max. 35°) and let it rest against a firm support. Unscrew the leg support screws (C) - left and right, and remove the leg support cover (D) and place it on the opposite side. Unscrew and remove, then reverse the positions of end switch (E) and decorative peg (F).  
(For models with a forced door closing system, undo the three screws attaching the lower hinge and install the hinge on the opposite side.)
- 7.1. Tilt the appliance backwards (max. 35°) and let it rest against a firm support at the back.  
Undo the three screws attaching the lower hinge and install the hinge on the opposite side. Plug the holes left after this installation with the appropriate pegs.
8. Repeat procedures 3 and 4 on the bottom door. In case there is no bottom door limit peg, transfer the bearing (G) and washer to the opposite side of the door.
9. Proceed with the assembly procedure in opposite sequence.

# Control panel - appliance with electronic regulation

## CONTROL UNIT

### No-frost system appliance

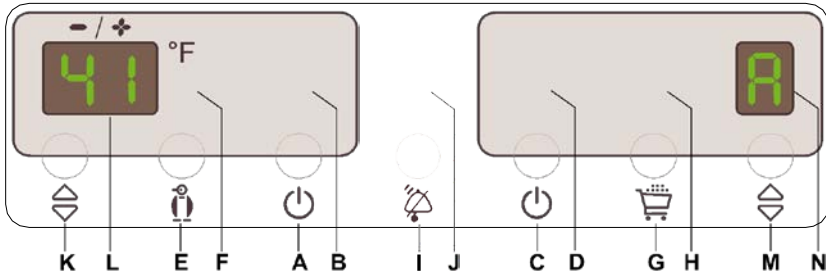

- A Freezer ON/OFF button**
- B Green signal lamp:** indicates freezer operation
- C Refrigerator ON/OFF button**
- D Green signal lamp:** indicates refrigerator operation
- E Intensive freezing ON/OFF button**
- F Orange signal lamp:** intensive freezing in operation
- G Intensive cooling ON/OFF button**
- H Orange signal lamp:** intensive cooling in operation
- I Sound alarm and child lock ON/OFF button**
- J Red signal lamp:** alarm is active
- K Temperature setting buttons**
- L Digital display indicating current temperature in the refrigerator or the set refrigerator or freezer temperature:** refrigerator temperature from 34°F to 48°F, freezer temperature from 7°F to -9°F
- M Temperature setting button:** for refrigerator or freezer temperature
- N Digital display indicating the selection of temperature setting for either refrigerator or freezer:** F – for freezer, R – for refrigerator

## Switching the appliance ON/OFF

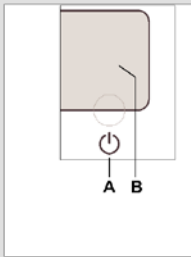

Before the first use of the appliance first plug the power cable into the wall socket. Display indicates dashes for both the refrigerator and the freezer.

- Switch the appliance ON by pressing the button **A** for 3 seconds. Both the refrigerator and the freezer are started, green signal lamps **B** and **D** are on. In this mode you can switch off the refrigerator only by pressing button **C** for 3 seconds (green signal lamp **D** is off).
- Refrigerator temperature of +48°F is indicated on the display. This value will remain on the display until the temperature in the refrigerator drops below this level.

The appliance has been preset in the factory to the recommended temperatures of the refrigerator (+41°F) and freezer (0°F).

## Temperature setting



**Temperature setting range of the refrigerator: +34°F do +48°F.**

**Temperature setting range of the freezer: 7°F to -9°F.**

- To set the freezer temperature, first select the freezer by pressing the **M** button (letter "F" will be indicated on the display **N**); then, use the **K** button to set the desired temperature. To set the refrigerator temperature, first select the refrigerator by pressing the **M** button (letter "R" will be indicated on the display **N**); then, use the **K** buttons to set the desired temperature.
- After pressing the temperature setting buttons the display starts flashing and indicates the last selected setting.
- Temperature setting is changed by short consecutive pressing of the button in 1°F steps. During the setting procedure all other buttons are idle.
- Approximately 5 seconds after the setting button is released the display indicates the actual temperature.

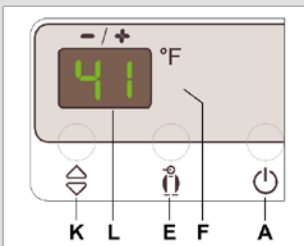

## Other settings

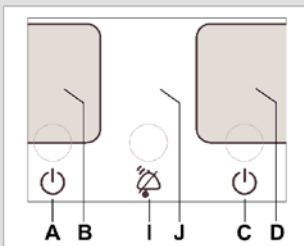

## Alarm

### Continuous sound - open refrigerator door alarm

If the refrigerator door is open for more than one minute, the sound alarm is turned on (**continuous tone**) and red signal lamp **J** is on. The alarm is automatically switched off when the door is closed, but you can also switch it off by pressing the Alarm Off button (**I**).

### Intermittent sound - freezer/refrigerator temperature is too high

Sound alarm is also activated in case of elevated temperature (intermittent tone), and the temperature on the display is flashing.

- Sound alarm is switched off by pressing button **I**. Red signal lamp and temperature flashing are stopped automatically when the freezer/refrigerator has cooled enough that there is no more risk of food becoming unsafe to eat.
- If the freezer temperature fails to arrive at the adequate level 24 hours after the alarm was switched off it is activated again, and again switched off automatically when the freezer has cooled enough for safe storage of food. During the initial start of the appliance there is a 24 hour delay of the temperature alarm to avoid unnecessary alarm operation.

### Intermittent alarm sound - power failure signal

If the temperature of the refrigerator or freezer is raised too much as a consequence of power failure, the sound alarm is activated (intermittent tone), the red signal lamp is on, and the display flashes the highest temperature digit (in the case of the refrigerator, a maximum of 48°F).

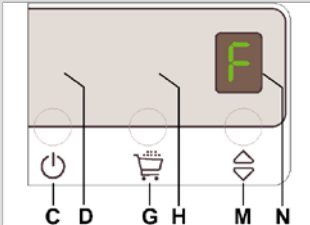

### Intensive cooling

Intensive cooling of the refrigerator is activated by pressing the button **G** (orange signal lamp **H** is on). It is automatically switched off after 6 hours, and the selection is set back to the previous value. **It is intended for fast cooling of a large quantity of food.**

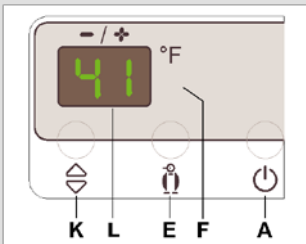

### Intensive freezing

This is activated by pressing the button **E** (orange signal lamp **F** is on), and the intensive cooling of the freezer starts. If the setting is not deactivated (by pressing the **E** button once again), the setting will be deactivated automatically approximately two days after activation. Setting is intended **for fast freezing of large quantities** of inserted food. In case of power failure the fast freezing process is repeated. Use the setting also with the first start of the appliance, before intended cleaning, and in the case of large quantities of food inserted into the appliance.

### Child lock

Integrated child lock protects the appliance from accidental temperature setting changes or even switching the appliance off. You can activate or deactivate the child lock by pressing the alarm button (**I**) for 3 seconds (both displays flash 'LL' and 'L' for 3 seconds). Once the child lock is activated, only the alarm button is active. Pressing any other button provokes the letters 'LL' and 'L' to appear on the display.

# Recommended distribution of food

## ***Recommended distribution of food***

### **Refrigerator compartments:**

- **top section:** canned food, bread, wine, cake, ...
- **middle section:** dairy products, cheese, ready-made food, desserts, juices, beer, ...
- **bottom section:** meat, meat products, delicatessen, ...
- **crisper:** fresh fruit, vegetables, salads, root vegetables, potatoes, onions, garlic, tomatoes, sauerkraut, turnips, ...

### **Refrigerator door lining compartments:**

- **top/middle section:** eggs, butter, cheese, ...
- **bottom section:** beverages, cans, bottles, ...

### **Freezer sections:**

- **door compartments:** packed vegetables, ice cream, ice,...
- **other compartments:** freezing, storing frozen food or quick cooling of bottles (see section "Freezing and storing frozen food", setting "Quick cooling of drinks in the freezer", ...)

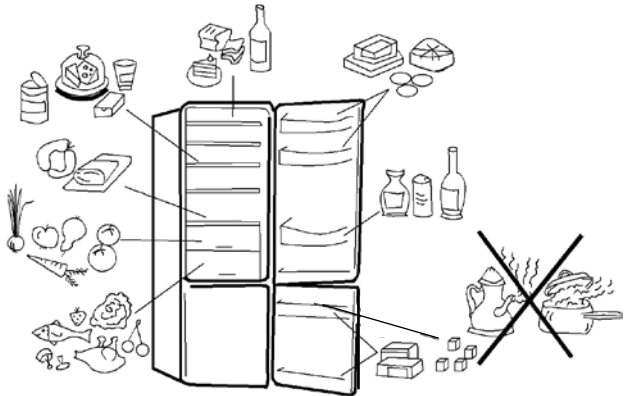

# Storing fresh food

## Important precautions for storing fresh food

- ⚠ Proper use of the appliance, adequately packed food, correct temperature and hygienic precautions have substantial impact on the quality of stored food.
- ⚠ Always respect the use-by date, printed on the packaging.
- ⚠ Food to be stored in the refrigerator should be properly packed so as to prevent absorbing of moisture and building up of odors.
- ⚠ Never store inflammable, volatile or explosive substances.
- ⚠ Beverages with high alcohol percentage must be stored in tightly sealed bottles in upright position.
- ⚠ Some organic solutions (e.g.: strong oils in lemon/orange peel and acids in butter, etc.) can cause damage through prolonged contact with plastic surfaces or gaskets; they can cause accelerated ageing of the plastic material.
- ⚠ An unpleasant odor inside the refrigerator is a sign that something is wrong with food or that your refrigerator needs cleaning (see chapter on Cleaning).
- ⚠ If you are away for a lengthy time, please remove all perishables beforehand.

## Interior accessories and space distribution



### Equipment depends on the model.

- Shelves can be optionally placed on the guides inside the appliance. They are protected from being accidentally pulled out completely. To remove the shelf, raise the back part, level off and pull it out. Easily perishable food should be stored at the back, i.e. the coldest part of the shelves.
- Certain models are equipped with a wire bottle rack which enables storing bottles horizontally. It is safe-guarded against pulling out. It may be pulled out only if empty, by lifting the front part and pulling it towards you. Place the bottle rack in the appliance in such way as to avoid obstruction of door closing by the length of the stored bottles.  
Maximum load of the rack is 9 bottles of 750 ml, or 29 lbs of total mass - see label at the right side of the interior of the appliance.
- The crisper below the glass shelf at the bottom of the refrigerator is used for storage of fruits and vegetables. It retains the right level of moisture and prevents drying out.
- The inner refrigerator door consists of various shelves or holders used for storing cheese, butter, eggs, yogurt, and a

stock of other smaller packages, tubes, cans, etc. The bottom shelf is used for storing bottles.

- The freezer door liner is also fitted with various shelves or holders used for storing frequently used frozen food for quick access (ice cream, already opened packages of vegetables, etc.).
- Fan (certain models only - located under the ceiling or hidden behind rear panel of the refrigerator, or concealed within the freezing unit) improves even distribution of temperature and reduces condensation on storage racks.

### Storage time of fresh foods

### Approximate storage time of fresh foods

Food	Period
eggs, marinades, smoked meat	up to 10 days
cheese	up to 10 days
carrots, etc.	up to 8 days
butter	up to 7 days
cake, fruit, left-overs, raw chunks of meat	up to 2 days
fish, raw ground meat, seafood	up to 1 day

## Freezing and storage of frozen food

### Freezing procedure

- 24 hours before freezing fresh food, activate the rapid freezing function (freeze boost) - press the **E** key.







After this period place fresh food in **the freezing compartment**. In the NO FROST freezer model, use the central drawer for freezing.

Do not let the already frozen packages touch the fresh ones. NO FROST freezers require enough space under the ceiling for the circulation of cold air, so avoid storing the food above the marked level (see photo).

- After 24 hours you may move the food to **the storage compartment**, and repeat the freezing procedure if required. You may also remove the drawers and store frozen food directly on cooling shelves. Do not remove the lower drawer if you have a NO FROST appliance!
- For freezing smaller quantities of fresh food (2 - 4½ lbs), the engagement of the fast freeze function is not required.



### **Important precautions for freezing of fresh food**

-  Freeze only such foods that are suitable for freezing and can sustain low temperatures. Food should be of adequate quality and freshness.
-  Select adequate packaging for each kind of food and pack it correctly.
-  The packaging should be airtight and well sealed without leaking since this could cause substantial vitamin loss and dehydration.
-  Mark packages with the following data: Type, kind and amount, date.
-  It is important that food be frozen as quickly as possible. We therefore recommend the size of the package not be too large; it should be cooled before placing into the freezer.
-  The amount of fresh food that can be put into the freezer as a single load is stated on the rating plate. If the loaded amount is too large, the quality of freezing is reduced which in turn affects the quality of frozen foods.

### **Storing commercially frozen food**

The storage time and recommended temperature for storing commercially frozen foods is indicated on the package. Always follow manufacturer's instructions for storage and use of frozen food. When shopping be careful to choose only food that is adequately packed and provided with complete data and stored in freezers where the temperature never rises above 0°F. Do not buy packages of food covered with frost. This indicates that the package was thawed before at least once. Take care that packages don't start to thaw during transport to your home. Temperature rise shortens the storage time and affects the quality of commercially frozen foods.

### **Approximate storage time of frozen foods**

<b>Food</b>	<b>Storage Period</b>
Fruit, beef	from 10 to 12 months
Vegetables, veal, poultry	from 8 to 10 months
Venison	from 6 to 8 months
Pork	from 4 to 6 months
Chopped (ground) meat	4 months
Bread, pastry, TV dinners, fat-free fish	3 months
Sweetbreads	2 months
Smoked sausages, fatty fish	1 month

## ***Defrosting frozen food***

Partially thawed or defrosted foods should be used as soon as possible. Cold air preserves the food but it does not destroy microorganisms that rapidly activate after defrosting and make foods perishable.

Partial defrosting reduces the nutritional value of food, especially fruits, vegetables and ready-made meals.

## ***Making ice***



Remove the cap from ice tray (certain models only) and fill it to the mark with filtered cold water. Close it and place it on the door shelf. Ice tray can freeze 8 cubes.

Ice cubes are discharged from the tray by turning the tray upside down and placing it under cold running water. Shake the tray, open the cover and pour the ice out.

## **Defrosting the appliance**

### ***Automatic defrosting of the refrigerator***

The appliance needs no special defrosting procedure, because ice deposited at the inner back wall is defrosted automatically. Ice deposited on the inner back wall during compressor operation is defrosted when the compressor stops operating, and condensed water drops are drained through the outlet in the inner back wall into the drain pan situated above the compressor where it evaporates. In case of excessive ice deposits at the inner rear wall of the refrigerator (thickness of 1/4"), switch the appliance off by pressing the ON/OFF button and defrost it manually.

### ***Defrosting of NO FROST freezer***

- Defrosting of NO FROST freezer is automatic. Periodic appearance of frost layer eventually disappears automatically.
- Build-up of ice or frost in the freezer compartment can be a result of abnormal use of appliance (door opened too frequently and/or too long, door not properly closed, etc.). In this case, unplug the appliance, remove the food from the freezer and protect it from defrosting. Clean and dry the freezer interior. Before returning the frozen food into the freezer, switch on the appliance and select the desired setting.

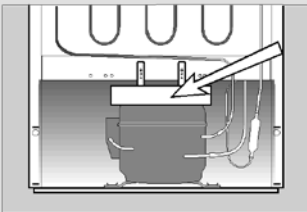
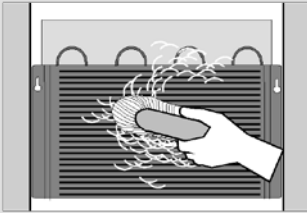

**Prior to any cleaning, disconnect the appliance** (turn the thermostat button to the position  and pull the power cord from the electrical outlet). Special antibacterial protection in the top layer of the inner walls prevents growth of bacteria and keeps the interior clean and germ free. Make sure to remove traces of any cleaning agents you may have been using.

- To clean any surface, use a soft cloth.
- Clean **the exterior** of the appliance with water and mild liquid detergent.
- For cleaning of plastic, coated, or aluminum parts avoid using abrasive or special cleansing agents (like stainless steel polish), otherwise you may damage the surface.
- Clean coated and aluminum surfaces using the soft cloth and an alcohol-based cleaning agent (like glass cleaner).
- Wash **the interior** of the appliance with mild liquid detergent and lukewarm water, mixed with a little vinegar.
- The groove and drain outlet located below the cooling panel at the rear wall collect the drained water, so should not be clogged (e.g. with food particles). Make sure you inspect them periodically and clean if necessary (use a plastic straw to free the outlet hole).
- **The condenser** on the rear wall must always be kept clean and free of dust or kitchen fume deposits. Therefore clean off the dust periodically with a non-metallic brush or vacuum cleaner.
- Also clean **the drip pan** above the compressor. If you removed the pan, please make sure you replace it in the same position, and check that it is completely horizontal!
- After cleaning, switch the appliance on and reload the food.

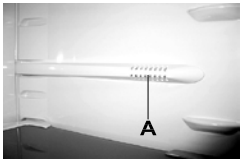

# Troubleshooting guide

Problem	Cause/Remedy
The appliance does not operate after connection to the power line:	<ul style="list-style-type: none"> <li>• Check if there is power in the socket and if the appliance is switched on.</li> </ul>
Cooling system operates continuously without intermittent stoppages:  	<ul style="list-style-type: none"> <li>• Ambient temperature too high.</li> <li>• Frequent opening of the door, door open too long.</li> <li>• Door not closed properly (something caught in door gasket, sagging door, check gasket sealing, etc.).</li> <li>• Excessive quantity of fresh food inserted at one time.</li> <li>• Refrigerator sensor (A) is blocked with fresh food. Free the sensor and allow air to circulate around it (certain models only).</li> <li>• Check air circulation for sufficient cooling of the compressor, and clean the condenser.</li> </ul>
Excessive ice formation at the rear interior wall of the refrigerator:	<ul style="list-style-type: none"> <li>• Frequent opening of the door, door open too long.</li> <li>• Inserting hot food in the refrigerator.</li> <li>• Food or dish is touching the rear interior panel of the refrigerator.</li> <li>• Bad door sealing; clean or replace the gasket if dirty or damaged.</li> </ul>
Build-up of ice or frost in the freezer interior may be a result of the following:	<ul style="list-style-type: none"> <li>• Door opened too frequently or too long.</li> <li>• Door not properly closed.</li> <li>• Poor door sealing.</li> <li>• If the seal is dirty or damaged, clean or replace it.</li> </ul>
Water dripping from the appliance:	<ul style="list-style-type: none"> <li>• Drain outlet is clogged, drain water drips past the collection groove.</li> <li>• Clean the clogged outlet using plastic straw.</li> <li>• Thaw thick ice deposits manually (see chapter <i>Defrosting</i>).</li> </ul>
Red light is flashing (freezer compartment only):	<ul style="list-style-type: none"> <li>• Frequent opening of the door, door open too long.</li> <li>• Door not closed properly (something caught in door gasket, sagging door, damaged gasket, etc.).</li> <li>• Excessively long power failure.</li> <li>• Excessive quantity of fresh food inserted at one time.</li> </ul>
Difficult door opening:	<ul style="list-style-type: none"> <li>• If you attempt to open the door of the freezer immediately after it has been closed you may experience resistance. This happens because a certain quantity of cold air escapes from the appliance through the open door and is replaced by warm ambient air. Cooling of such air creates negative pressure (vacuum) and suction, which prevents easy opening of the door. This is normalized after several minutes and you can open the door with ease.</li> </ul>

Problem	Cause/Remedy
Bulb replacement: 	<ul style="list-style-type: none"> <li>• Before replacing the light bulb, disconnect the appliance from the power supply. Using a screwdriver, remove the cover, replace the bulb with a new one (E 14, max. same voltage as the factory bulb) and fit back the cover.</li> <li>• Don't forget: the old bulb is not organic waste.</li> <li>• The light bulb is a consumable item and is not covered by the warranty.</li> </ul>
Green LED is flashing:	<ul style="list-style-type: none"> <li>• If the green LED is flashing, call the nearest service center.</li> </ul>
Troubleshooting helpful hints:	<ul style="list-style-type: none"> <li>• If you are not able to fix the trouble by any of the above tips, turn the thermostat button to the position  and disconnect the power cord from the power outlet. Wait 10 minutes, and reconnect the appliance. Should none of the above guidelines be helpful, please call for service assistance, quoting information given on the rating plate either within or at rear of your appliance.</li> </ul>

## Noise level

Cooling of refrigerator-freezer appliances is provided by a compressor cooling system (for certain appliances, also the fan). Operation of this system results in a certain amount of noise, the intensity of which depends upon the installation, correct use, and age of the appliance.

- **After starting** the appliance, the operation of the compressor (the refrigerant flow) may be somewhat louder. This does not mean that something is wrong with the appliance, nor does it have any influence on the lifetime of the appliance. Gradually the noise is reduced and eventually subsides.
- Sometimes the appliance produces **unusual and stronger noises**. These noises are often the consequence of inadequate positioning of the appliance:
  - The appliance should be placed on a flat and firm base.
  - It should not touch the wall or kitchen units standing next to it.
  - Check whether the accessories in the interior of the appliance are placed correctly in their positions; also check the bottles, cans and other vessels that might touch each other and rattle.

THE MANUFACTURER RESERVES THE RIGHT TO ALTER THE SPECIFICATIONS WITH NO IMPACT TO THE FUNCTIONAL OPERATION OF THE APPLIANCE.

# Limited Warranty

## ONE-YEAR LIMITED WARRANTY

Within the 48 contiguous United States, for one year from the date of purchase, when this appliance is operated and maintained according to instructions attached to or furnished with the product, warrantor will pay for factory-specified parts and repair labor to correct defects in materials or workmanship. Service must be provided by a designated service company. Outside the 48 states, all parts are warranted for one year from manufacturing defects. Plastic parts, shelves and cabinets are warranted to be manufactured to commercially acceptable standards, and are not covered from damage during handling or breakage.

## 5-YEAR COMPRESSOR WARRANTY

1. The compressor is covered for 5 years.
2. Replacement does not include labor.

### *ITEMS WARRANTOR WILL NOT PAY FOR:*

1. Service calls to correct the installation of your appliance, to instruct you how to use your appliance, to replace or repair fuses or to correct wiring or plumbing.
2. Service calls to repair or replace appliance light bulbs or broken shelves. Consumable parts (such as filters) are excluded from warranty coverage.
3. Damage resulting from accident, alteration, misuse, abuse, fire, flood, acts of God, improper installation, installation not in accordance with electrical or plumbing codes, or use of products not approved by warrantor.
4. Replacement parts or repair labor costs for units operated outside the United States.
5. Repairs to parts or systems resulting from unauthorized modifications made to the appliance.
6. Expenses for travel and transportation for product service in remote locations.
7. The removal and reinstallation of your appliance if it is installed in an inaccessible location or is not installed in accordance with published installation instructions.

## DISCLAIMER OF IMPLIED WARRANTIES; LIMITATION OF REMEDIES

CUSTOMER'S SOLE AND EXCLUSIVE REMEDY UNDER THIS LIMITED WARRANTY SHALL BE PRODUCT REPAIR AS PROVIDED HEREIN. IMPLIED WARRANTIES, INCLUDING WARRANTIES OF MERCHANTABILITY OR FITNESS FOR A PARTICULAR PURPOSE, ARE LIMITED TO ONE YEAR. WARRANTOR SHALL NOT BE LIABLE FOR INCIDENTAL OR CONSEQUENTIAL DAMAGES. SOME STATES DO NOT ALLOW THE EXCLUSION OR LIMITATION OF INCIDENTAL OR CONSEQUENTIAL DAMAGES, OR LIMITATIONS ON THE DURATION OF IMPLIED WARRANTIES OF MERCHANTABILITY OR FITNESS, SO THESE EXCLUSIONS OR LIMITATIONS MAY NOT APPLY TO YOU. THIS WARRANTY GIVES YOU SPECIFIC LEGAL RIGHTS AND YOU MAY ALSO HAVE OTHER RIGHTS, WHICH VARY FROM STATE TO STATE.

**WARNING!** This product may contain chemicals known to the state of California to cause cancer or birth defects or other reproductive harm. For more information, visit: [www.summitappliance.com/prop65](http://www.summitappliance.com/prop65)

Chemicals known by the manufacturer to be present in this product in concentrations higher than threshold limits: NONE.

**FELIX STORCH, INC.**  
770 Garrison Avenue  
Bronx, NY 10474  
Phone: (718) 893-3900  
Fax: (844) 478-8799  
[www.summitappliance.com](http://www.summitappliance.com)

**SUMMIT**  
PROFESSIONAL

For parts and accessory ordering,  
troubleshooting and helpful hints, visit:  
[www.summitapplianceparts.com](http://www.summitapplianceparts.com)