

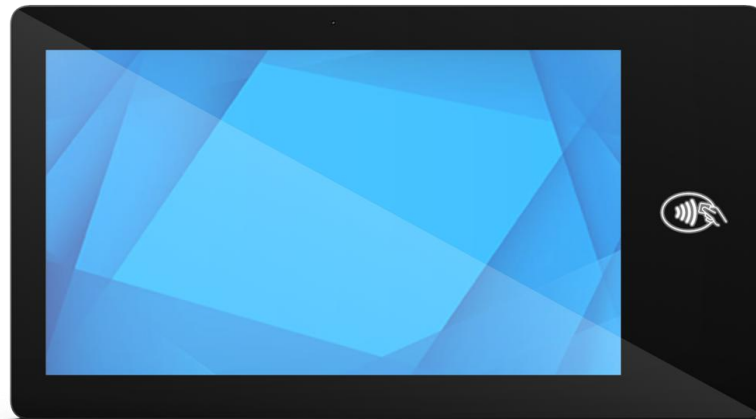

USER MANUAL

Elo Touch Solutions
Elo Pay 15" "Tap-to-Pay"
ESY1511E



Copyright © 2025 Elo Touch Solutions, Inc. All Rights Reserved.

No part of this publication may be reproduced, transmitted, transcribed, stored in a retrieval system, or translated into any language or computer language, in any form or by any means, including, but not limited to, electronic, magnetic, optical, chemical, manual, or otherwise without prior written permission of Elo Touch Solutions, Inc.

Google Play services

Disclaimer

The information in this document is subject to change without notice. Elo Touch Solutions, Inc., and its Affiliates (collectively "Elo") makes no representations or warranties with respect to the contents herein and specifically disclaims any implied warranties of merchantability or fitness for a particular purpose. Elo reserves the right to revise this publication and to make changes from time to time in the content hereof without obligation of Elo to notify any person of such revisions or changes.

Trademark Acknowledgments

Elo, Elo (logo), Elo Touch, Elo Touch Solutions, EloView, are trademarks of Elo and its Affiliates.



Contents

Section 1.....	6
Product Description.....	7
Overview – Specifications	7
Features: Elo Pay 15" "Tap-to-Pay"	8
Section 2.....	9
Unpacking	10
How to Install Power over Ethernet (Elo Part Number E669163)	11
Power Button.....	11
Power LED Status	11
Power / Function Buttons Features and Gestures	12
Out of Box Experience (OOBE)	13
Elo Home APK Home Screen – Enroll with Eloview	14
Screen Lock and Home Screens – GMS	16
Section 3.....	21
Network & Internet	22
Wi-Fi hotspot	24
Connected devices.....	26
PoE Power Manager	30
NFC	32
Apps & Notifications.....	33
Display.....	36
Screen timeout	37
Auto-rotation screen	37
Font size	38
Display size	38
Sound	41



Storage	46
Storage Manager	46
Wakeup Source	47
Location.....	49
Security & Privacy.....	50
Security	50
App Security	50
Device Unlock	50
Account security	51
Device Finders	51
System & updates	52
Privacy	52
Permission Manger	52
Privacy dashboard	53
Ads	53
Data sharing updates for location	53
More security & privacy	53
Accounts	54
Accessibility	55
Digital Wellbeing & parental controls	57
System	58
Reset options	61
Multiple users	61
To switch users	61
To add user	61
To delete guest from the device	61
To rename Admin Profile info	62
Developer	62
About tablet	63



Section 4	64
About Camera App (Snapdragon).....	65
Take a Picture and Record Video.....	67
Take a Screenshot	68
File Application	68
General-purpose Input/Output (GPIO) Support	70
About Debug Bridge (ADB) control	71
Optional Flip Stand (Elo Z20 Stand)	72
Factory Full Reset	73
Optional Peripherals.....	74
 Section 5: Technical Support and Maintenance	 76
Technical Assistance	76
Elo Pay 15" "Tap-to-Pay" Care and Handling	77
Operating time and Panel Image Sticking	78
 Section 6: Regulatory Information	 79
Electrical Safety Information	79
Emissions and Immunity Information	79
Radio Equipment Directive	82
Agency Certifications	83
Waste Electrical & Electronic Equipment Directive (WEEE)	84
Energy Star.....	84
Child Safety Warning	85
 This Product is not intent for use by children. This product is not suitable for use in locations where children are likely to be present	 85
 Section 7: Warranty Information	 86



Section 1

Introduction



Product Description

Your new Elo Pay 15" "Tap-to-Pay" Interactive Signage system combines reliable performance from Elo with the latest developments in touchscreen technology and display design. This combination of features creates a natural flow of information between a user and the Elo Pay 15" "Tap-to-Pay" system.

Overview – Specifications

Feature	Specification
Operating System	Powered by Android™
Processor	Qualcomm QCS6490
Memory	8GB
Internal Storage	64GB
Display	1920 x 1080
Aspect Ratio	16:9
Touch Screen	Capacitive touch; up to 10 touches
Camera	8MP - 3200*2400, Auto Focus
Micro-SD	Support for microSD cards (up to 2TB)
Wi-Fi + Bluetooth	IEEE 802.11a/b/g/n/ac/ax + Bluetooth 5.2 with BLE
Microphone	2x Digital Microphones
Speaker	2x 1.5W
USB Port and Video Port	4x microUSB ⁽¹⁾ ports (500mA) 1x USB 3.0 Type A (900mA) 1x Type-C (Power Delivery ⁽²⁾ and Video out ⁽³⁾) <small>(1) Support for 1.2A on one port and 500mA for the remaining three ports (2) Support for 5V/3A, 9V/3A, 15V/1.8A, 20V/1.35A, max 27W (3) Support up to 4k30 DP Alt. Mode (with USB 2.0 high speed when DP alt).</small>
Temperature	Operating: 0°C to 40°C (32°F to 104°F) Storage: -20°C to 50°C (-4°F to 122°F)
Humidity	Operating: 20% to 80% Storage: 10% to 90%



Features: Elo Pay 15" "Tap-to-Pay"

- 15.6-inch Display
- 8 Megapixel Camera
- Dual Microphones
- Dual Speakers
- 2 MIMO Wi-Fi Antennas
- Vesa Mounting pattern 75 and 100mm

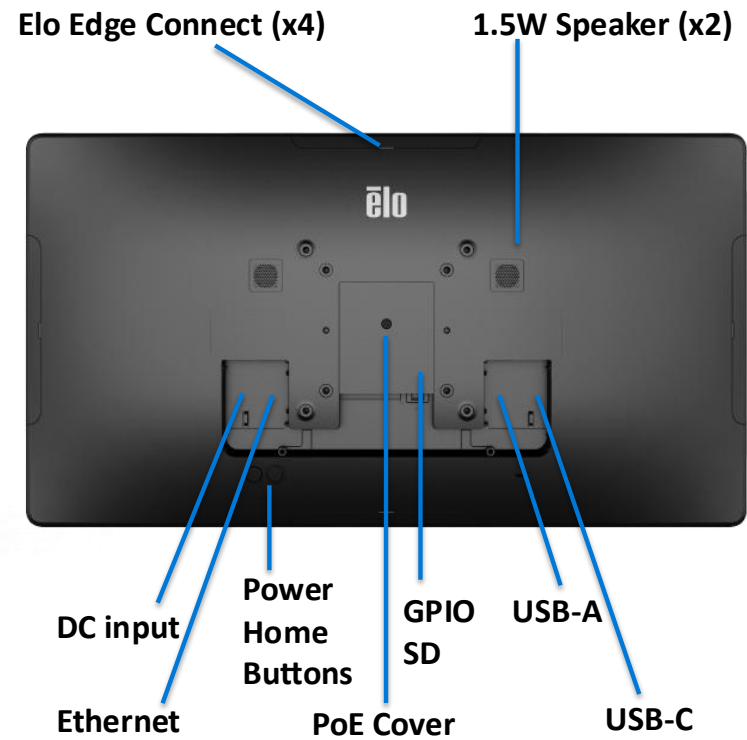
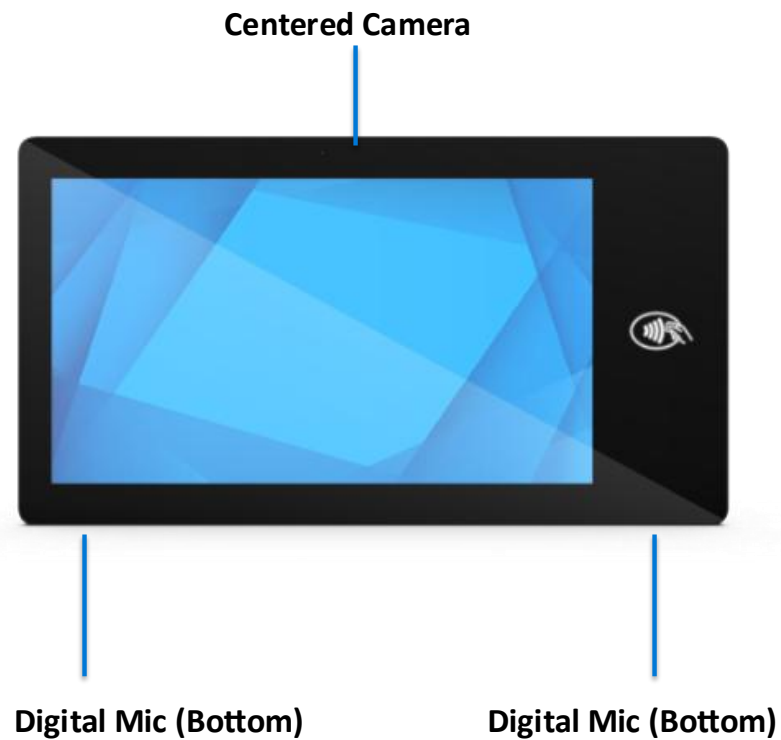

Section 2

Getting Started



Unpacking

Verify that the box contains:

- Elo Pay 15" "Tap-to-Pay"
- Power Brick
- North American Power Cable
- European Power Cable
- Quick Install Guide
- Screws for cable cover door

Remove all protective materials from the device.

Inspect the device for damage.

Report immediately if the system has damaged part and/or missing items as listed above.

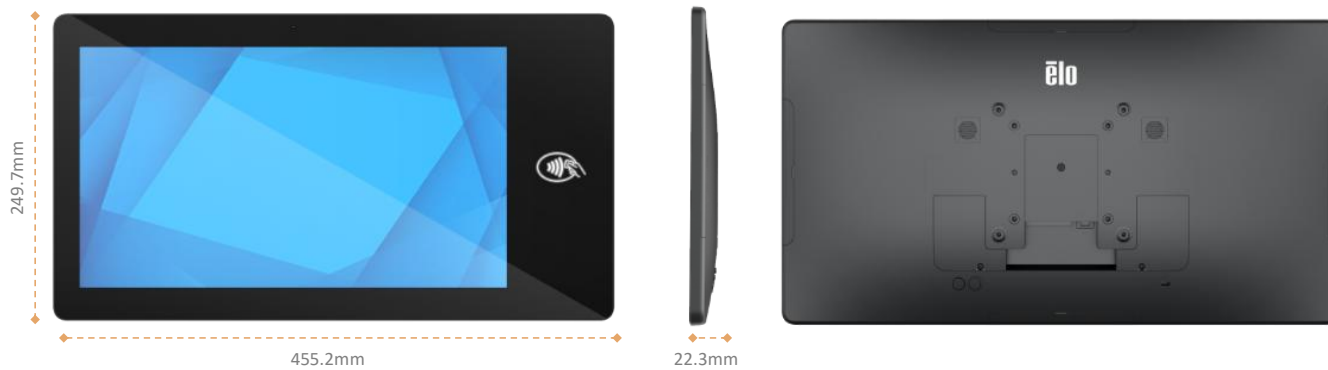

How to Install Power over Ethernet (Elo Part Number E669163)

- Unscrew the PoE cover from the back of the device.
 - See full details in the Power over Ethernet kit Quick Install Guide
- Mount the PoE module so that the pins line up with the mating receptacle.
 - This equipment is only to be connected to PoE networks without routing to outside plants

Power Button

Note: As soon as power is applied to the system, the device will boot up.

Do not touch the screen during the system boot up.

- To turn ON the system, press power button for 500 milliseconds.
- To Shut down or Restart, press and hold the power button for more than 2 seconds and follow the on-screen display menu.
- To force the system to Shut down, press and hold the power button for 12 seconds.
- To bring the system out of sleep/standby mode, either press the power button once or touch the screen.

Power LED Status

POWER LED STATUS	DESCRIPTION
OFF	OFF
Solid White	Power ON
Solid Orange	Power OFF
Blinking White	Idle Mode



Power / Function Buttons Features and Gestures

Power button On-Screen display menu

If the power button is pressed for more than 2 seconds, a pop-up screen menu will appear.

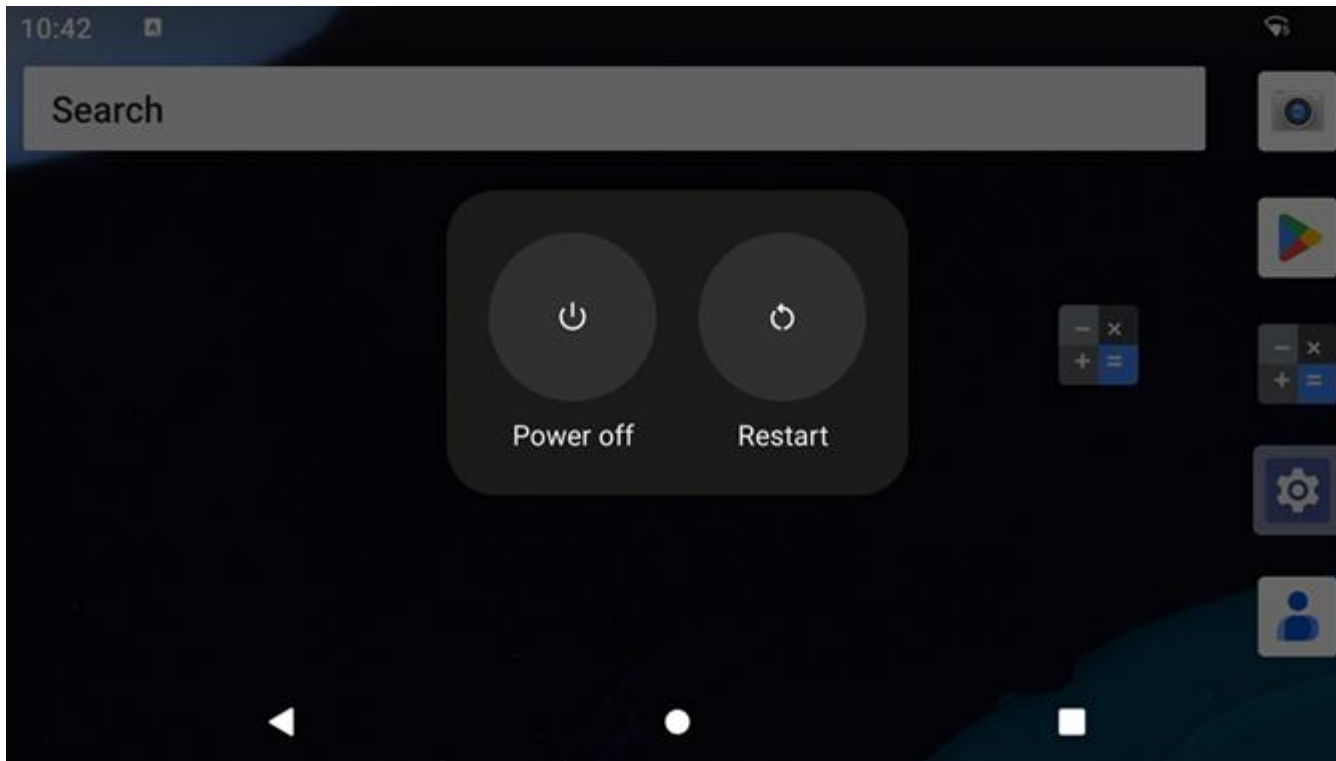

Out of Box Experience (OOBE)

Step 1:

- Choose the following set up method.

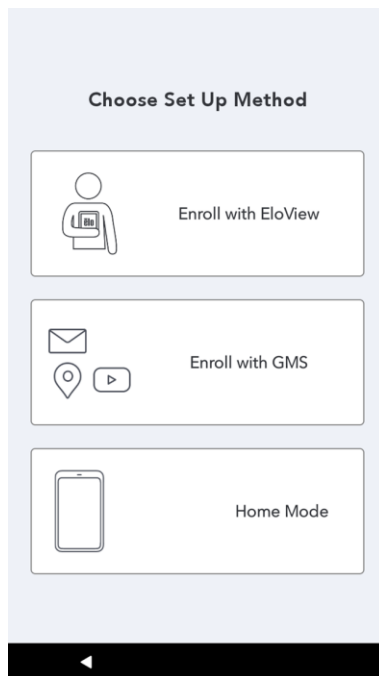

Step 2:

- Follow on-screen instructions to complete the setup.
- To enroll with EloView® you must connect to Wi-Fi.

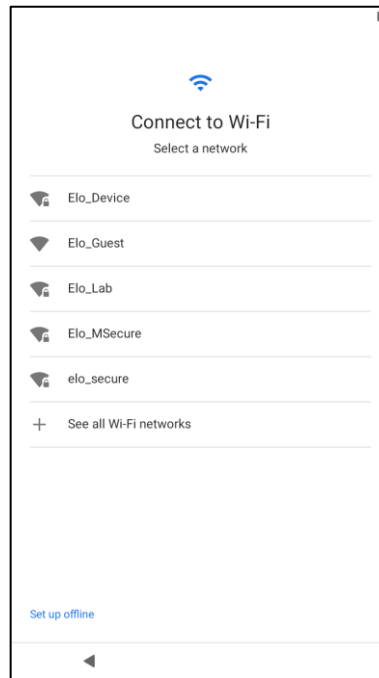

Step 3:

- Go to Page15-16 for EloView® Home (screen locked at default).
- Go to Page17-21 for GMS and Android Home.

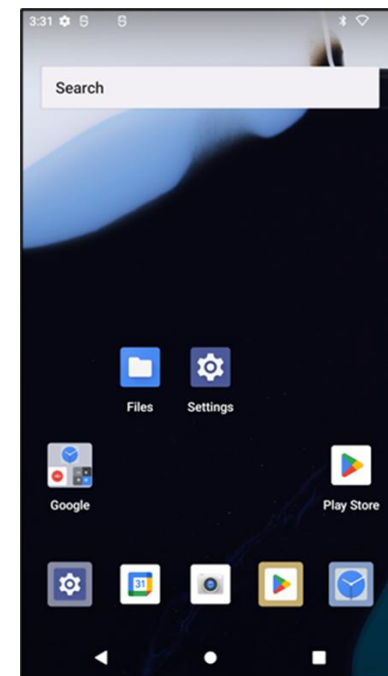

Elo Home APK Home Screen – Enroll with Eloview

Refer to ELOVIEW SUPPORT PAGE on www.elotouch.com for Eloview information

The Elo Home APK Home Screen is the starting point for navigating of the device. You can place your favorite apps and widgets here.

Note: The images below may appear different from the actual device.

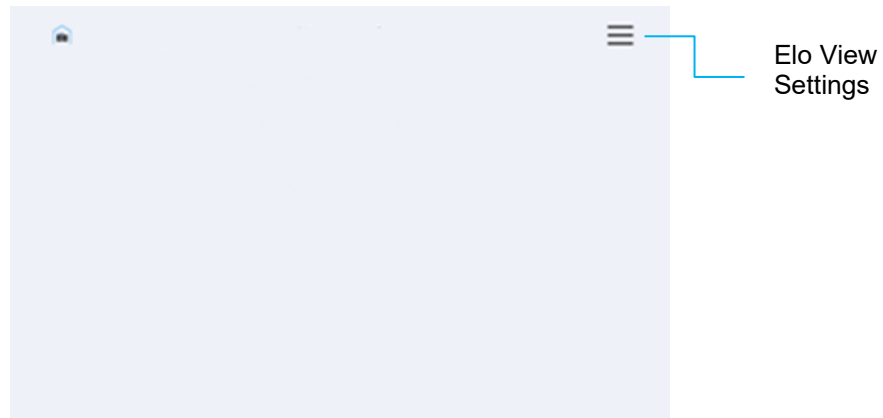

Elo Home APK Quick Settings

To access the Quick Settings, tap  3 lines menu from Elo Home APK Home Screen. Located on the upper right side.

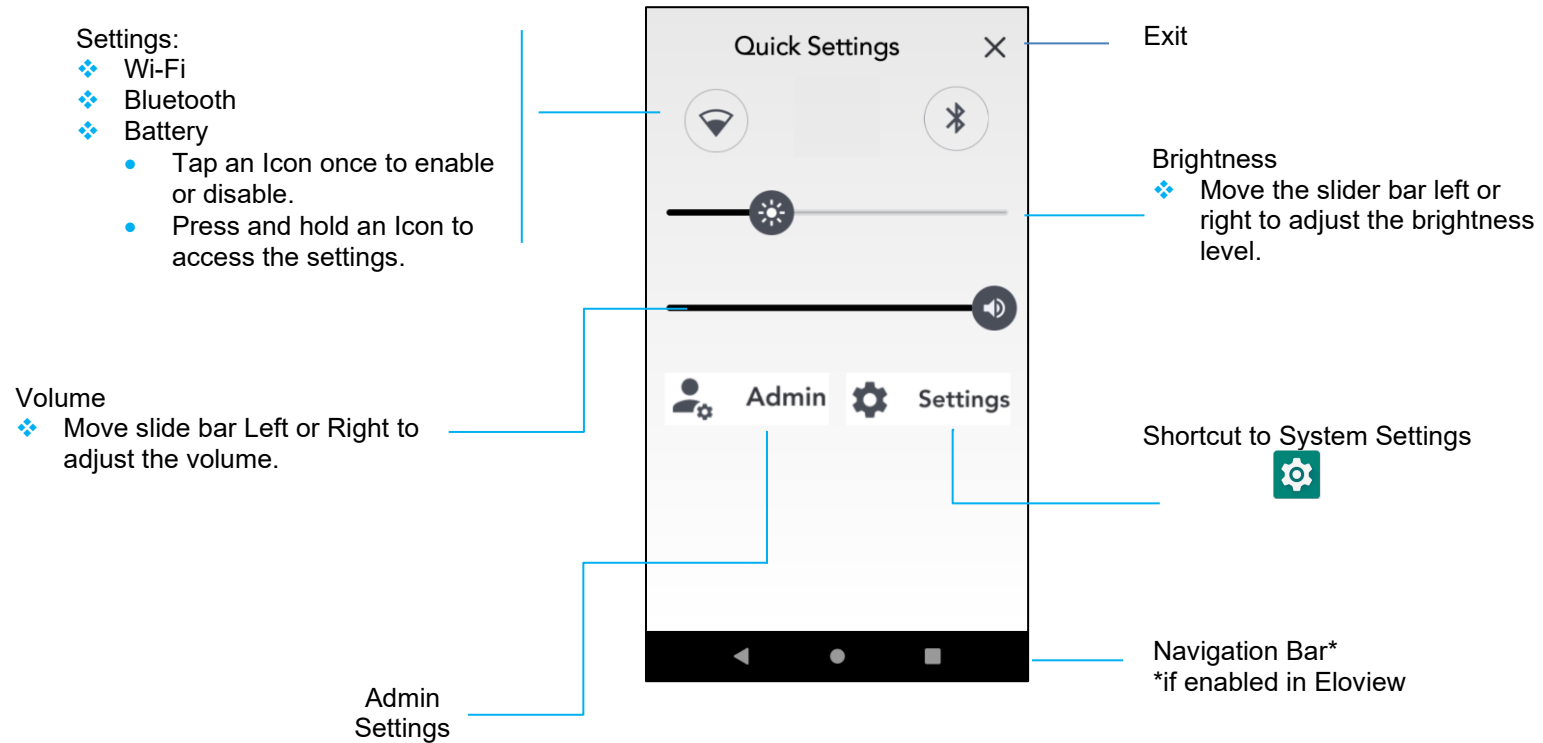

Screen Lock and Home Screens – GMS

Note: The images below may appear different from the actual computer.

Lock Screen

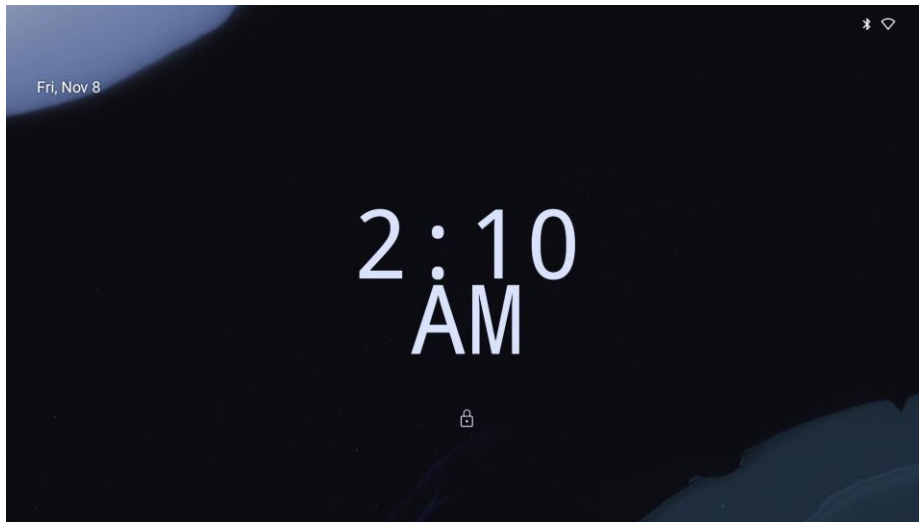

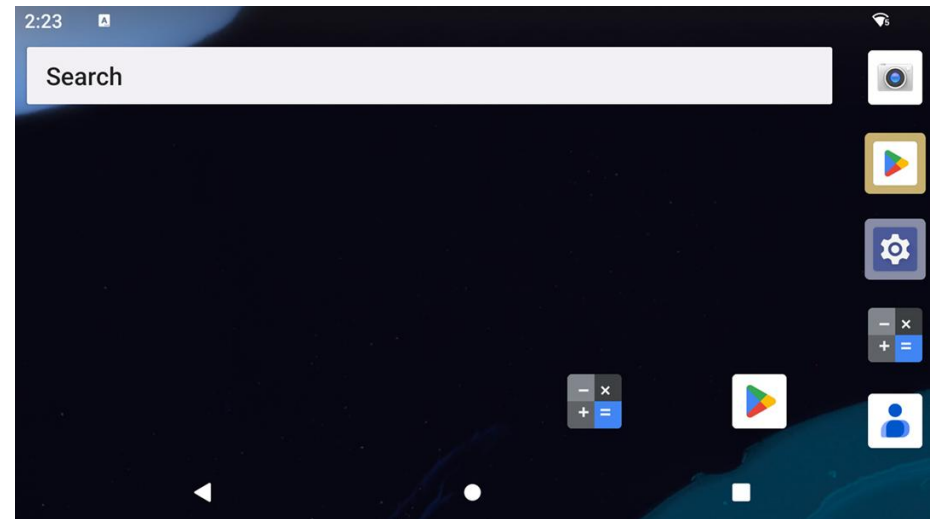

Home Screen



Home Screen is the starting point for navigating the Elo Pay 15-inch Tap to Pay device. You can place your favorite apps and widgets here.

- To unlock the screen to **Home Screen**, swipe up on the **Lock Screen**.
Note: The default security is Swipe. Refer to the Security settings section in this manual for advanced settings.
- To Lock the screen, press the power button once.

Navigation Bar

-  **Recent App** - Return to the previous page.
-  **Home** - Return to the home screen.
-  **Back** - Switch between recently used apps.

Notification Panel

The notification panel allows for quick access to setting shortcuts and notification alerts.

Note: The images below may appear different from the actual device.

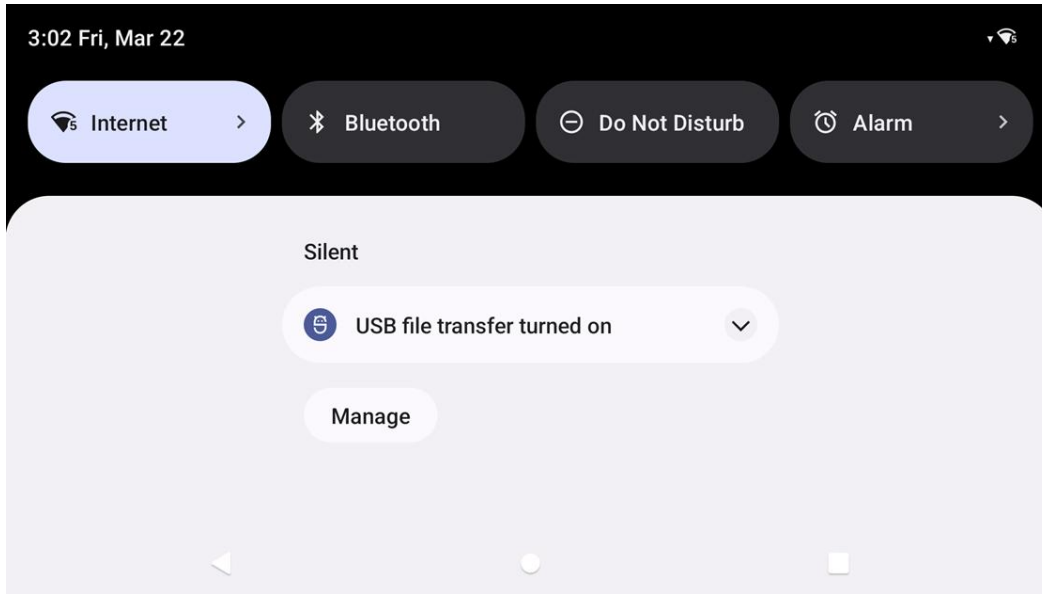

To open the Notification Panel

- From the **Home Screen**, swipe down from the top of the touch screen.
- To clear a single notification alert, drag the notification all the way to the left or right.
- To clear all notification alerts, tap "**Clear**".
- To customize notification alerts, drag the notification halfway to the left or right then tap  setting.
- To exit, tap the **Navigation Bar** feature or swipe up the notification alert menu.

Quick Access Panel

Access Panel allows for quick access frequently used settings, Brightness, and a shortcut to System Settings.

Note: The images below may appear different from the actual computer.

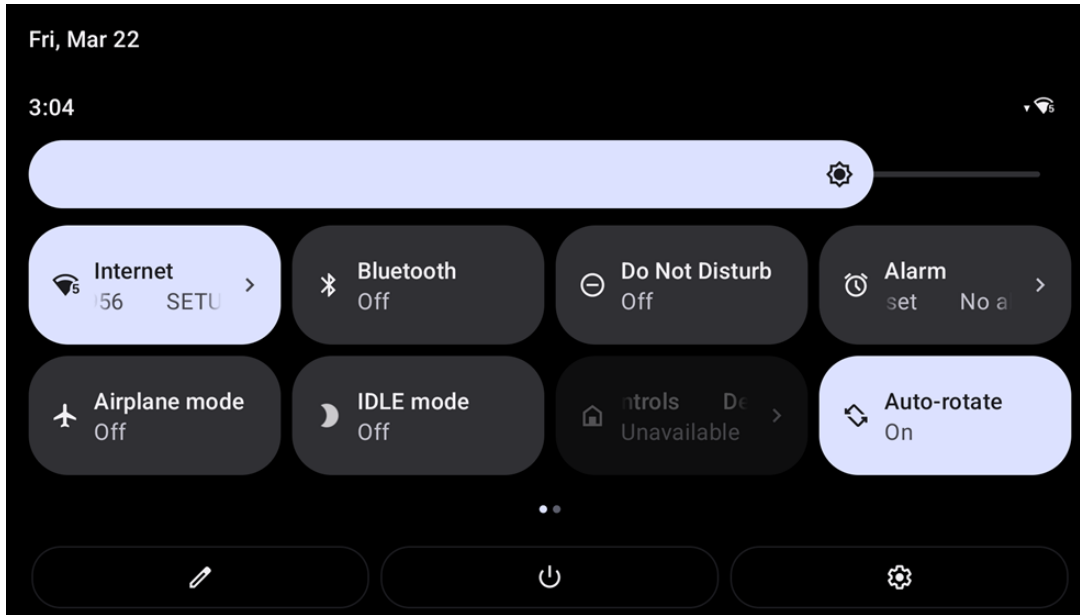

To open the Full Quick Access Panel

- From the **Lock Screen**, swipe down from top of the touch screen once.
- From the **Home Screen**, swipe down with two fingers from top of the touch screen.
- If the Notification Panel is open swipe down from the **Quick Settings bar**.
- For additional shortcut Icon's swipe screen from right to left.
- Tap **Navigation Bar** to exit.

Application Drawer & Google Application

The application drawer is a menu containing all of the applications installed on the device including System Settings. This is different from the Home Screen, as it contains every app installed and cannot be customized.

Note: The images below may appear different from the actual computer.

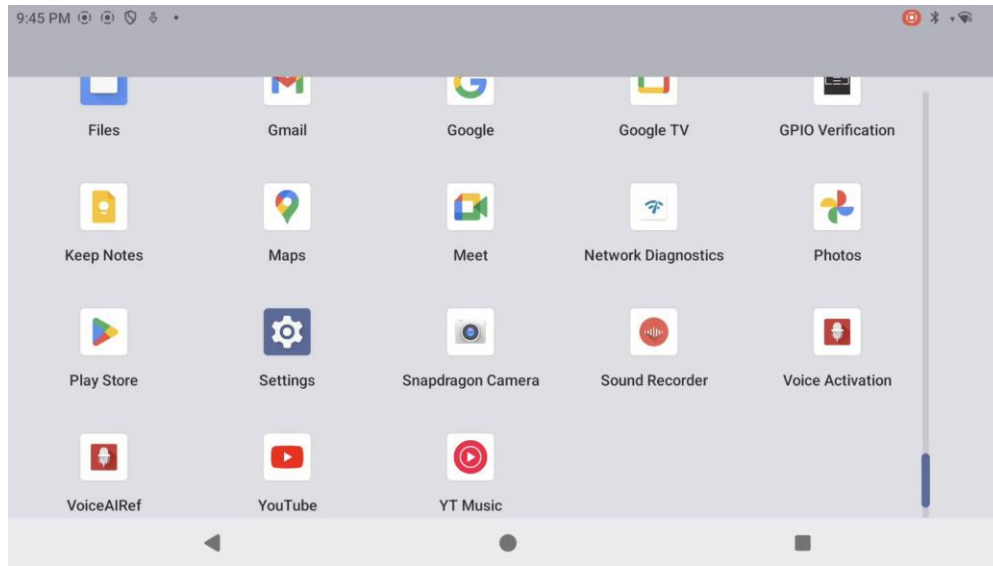

Google Application

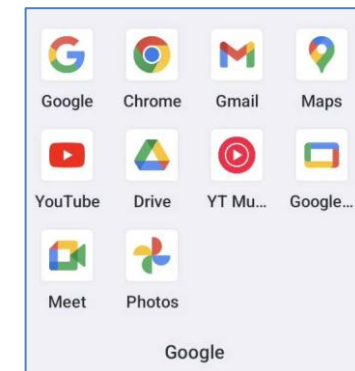

To open the Application Drawer (Manager)

- Swipe up the **Navigation Bar** from the **Home screen**.
- To open an application, tap once.
- To exit from the **Application Drawer**, tap the Navigation Bar or swipe down.

Customize and add a shortcut to the Home Screen.

Note: The images below may appear different from the actual computer.

- From the **Application drawer**, press and hold an app or (Icon) then drag the Icon to move the app to the **Home Screen**.
- Drag the Icon into new location and release.

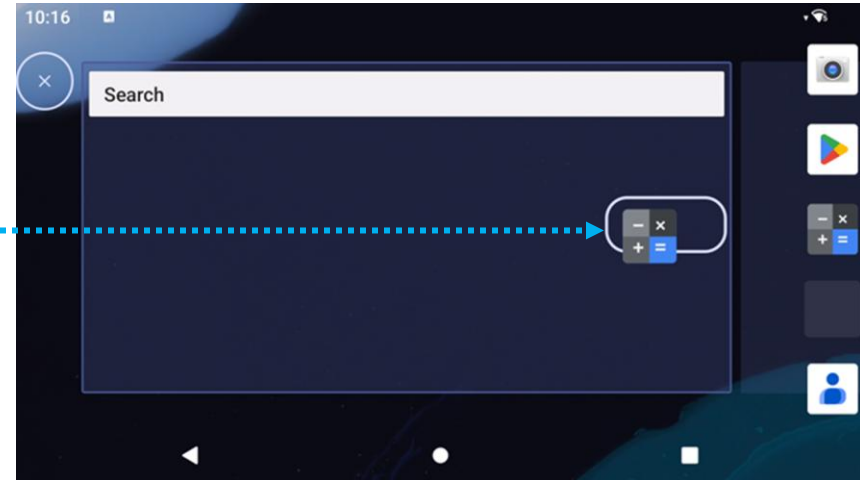
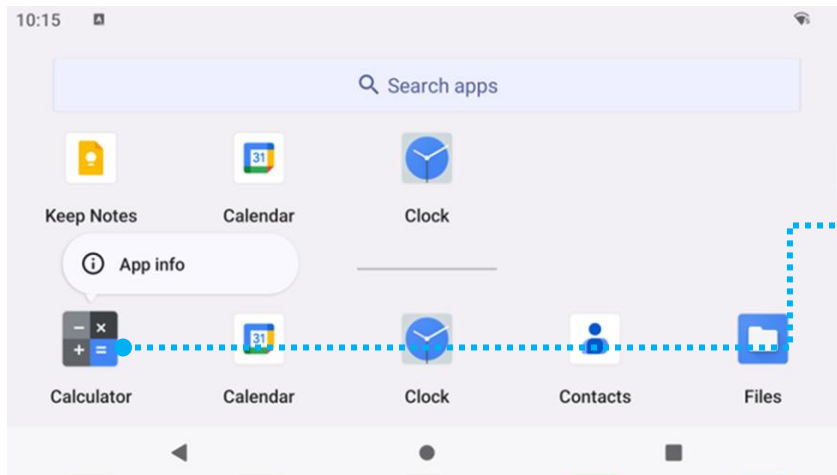

- To cancel, drag the icon to **"X Cancel"**.
- To remove a shortcut Icon from home screen, press and hold the Icon then drag the Icon to **"X Remove"**.
- To uninstall an app, press and hold then drag the icon to **"Uninstall"**.

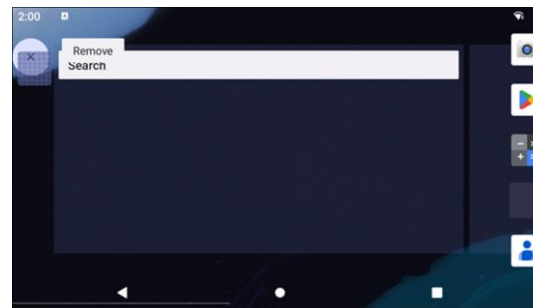
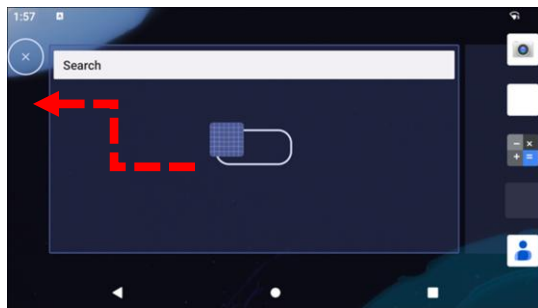

Section 3

System Settings



The System Settings menu allows you to control most aspects of your device - everything from establishing a new Wi-Fi or Bluetooth connection, to installing a third-party onscreen keyboard, to adjusting system sounds and screen brightness.



Network & Internet

The Network & Internet application allows you to access Wi-Fi, Airplane Mode, Mobile plan, Hotspot, Tethering and Advanced settings of Data Saver, VPN and DNS.

To set up Network and Internet, enter  [Settings](#) → [Network & Internet](#) →

WLAN



- Tap **Internet**.
- Tap **WLAN** to enable .
- From the list, select a wireless network.
- When prompted enter the network password.
- Tap **Connect**.



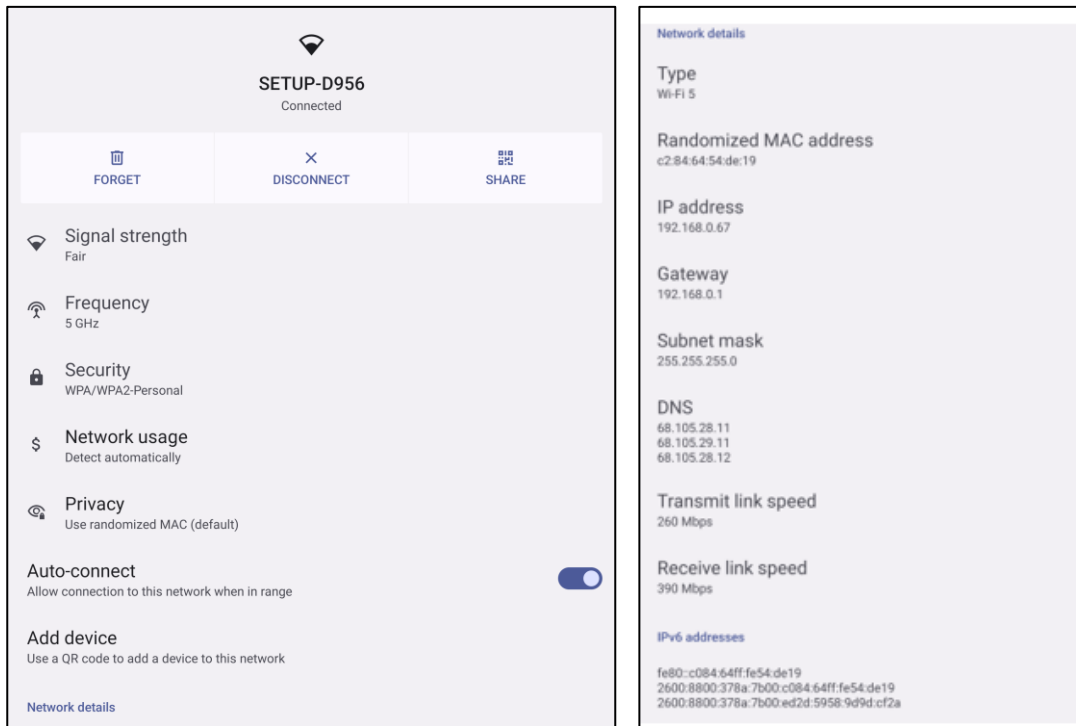

For additional Network detail information's (IP address, Security, Frequency and Advanced), tap  setting of the network (e.g. SETUP_D956).



Joining Wi-Fi using QR code

- From the list of saved Wi-Fi scroll down and tap  Add network .
- Tap  (QR code) icon to the right of Add network.
- Position the viewfinder over the QR code on another device.



Sharing Wi-Fi using QR code

- Tap  setting of the connected device.
- Tap  (Share) icon.

Enabling Dynamic Frequency Selection (DFS) channels



- From the Wi-Fi settings page, select Wi-Fi preferences
- Select Advanced
- Enable or Disable the DFS selection option
- The following channels are supported:
Channel 52, 56, 60, 64, 100, 104, 108, 112, 116, 120, 124, 128, 132, 136, 140, 144

Disconnecting a connected Wireless Network

- Tap  setting of the connected device.
- Tap  (FORGET) icon to disconnect.

Ethernet LAN (Gigabit)

Note: To connect the Elo Pay 15" "Tap-to-Pay" to Ethernet, just connect the cable to the RJ45 Jack. When available, the Elo Pay 15" "Tap-to-Pay" will automatically prioritize the ethernet connection. If the Elo Pay 15" "Tap-to-Pay" does not, please follow the steps below.

- Place the Elo Pay 15" "Tap-to-Pay" into the Elo Home APK.
- Set Wi-Fi to disable.
 - Go to Wi-Fi settings, tap **Use Wi-Fi** to disable .
- Tap **Ethernet**.
- Tap toggle switch to enable .

Airplane mode

This will disable all of the wireless transmission functions. Including cellular, Wi-Fi, and Bluetooth.



- To enable , tap **Airplane mode**.

Hotspot & tethering

Wi-Fi hotspot

This feature is for sharing Internet network connection with another device using Wi-Fi.

Note: The Elo Pay 15" "Tap-to-Pay" must be connected to Wi-Fi. See *Network & Internet connection on this user manual*.

- Tap **Hotspot and tethering**.
- Tap **Wi-Fi hotspot**.
- Tap toggle switch to ON .
- Tap  QR code.
- The QR code is for another device to scan the password for easy connect.

- To enter manually the password, tap **Hotspot password**.

USB tethering

This feature is for sharing Internet connection to another device using a USB cable.

Note: The USB cable must be connected first from Elo Pay 15" "Tap-to-Pay" to another device or PC. See *Connected device → USB on this user manual*.

- Tap **Hotspot and tethering**.
- Tap **USB tethering**, to enable .

Bluetooth tethering

This feature is for sharing internet network connection to another device using Bluetooth.

Note: The Bluetooth must be paired first from Elo Pay 15" "Tap-to-Pay" to another device or PC. See *Connected devices → Bluetooth on this user manual*.

- Tap **Hotspot and tethering**.
- To enable , tap **Bluetooth tethering**.

Data Saver

This feature is for saving data if the internet network connection is on a metered device..

Note: The Bluetooth must be paired first from Elo Pay 15" "Tap-to-Pay" to another device or PC. See *Connected devices → Bluetooth on this user manual*.

- Tap **Data Saver**
- To enable , tap **Use Data Saver**



Connected devices

The Connected devices application allows you to pair Bluetooth devices, NFC, and USB (Tethering File transfer MIDI and PTP)

To setup, enter  [Settings](#) → [Connected devices](#) →

USB

Note: To activate the USB settings, connect the USB cable from the Elo Pay 15" "Tap-to-Pay" to another device or PC. Once the Elo Pay 15-inch Tap to Pay detects the external computer, it will become available in the USB preference settings.

- Tap USB.
- From USB Preferences under USE USB FOR choose and tap a feature to enable.

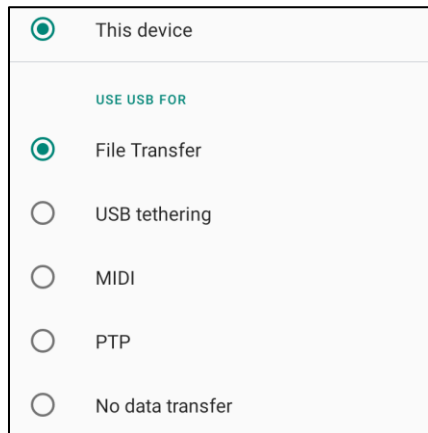

- ❖ **File transfer** – This will share Elo Pay 15" "Tap-to-Pay" internal and SD shared storage.
- ❖ **USB tethering** – This will share internet network connection.
- ❖ **MIDI** - Musical Instrument Digital Interface.
- ❖ **PTP** - Picture Transfer Protocol.
- ❖ **No data transfer** – (Default Setting) No data will be transferred even if the USB cable is connected.

Bluetooth

Note: Make sure the BT device is on and is discoverable.

- Tap **Connection preferences**.
- Tap **Bluetooth**.
- Tap toggle switch to ON .
- Tap **+ Pair new device**.
- From Available devices screen, tap a device to pair.
- When a pairing request message appears.
 - Verify the pairing number is the same.
 - If the pairing requests a PIN, enter the PIN.

- Tap **PAIR**, to connect.
- When the Bluetooth device is successfully connected to Elo Pay 15" "Tap-to-Pay", the connection will show as Active or Connected.

Unpair a paired Bluetooth Device

- Navigate back to 'Connected devices' screen, from **AVAILABLE MEDIA DEVICES** or **PREVIOUSLY CONNECTED DEVICES**.
- Tap  settings of the connected device (e.g. JBL Flip 3).

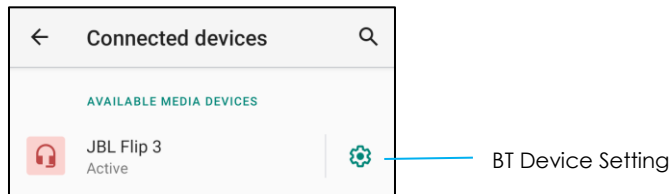

- In the settings menu, it is possible to **DISCONNECT**, **FORGET** (to unpair the device) and to enable and disable Phone calls, Media audio and Contact sharing.

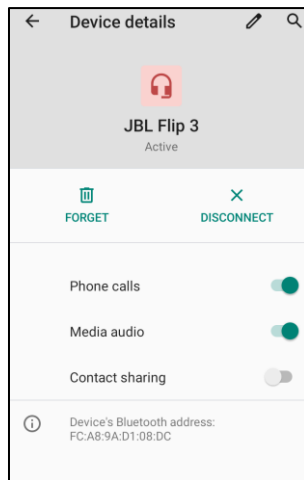

Cast

This allows to mirror the Elo Pay 15-inch Tap to Pay display onto a wireless display device (e.g. Smart TV).

Note: Make sure the wireless display capable device and Elo Pay 15" "Tap-to-Pay" are on the same wireless network. See *Network & Internet connection on this user manual*.

- Tap **Connection preferences**.
- Tap Cast.
- Tap  3-dots menu.

- Tap **Enable wireless display** to begin scanning for compatible displays.

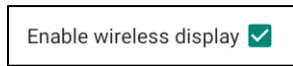

- From the list, tap a wireless display (e.g. TV). From the Wireless Display device (TV), if promoted tap **Allow**.

Disconnect and forget a connected wireless display

- To stop the device from casting, tap the connected wireless display (e.g. TV).
- Tap **DISCONNECT**.



To forget a device

- Tap  setting of connected wireless display.
- From wireless display options screen, tap **FORGET**.

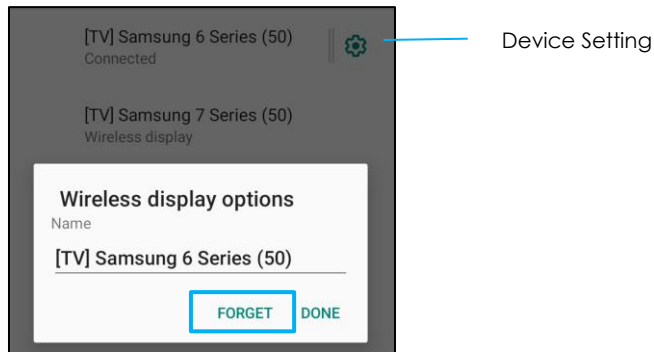

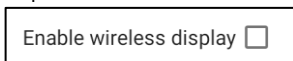

To stop scanning available wireless display to cast

- Tap  3-dots menu.
- Tap **Enable wireless display** to be unchecked



Printing

Note: Make sure Elo Pay 15" "Tap-to-Pay" and printer are connected to the same network.

- Tap **Connection preferences**.
- Tap **Printing**.
- Tap **Default Print Service**.
- Tap toggle switch to ON .
- Tap  3-dots menu.
- Tap **Add printer**.

To add a printer using Wi-Fi printer:

- Tap **Wi-Fi direct printing** to enable .
- If prompted, tap '**ALLOW ONLY WHILE USING THE APP**' to allow the device.
 - Tap **Wi-Fi Direct printers** to start searching for a Wi-Fi printer to add.
 - Tap the printer's name to connect.

To add a printer entering IP address:

- Tap **Add printer by IP address**.
- Enter the printer's IP address.
-

Files received via Bluetooth

This menu will show a list of all the files that have been transferred via Bluetooth.

PoE Power Manager

When Power over Ethernet is being used, the PoE power manager allows the ability to enable and disable available features. To enter the power over ethernet setting, navigate to settings → Connected devices → Connection preferences → PoE power manager.

Note:

1. DO NOT power by POE and DC power brick simultaneously.
2. 51W is the maximum available power to the system when using the PoE module. PoE Power Management setting page will not be displayed when 51W power is detected.

POE < 25.5W	10" Standard	15" Standard	22" Standard
Bluetooth	Enable	Enable	Enable
WiFi	Disable	Disable	Disable
USB 3.0 Type A	Disable	Disable	Disable
USB 3.0 Type C	Disable	Disable	Disable
Edge Connect Ports	Disable	Disable	Disable
GPIO	Disable	Disable	Disable
External Display	Disable	Disable	Disable
Brightness Level	80%	80%	70%



3. POE IEEE 802.3af PSE is insufficient for optimal performance. Not recommended for use.
4. POE++ IEEE 802.3bt PSE is recommended.
5. POE+ IEEE802.3af PSE can only provide approximately 25.5W of power. The system will default disable I/O mostly. Users must manually select and enable the required I/O as below (upper table).
6. When using the POE module, USB-C max power output is 15W.

POE = 51W PoE++ (802.3bt)	10" Standard	15" Standard	22" Standard
Bluetooth	Enable	Enable	Enable
WiFi	Enable	Enable	Enable
USB 3.0 Type A	Enable	Enable	Enable
USB 3.0 Type C	Enable	Enable	Enable
Edge Connect Ports	Enable	Enable	Enable
GPIO	Enable	Enable	Enable
External Display	Enable	Enable	Enable
Brightness Level	100%	100%	100%

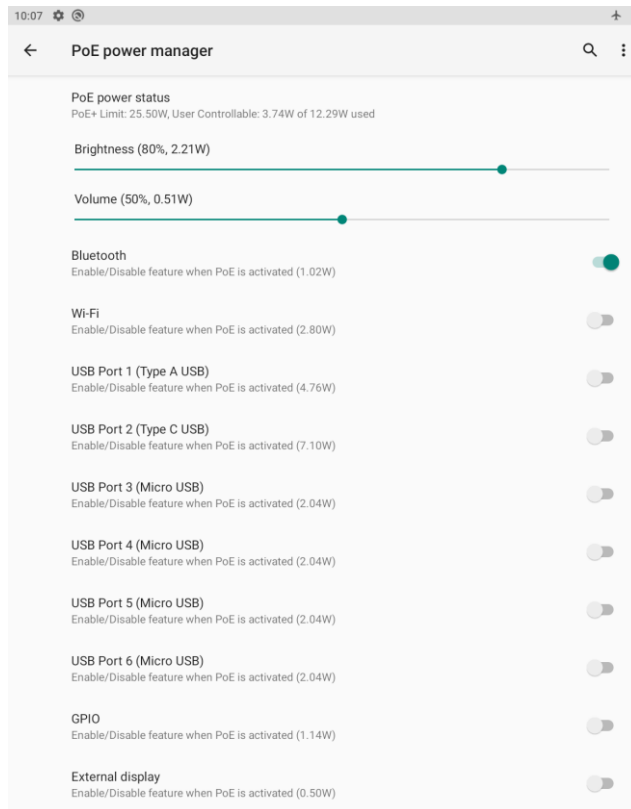

NFC

To enter the NFC setting, navigate to Android settings → Connected devices → Connection preferences → NFC

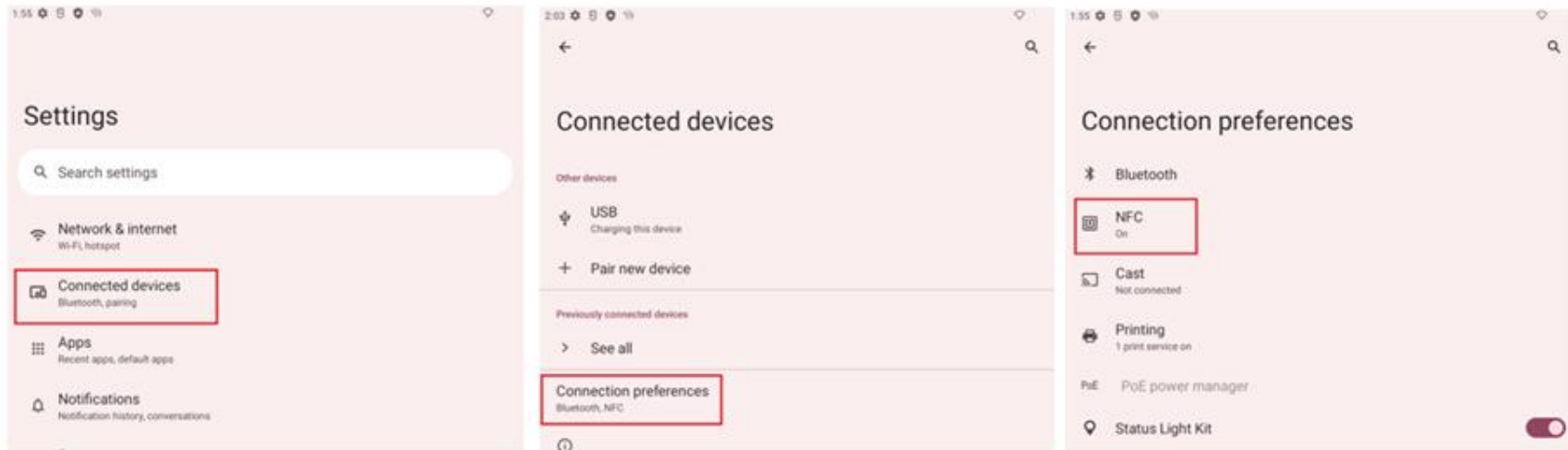



Apps & Notifications

App & Notification settings are to streamline app alerts by changing which apps send notifications and how the notifications alert you.

To manage App & Notification, enter  [Settings](#) → [App & Notification](#)

Setting notifications

- In the Recently opened apps, tap **SEE ALL APPS** or **App info**.
- From App Info screen tap an App to set the notification (e.g. Keyboard).
 - ❖ In the App property settings you can also **DISABLE**, **ENABLE**, and **FORCE STOP** the app.

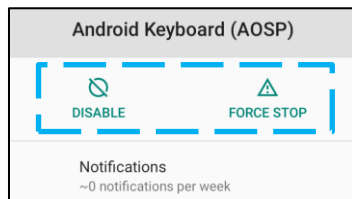

- To enable or disable notifications, tap **Notifications**. Then select **Show notifications**.

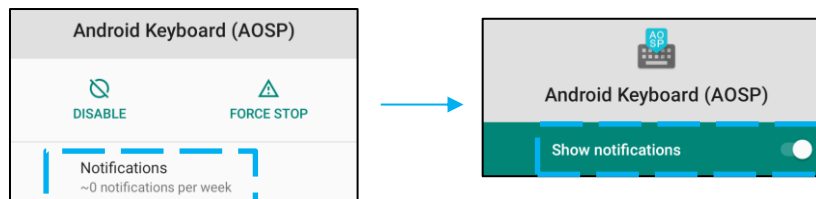

- To add a dot for unread notifications, tap **Advanced** then tap **Allow notification dot**.

Resetting app preferences

This will not lose any app data.

- Tap  3-dots menu from App Info screen.
- Tap **Reset app preferences** then tap **RESET APP**.

Setting Permission manager to an application

- To manage a preference's permissions to an app (e.g. **Keyboard**), tap **Permissions**.
- To allow a permission to an application, tap an app from **DENIED** menu.
- To deny a permission to an application, tap an app from **ALLOWED** menu.

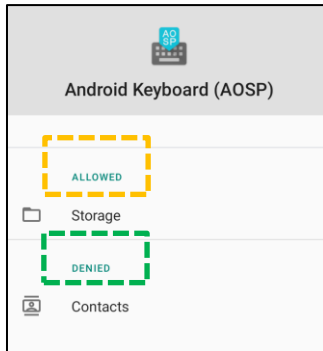

Setting notifications in the lock screen

- To set up notification in the lock screen from Apps and notification screen, tap **Notifications**.
- Tap **Notification on lock screen**. Then follow on-screen instruction on how notifications appear in the lock screen.

For additional settings

- Tap **Advanced**.
- Tap a feature to enable or disable.

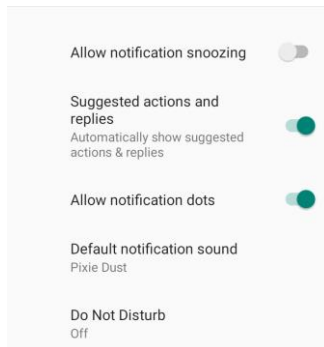

Setting Permission manager on apps using storage, phone, and location

- To give permission to an app, tap **Permission manager** from **Apps and notifications** screen.

- In the menu of permission manager, tap an app to manage that app's permissions (e.g. **Camera**).
- From the camera properties, choose an app to manage.
- To allow a permission to an application, tap an app from **DENIED** menu.
- To deny a permission to an application, tap an app from **ALLOWED** menu.

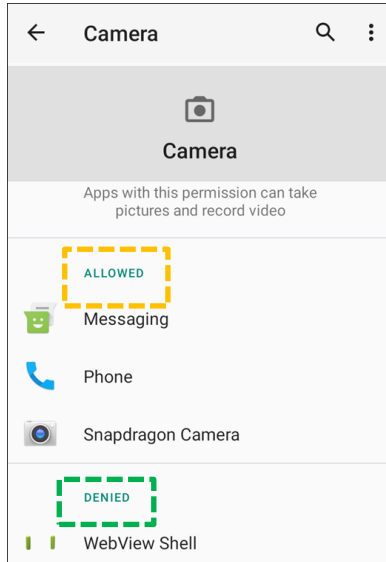

Setting Emergency alerts



- Tap **Advanced** from the **Apps and notifications** screen.
- Tap **Emergency alerts**.
- From the menu of alerts, tap a feature (e.g. **AMBER alerts**) to enable or disable.
- For Sound and Vibration settings, tap **Vibration** to enable or disable under **Alert Preferences**.
- For Alert reminder settings, tap **Alert reminder sound**.



The Display application manages the screen's display settings.

To modify Display settings, enter  [Settings](#) → [Display](#) →

Auto Idle mode

- Tap **Auto idle mode** to enable  or disable .
- When enabled, the backlight will turn off between the hours of 00:00 and 06:00 daily.

Brightness Level

- Tap **Brightness level**.
- Move the slider bar right or left to adjust the screen's brightness.



Dark theme

- To switch screen theme between dark (black color) or light (white color), enable  or disable .

Night Light Feature

This feature will tint the screen to amber. This makes easier to look at the screen or read in dim light.

- Tap **Night Light**.
- Tap **TURN ON NOW**.
- To adjust intensity, move the slider bar right or left.

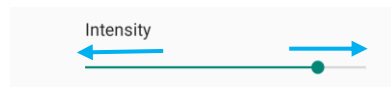

- To disable, tap **TURN OFF NOW**.

Customizing a time schedule

- Tap **Schedule**.
- Select **Turn on at custom time**.
 - ❖ Tap **Start time** to set the time (for example at 10:00PM).
 - Tap **OK** to execute.
 - ❖ Tap **Enter time** to set the time (for example at 6:00AM),

- Tap **OK** to execute.

To disable the time schedule

- Tap **Schedule**.
- Tap **None**.

Wallpaper

- Tap **Wallpaper**.
- Select a wallpaper from the following options.
 - ❖ Live Wallpapers
 - ❖ Snapdragon Gallery → Download – Picture – Screenshot
- Select an image or picture you want as a wallpaper from the folders.
- Tap **SET WALLPAPER**.



Advanced

Screen timeout

- Tap **Screen timeout**.
- Select the time limit from the following option.

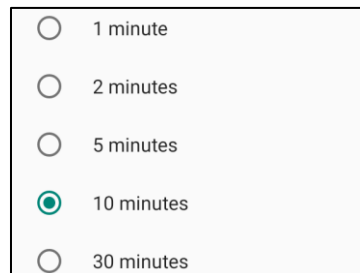
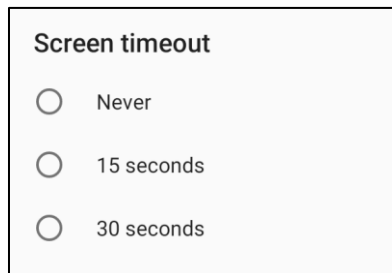

- Tap to save.

Auto-rotation screen

- Tap **Auto-rotation screen** to enable or disable.

Font size

- Tap **Font size**.
- Move the slider bar left or right to adjust the text size.

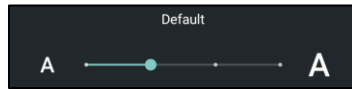

Display size

- Tap **Display size**.
- Move the slider bar to left or right to adjust the screen size.

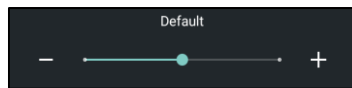

Screen saver

- Tap **Screen saver**.
- Tap **Current screen saver** to make changes to the current settings.

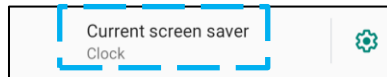

- Select a screen saver from Clock, Colors, Photo Frame, and Photo Table.
- For additional clock, Photo Frame, and Photo Table screen savers, tap  setting.

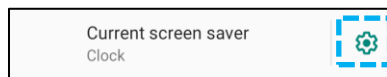

- To activate Screen saver, tap **START NOW**.

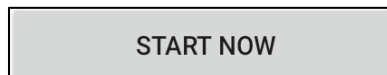

External Screen Orientation

- Tap **External Screen Orientation** to change the orientation of the second screen.
- Select the orientation from the following option.

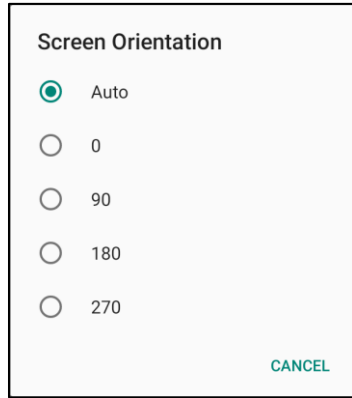

A screenshot of a dialog box titled "Screen Orientation". It contains five radio button options: "Auto" (selected), "0", "90", "180", and "270". A "CANCEL" button is located at the bottom right of the dialog.

- Tap to save.

Screen Orientation

- Tap **Screen Orientation**.
- Select the orientation from the following option.

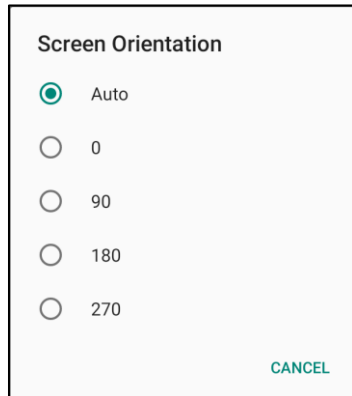

A screenshot of a dialog box titled "Screen Orientation". It contains five radio button options: "Auto" (selected), "0", "90", "180", and "270". A "CANCEL" button is located at the bottom right of the dialog.

- Tap to save.

Screen Density

- Provides the ability to change between 160 MDPI or 240 HDPI



Sound

The sound application is to manage audio, vibration and Do not Disturb features.

To modify settings, enter  [Settings](#) → [Sound](#) →

Volumes

- To decrease or increase the following sound volume, drag slider left or right.

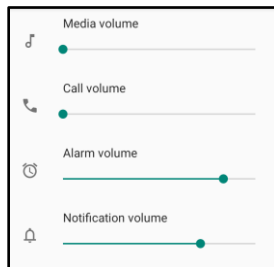

Do not Disturb

- **Tap Do not Disturb.**
- Tap **TURN ON NOW**, to enable Do not Disturb,
 - ❖ To manage settings, tap a feature you wish to manage and follow on-screen instructions to complete the set up.

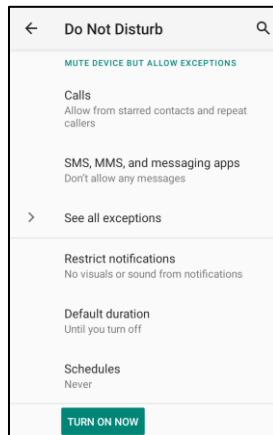

- To disable, tap **TURN OFF NOW**

Shortcut to Prevent Ringing

- Tap **Shortcut to prevent ringing**.
- Tap toggle switch to  enable.
- Select from the following options.

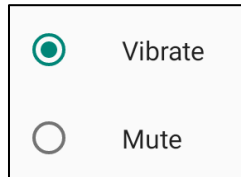

- To disable , tap toggle switch.

Default Notification Sound

- Tap **Default notification sound**.
- Select a sound from the list (e.g. Pixie Dust) and tap **OK** to save.

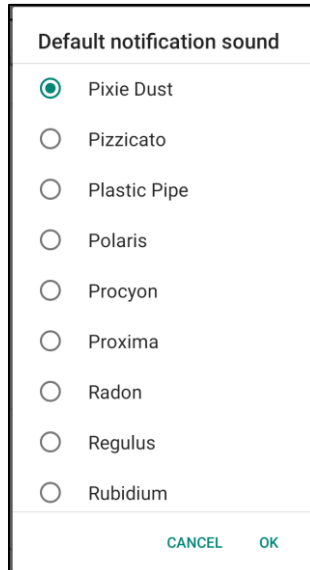

Default Alarm Sound

- Tap **Default Alarm sound**.
- Select an alarm sound from the list (e.g. Cesium) and tap **OK** to save.

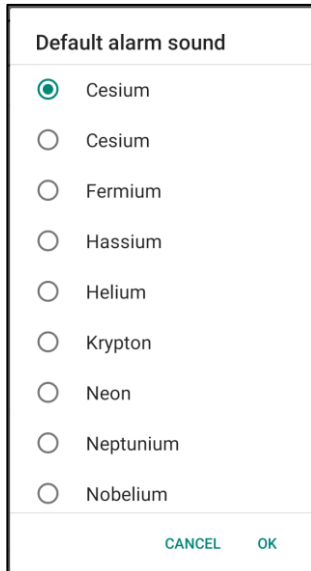

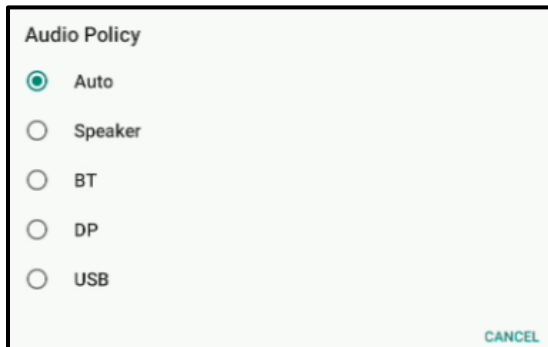

Audio Policy

- Select to audio output port.
- Default is Auto



Advanced

- To enable  or disable  on the following features below, tap a feature.

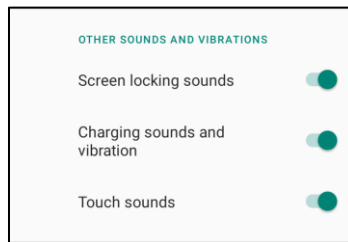



Storage



To manage Storage, enter  [Settings](#) → [Storage](#) →

Internal Shared Storage

- To check the status of internal memory storage, tap **Internal Shared storage**.

Storage Manager

This feature is to help free up storage space, storage manager removes backed up photos and video from the device.

- To enable  or disable , tap **Storage manager**.
- To make changes to set days on removing photos and videos, tap **Remove photos & Videos**.
 - ❖ Select from the options below.

Over 30 days old
Over 60 days old
Over 90 days old

- Tap **Back** to exit.

SD card

- To manage SD card, tap **SD card**.
- To safely eject SD card, tap  eject.
- To remount the SD card, tap SD card.
- Tap MOUNT.

Wakeup Source

The Wakeup Source applications allows you to program the “Touch Screen” to wake up the device from sleep or idle mode.

To modify the settings, [enter !\[\]\(9b800325684b184be8e88ceef387e61b_img.jpg\) Settings → Wakeup Source →](#)

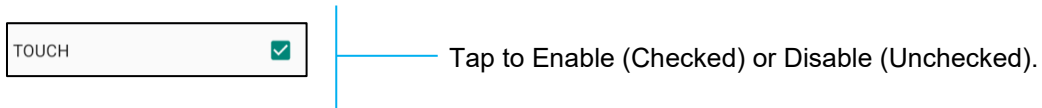

If the device is touched within 3 seconds of going to sleep, the device will wake up even if the wake on touch option is disabled.



The Privacy application is to give you control over what permissions of applications can have.

To manage permission, enter  [Settings](#) → [Privacy](#) →

Permission Manger

This is to grant permission of an App that uses storage, phone, and location.

- To manage permissions to an app, tap **Permission manager**.
- From the menu of permission manager, tap an app you wish to manage (**e.g. Camera**).
- From the camera property shows what applications has camera permissions.
- To allow a permission to an application, tap an app from **DENIED** menu.
- To deny a permission to an application, tap an app from **ALLOWED** menu.

Show passwords

This will display character briefly as you type a password.

- To enable  and disable  , tap **Show passwords**.

Lock screen

This will show all notification content in the lock screen.

- To enable  and disable  , tap **Lock screen**.

Autofill service from Google

This will allow the user to save passwords, credit cards and addresses in order to quickly fill out online forms.



Location

To modify Locations settings, enter  [Settings → Location](#)

- Tap **Location**.
- To enable or disable, tap **Use location**

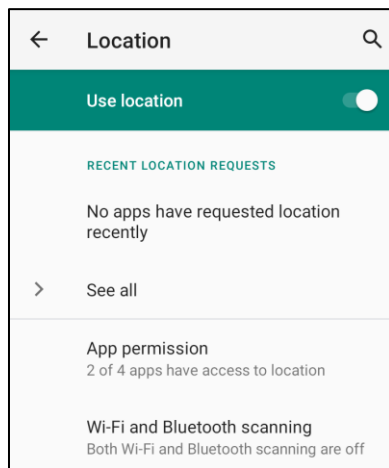

- For apps have requested location recently, **tap See all**.
- To update permission, tap **App permission**.
- To scan for Wi-Fi networks and Bluetooth, tap **Wi-Fi and Bluetooth scanning**,
Note: This feature allows apps and services to scan for Wi-fi networks and Bluetooth anytime. This can be used to improve location-based features and services.



Security & Privacy

The security & privacy application is to manage App security, device lock and permissions.

Security

App Security

- Tap App Security.

Device Unlock

- Tap Device Unlock to manage screen lock, face unlock.
- Screen lock
 - Choose a new screen lock

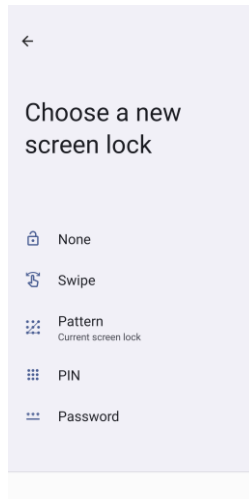

- Follow the instruction to set the screen lock
- Face Unlock
 - Choose a screen lock

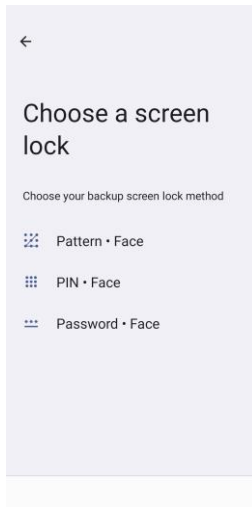

- Unlock your face

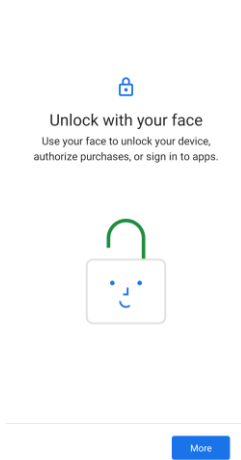

- Follow the instruction on the screen to set up Face Unlock

Account security

- Tap account security
- To set the security checkup and password checkup.

Device Finders

- Tap Device Finders

- To set **find my device**, to enable use Find My Device

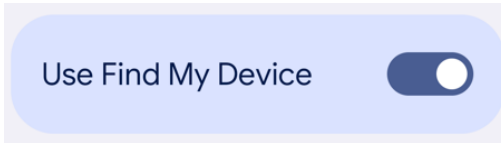

- To set **Unknown tracker alerts**, to enable Allow alerts

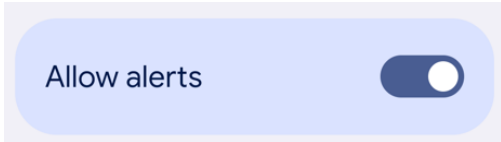

System & updates

- Tap **Systems & updates**
- To set the system update and backup

Privacy

The Privacy application is to give you control over what permissions of applications can have.

Permission Manger

This is to grant permission of an App that uses storage, phone, and location etc.

- To manage permissions to an app, tap **Permission manager**.
- From the menu of permission manager, tap a permission type which you wish to manage (**e.g. Camera**).
- To change an app's permission, tap the app, then choose your permission settings
- To change the permission setting, tap it, then choose **Allow** or **Don't allow**.
- You may be able to choose

All the time: For location only. The app can use the permission at any time, even when you're not using the app.

Allow only while using the app: The app can use the permission only when you're using that app.

Ask every time: Every time you open the app, it'll ask to use the permission. It can use the permission until you're done with the app.

Don't allow: The app cannot use the permission, even when you're using the app.

Privacy dashboard

This shows which apps recently used permissions

Ads

Manage device data used to show your ads.

Data sharing updates for location

Review apps that changed the way they may share your location data

More security & privacy

Supports additional security and privacy settings like app pinning and notifications on lock screen.



Accounts

To add an account, enter  Settings → Accounts

- To set up an account, tap **Account**.
- Tap **+ Add account**.
- Enter an email account.
- Enter an Account type you want to add (**PERSONAL - POP3** or **PERSONAL – IAMP**).
- Follow the on-screen instructions to complete the setup.





Accessibility

The Accessibility is a large on-screen menu to control the Elo Elo Pay 15-inch Tap to Pay device. You can control display, audio & on-screen text and more.

To modify settings, enter  [Settings](#) → [Accessibility](#)

- From the menu, select a feature to change the setting.
- Select to Speak
 - ❖ If enabled, will speak the text word when it is clicked on.
- TalkBack
 - ❖ If enabled, will provide feedback to use the device without having to look at it.
- Text-to-speech output
 - ❖ Will convert text into speech.
 - ❖ There are also option to change the language, speech rate and pitch

- To enable  or disable , tap the feature.
- To adjust slide bar, drag slider right or left.



- For other settings, tap the feature and follow the on-screen instruction to complete the setup.

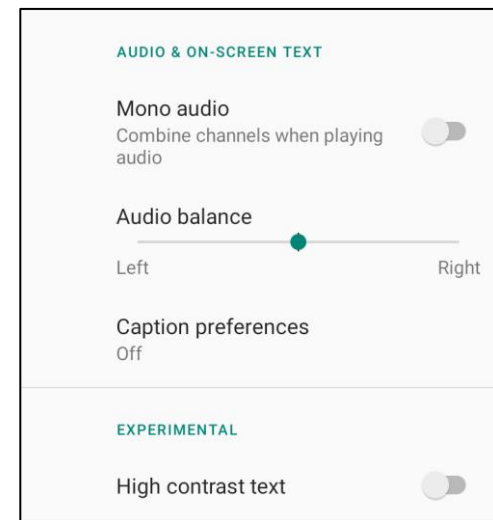
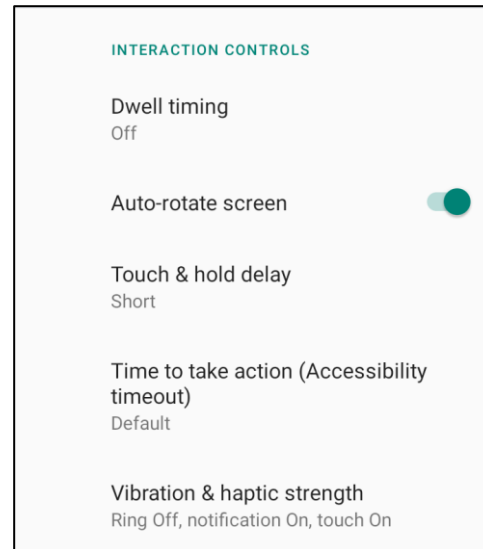
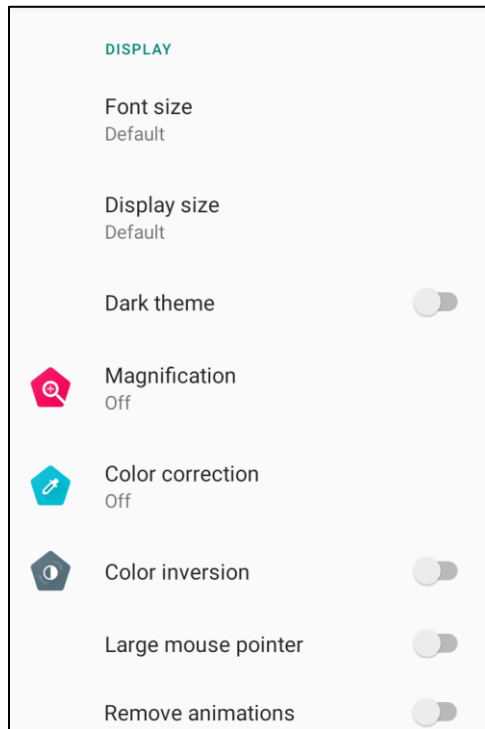



Digital Wellbeing & parental controls



- Digital Wellbeing and Parental controls are available here.

To modify settings, enter  [Settings](#) → [System](#) →

Languages & input

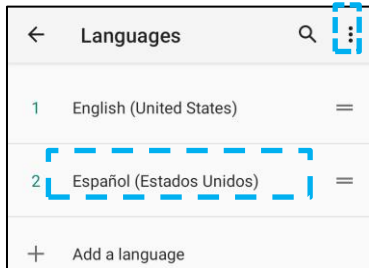
- To change language, tap **Languages & input**.
- Tap **Language**.
- Tap **+ Add a language**, then choose from the list of languages to add (e.g. Espanol).



- After choosing a language, tap  3-dots menu then tap **Remove**.
- To change a language e.g. from English to Espanol, tap English then tap .

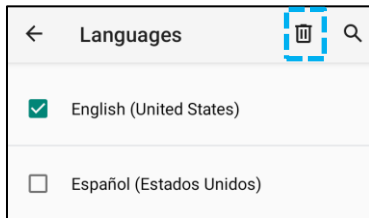

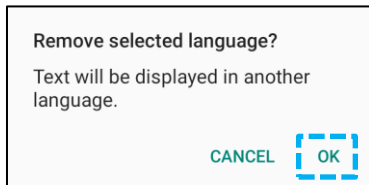

- Tap **OK** to remove selected language.



Gestures

- Tap Gestures.

For camera gesture

- Tap **Jump to camera**.
- Tap **Jump to camera** to enable  or disable .
- ❖ When set to enable, pressing power button twice will activate, the digital camera.

For notification volume gesture

- Tap Preventing ringing
- Tap toggle switch to ON or OFF.

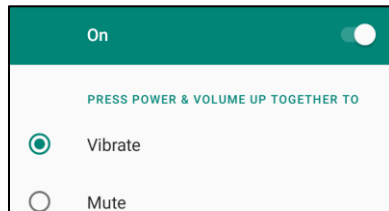

- ❖ When set to Vibrate mode and notification volume is active, pressing power + volume up buttons together, the notification volume will be set to vibrate mode.
- ❖ The vibrate mode icon will also show into status bar.

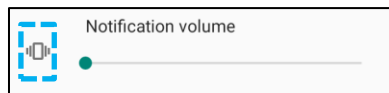

- ❖ When set to Mute mode and notification volume is active, pressing power + volume up buttons together, the notification volume will be muted.
- ❖ The mute icon will also show into status bar.

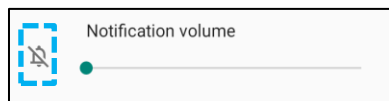

Date & Time

Note: The recommended setting for “**Date and Time**” is to use, “**USE network provided time**”.
And for **Time zone** when is set to “**USE network provided zone**”, you need a sim card to work.

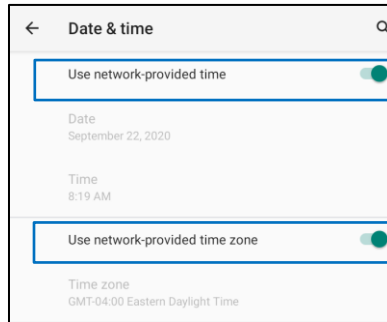

For manual settings:

- Tap **Date & Time**.
- To set Date and Time manually, tap **Use network-provided time**.
- Tap **Date**.
- Tap **Time**.

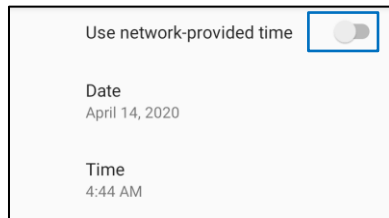

- To set time zone, tap **network -provided time** and select your time zone.

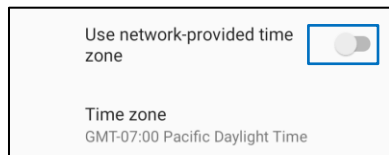

- To set to 12 hours format, tap **Use locale default**.

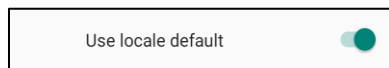

- To set 24 formants, tap **Use 24-hours format**.

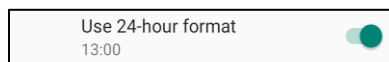

Advanced

Reset options

- To select a following option to reset, tap Reset options.
- From the list, select an item to reset then tap to execute and follow on-screen instruction.

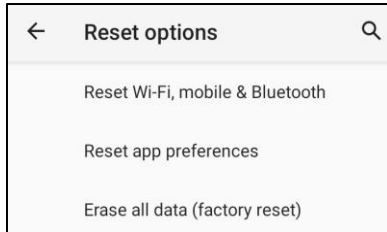

Multiple users

- Tap **Multiple users**.
- Tap toggle switch to  ON.

To switch users

- Tap a user or name from the following option.

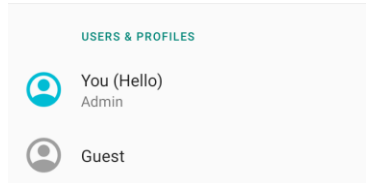

To add user

Note: only admin can add users.

- Tap **+ Add user or profile**.
- To set up apps and contents for the user, tap **User**.
Follow on-screen instructions to complete account set up.
- To set up restriction access to apps and content for the users, tap **Restricted profile**.
Follow on-screen instructions to complete account set up.

To delete guest from the device

- Tap  3-dot menu from **Multiple Users** screen.
- Tap **Delete Guest** from this device.

To rename Admin Profile info

- Tap  admin
- Enter the name.
- Tap **OK** to save.

Developer (Accessing developer option menu)

- To access Developer option menu, go to **About tablet** → **Build number**.
- Tap Build number 7 times. When successfully done you will see the message “You are now a developer”.
- Then go back to →  **System** → **Advanced**.



About tablet

For viewing specific information of Elo Pay 15-inch Tap to Pay device.

To view and modify settings, enter  [Settings](#) → [About tablet](#)

Device name
10in-I-Series-5
Legal & regulatory
Legal information
Device details
Display Size
1200 x 1920
Model
10in-I-Series-5
Model description
i5_in10_std
Android version
14
Device identifiers
IP address
fe80::cb3d:1117:1932:f13c 10.49.1.58
WLAN MAC address
To view, choose saved network
Device WLAN MAC address
1c:ee:c9:64:52:e3
Bluetooth address
1c:ee:c9:64:52:e2
Up time
19:54
Build number
7.000.001.0012+p



Section 4

Operational





About Camera App (Snapdragon)

Camera Features

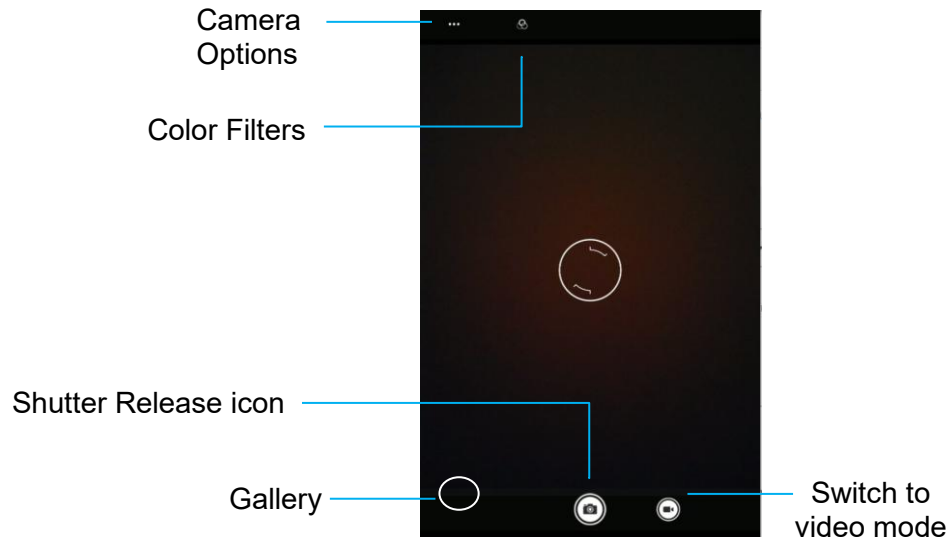

Switch - A switch between Camera to Video.

Camera Options - For selecting the best exposure settings to fit the type of scene being shot. That is, in addition to the amount of light in the scene. HDR mode can be enabled from here.

All other option available by clicking the gearhead icon are listed in the table below.

Shutter Release - For taking picture.

Gallery – For viewing captured picture.

Advanced Settings

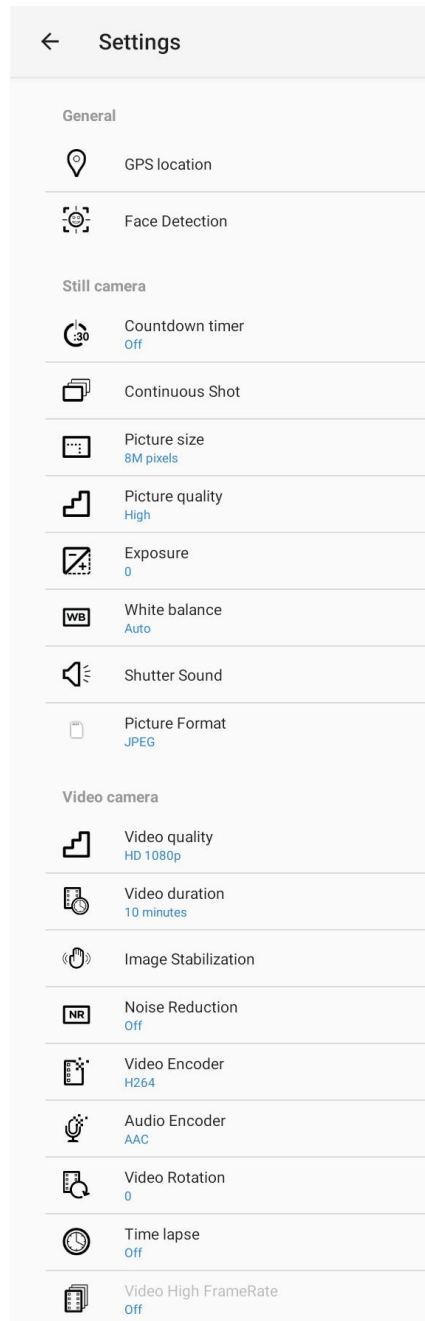



- GPS location will be saved
- Faces will be detected
- Countdown timers supports Off, 2 seconds, 5 seconds and 10 seconds
- Will take continuous shots
- Allows the picture size to be changed.
- Allows user to select the output picture quality
- Ability to change the exposure
- Allows control of the white balance (Auto, Incandescent, Fluorescent, Daylight, Cloudy)
- Enable or disable the shutter sound
- Allows control of the picture format (JPEG or HEIF)
- Allows control of the video quality. (1080p is the native resolution)
- Allows control of how long a video will be taken
- Provide software image stabilization
- Reduces noise that is introduced when taking video.
- Allows control of the video encoder
- Allows control of the audio encoder
- Allows a time lapse at various intervals (up to 24 hours)
- Video high frame rate (FPS) can be enabled. (not available in time lapse mode)

Take a Picture and Record Video

- Tap  Snapdragon camera app to access the Digital camera.
- To change camera and video settings, see features.
- From the switch, located on bottom left side of the Elo Pay 15" "Tap-to-Pay" select one from the following options.





For Panorama, tap  Panorama Icon.

- ❖ To take panoramic pictures, tap  panorama shutter Icon.
- ❖ Slowly move the device across to take a panoramic picture.
- ❖ When finished, tap  stop Icon.





For Video recording, tap  Video Icon.

- ❖ To record videos, tap  capture Icon.
- ❖ To mute and unmute sound while recording, tap microphone Icon.
- ❖ When finished recording, tap  stop Icon



For camera, tap  Camera Icon.

- ❖ To take pictures, tap  shutter release Icon.
- ❖ To enable and disable shutter sound, go to advanced settings. See camera features.
- ❖ To zoom an object or scene place two fingers on the screen together, spreads them apart to zoom in and pinch to zoom out.
- ❖ To auto focus an object or scene, tap touch screen.
- ❖ To view pictures and play recorded videos, tap gallery.
- ❖ To play recorded video, tap  play.

Take a Screenshot









For capturing an image of the screen. The device will automatically save the image in the  File folder application.

- Press the power button for more than 2 seconds and a pop-up screen menu will appear then tap  screenshot.



File Application

The File Manager app helps to manage, delete, print, shares and transfer files between the mobile storage and a computer.





To access pictures, videos, screenshots, audios, downloads, and mobile internal / external storage, go to application drawer.

- Tap  file application from the application drawer.
- Tap  3 lines menu and choose one of the following options.
- Tap  Image Icon for pictures and screenshots.
 - ❖ Tap Camera folder for photos.
 - ❖ Tap Screenshots folder for screenshot images.
 - ❖ Tap  Video for recorded videos.
 - ❖ Tap Camera folder.
 - ❖ Tap  Audio for recorded audios.
 - ❖ Tap  for Downloaded items.
 - ❖ Tap  for mobile internal storage folders.
 - ❖ Tap  for mobile external storage folders.

Delete Files





- To delete files from the folders above, press and hold an item or tap  3 dots menu to select all items in the folder.
- Tap  to delete.
- Tap OK to confirm.

Copy and Move Files

- To copy or move files into new location press and hold an item from the folders above or tap  3 dots menu to select all items in the folder.
- Tap  3 dots menu again and choose "Copy to" or "Move to".
- Tap  3 lines menu and choose from the following options where you want to move or copy the item.
- To create a new folder, tap  3 dots menu.
- Rename the folder.
- Tap Copy or Move to confirm.
- Print File
- Note: To print you must set a printer. See Settings → Connected device → Print.
- To print files from the folders above, tap an item once.
- Tap  3 dots menu and tap Print.

Share Files

Note: Make sure both device Bluetooth are paired. See Connected devices → Bluetooth on this user manual.

- To share files from the folders above, press and hold an item.
- tap  share icon.
- To share via Bluetooth, tap  Bluetooth icon.
- To share via Email, tap  email icon
- For more options hold an item from the folders above.
- Tap  3 dots menu and choose from the following options and follow on-screen instructions.

General-purpose Input/Output (GPIO) Support

The Elo Pay 15" "Tap-to-Pay" supports a GPIO which can be used to connect to peripherals such as a motion sensor.

Elo has an optional GPIO cable (PN: E211544) with flying leads so that it is easy for users to connect their own peripherals.

Pinout of the GPIO cable (PN: E086398):

Red Wire: Pin 1 → 5 Volt output connection

White Wire: Pin 2 → Input connection 1

Green Wire: Pin 3 → Input connection 2

Two Black Wires: Pin 4 and Pin 5 are tied to ground

5V, 200mA is the max voltage and current available via this GPIO port.

G-Sensor

All Elo Pay 15" "Tap-to-Pay" units are equipped with a g-sensor and will rotate the video based on the orientation of the device.

USB – C Settings

Elo Pay 15" "Tap-to-Pay" device supports USB – C video, audio and touch via the USB- C cable.

The Elo Pay 15" "Tap-to-Pay" device can also support power up to an Elo 1502L Touch monitor via the USB – C cable when using the optional Elo 90W power supply.

To enable video output, enter the developer options and click on USB and DP configuration.



- Default mode is DP (4 lanes) & HS-USB (allows for video output and USB2.0 speeds)
 - Note Ethernet speeds will be limited to USB2.0 speeds
- User can change to SS-USB only to allow for higher USB and Ethernet speeds. There is no video output in this mode.
- If the USB protocol is changed, please reset the Elo Pay 15-inch Tap to Pay Device.

About Debug Bridge (ADB) control

Elo Pay 15" "Tap-to-Pay" supports debugging via Wi-Fi/Ethernet or using the USB cable.

Note: For USB debugging, use a USB Type A to Type A cable.

Set Elo Pay 15" "Tap-to-Pay" to (Developer)

- Enter  Settings → About tablet → Build Number.
- Tap Build Number 7 times to enter developer mode.
- Go back to the  Settings → System → Advanced and you will see "**Developer Options**".
- From Developer options on- screen display, enable the option called "**USB debugging**".

To connect via Wi-Fi

Ensure that your computer is online and not behind a firewall.

- Find the IP address (by going to  **Settings** → **Network & Internet** → **Wi-Fi** → Tap the active **connection** → **Advanced** → **IP Address**.
- On your host computer, use the command ADB connect <IP address> to be able to perform ADB actions.

To connect via USB, perform the following steps

- Ensure the USB cable is not connected to the Elo Pay 15" "Tap-to-Pay".
- From the settings, enter Developers Options
- Turn on the "Enable USB Debugging" option
- Plug USB cable (type A) side into the Elo Pay 15-inch Tap to Pay device and (type A) to host PC.
- In the host PC, input "ADB devices" to check if the Elo Pay 15" "Tap-to-Pay" serial number shows up. If it is there, then you have connected successfully.

Optional Flip Stand (Elo Z20 Stand)

Elo provides an optional flip stand kit which supports the Elo Pay 15" "Tap-to-Pay". The following features are available on the flip stand.

USB – C for video output

- DisplayPort, USB and Power Delivery up to 27W
- Supported Elo Touch Monitors: ET1002L, ET1302L and ET1502L

Four USB 3.0 Type A ports

- When using a secondary display, USB speeds will be set to USB2.0 protocol
- The default setting for USB is USB 2.0 protocol.

RJ12 connector which can be used as a cash drawer

- User must choose which setting the RJ12 will be in.
- The available options are 12V or 24V.

Ethernet LAN

- Ethernet download speeds will decrease to ~250Mbps when using the secondary display

Certification information:

The Elo Z20 Stand is not in scope or UL/cUL.

The Elo Pay 15" "Tap-to-Pay" Standard head meets UL/cUL. When it is mounted on the Z20 stand, the unit can be used under UL/cUL certification.

Factory Full Reset

A full factory reset should only be performed if all other recovery methods have failed and all other troubleshooting options. Performing a full factory reset results in loss of data. This option will recover the original factory image state by erasing all data in the main storage on the Elo Pay 15" "Tap-to-Pay".

Note: Performing a factory reset on **bootloader menu**, if you added a Google Account to Elo Pay 15" "Tap-to-Pay" make sure you have your Google credential (Username and password) associated with the Elo Pay 15" "Tap-to-Pay". If you don't have it you will not be able to use the device after reset. This is a security measure that prevents an unauthorized user from using the device if they do a factory reset on the bootloader menu.

To Reset

- Enter  **Settings** → **System** → **Advanced** → **Reset Options**.
- Tap **Erase all data**.
- Under **Erase all data (factory reset)**, tap **Erase all data**.
- Under **Erase all data?**, tap **Erase all data**.
- When successfully done, the device will auto-reboot.

Optional Peripherals

Part Number	Description
E669163	POE++ Module Kit for I-Series 5
E809509	Expansion module kit
E572635	90W Replacement Cable Kit (power supply for a single device with an USB-C powered external display)
E514304	65W Replacement Cable Kit (power supply for a single device without USB-C powered external display)
E134286	Fingerprint Scanner
E673037	RFID reader
E001002	MSR
E644767	Status Light
E384627	2D Barcode Scanner (SE4720)
E245047	2D Barcode Scanner (SE4107)
E201494	2D Webcam
E894719	Speaker
E419081	Edge Connect Audio Adapter



Optional Stands and Mounting Kits

Stands available for the Elo Pay 15" "Tap-to-Pay" models

Display size and weight will limit the mounting angle

Part Number	Description
E307788	Elo Stand 1302L – Black (75mm VESA)
E307974	Elo Stand 1302L – White (75mm VESA) Only works with the 15.6" devices
E143088	Wallmount
E804330	Elo Stand 1902/3-2202/3 – Black (100mm VESA)
E808963	Elo Stand 1902/3-2202/3 – White (100mm VESA)
E509844	Elo Stand 2402/3-2702/3 – Black (100mm VESA)
E510042	Elo Stand 2402/3-2702/3 – White (100mm VESA)
E044356	Tabletop Stand for 22" I-Series (100mm VESA)
E044162	Tabletop Stand for 15.6" Display (Black) (100mm VESA)
E514693	Thinnaby Countertop (15.6" and 22" models)
E514881+E515260	Thinnaby Floor Stand + Base (15.6" and 22" models)
E421137	Wallaby Countertop Stand (15.6" and 22" models)
E421325+E797162	Wallaby Floor Stand + Base (15.6" and 22" models)
E796783	Wallaby Self-Service Countertop Stand
E796965	Wallaby Self-Service Floor Stand
E989127	Wallaby Pro self-service countertop stand
E989314	Wallaby Pro self-service floor stand top (note: complete self-service floor stand requires floor base part E989512 sold separately)
E047458	6" (152.4 mm) Pole Mount Bolt Down Kit
E047663	12" (304.8 mm) Pole Mount Bolt Down Kit
E047864	18" (457.2 mm) Pole Mount Bolt Down Kit
E048069	Pole Mount Floor Stand
E045151	Pole Mount Bracket
E043382	Shelf Mount
E375343	KIT-EMV-BRKT-EDYNAMO
E586981	KIT-EMV-BRKT-RP457C-AUDIO-JACK
E710930	KIT-EMV-BRKT-RP457C-BT-USB
E767356	KIT, Z20-POS-STANDGEN2-15 Only works with the 15.6" devices



Section 5: Technical Support and Maintenance

Technical Assistance

Technical Specifications

visit www.elotouch.com/products
for technical specifications for this device

Support

visit www.elotouch.com/support for technical support

Refer to last page for worldwide technical support phone numbers.

Elo Pay 15" "Tap-to-Pay" Care and Handling

The following tips will help maintain optimal performance of your Elo:

- To prepare for cleaning the touchscreen, power down the device (if possible), or ensure your on-screen software can tolerate false touches while you clean.
- Do not get liquids inside the unit. Do not spray the Elo product directly. Instead, use wet wipes, a sprayed cloth or a dampened cloth with the excess moisture squeezed off.
- Select only non-abrasive cleaning wipes or cloths to avoid scratching touchscreens.
- Avoid highly concentrated alcohol (> 70%), non-diluted bleach or ammonia solutions, as these may cause discoloration.
- Wipe the surfaces with the appropriate wipes or cloths and approved cleaning products and allow them to dry.
- For additional cleaning methods, recommended cleaning and disinfectant solutions, please visit <https://www.elotouch.com/support/technical-support/cleaning>



Operating time and Panel Image Sticking

*Notice that this product's maximum continuous operating time is 20/7, please pay attention to the following instructions.

- What is Image Sticking? What Causes Image Sticking

Image Persistence, image burn-in, and image sticking are terms used to describe LCD image retention. LCD image retention occurs when a fixed pattern is displayed over a prolonged period. The fixed pattern might cause a parasitic capacitance to build up within the LCD component, which inhibits the liquid crystal molecules from returning to their normal relaxed state.

All LCDs/CRTs and color plasma displays are susceptible to image retention, at varying degrees. Phosphor based display devices, such as CRTs and color plasma displays are most susceptible, and image retention on phosphor-based devices is often irreversible. Transmissive devices, such as LCDs are less susceptible, and in most cases LCD image retention can be reversed.

The rate of image sticking depends on the image pattern, duration of fixed image, the temperature, and production variations. Likewise, the rate of diffusion of the image sticking (recovery time) also depends on these factors.

- What Can Be Done about It

The best way to avoid image bum-in is to limit the amount of static content on the display. Image sticking may be avoided by turning the display off periodically for a period between 2 to 4 hours.

To reduce the possibility of image retention, we recommend:

- Displaying alternating black/white images for 2 to 4 hours

- Using a screen saver when the touchscreen is not in use

Image retention caused by static (non-moving) images displayed for lengthy periods (image burn-in) is not covered under Elo warranty



Section 6: Regulatory Information

Electrical Safety Information

Compliance is required with respect to the voltage, frequency, and current requirements indicated on the manufacturer's label. Connection to a different power source than those specified herein will likely result in improper operation, damage to the equipment, or poses a fire hazard if the limitations are not followed.

There are no operator serviceable parts inside this equipment. There are hazardous voltages generated by this equipment which constitute a safety hazard. Service should be provided only by a qualified service technician.

Contact a qualified electrician or the manufacturer if there are questions about the installation prior to connecting the equipment to mains power.

Emissions and Immunity Information

Notice to Users in the United States: This device complies with part 15 of the FCC Rules. Operation is subject to the following two conditions: (1) This device may not cause harmful interference, and (2) this device must accept any interference received, including interference that may cause undesired operation of the device.

Changes or modifications not expressly approved by the party responsible for compliance could void the user 's authority to operate the equipment.

NOTE: This equipment has been tested and found to comply with the limits of Class A for all model digital devices, pursuant to part 15 of the FCC Rules. These limits are designed to provide reasonable protection against harmful interference in a residential installation. This equipment generates, uses, and can radiate radio frequency energy and, if not installed and used in accordance with the instructions, may cause harmful interference to radio communications. However, there is no guarantee that interference will not occur in a particular installation. If this equipment does cause harmful interference to the radio or television reception, which can be determined by turning the equipment off and on, the user is encouraged to try to correct the interference by one or more of the following measures:

- Reorient or relocate the receiving antenna.
- Increase the separation between the equipment and receiver.
- Connect the equipment into an outlet on a circuit different from that to which the receiver is connected.
- Consult the dealer or an experienced radio/TV technician for help.

This equipment should be installed and operated to ensure a minimum of 20 cm space for any person.



Notice to Users in Canada for IC compliance: This equipment complies with the Class A for radio noise emissions from digital apparatus as established by the Radio Interference Regulations of Industrial Canada.

CAN ICES-003(A) / NMB-003(A)

Devices contains license-exempt transmitter(s)/receiver(s) that comply with Innovation, Science and Economic Development Canada's license-exempt RSS(s). Operation is subject to the following two conditions:

- (1) Those devices may not cause interference.
- (2) Those devices must accept any interference, including interference that may cause undesired operation of the device.

L'émetteur/récepteur exempt de licence contenu dans le présent appareil est conforme aux CNR d'Innovation, Sciences et Développement économique Canada applicables aux appareils radio exempts de licence. L'exploitation est autorisée aux deux conditions suivantes :

- (1) L'appareil ne doit pas produire de brouillage;
- (2) L'appareil doit accepter tout brouillage radioélectrique subi, même si le brouillage est susceptible d'en compromettre le fonctionnement.

Operation of transmitters in the 5.925-7.125 GHz band is prohibited for control of or communications with unmanned aircraft systems.

Notice to Users in the European Union: Use only the provided power cords and interconnecting cables provided with the equipment. The substitution of provided cords and cabling may compromise electrical safety or CE Mark Certification for emissions or immunity as required by the following standards:

This Information Technology Equipment (ITE) is required to have a CE Mark on the Manufacturer's label which means that the equipment has been tested to the following Directives and Standards: This equipment has been tested to the requirements for the CE Mark as required by EMC Directive 2014/30/ EU as indicated in European Standard EN 55032 Class A and the Low Voltage Directive 2014/35/EU as indicated in European Standard EN 62368-1.

General Information to all Users:

This equipment generates, uses, and can radiate radio frequency energy. If not installed and used according to this manual the equipment may cause interference with radio and television communications. There is, however, no guarantee that interference will not occur in any particular installation due to site-specific factors.

1. In order to meet emission and immunity requirements, the user must observe the following:
 - a. Use only the I/O cables provided to connect this digital device with any computer.
 - b. To ensure compliance, use only the provided manufacturer's approved line cord.
 - c. The user is cautioned that changes or modifications to the equipment not expressly approved by the party responsible for compliance could avoid the user's authority to operate the equipment.



2. If this equipment appears to cause interference with radio or television reception, or any other device:
 - a. Verify as an emission source by turning the equipment off and on. If you determine that this equipment is causing the interference, try to correct the interference by using one or more of the following measures:
 - i. Move the digital device away from the affected receiver.
 - ii. Reposition (turn) the digital device with respect to the affected receiver.
 - iii. Reorient the affected receiver's antenna.
 - iv. Plug the digital device into a different AC outlet so the digital device and the receiver are on different branch circuits.
 - v. Disconnect and remove any I/O cables that the digital device does not use. (Unterminated I/O cables are a potential source of high RF emission levels.)
 - vi. Plug the digital device into only a grounded outlet receptacle. Do not use AC adapter plugs. (Removing or cutting the line cord ground may increase RF emission levels and may also present a lethal shock hazard to the user.)

If you need additional help, consult your dealer, manufacturer, or an experienced radio or television technician.

Radio Equipment Directive

Elo hereby declares that the radio equipment type, Elo Pay 15" "Tap-to-Pay", is in compliance with Directive 2014/53/EU. The full text of the EU Declaration of Conformity is available at the following internet address: www.elotouch.com

This device is designed and intended for indoor use only.

	AT	BE	BG	HR	CY	CZ	DK
	EE	FI	FR	DE	EL	HU	IE
	IT	LV	LT	LU	MT	NL	PL
	PT	RO	SK	SI	ES	SE	UK
This device is restricted to indoor use							

Operation frequency and radio-frequency power are listed as below:

- o WLAN 802.11b/g/n/ax 2400MHz-2483.5MHz \leq 20 dBm
WLAN 802.11a/n/ac/ax 5150MHz-5725MHz $<$ 23 dBm
WLAN 802.11a/n/ac/ax 5725MHz-5825MHz $<$ 13.98 dBm
WLAN 802.11ax 59450MHz-6425MHz $<$ 23 dBm
- o Bluetooth BREDRLE 2400MHz-2483.5MHz \leq 20 dBm

ECC/DEC/ (04)08:

The use of the frequency band 5 150-5 350 MHz is restricted to indoor operation because of the protection requirements of satellite services

EC R&TTE Directive EU Directive 2014/53/EU of the European Parliament and of the Council of 16 April 2014 on the harmonization of the laws of the Member States relating to making available on the market of radio equipment and repealing Directive 1999/5/EC Text with EEA relevance.



Identification marks the relevant technical documentation is held at: Elo Touch Solutions, Inc. 670 N. McCarthy Boulevard Suite 100 Milpitas, CA 95035 USA

USA FCC ID: RBWESYQC5PAY
Canada IC ID: 10757B-ESYQC5PAY
Canada IC HVIN: ESY1511EPAY

Agency Certifications

The following certifications and marks have been issued or declared for this peripheral:

- UL, FCC (US) – Class A
- cUL, IC (Canada)
- CB (International Safety)
- CE (Europe) – Class A
- VCCI (Japan)
- RCM (Australia)
- China RoHS

Waste Electrical & Electronic Equipment Directive (WEEE)



This product should not be disposed of with household waste. It should be deposited at a facility that enables recovery and recycling. Elo has put in place recycling arrangements in certain parts of the world. For information on how you can access these arrangements, please visit www.elotouch.com/e-waste-recycling-program/.



Replace the battery with same type only. Improper replacement of battery may cause in risk of burns, fire, and explosions. Dispose the battery according to local regulations. Risk of fire and burns if properly handled. Do not open and crush, heat above 60° C / 140° F or incinerate. If there is a serious swelling of the battery, do not continue using.

Energy Star

Elo Pay 15” “Tap-to-Pay” devices can meet Energy Star 9.0 requirements.



Energy Star is a program run by the U.S. Environmental Protection Agency (EPA) and U.S. Department of Energy (DOE) that promotes energy efficiency.

This product qualifies for ENERGY STAR in the “factory default” settings and this is the setting in which power savings will be achieved. Changing the factory default picture settings or enabling other features will increase power consumption that could exceed the limits necessary to qualify for ENERGY STAR rating.

For more information on the ENERGY STAR program, refer to energystar.gov

Child Safety Warning

This Product is not intent for use by children. This product is not suitable for use in locations where children are likely to be present.

Section 7: Warranty Information

For warranty information, go to <http://support.elotouch.com/warranty/>

www.elotouch.com

Visit our website for the latest

- Product Information
- Specifications
- Upcoming Events
- Press Releases
- Software Drivers

Google, Android, Google Play and YouTube are trademarks of Google LLC.

To find out more about our extensive range of Elo touch solutions, go to www.elotouch.com, or call the office nearest you.

North America

Tel +1 408 597 8000
Fax +1 408 597 8001
elosales.na@elotouch.com

Europe

Tel +32 (0)16 70 45 00
Fax +32 (0)16 70 45 49
elosales@elotouch.com

Asia-Pacific

Tel +86 (21) 3329 1385
Fax +86 (21) 3329 1400
www.elotouch.com.cn

Latin America

Tel +52 55 2281-6958
elosales.latam@elotouch.com

