

REFRIGERATOR DOOR REVERSAL KIT

Models: WTB2300WC, WTB2300PC, WTB2500WC, WTB2500PC, WTB2800WC, WTB2800PC, WTB3400WC, WTB3400PC, WTB3700WC, WTB3700PC

KIT CONTENTS

	DESCRIPTION	QTY
	Cover top cabinet wh GR	1
	Cover top cabinet wh WHT	1
	Hinge top cover left GR	1
	Hinge top cover left WHT	1
	Hinge top left	1
	Hinge centre left	1
	Hinge bottom base left	1
	Door auto closer LH	2

NOTE: Keep kit parts separate from other parts as you disassemble them to avoid mix-ups.

TOOLS YOU WILL NEED (not supplied)

	Phillips head screwdriver
	8mm (5/16") hex head socket

WARNING

Westinghouse takes no responsibility for incorrectly assembled doors leading to injury or malfunction.

CAUTION

Refrigerator must stand for 30 minutes prior to connecting to power supply to ensure system functions correctly.

IMPORTANT

All hinge screws require tightening to a torque setting of 5-10Nm.

FRIDGE DESCRIPTION

Top view of right hand hinge cabinet

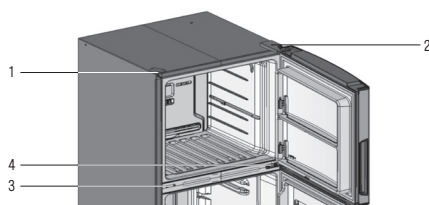

Bottom view of right hand hinge cabinet

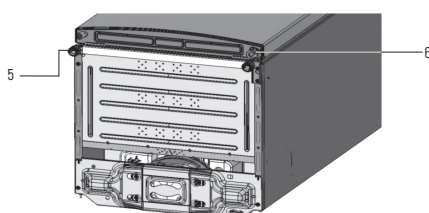

- | | |
|---|---------------------------------|
| 1 Cover top cabinet WH | 4 Hinge centre right and screws |
| 2 Hinge top right and hinge top cover right | 5 Adjustable foot |
| 3 Cover screw mullion WH and screws | 6 Hinge bottom assy right |

INSTRUCTIONS

1. Ensure refrigerator is empty of all loose items and unplugged from power source.

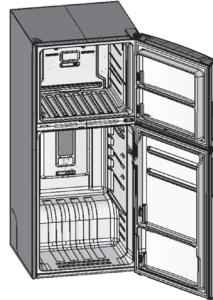

2. Store power cord next to motor to prevent damage. Check for water in drain pan and remove any water with a cloth or sponge if necessary.

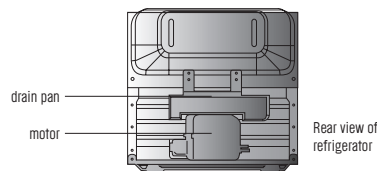

3. Lay the refrigerator on its back.

WARNING
Your refrigerator is heavy- you may need assistance.

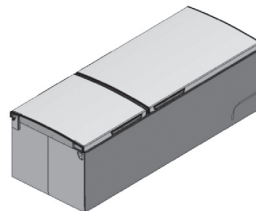

4. Remove the hinge cover with a soft plastic lever.

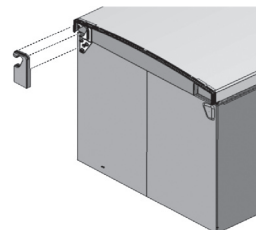

5. Remove the LH cap with a soft plastic lever.

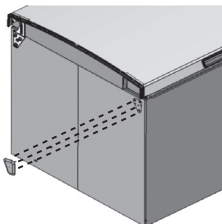

6. Unscrew 3 x 8mm top hinge screws and remove RH top hinge. Do not discard screws.

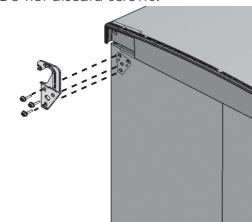

7. Remove freezer door by opening 45° and gently slide off hinge. Set door aside to prevent damage.

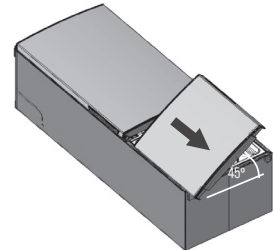

8. Unscrew 2 centre hinge screws. Remove the Covers and 2 Phillips screws underneath the covers. Do not discard screws and covers.

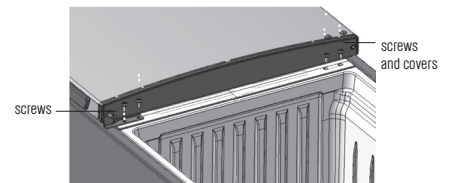

9. Remove RH centre hinge by lifting the door slightly and sliding hinge out of the door.

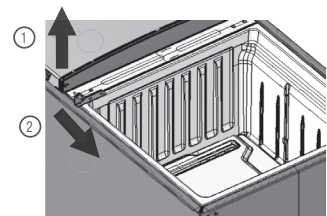

10. Remove food door by opening 45° and gently slide off hinge. Set door aside to prevent damage.

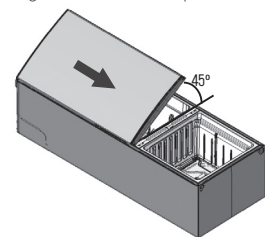

11. Remove the Pocket Handle Cover and Cover door from the Fzr door and assemble them on the other side. Remove the RH Door auto closer and replace with LH Door auto closer (kit Content) on the other side. Repeat the same steps with Food door.

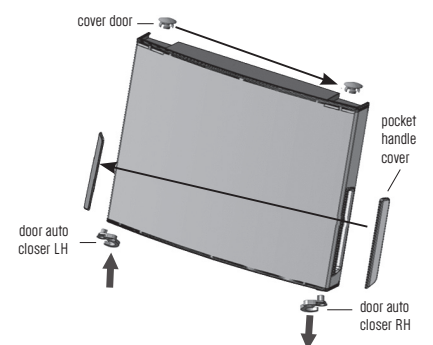

Follow Step number 12 to 16 for model WTB2300 and WTB2500 where fitted with Kick Plate). For other models without Kick Plate please skip to Step number 17 and onwards.

12. Unscrew the four screws indicated below to remove the side kickplates.

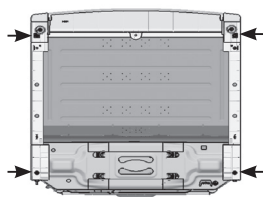

13. Unscrew the bottom hinge screw shown, pull the hinge away from cabinet then up to remove.

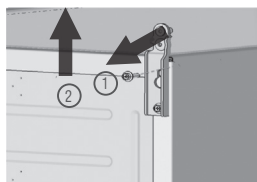

14. Place the bottom hinge LH (Kit content) onto the cabinet, placing it down then towards cabinet to install. Replace the screw.

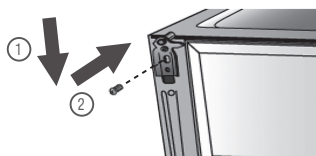

15. Remove the spacer from the kickplate and clip to the other side.

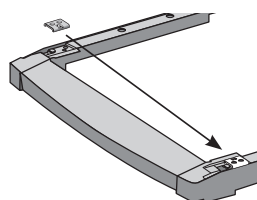

16. Assemble the kickplate to the refrigerator using the four screws.

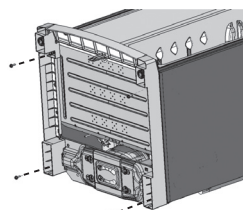

Skip Steps 17 to 20 and follow from Step 21 & onwards.

17. Unscrew the hinge foot using phillips head screwdriver and unscrew foot on opposite side. Do not discard.

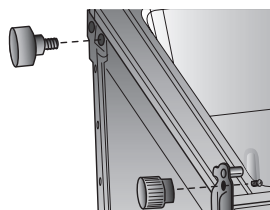

18. Unscrew the bottom hinge screw shown, pull the hinge away from cabinet then up to remove.

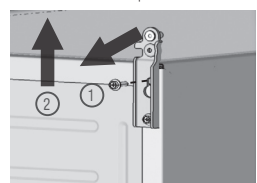

19. Place the bottom hinge LH (kit contents) onto the cabinet, placing it down then towards cabinet to install. Replace the screw.

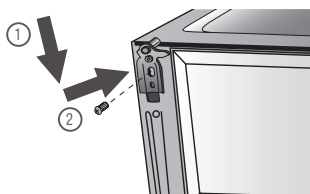

20. Replace the hinge foot onto the LH bottom hinge and tighten with screw.

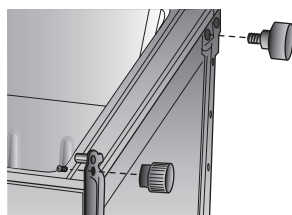

21. Replace the food door by holding at 45° and gently slide onto the bottom hinge and closing the door.

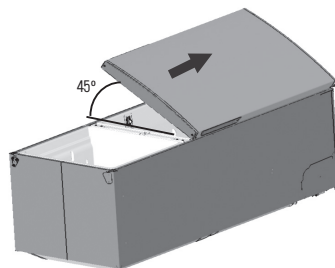

22. Replace LH centre hinge (Kit Content) by lifting the door slightly and sliding hinge into the door and placing the door down again.



23. Insert 2x8mm screws from existing center hinge into the LH center hinge, tighten the screws until the bracket is secured. Assemble the 2 Phillips head screws and covers on other side as shown.

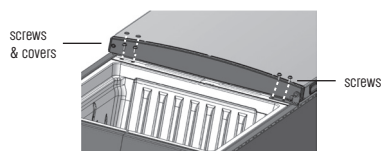

24. Replace the freezer door by holding at 45° and gently slide onto the centre hinge and closing the door.

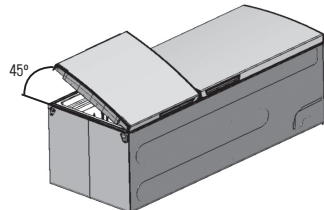

25. Slide the LH top hinge (kit contents) into the door, loosely screw the 3 x 8mm screws from the existing top hinge in the cabinet.

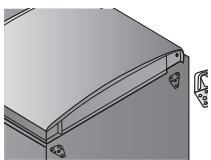

26. Ensure that the edges of the doors are parallel with the sides of the cabinet.

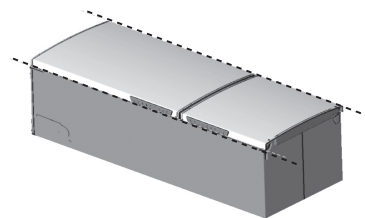

27. Ensure that the food door and the freezer door have a parallel gap.

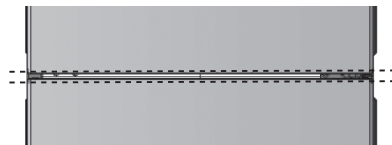

28. Fully tighten the LH top hinge to the cabinet until the hinge is secure.

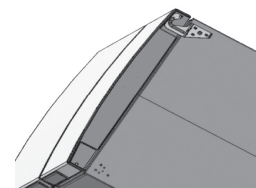

29. Clip the LH hinge cover (kit contents) over LH top hinge.

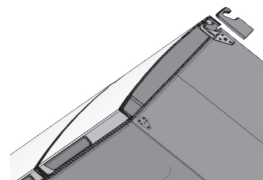

30. Insert the RH top hinge hole cap (kit contents) in the cabinet as shown.

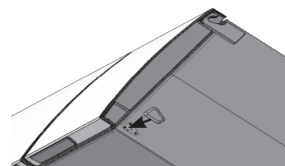

31. Stand the refrigerator upright.



WARNING
Your refrigerator is heavy – you may need assistance.



33. Level the cabinet by adjusting the foot.



** Recommended to apply a small amount of silicone grease (Molykote EM-50L or equivalent – not provided with kit) on all pivoting pin of left hand hinges for lubrication **

For further information on all Westinghouse appliances, or to obtain detailed dimension and installation information, call into your Retailer, phone or email our Customer Care team or visit our website:

AUSTRALIA
phone: 1300 363 640
fax: 1800 350 067
email: customercare@electrolux.com.au
web: www.westinghouse.com.au

NEW ZEALAND
phone: 09 573 2384
fax: 0800 363 600
email: customercare@electrolux.co.nz
web: www.westinghouse.co.nz

Westinghouse. We are part of the Electrolux family.
Share more of our thinking at www.electrolux.com