

use & care guide

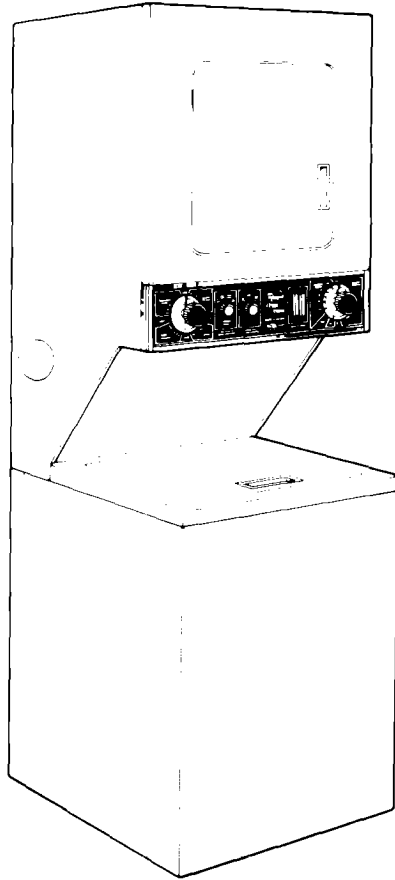

thin
twin

WASHER • DRYER

Model LT4900XM

rowave Ovens. Trash Compactors. Room Air Conditioners. Dehumidifiers. Automatic Washers. Clothes Dryers. Freezers. Refrigerator-Freez

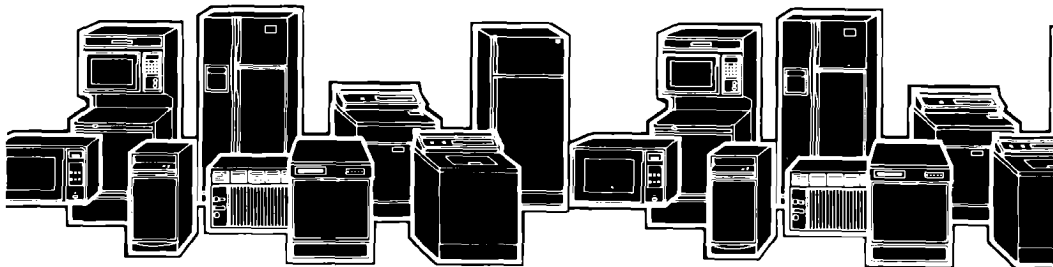

Parts and features

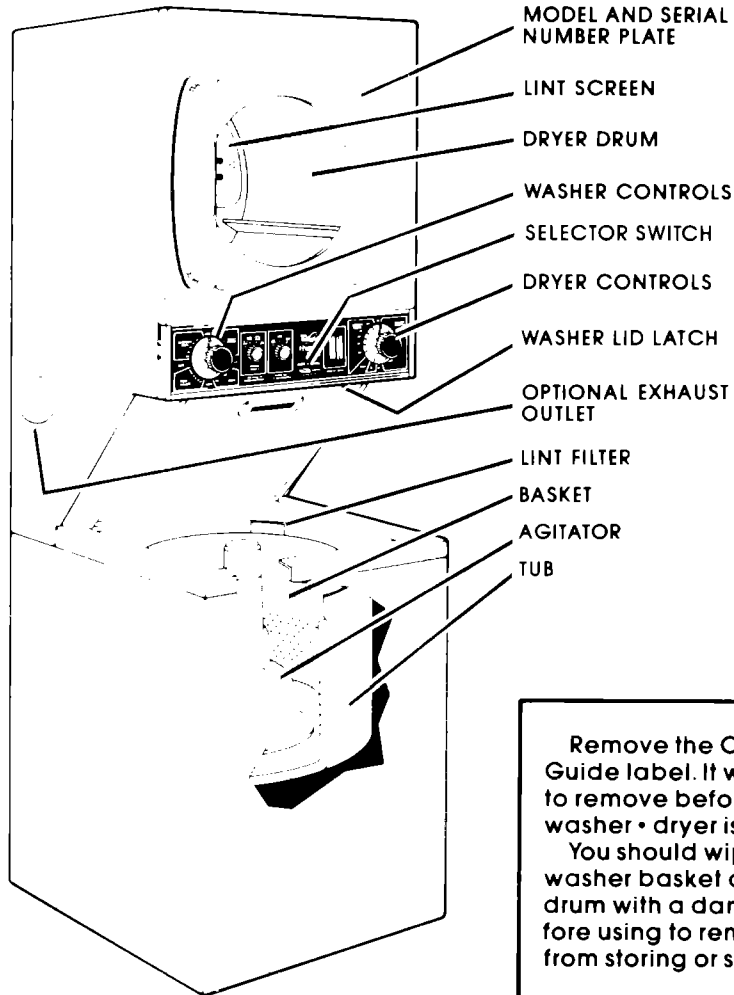

Remove the Consumer Buy Guide label. It will be easier to remove before the washer-dryer is used.

You should wipe out the washer basket and dryer drum with a damp cloth before using to remove dust from storing or shipping.

Copy your Model and Serial Numbers here

When you need service or call with a question, have this information ready:

1. **Complete** Model and Serial Numbers (from the plate located as shown).
2. Purchase date from sales slip

Copy this information in these spaces. Keep this book, your warranty and sales slip together in a handy place. There is no warranty registration to return. Proof-of-purchase is all that is required for in-warranty service.

Complete Model Number

Complete Serial Number

Purchase Date

Service Company and Telephone Number

Contents

Your Responsibilities	3	DRYER	
Installation	3	Starting Your Dryer	11
Operation	3	Selecting a Cycle	12
Safety	4	Lint Screen	13
Before Using		Lint Removal	13
Your Washer•Dryer	5	WASHER•DRYER	
WASHER		Vacation Care	14
Starting Your Washer	6	Winterizing	14
Lid Latch	7	If You Need Service or	
What Happens in Each Cycle	8	Assistance	14
Other Operating Instructions	10	1. Before Calling for	
Lint Filter	10	Assistance	14
		2. If You Need Assistance	15
		3. If You Need Service	15
		4. If You Have a Problem	15

Your responsibilities

Read this "Use and Care Guide" and your "Laundry Guide" carefully for important use and safety information.

You are personally responsible for installation. Have your washer / dryer installed by a qualified installer and make sure that it has been...

1. Installed exactly according to the "Installation Instructions," including...
 - proper electrical supply, outlet and grounding;*
 - proper water supply, plumbing fixtures and drain;*
 - proper dryer exhausting system.*
2. Installed and leveled in a room where...
 - there is adequate ventilation and protection from weather;
 - the floor is strong enough to support the weight;
 - The temperature is above 45°F (7.2°C) because...
 - the dryer will not operate properly at cold temperatures.
 - freezing temperatures can damage the washer.

***Refer to the "Installation Instructions" for complete information.**

You are personally responsible for proper use of your washer / dryer. You must be sure that it is...

1. Used only by those who understand how to operate it properly.
2. Properly maintained and used only for jobs expected of home washers and dryers.

You are personally responsible for the safe use of your washer / dryer.

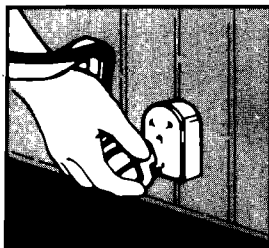

DO NOT try to service this appliance unless it is unplugged or the electrical power has been turned off.

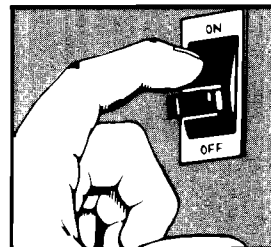



POISON GAS is formed when chlorine bleach is mixed with ammonia or acids such as vinegar or rust remover.

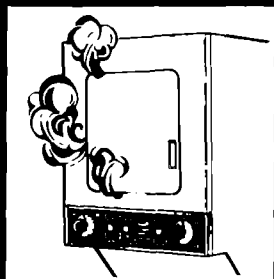

FIRE HAZARD and DAMAGE to some materials can result from:

- drying heat-sensitive fabrics with heat (see page 12).
- operating the dryer with the lint screen loose, damaged or missing.
- allowing lint to build up inside the dryer (see page 13).

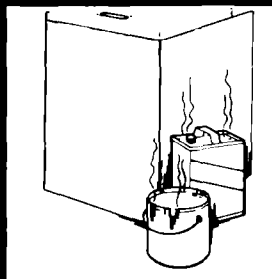

DO NOT use or store gasoline, dry cleaning fluids and other chemicals that give off explosive fumes in or near this appliance. If an item has any of these chemicals on it, make sure it is thoroughly rinsed before adding it to the washer, and washed before adding it to the dryer.

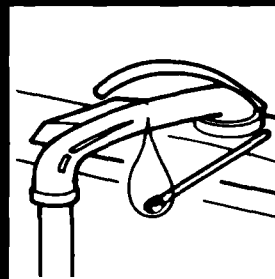

SPECIAL CAUTION: Explosive hydrogen gas can build up in the water heater and hot water pipes. If hot water has not been used for two weeks or more, run hot water from **EVERY** faucet for a few minutes. **DO NOT SMOKE OR USE ANY ELECTRICAL APPLIANCE.**



DO NOT let dust, lint, paper, rags, chemicals, etc., pile up around or under the appliance. **DO NOT** install the appliance against drapes or curtains.

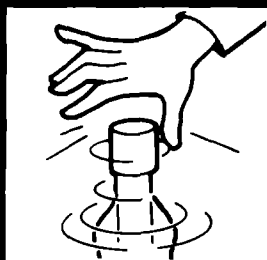

DO NOT add or remove anything while the washer is agitating or spinning. If the washer lid is opened during the spin, the washer will automatically stop in a few seconds.

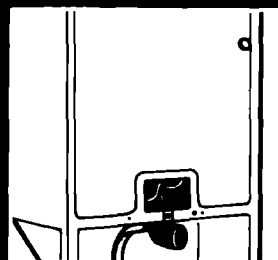

DO NOT operate the appliance if...

- it is not working right,
- it is damaged,
- parts are missing,
- all panels are not in place.

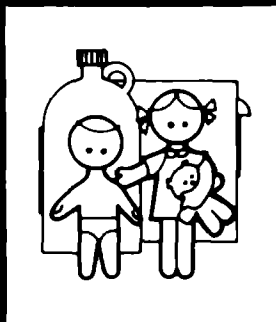

DO NOT let children use or play with this appliance. Cleaning aids, detergents, etc., should be kept out of their reach – in a locked cabinet, if possible.

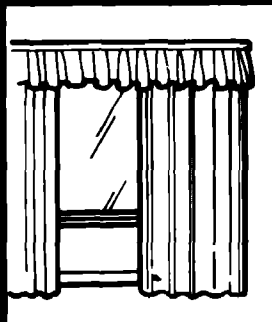

DO NOT machine wash or dry glass fiber materials. Small particles can stick to fabrics washed and dried in following loads and cause skin irritation.

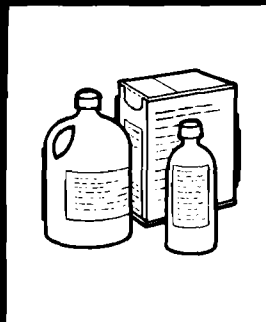

ALWAYS read and follow instructions on packages of detergent and laundry aids – especially warnings and precautions.

Before using your THIN TWIN* washer • dryer

For best washing and drying results, you must take some very important steps before, during and after each load:

1. Prepare and sort each load for washing ("Laundry Guide," pages 4-5).
2. Measure and add detergent or soap to washer ("Laundry Guide," pages 9-10).
3. Load the washer properly ("Laundry Guide," pages 6-7).
4. Select the water temperature, load size and cycle recommended for the fabrics before starting the washer ("Use and Care Guide," pages 6-7).
5. Add other laundry aids to the washer according to instructions ("Laundry Guide," pages 11-13).
6. Properly sort the load for drying ("Laundry Guide," pages 18-19).
7. Select the right drying cycle and time for the fabrics ("Use and Care Guide," page 12).
8. Remove and hang or fold items **immediately** after drying.

Service or performance problems caused by the use of any product not manufactured by Whirlpool Corporation is the responsibility of the manufacturer of that product.

Starting your washer

Before starting your washer, be sure you have measured and added detergent, you have sorted the load properly, and you have used other laundry aids only as recommended in your "Laundry Guide."

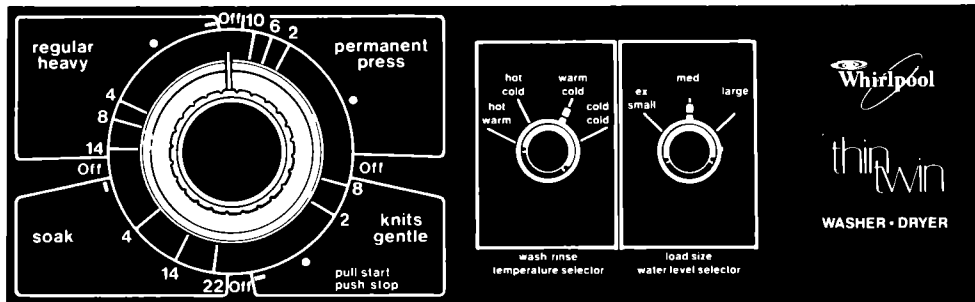

1. Select a LOAD SIZE

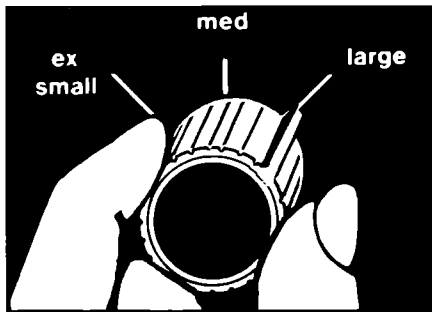

- Turn the LOAD SIZE SELECTOR Knob to a setting that describes the size of the load to be washed. See the "Laundry Guide," page 7, for load size suggestions.

2. Select WATER TEMPERATURES

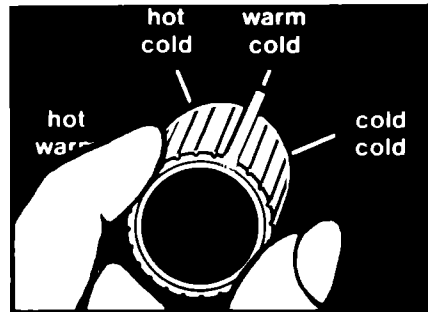

- Turn the TEMPERATURE SELECTOR Knob to a setting with the wash and rinse water temperatures you want for the load.
 - This drawing shows a warm wash and cold rinse.
- For recommended wash temperatures, see page 8 in "Laundry Guide."**

LOAD SIZES AND WATER LEVELS

Use less than a full tub of water when you have less than a full load to wash.

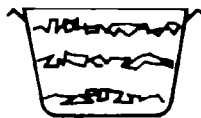

LARGE (11.9 gals - 45* L)*
MEDIUM (9.6 gals - 36.3 L)*
EX-SMALL (7.3 gals - 27.7 L)*

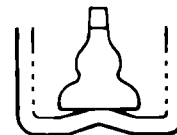

* Approximate fill with load

To hold the washer lid up, lift the lid until it snaps past the latch.

To release the lid, push the lid latch up.

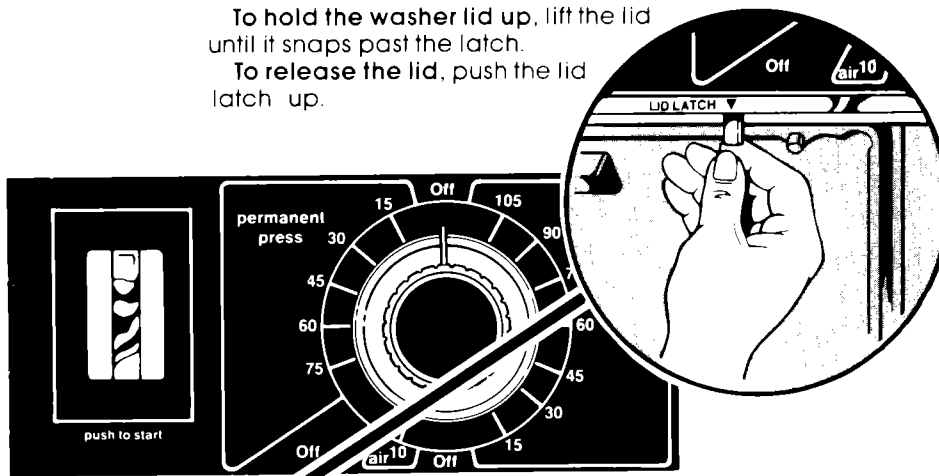

Select CYCLE and WASH TIME;

3. Start the washer

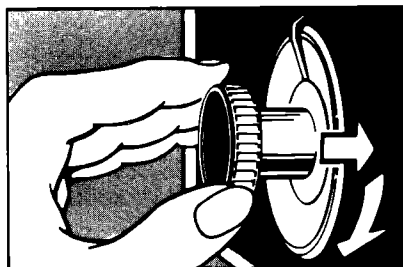

- A.** Push in the Control Knob and turn it to the right. It must be pushed in and turned only to the right (clockwise).

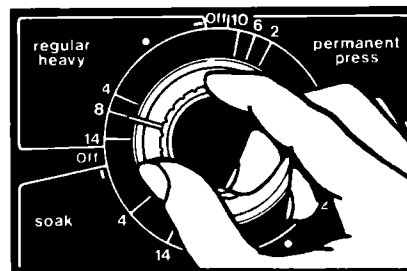

- B.** Stop on a number in the cycle you want. The numbers are minutes of wash time. The drawing shows 8 minutes of agitation in the REGULAR HEAVY Cycle.

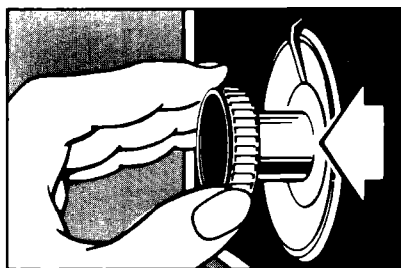

- C.** Start the washer by pulling out the Control Knob. The washer will fill to the level you set with wash water of the selected temperature. After filling, the washer will agitate for the selected number of minutes.

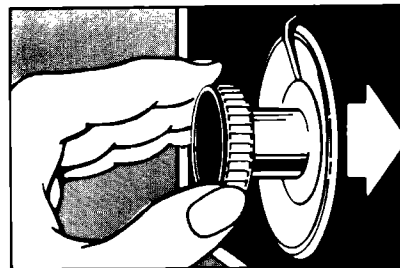

- D.** To stop the washer at any time, push in the Control Knob. To restart the washer, pull out the Control Knob.

To set the controls for a rinse and spin, a drain and spin, or a soak or pre-wash, see page 10.

What happens in each cycle

Each cycle on your washer is designed for a different kind of fabric. Numbers on the dial in each cycle are the minutes of WASH time. Agitation and spin speeds are different in each cycle. When the Cycle Control Knob is set to a number and pulled out, the

REGULAR HEAVY Cycle

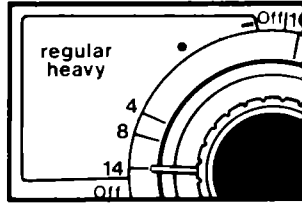

Use for sturdy white and colorfast cottons, and for heavy work clothes. High agitation and spin speeds are designed to help remove heavy soils and spin water from heavy cotton fabrics.

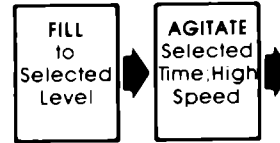

PERMANENT PRESS Cycle

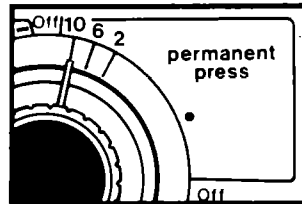

Use for permanent press fabrics. Cooling of the wash water before the spin helps prevent the setting of wrinkles.

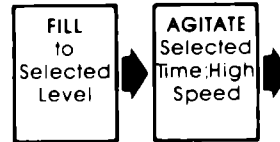

The washer pauses for about 1 1/2 minutes after partial drain.

KNITS GENTLE Cycle

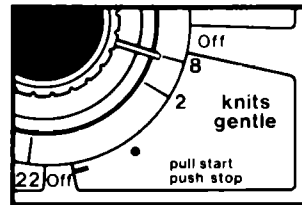

Low agitation and spin speeds and shorter wash time make this cycle the one to use for delicate items and washable synthetic knits. Wash nylon hose or panty hose in a net laundry bag.

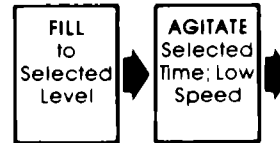

SOAK Cycle

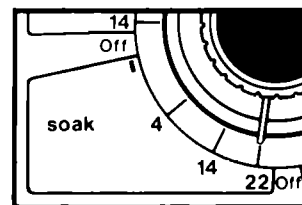

This cycle does not rinse. It soaks, agitates, spins out the water and stops. Use it to pre-wash stained, yellowed, grey or heavily soiled laundry with a detergent or pre-soak product.

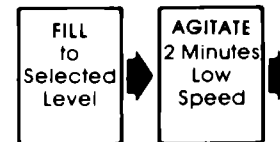

washer fills before agitation and timing start. After agitation starts, the knob turns clockwise until the pointer reaches off and the cycle ends.

You may hear the sound of water spraying during the spin parts of some cycles. In some cycles, cold water is sprayed on the spinning load to help with the rinsing.

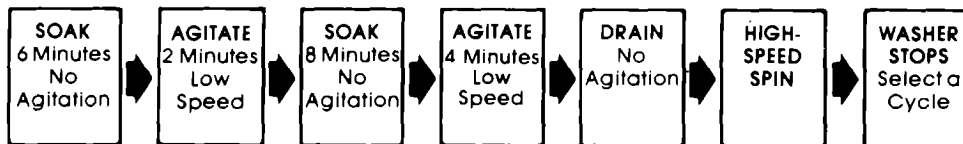
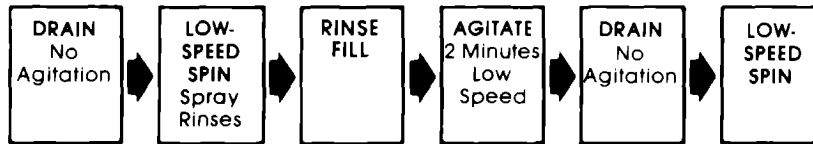
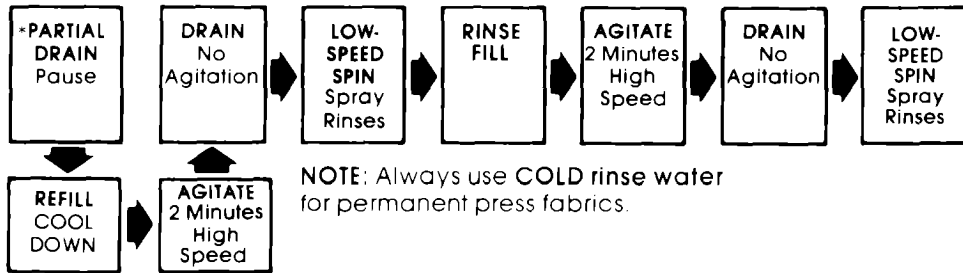
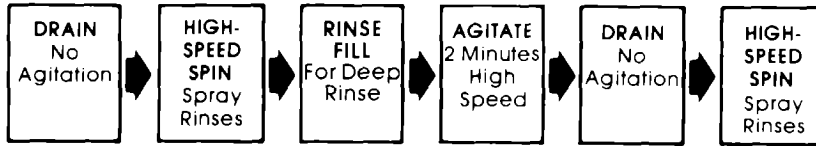

Special care is required for the handling of a load when soaking or pre-washing.
See your "Laundry Guide" for proper use of this cycle.

WHAT HAPPENS IN EACH CYCLE



Other operating instructions

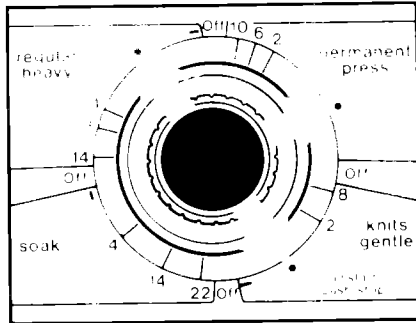

For a rinse and spin

- Push Control Knob in.
- Turn clockwise to any dot on the dial. See above drawing.
- Pull Control Knob out.
- The washer will fill with **rinse water**, agitate 2 minutes, drain and spin.

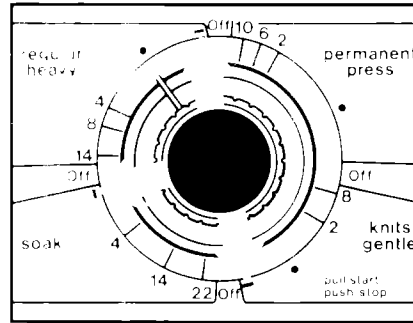

For a drain and spin

- Push Control Knob in.
- Turn clockwise to the **bar** just before OFF in any cycle. See above drawing.
- Pull Control Knob out.
- The washer will drain and spin.

For agitation and spin speeds in each cycle, see pages 8 and 9.

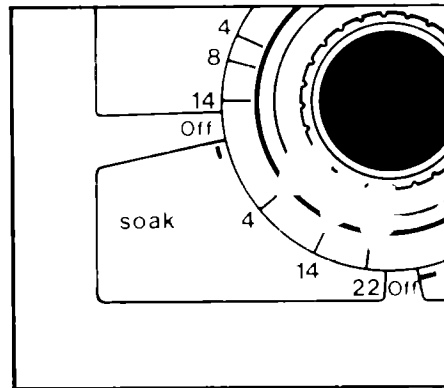

For a soak or pre-wash

- Use enough detergent or pre-soak product for a single load.
- Push Cycle Control Knob in.
- Turn clockwise to point at a number in the SOAK Cycle.
- Pull Control Knob out.
- When the cycle is over, add detergent for the next selected wash cycle. **(IMPORTANT: See page 7 in "Laundry Guide.")**
- Set the washer and start the next selected wash cycle.

To start the soak or pre-wash with agitation, the Cycle Control Knob must point to a number in the SOAK Cycle.

Lint filter

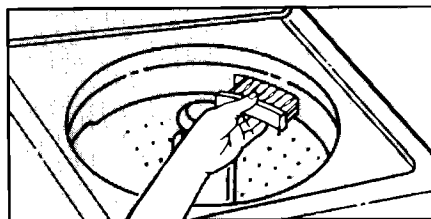

Clean the lint filter after each load. Press the release and pull it straight out. Instructions for cleaning are printed on the bottom.

Starting your dryer

Before starting your dryer, be sure the load is properly sorted ("Laundry Guide," page 18) and the **door is closed tightly**.

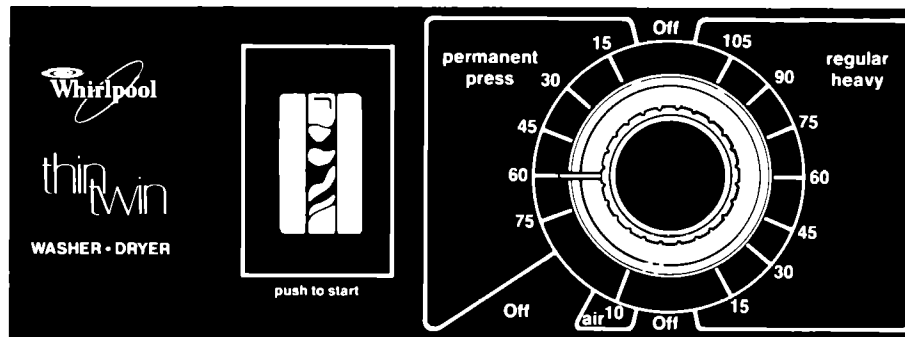

1. Select CYCLE and TIME

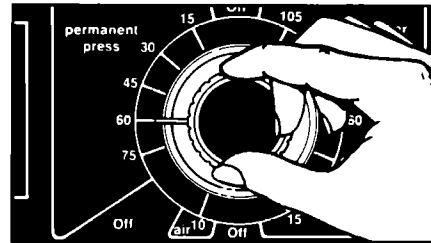

Turn the Control Knob either way to point to the time setting you want in the cycle you want.

2. Push the START Button

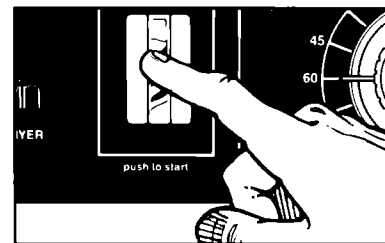

The dryer will start tumbling when you push the START Button.

3. To stop and restart the dryer

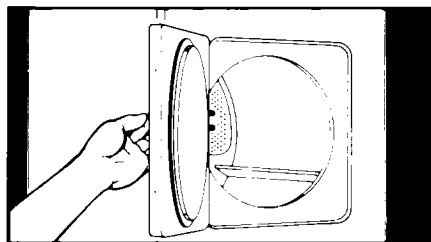

To stop, open the door (or turn the Control Knob to OFF).
To restart, close the door and push START.

4. To change the setting

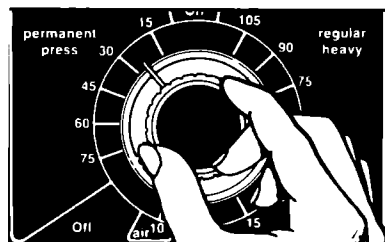

The setting can be changed at any time by turning the Control Knob to a new setting.

OTHER OPERATING INSTRUCTIONS • LINT FILTER • STARTING YOUR DRYER

Selecting a cycle

Dryer cycles are designed for the proper drying of different kinds of fabrics. This dryer has 3 cycles:

REGULAR HEAVY – The heat is off during the last 5 *minutes* of tumbling. The load is cooled down for more comfortable handling.

PERMANENT PRESS – The heat is off during the last 10 *minutes* of tumbling to help keep wrinkles from setting in. Clothing wrinkled from packing

in suitcases or closets can be smoothed out by tumbling them in this cycle for about 20 minutes.

AIR – No heat. This cycle is useful when drying heat-sensitive items or when fluffing pillows and bedding or dusting sheers and curtains.

TYPE OF LOAD	SUGGESTED CYCLE
COTTONS	
HEAVY – Bedspreads, mattress pads, quilts	REGULAR HEAVY
MEDIUM AND LIGHTWEIGHT – Shirts, dresses, sheets, diapers, towels, work clothes	REGULAR HEAVY
PERMANENT PRESS	
HEAVY – Work clothes, jackets, raincoats, etc.	PERMANENT PRESS
MEDIUMWEIGHT – Shirts, uniforms, dresses, slacks, etc.	PERMANENT PRESS
KNITS	
HEAVYWEIGHT – COTTONS, RAYONS, BLENDS – T-Shirts, slacks, polo shirts, etc.	PERMANENT PRESS
LIGHTWEIGHT – SYNTHETIC FIBERS (polyester, acrylic, etc.) AND BLENDS – Lingerie, blouses, dresses, etc.	PERMANENT PRESS
DELICATELY CONSTRUCTED FABRICS –	
Sheer Curtains (2 or 3 panels)	PERMANENT PRESS
RUBBER, PLASTIC, HEAT SENSITIVE FABRICS	
Pillows, bras, etc.	AIR
Plastic shower curtains, tablecloths	AIR
Rubber backed rugs	AIR
Olefin, polypropylene, sheer nylon	AIR
Drying these and other materials with heat can damage them or be a FIRE HAZARD.	

Drying times

Drying times depend mostly on the size of the load and the fabrics in it. For other things that affect drying time, see page 19 in your "Laundry Guide."

Mixed loads

When drying a load with different kinds and weights of fabrics, use the cycle suggested for the lightest fabrics. When the dryer stops, remove dry items and reset the control.

Lint screen

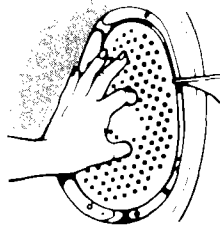

Pull straight out.

The lint screen is inside the dryer drum, on the back wall. **Clean it before each load.** A screen blocked by lint can increase drying time.

1. Use the finger holes to pull the lint screen straight out.
2. Lightly squeeze the body, as shown, while pulling the cover off.

3. Roll lint off the screen with your fingers. **DO NOT rinse or wash the screen.** Wet lint is hard to remove.

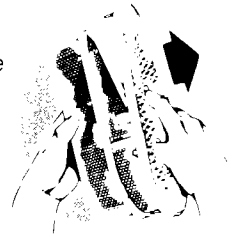

Squeeze body; pull cover off.

4. Replace the cover on the body of the lint screen.
5. Push the lint screen straight back in until it clicks into place.



CAUTION: RUNNING THE DRYER WITH THE LINT SCREEN LOOSE, DAMAGED OR MISSING CAN CAUSE OVERHEATING, DAMAGE TO FABRICS AND DRYER PARTS, OR CREATE A FIRE HAZARD.

Lint removal

Lint can gather inside the dryer and create a fire hazard. **This lint should be removed every 2 to 3 years, or more often, depending on dryer usage.** A qualified service person is recommended for this job.

- Unplug power supply cord.
- Make sure dryer is cool.
- Metal edges may be sharp.

1. Remove back panel from dryer.
2. Avoid touching thermostats, wires, terminals and heater box.
3. Remove lint from shaded area – see art – with a soft brush or vacuum cleaner.
4. Replace back panel. Reconnect, exhaust duct, etc. Level the washer/dryer.

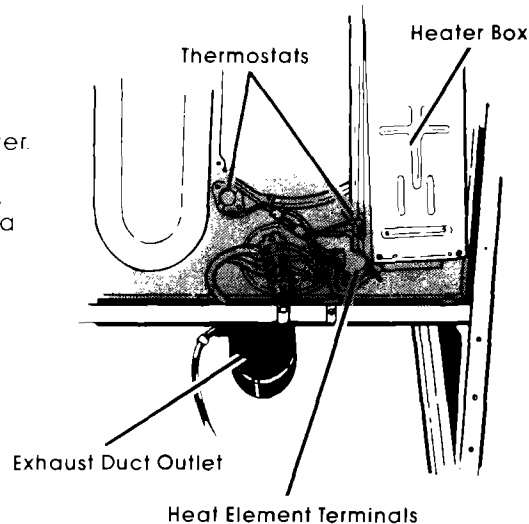

Vacation care

1. Turn off both water faucets to take pressure off inlet valves and hoses.
2. Unplug power supply cord or turn off electrical power supply.
3. Clean lint screen and lint filter.

Winterizing

Install and store your washer / dryer where it won't freeze. Because some water stays in the washer, freezing can damage it. If your washer / dryer is stored **or moved** during freezing weather, winterize it.

1. Shut off both water faucets. Disconnect and drain water inlet hoses.
 2. Put a quart of auto-mobile-type anti-freeze in the basket.
 3. Run washer on a drain and spin setting (see page 10) for about 30 seconds to mix antifreeze and water.
- To use washer again:**
1. Flush water pipes and hoses.
 2. Reconnect water inlet hoses.
 3. Turn on both water faucets.
 4. To clean out anti-freeze, run washer through a complete cycle with a cup of detergent.

If you need service or assistance, we suggest you follow these four steps:

1. Before calling for assistance...

Performance problems often result from little things you can find and fix yourself without tools of any kind.

IF YOUR WASHER DOES NOT FILL:

- Is the power supply cord plugged in?
- Are both water faucets open?
- Are fuses blown or circuit-breaker tripped?
- Are the water supply hoses kinked?
- Is the Cycle Control Knob set and pulled out?

IF YOUR WASHER DOES NOT SPIN:

- Is the lid closed?
- Is the power supply cord plugged in?
- Are fuses blown or a circuit-breaker tripped?

IF WASHER DRAINS AT THE WRONG TIME:

- The drain hose should be at least 28 inches above the floor and secured.
- The drain hose should not fit tightly in the drain pipe.

MAKE SURE THE DRAIN HOSE IS HIGHER THAN THE WATER LEVEL IN THE WASHER. IF IT ISN'T...

- The washer may seem to be draining during wash and rinse cycles.
- Water can siphon out. (See "Installation Instructions!")

IF YOUR WASHER STOPS DURING THE PERMANENT PRESS CYCLE:

- Remember, the washer will stop for about 1½ minutes after the partial drain during the cool-down period in this cycle.

DRYER DOESN'T RUN OR DOESN'T HEAT:

- Is it plugged in?
- Is the circuit-breaker tripped or one or both of the fuses blown?
- Did you push START?
- Is the door closed?
- The AIR setting is without heat.
- The last minutes of heat settings are without heat. See page 12.

DRYING TIME SEEMS LONG:

- Is the lint screen clean?
- Is the room cold?
- Check your "Laundry Guide," page 19.

2. If you need assistance*...

Call the Whirlpool COOL-LINE® service assistance telephone number. Dial free from:

Continental U.S. ... (800) 253-1304
Michigan (800) 632-2243
Alaska & Hawaii .. (800) 253-1121

and talk with one of our trained Consultants. The Consultant can instruct you in how to obtain satisfactory operation from your appliance or, if service is necessary, recommend a qualified service company in your area.

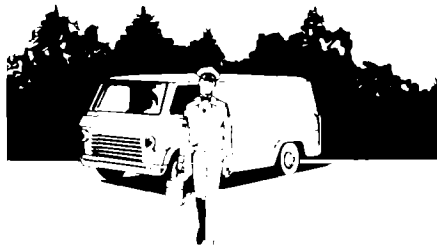

3. If you need service*...

Whirlpool has a nationwide network of franchised TECH-CARE® service companies. TECH-CARE service technicians are trained to fulfill the product warranty and provide after-warranty service, anywhere in the United States. To locate TECH-CARE service in your area, call



our COOL-LINE service assistance telephone number (see Step 2) or look in your telephone directory Yellow Pages under:

APPLIANCES—HOUSEHOLD—MAJOR—SERVICE & REPAIR

WHIRLPOOL APPLIANCES
FRANCHISED TECH-CARE SERVICE

*YZ SERVICE CO
123 Maple

SERVICE COMPANIES

999-9999

OR

ELECTRICAL APPLIANCES—MAJOR—REPAIRING & PARTS

WHIRLPOOL APPLIANCES
FRANCHISED TECH-CARE SERVICE

*YZ SERVICE CO
123 Maple

SERVICE COMPANIES

999-9999

OR

WASHING MACHINES, DRYERS & IRONERS—SERVICING

WHIRLPOOL APPLIANCES
FRANCHISED TECH-CARE SERVICE

*YZ SERVICE CO
123 Maple

SERVICE COMPANIES

999-9999



FSP is a registered trademark of Whirlpool Corporation for quality parts. Look for this symbol of quality whenever you need a replacement part for your Whirlpool appliance. FSP replacement parts

will fit right and work right, because they are made to the same exacting specifications used to build every new Whirlpool appliance.

4. If you have a problem*...

Call our COOL-LINE service assistance telephone number (see Step 2) and talk with one of our Consultants, or if you prefer, write to:

Mr. Guy Turner, Vice President
Whirlpool Corporation
Administrative Center
2000 US-33 North
Benton Harbor, MI 49022

If you must call or write, please provide: model number, serial number, date of purchase, and a complete description of the problem. This information is needed in order to better respond to your request for assistance.

VACATION CARE • WINTERIZING • IF YOU NEED SERVICE

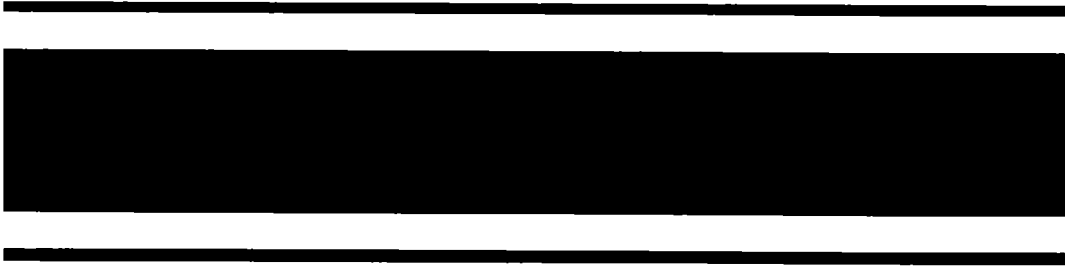

Making your world a little easier.

Part No. 693010

Printed in U.S.A.



Automatic Washers, Clothes Dryers, Freezers, Refrigerator-Freezers, Ice Makers, Dishwashers, Built-In Ovens and Surface Units, Ranges, Micro

