



Washer

User manual

WA52M8650A*



SAMSUNG



Contents

Safety information	4
What you need to know about the safety instructions	4
Important safety symbols	4
Important safety precautions	5
Installation	13
Unpacking your washer	13
Overview of your washer	14
Basic location requirements	16
Important note to installer	20
Step-by-step installation	20
Operating instructions	28
Loading your washer	28
Getting started	29
Washing a load of laundry	30
Control panel	30
Options	33
Washing clothes using the option button	37
ATC (Auto Temperature Control)	38
The basics	39
Detergent use	41
Features	42
Maintaining your washer	46
Cleaning the exterior	46
Cleaning the interior	46
Storing your washer	46
Preserving the top cover and the front frame	47
Cleaning mesh filter	47
Cleaning the dispensers	47
Self Clean	49
Troubleshooting	50
Checkpoints	50
Information codes	54



Specifications

57

Fabric care chart	57
Helping the environment	59
Declaration of conformity	59
Specification sheet	60
Cycle chart	61

Contents

Safety information

Congratulations on your new Samsung washer. This manual contains important information on the installation, use and care of your appliance. Please take some time to read this manual to take full advantage of your washer's many benefits and features.

What you need to know about the safety instructions

Please read this manual thoroughly to ensure that you know how to safely and efficiently operate the extensive features and functions of your new appliance. Please store the manual in a safe location close to the appliance for future reference. Use this appliance only for its intended purpose as described in this instruction manual.

Warnings and Important Safety Instructions in this manual do not cover all possible conditions and situations that may occur. It is your responsibility to use common sense, caution and care when installing, maintaining and operating your washer.

Because the following operating instructions cover various models, the characteristics of your washer may differ slightly from those described in this manual and not all warning signs may be applicable. If you have any questions or concerns, contact your nearest service center or find help and information online at www.samsung.com.

Important safety symbols

What the icons and signs in this user manual mean:

WARNING

Hazards or unsafe practices that may result in **severe personal injury, death and/or property damage**.

CAUTION

Hazards or unsafe practices that may result in **personal injury and/or property damage**.

NOTE

Indicates that a risk of personal injury or material damage exists.

SAVE THESE INSTRUCTIONS



These warning signs are here to prevent injury to yourself and others.
Please follow them explicitly.
After reading this manual, store it in a safe place for future reference.

Read all instructions before using the appliance.

As with any equipment that uses electricity and moving parts, potential hazards exist. To safely operate this appliance, familiarize yourself with its operation and exercise care when using it.

WARNING

State of California Proposition 65 Warning (US only)

This product contains chemicals known to the State of California to cause cancer and birth defects or other reproductive harm.

Important safety precautions

WARNING

To reduce the risk of fire, electric shock, or injury to persons when using your appliance, follow basic precautions, including the following:

1. Read all instructions before using this appliance.
2. Do not wash or dry articles that have been previously cleaned in, washed in, soaked in, or spotted with gasoline, dry-cleaning solvents, other flammable or explosive substances as they give off vapors that could ignite or explode.
3. Do not allow children to play on or in the appliance. Close supervision of children is necessary when the appliance is used near children.
4. Before the appliance is removed from service or discarded, remove the lid of the washing or drying compartment.
5. Do not reach into the appliance if the drum is moving.
6. Do not install or store this appliance where it will be exposed to the weather.
7. Do not tamper with the controls.
8. Do not repair or replace any part of the appliance or attempt any servicing unless it is specifically recommended in the user-maintenance instructions or in published user-repair instructions that you understand and have the skills to carry out.
9. Do not add gasoline, dry-cleaning solvents, or other flammable or explosive substances to the wash water. These substances give off vapors that could ignite or explode.

SAVE THESE INSTRUCTIONS

Safety information

- 10.** Under certain conditions, hydrogen gas may be produced in a hot water system that has not been used for 2 weeks or more. **HYDROGEN GAS IS EXPLOSIVE.** If the hot water system has not been used for 2 weeks or more, before using a washer or combination washer-dryer, turn on all hot water faucets and let the water flow from each for several minutes. This will release any accumulated hydrogen gas. As the gas is flammable, do not smoke or use an open flame during this time.

Critical installation warnings

WARNING

Plug the power cord into an AC 120 V / 60 Hz/wall socket rated at 15 amps or higher. Use the socket for this appliance only. In addition, do not use an extension cord.

- Sharing a wall socket with other appliances, using a power strip, or extending the power cord may result in electric shock or fire.
- Do not use an electric transformer. It may result in electric shock or fire.
- Ensure that the power voltage, frequency, and current match the product's specifications. Failing to do so may result in electric shock or fire.

Have this appliance installed by a qualified technician or service company.

- Failing to do so may result in electric shock, fire, an explosion, problems with the product, or injury.

Remove all foreign substances such as dust or water from the power plug terminals and contact points using a dry cloth on a regular basis.

- Unplug the power plug and clean it with a dry cloth.
- Failing to do so may result in electric shock or fire.

Plug the power plug into the wall socket in the right direction so that the cord runs towards the floor.

- If you plug the power plug into the socket in the opposite direction, the electric wires within the cable may be damaged and this may result in electric shock or fire.

This appliance must be properly grounded.

Do not ground the appliance to a gas pipe, plastic water pipe, or telephone line.

- Improper grounding may result in electric shock, fire, an explosion, or problems with the product.

SAVE THESE INSTRUCTIONS



- Never plug the power cord into a socket that is not grounded correctly. Make sure the socket you use is grounded in accordance with local and national codes.

Do not install this appliance near a heater or flammable material.

Do not install this appliance in a humid, oily, or dusty location, or in a location exposed to direct sunlight or water (rain drops).

Do not install this appliance in a location where gas may leak.

- This may result in electric shock or fire.

Plug the power plug into the wall socket firmly. Do not use a damaged power plug, damaged power cord, or loose wall socket.

- This may result in electric shock or fire.

Do not pull or excessively bend the power cord.

Do not twist or tie the power cord.

Do not hook the power cord over a metal object, place a heavy object on the power cord, insert the power cord between objects, or push the power cord into the space behind the appliance.

- This may result in electric shock or fire.

Do not pull the power cord when unplugging the power plug.

- Unplug the power plug by holding the plug.
- Failing to do so may result in electric shock or fire.

If the power plug or power cord are damaged, contact your nearest service center.

Installation cautions

CAUTION

Position the appliance so that the power plug is easily accessible.

- Failing to do so may result in electric shock or fire due to electric leakage.

Install your appliance on a level and hard floor that can support its weight.

- Failing to do so may result in abnormal vibrations, noise, or problems with the product.

Unplug the power plug when the appliance is not being used for long periods of time or during a thunder/lightning storm.

- Failing to do so may result in electric shock or fire.

SAVE THESE INSTRUCTIONS

Safety information

Critical usage warnings

WARNING

If the appliance is flooded, cut the power immediately and contact your nearest service center.

If the appliance emits a strange noise, a burning smell, or smoke, unplug the power plug immediately and contact your nearest service center.

- Failing to do so may result in electric shock or fire.

In the event of a gas leak (such as propane gas, LP gas, etc.), ventilate the area immediately. Do not turn any appliance or light on or off.

- Do not use a ventilating fan.
- A spark may result in an explosion or fire.

Do not wash items contaminated with gasoline, kerosene, benzene, paint thinner, alcohol or other flammable or explosive substances.

- This may result in electric shock, fire, or an explosion.

Do not force the washer lid open while the washer is operating (high-temperature washing/drying/spinning).

- Water flowing out of the washer may cause burns or cause the floor to be slippery. This may result in injury.
- Forcing the lid open can damage the product or cause injury.

Make sure to remove the packaging (sponge, styrofoam) attached to the bottom of the washer before using it.

Do not insert your hand under the washer.

- This may result in injury.

Do not touch the power plug with wet hands.

- This may result in electric shock.

Do not turn the appliance off by unplugging the power plug while the washer is in operation.

- Plugging the power plug into the wall socket again may cause a spark and result in electric shock or fire.

Keep all packaging materials well out of the reach of children, as packaging materials can be dangerous to children.

- If a child places a bag over their head, the child may suffocate.

SAVE THESE INSTRUCTIONS



Do not let children or infirm persons use this washer unsupervised.

- Failing to do so may result in electric shock, burns or injury.

Do not insert your hand or a metal object under the washer while it is operating.

- This may result in injury.

Do not attempt to repair, disassemble, or modify the appliance yourself.

- Do not use any fuse (such as copper, steel wire, etc.) other than the standard fuse.
- If you need to repair or reinstall the appliance, contact your nearest service center.
- Failing to do so may result in electric shock, fire, problems with the product, or injury.

If any foreign substance such as water enters the appliance in any area other than the tub, unplug the power plug and contact your nearest service center.

- Failing to do so may result in electric shock or fire.

If the water supply hose comes loose from the faucet and floods the appliance, unplug the power plug.

- Failing to do so may result in electric shock or fire.

Usage cautions

CAUTION

If the washer is contaminated by a foreign substance such as detergent, dirt, food waste, etc., unplug the power plug and clean the washer using a damp, soft cloth.

- Failing to do so may result in discoloration, deformation, damage or rust.

The clear portion of the lid can be broken by a strong impact. Take care when using the washer.

- If the clear portion is cracked or broken, it may result in injury.

After a water supply failure or when reconnecting the water supply hose, open the faucet slowly.

Open the faucet slowly after a long period of non-use.

- The air pressure in the water supply hose or the water pipe may result in damage to a part or in water leakage.

If a drain error occurs during an operation, check if there is a draining problem.

SAVE THESE INSTRUCTIONS

Safety information

- If the washer is used when it is flooded because of a draining problem, it may result in electric shock or fire due to electric leakage.

Do not insert your hand under the washer.

- This may result in injury.

Insert the laundry into the washer completely so that laundry does not get caught in the lid.

- If laundry gets caught in the lid, it may result in damage to the laundry or the washer, or result in water leakage.

Ensure that the faucet is turned off when the washer is not being used.

- Ensure that the water supply hose connectors are properly tightened.
- Failing to do so may result in property damage or injury.

Open the faucet and check if the water supply hose connector is firmly tightened and that there is no water leaking before using the product.

- If the water supply hose connectors are loose, it may result in water leakage.

Do not stand on top of the appliance or place objects (such as laundry, lighted candles, lighted cigarettes, dishes, chemicals, metal objects, etc.) on the appliance.

- This may result in electric shock, fire, problems with the product, or injury.

Do not operate the appliance with wet hands.

- This may result in electric shock.

Do not spray volatile material such as insecticide onto the surface of the appliance.

- As well as being harmful to humans, it may also result in electric shock, fire, or problems with the product.

Do not place an object that generates a electromagnetic field near the washer.

- This may result in injury due to a malfunction.

Since the water drained during a high-temperature wash or drying cycle is hot, do not touch the water.

- This may result in burns or injury.

For waterproof fabrics, only use the WATERPROOF cycle.

- Do not use other cycles for waterproof fabrics.
This may result in injury or damage to the washer, walls, floor, or clothing due to abnormal vibrations.
- Set the temperature and spin according to the attached care label.

Do not operate the washer when the detergent dispenser is removed.

SAVE THESE INSTRUCTIONS



- This may result in electric shock or injury due to water leakage.

Do not insert your hand into the detergent dispenser after opening it.

- This may result in injury as your hand may be caught.

Do not place any non-laundry objects, such as shoes, food waste, or animals into the washer.

- This can cause abnormal vibrations that can damage the washer, and, in the case of pets, cause severe injury or death.

Do not press the buttons using sharp objects such as pins, knives, fingernails, etc.

- This may result in electric shock or injury.

Do not wash laundry contaminated by oils, creams, or lotions usually found in skincare shops or massage clinics.

- This may result in the rubber seal becoming deformed and water leakage.

Do not leave metal objects (safety pins, hair pins, etc.) or bleach in the tub for long periods of time.

- This may cause the tub to rust.
- If rust appears on the surface of the tub, apply a neutral cleansing agent to the surface and use a sponge to clean it. Never use a metal brush.

Do not use dry cleaning detergent directly in the tub and do not wash, rinse, or spin laundry contaminated by dry cleaning detergent.

- This may result in spontaneous combustion or ignition due to heat from the oxidation of the oil.

Do not use hot water from water cooling/heating devices.

- This may result in problems with the washer.

Do not use natural hand-washing soap in the washer.

- If it hardens and accumulates inside the washer, it may cause problems with the product, discoloration, rust, or bad odors.

Do not wash large laundry items such as bedding in the washing net.

- Failing to do so may result in injury due to abnormal vibrations.
- Place smaller items, such as lace socks and lingerie in the washing net.

Do not use hardened detergent.

- If it accumulates inside the washer, it may result in water leakage.

Do not wash throw rugs or doormats.

SAVE THESE INSTRUCTIONS

Safety information

- If you wash throw rugs or doormats, the sand will accumulate inside the washer. It may result in error such as no draining.

Critical cleaning warnings

WARNING

Do not clean the appliance by spraying water directly onto it.

Do not use the strong acid cleaning agent.

Do not use benzene, paint thinner, or alcohol to clean the appliance.

- This may result in discoloration, deformation, damage, electric shock, or fire.

Before cleaning or performing maintenance, unplug the appliance from the wall socket.

- Failing to do so may result in electric shock or fire.

SAVE THESE INSTRUCTIONS

Installation

Follow these instructions carefully to ensure proper installation of the washer and to prevent accidents when using it.

WARNING

Control board, heat sink, motor, inlet valve and pump are intentionally not grounded and may present a risk of electric shock only during servicing.

Unpacking your washer

Unpack your washer and inspect it for shipping damage. Make sure you have received all the items shown below. If your washer was damaged during shipping, or you do not have all of the items, contact 1-800-SAMSUNG (1-800-726-7864).

To prevent personal injury or strain, wear protective gloves whenever lifting or carrying the unit.

WARNING

Packing materials can be dangerous to children; Keep all packing material (plastic bags, polystyrene, etc.) well out of children's reach.

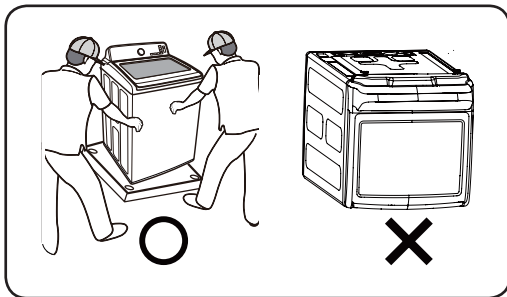

CAUTION

When unpacking the washer, 2 person collaboration is needed. To remove the cushion bottom of the packing materials, forward dumping is strictly prohibited.

When you lay the washer down to remove carton base, should protect the side of washer and lay it carefully. Never lay your washer on its back or front.



Installation

Overview of your washer

Make sure all the parts are included in the product package. If you have a problem with the washer or the parts, contact a local Samsung customer center or the retailer.

Installation

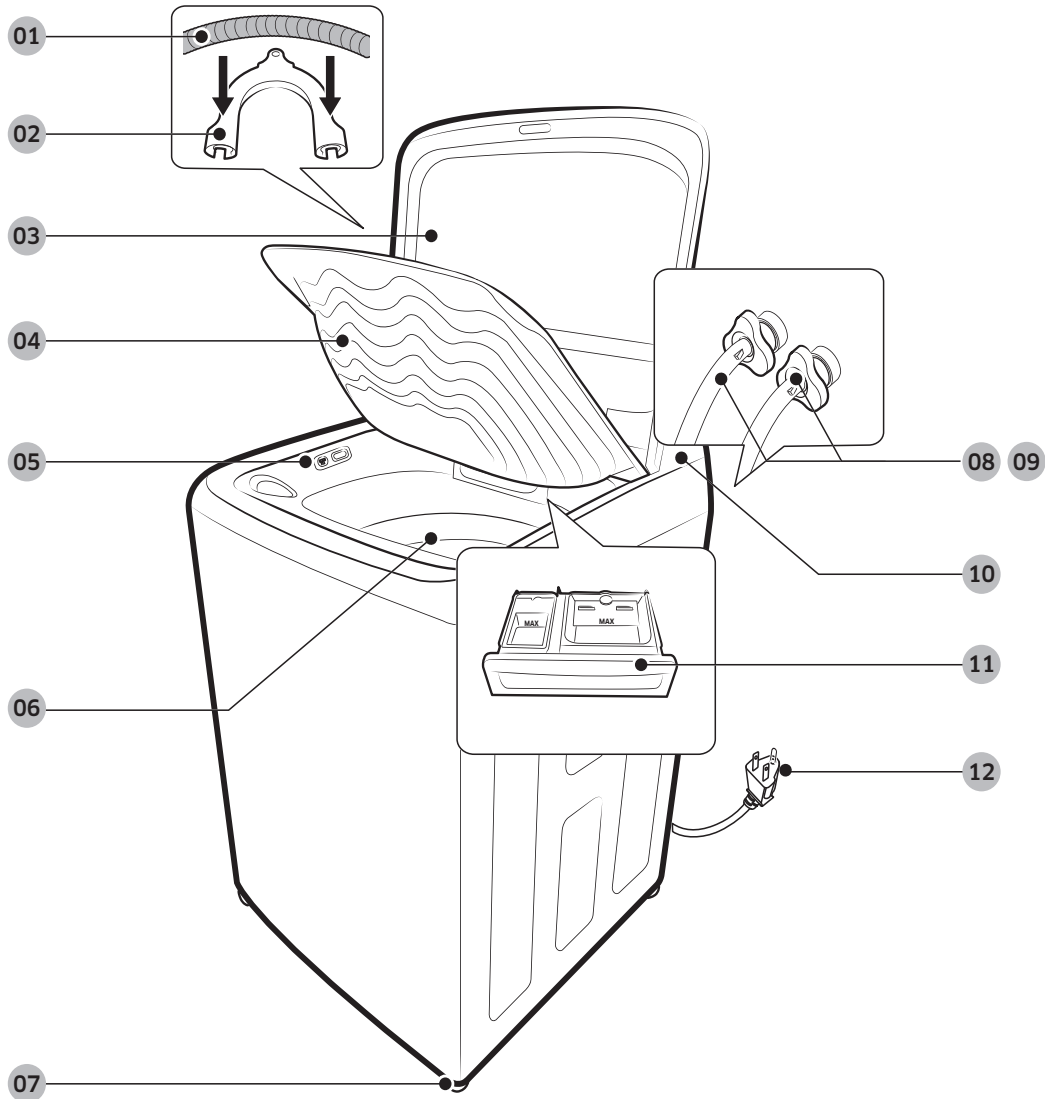

- | | | |
|-------------------------|-----------------------------|----------------------------|
| 01 Drain hose | 02 Hose guide | 03 Lid |
| 04 Built-in sink | 05 Water Jet | 06 Tub |
| 07 Leveling feet | 08 Water hose (Cold) | 09 Water hose (Hot) |
| 10 Control panel | 11 Detergent drawer | 12 Power cord |





Parts supplied

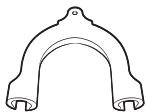

Hose guide

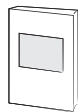

User manual

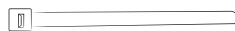

Plastic zip hose tie



Water intake cap

Parts not supplied

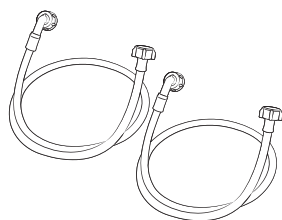

Water hose

Tools needed for installation



Wrench



Philips screwdriver

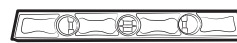

Level



Adjustable Plier

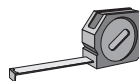

Measuring tape

NOTE

- If you lose an accessory and want to purchase a replacement, contact the Samsung service center (1-800-SAMSUNG (1-800-726-7864)).
- The design of the parts and accessories may differ from the pictures above. Their design is subject to change without notice for product improvement.
- Do not reuse old hoses. Only use new water supply hoses when you install the washer. Old water supply hoses can leak or burst causing flooding and property damage.
- Confirm that there are rubber washers inside each coupling of the water supply hoses.



Installation

Basic location requirements

Electrical

- 120 Volt 60 Hz 15 AMP fuse or circuit breaker.
- Individual branch circuit serving only your Washer is recommended.
- Your washer is equipped with a power cord.

CAUTION

Never use an extension cord.

Grounding

Electrical grounding is required for this appliance.

This appliance must be grounded. In the event of malfunction or breakdown, grounding will reduce the risk of electric shock by providing a path of least resistance for electric current.

This appliance is equipped with a power cord having a three-prong grounding plug for use in a properly installed and grounded outlet.

The plug must be plugged into an appropriate outlet that is properly installed and grounded in accordance with all local codes and ordinances.

WARNING

An improperly connected equipment-grounding conductor can increase the risk of electrical shock. Check with a qualified electrician or serviceman if you are not sure whether the appliance is properly grounded. Do not modify the plug provided with the appliance - if it does not fit the outlet, have a proper outlet installed by a qualified electrician.

Important safety precautions

To prevent unnecessary risk of fire, electrical shock or personal injury, all wiring and grounding must be done in accordance with the National Electrical Code ANSI/FNPA, No.70 Latest Revision and local codes and ordinances. It is the personal responsibility of the appliance owner to provide adequate electrical service for this appliance.

CAUTION

Never connect the ground wire to plastic plumbing lines, gas lines, or hot water pipes.

Water

To correctly fill your Washer in the proper amount of time, water pressure of 20 to 116psi (137 to 800kPa) is required. Water pressure less than 20 psi may cause water valve failure, or may not allow the water valve to shut off completely, or may extend the fill time beyond what your Washer controls allow, causing your Washer to turn off. A time limit is built into the controls to prevent flooding in your home if a hose becomes loose.



The water faucets must be within 4 feet (122 cm) to the back of your Washer to match the inlet hoses provided with your Washer.

NOTE

Accessory inlet hoses are available in various lengths up to 10 feet (275 cm) for faucets that are further away from the back of your washer.

To avoid the possibility of water damage:

- Have water faucets easily accessible.
- Turn off faucets when the washer is not in use.
- Periodically check that there is no leakage from the water inlet hose fittings.

WARNING

Check all connections at the water valve and faucet for leaks

Drain facility

The recommended height of the standpipe is 39 in (99 cm). The drain hose must be routed through the drain hose clip to the standpipe. The standpipe must be large enough to accept the outside diameter of the drain hose. The drain hose is attached to the washer at the factory.

Flooring

For best performance, you must install your washer on a solidly constructed floor. Wood floors may need to be reinforced to minimize vibration and/or unbalanced load situations. Carpeting and soft tile surfaces are contributing factors to vibration which can cause your washer to move slightly during the spin cycle.

Never install your washer on a platform or weakly supported structure.

Location considerations

Do not install your washer in areas where water may freeze, since your washer will always retain some water in its water valve, pump, and hose areas. Frozen water can damage the belts, the pump, hoses, and other components.

Alcove or closet installation

Minimum clearances for closet and alcove installations:

Sides	1 in / 25 mm	Closet front	2 in / 51 mm
Rear	6 in / 152 mm	Top	21 in / 533 mm

If the washer and dryer are installed together, the closet front must have at least a 72 in² (465 cm²) unobstructed air opening. Your washer alone does not require a specific air opening.

Installation

Installation

Recessed area

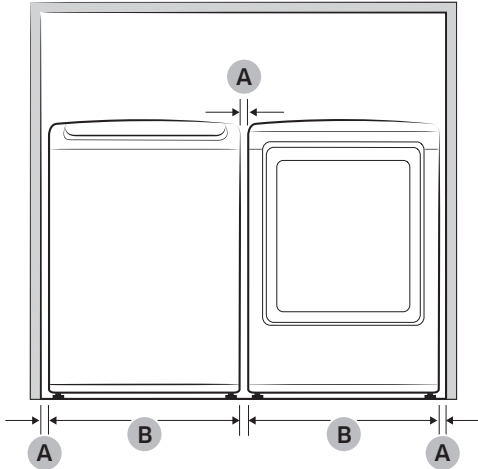

A	1 in (2.5 cm)
B	27.0 in (68.6 cm)

Side view - closet or confined area

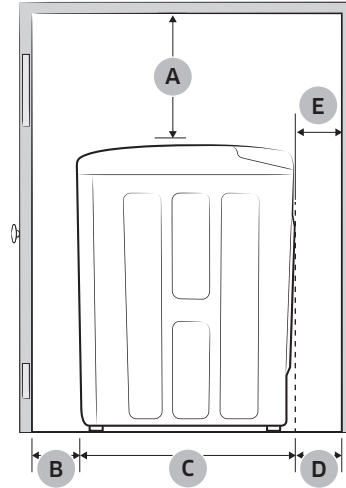

A	21 in (53.3 cm)
B	2 in (5.1 cm)
C	29 7/16 in (74.4 cm)
D	6 in (15.2 cm)
E	<p>Gap between end of water valve and the wall</p> <ul style="list-style-type: none"> Case 1. Assemble supply hose after installing : Over 4 in (10 cm). Case 2. Assemble supply hose before installing : Over 3 in (8 cm).



Required dimensions for Installation

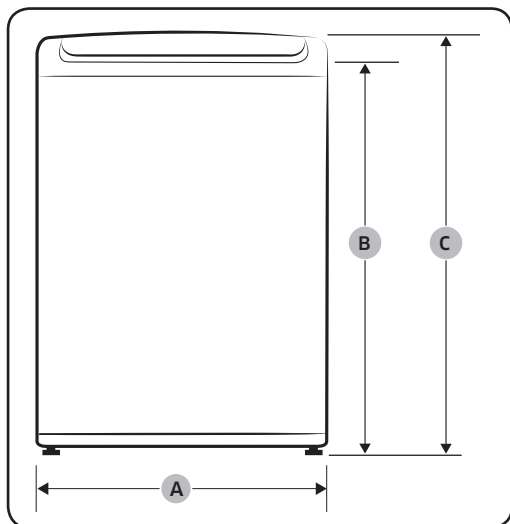

A	27.0 in (68.6 cm)
B	39.2 in (99.5 cm)
C	42.4 in (107.7 cm)

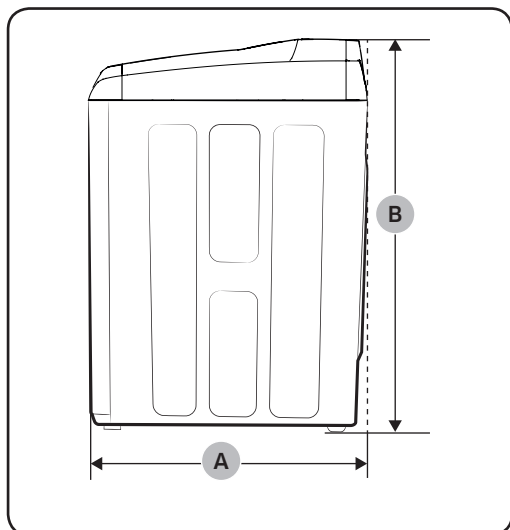

A	29.3 in (74.4 cm)
B	42.4 in (107.7 cm)

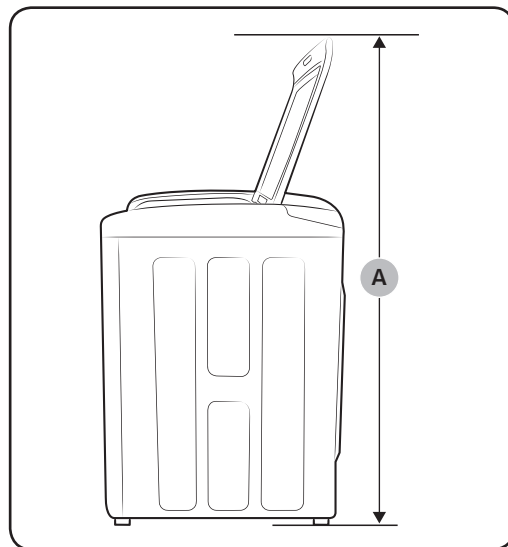

A	61.0 in (155.0 cm)
---	--------------------

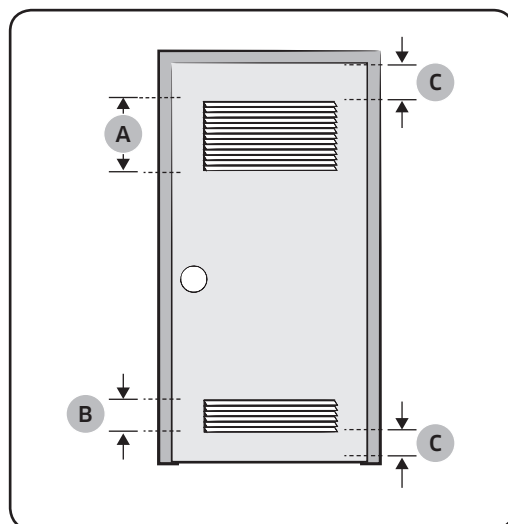

A*	48.0 in ² (310.0 cm ²)
B*	24.0 in ² (155.0 cm ²)
C	3.0 in (7.6 cm)

NOTE

* Required spacing

Installation

Important note to installer

Please read the following instructions carefully before installing your washer. These instructions should be retained for future reference. We recommend you hire a professional to install this washer.

Installation flow chart

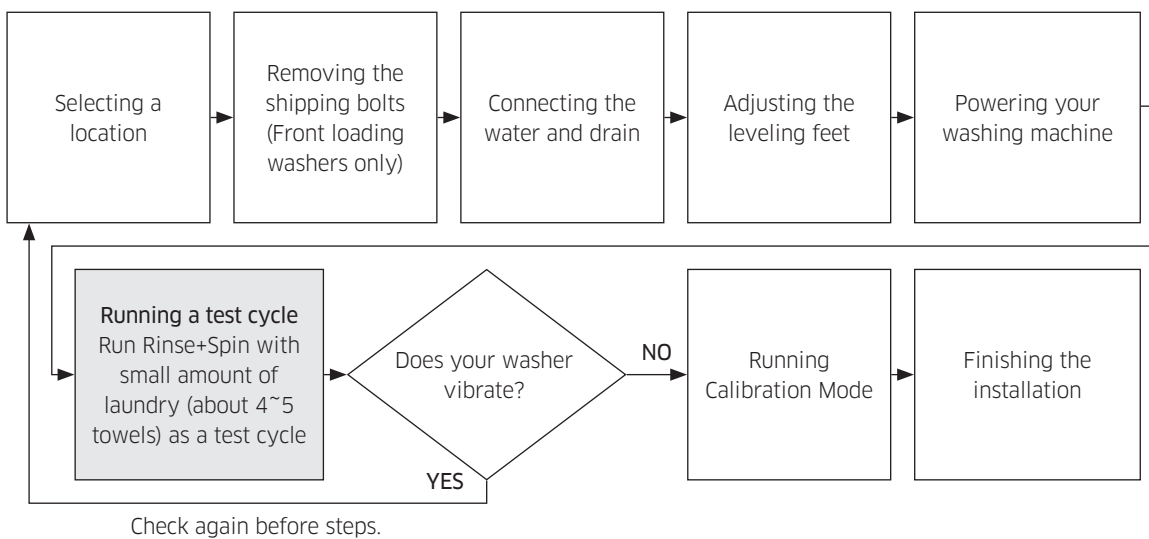

Step-by-step installation

STEP 1 Selecting a location

NOTE

Before you install the washer, make sure the location:

- Has a hard, level surface without carpeting or flooring that may obstruct ventilation.
- Is away from direct sunlight.
- Has adequate ventilation.
- Is not exposed to freezing temperatures (temperatures under 32 °F or 0 °C).
- Is away from heat sources such as oil or gas.
- Has enough space so that the washer doesn't rest on its power cord.



STEP 2 Connecting the water supply hose

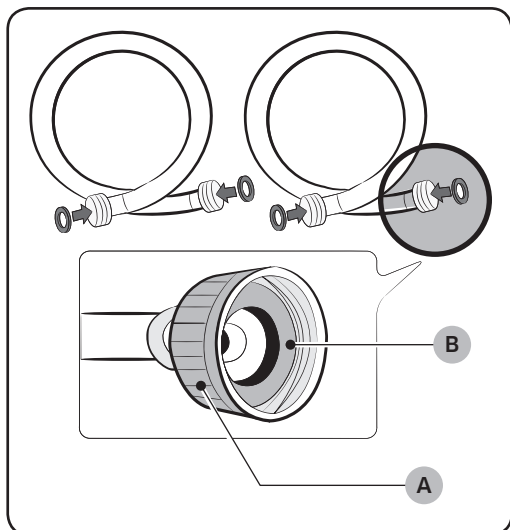

⚠ CAUTION

Before installing the water supply hoses, make sure there are **rubber gaskets (B)** inside the **couplings (A)** at both ends of each new water hose. Installing the water supply hoses without rubber gaskets can cause water leakage.

⚠ CAUTION

When you initially install the washer, be sure to use new hoses. Failing to do so may result in a water leakage or overflow and may damage your property.

⚠ CAUTION

Do not connect multiple water supply hoses together to increase the length of the supply hose. Hoses connected this way can leak and the leakage can cause electrical shock. If a hose is too short, replace the hose with a longer, high pressure hose.



Installation

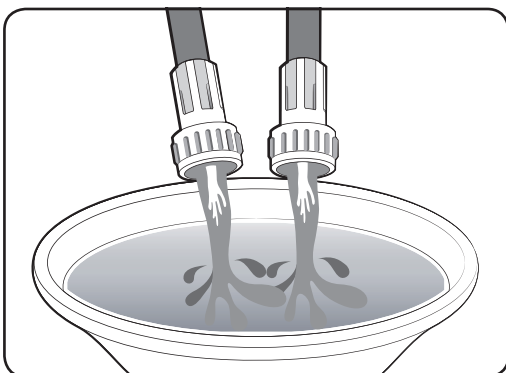
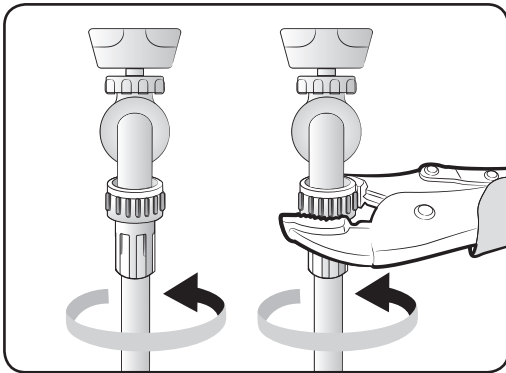
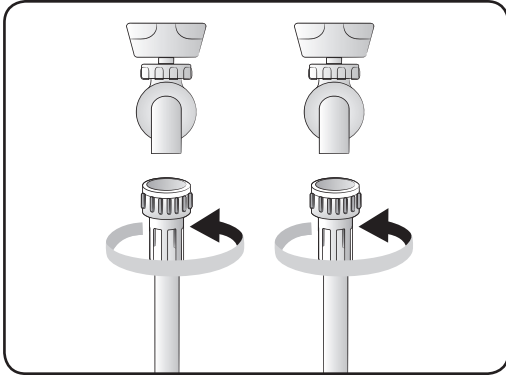

1. Connect the ends of the water supply hoses to the hot and cold faucets.
2. Tighten the fittings by hand until they are snug, and then tighten them an additional two-thirds of a turn with a plier.

CAUTION

When you fasten the fittings, do not fasten them too tightly or apply tape or sealant to the faucets or water supply intakes. This can damage the fittings.

NOTE

After you have connected the water supply hoses to the faucets, ensure that they are connected correctly by pulling the water supply hoses downwards.

3. Place the unconnected ends of the hoses into a bucket and open the faucets connected to the two water supply hoses for 10 or 15 seconds to remove any foreign substances from the hoses. Close the faucets before continuing.



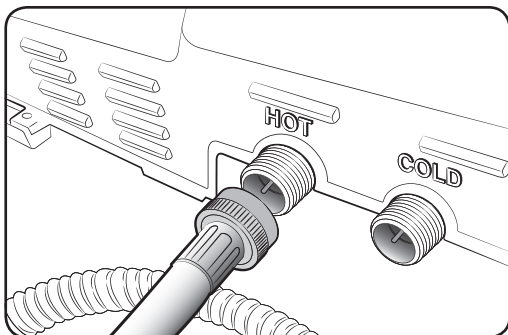

4. Connect the ends of the water supply hoses to the water supply intake connections at the back of the washer.

⚠ CAUTION

The water supply hose connected to the hot faucet must be connected to the hot water supply intake and the water hose connected to the cold faucet must be connected to the cold water supply intake.

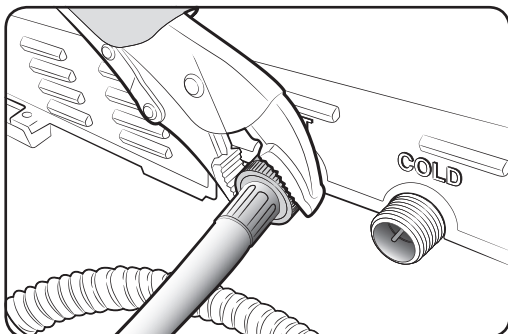

5. Tighten the fittings by hand until they are snug, and then tighten them an additional two-thirds of a turn with a plier.

📖 NOTE

To ensure the correct water usage, connect both the hot and cold water faucets. If either or both are not connected, an “4C” (no fill) code can be displayed.

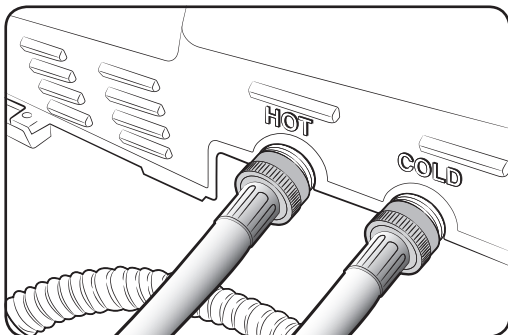

📖 NOTE

If you do not want to use the hot water supply hose, insert the water intake cap into the hot water supply intake hole. In this case, you must select the **Tap Cold** for the water temperature. If you select the **Tap Cold**, all the lamps for the water temperature options are turned off.

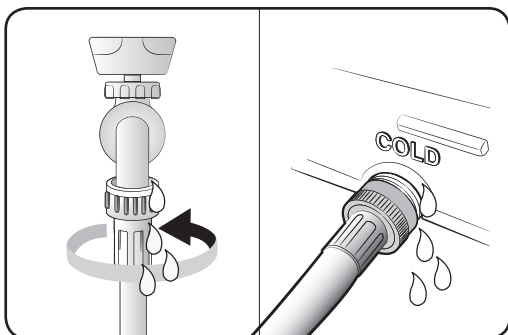

⚠ CAUTION

Confirm that the water supply hoses are not twisted or bent. If the hoses are twisted or bent, the hoses can leak and cause electric shock due to the water leakage.

6. Turn on the hot and cold water supplies and check all the water supply intake connections and the faucets for water leaks.



Installation

STEP 3 Connecting the drain hose

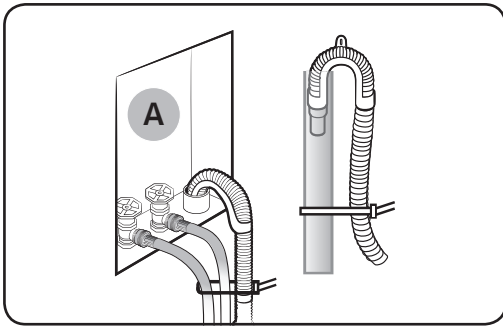

The end of the drain hose can be positioned in three ways:

In a Wall standpipe or Floor standpipe

The height of end of standpipe must be no lower than 39 in (99 cm) and no higher than 96 in (245 cm)

If drain pipe are built into the wall with water valves (A), fasten the drain hose to the water hose.

NOTE

- Make sure that the connection between the drain hose and the standpipe is not airtight.

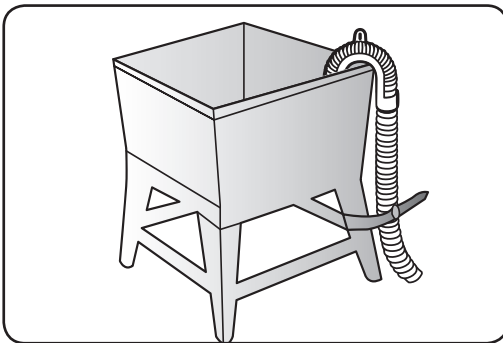

In a laundry tub

The height of the tub must be no lower than 39 in (99 cm) and no higher than 96 in (245 cm)

Assemble the supplied Hose guide at the end of the drain hose, and put the hanger on laundry tub.

And fasten the drain hose to the leg of laundry tub.

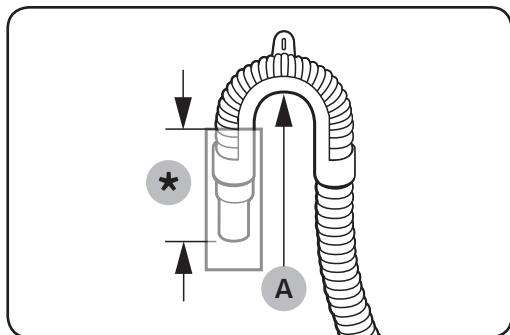
**NOTE**

Connect the **hose guide (A)** within 3~5 in (7.6~12.7 cm)* from the end of the drain hose. If the drain hose is extended beyond the end of the hose guide, mold or microorganisms could spread inside the washer.

NOTE

The drain hose can be installed to a 96 in (245 cm) maximum, but the draining capability can be reduced at this height. It can cause the washer to have an odor because of remaining water in the drain system.

NOTE

If the drain hose is installed below 39 in (99 cm), water can be drained in cycles due to a siphon phenomenon. It causes the washer to display "4C".

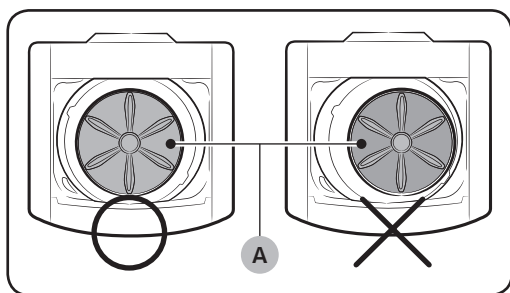
STEP 4 Leveling your washer

See if the washer is level by checking the position of the tub:

1. Slide the washer into position.
2. Open the lid of the washer, and pour the water into the tub to just below the pulsator level.

NOTE

WA52M8650A* models have the Built-in sink over the pulsator level. That's why the level is not revealed. Open the Built-in sink and check the level with eyes.



Installation

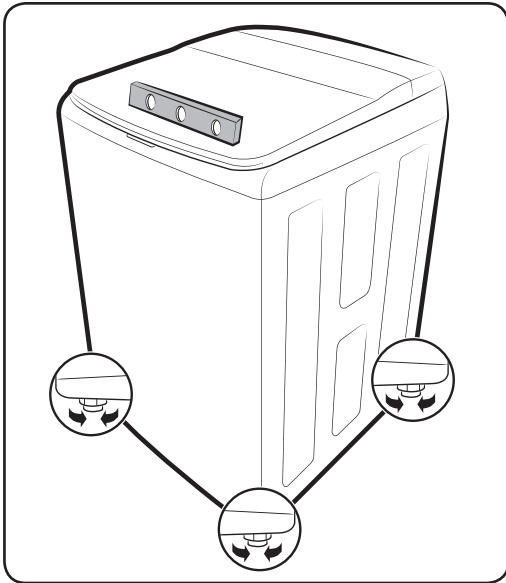

- If the washer is level, the **pulsator (A)** is positioned at the center of the water as shown in the figure.
If not, level your washer by turning the front leveling feet **clockwise (B)** or **counterclockwise (C)** as necessary.

NOTE

Turn the front leveling feet **clockwise (B)** to lower the washer, and **counterclockwise (C)** to raise the washer.

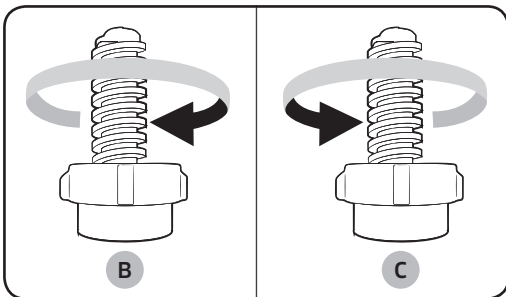

STEP 5 Powering your washer

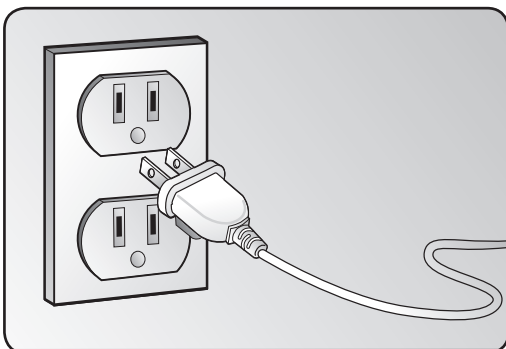

Plug the power cord into a 3-prong, well grounded 120 volt 60 Hz approved electrical outlet protected by a 15-amp fuse or comparable circuit breaker. Your washer is grounded through the third prong of the power cord when plugged into a three-prong grounded electrical outlet.

Test run

Make sure that you install your washer correctly by running the **Rinse+Spin** after the installation is complete.





STEP 6 Running a test cycle

Run a test cycle as follows to check if your washer is properly installed.

1. Load about 6 pounds of laundry into the tub.
2. Press **Power** to turn on your washer.
3. Select **Rinse+Spin** by press the **Cycle Selector**.
4. Press **Start/Pause** to start the test cycle.
5. The washer should not rock or vibrate excessively when water is supplied or when washing or spinning, and should drain well during the spin cycle.

NOTE

If water leaks while water is being supplied or drained, check the water connections. Refer to the “STEP 2 Connecting the water supply hose” section on page 21 for instructions.

NOTE

If the washer rocks and vibrates excessively, level your washer again. Refer to the “STEP 4 Leveling your washer” section on page 25 for instructions.

STEP 7 Calibration Mode

Your Samsung washer detects the laundry weight automatically.

For more accurate weight detection, please run Calibration Mode after the installation.

To run Calibration Mode, follow these steps:

1. Remove laundry or any contents in the machine.
2. Press **Temp.** and **Delay End** simultaneously for at least 3 seconds when the power is turned on.
3. Press **Start/Pause** to activate Calibration Mode.
4. The pulsator rotates clockwise and counterclockwise approximately 1 minute.
5. When Calibration Mode is finished, “0” appears on the display, and the washer automatically turns off. The washer is now ready for use.



Operating instructions

WARNING

To reduce the risk of fire, electric shock, or injury to persons when using your appliance, follow basic precautions, including the following:

Loading your washer

- Fill the tub with dry, unfolded clothes evenly around in order to enhance washing efficiency and prevent excess wear, or wrinkling of the load.
- For optimal washing performance, make sure the laundry is piled up evenly.
- Wash delicate items such as bras, hosiery, and other lingerie in the Delicates cycle with similar lightweight items.
- When washing big bulky items or a few smaller items that don't fill the tub completely – a rug, a pillow, stuffed toys, or one or two sweaters, for example – add a few towels to improve spin performance.
- Do not insert bulky items except for Bedding in this cycle.

NOTE

During the spin cycle, the washer may add additional water to redistribute the clothes and correct an imbalance inside the drum.

- When washing heavily soiled loads, do not overload your washer to ensure good cleaning results.

CAUTION

- Inflatable items may cause damage to the laundry or the machine during the wash or drying process.
- Regardless of the size, blankets or quilts are safer and cleaner to wash one item at a time. Two different-sized blankets in the same load may compromise the drying performance due to unbalanced loads.

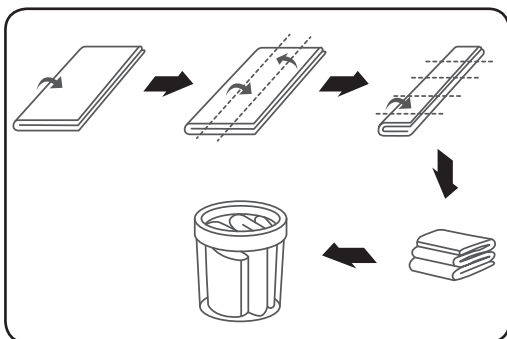

To input a blanket

Fold the blanket into the blanket-specific net as shown, and then insert in the tub below the plastic area of the tub.

CAUTION

Make sure the laundry is inserted completely.

- Any exposed part of the laundry may cause damage to the machine or the laundry itself, or a water leak.
- Do not overload the tub. Make sure no part of the laundry is exposed outside of the tub.



To add a forgotten item:

1. Press **Start/Pause** to pause the washer.
2. Wait for the door to unlock automatically, and then open the door.
3. Add the item, close the door, and then press **Start/Pause**. The cycle will resume.

Getting started

1. Load your washer.
2. Add liquid (or powder) detergent and additives to the dispenser (see the "Detergent use" section on page 41).
3. Select the appropriate cycle and options for the load (see the "Washing a load of laundry" section page 30).
4. Close the lid.
5. Press **Start/Pause**.
6. The **Wash** Indicator illuminates.
7. The estimated cycle time will appear in the display.
The time may fluctuate to indicate the time remaining in the cycle.

NOTE

The actual time required for a cycle may differ from the estimated time in the display depending on the water pressure, water temperature, detergent, and laundry.

8. Before your washer starts to fill, it will make a series of clicking noises to check the door lock and do a quick drain.

NOTE

- When the cycle is complete, the  **Door Lock** indicator will go out and "0" will appear in the display.
- Pressing **Power** cancels the cycle and stops your washer.
- The **Wash**, **Rinse**, and **Spin** indicators will illuminate during those portions of the cycle.

Washing a load of laundry

⚠ WARNING

To reduce the risk of fire, electric shock, or injury to persons, read the IMPORTANT SAFETY INSTRUCTIONS before operating this appliance.

Control panel

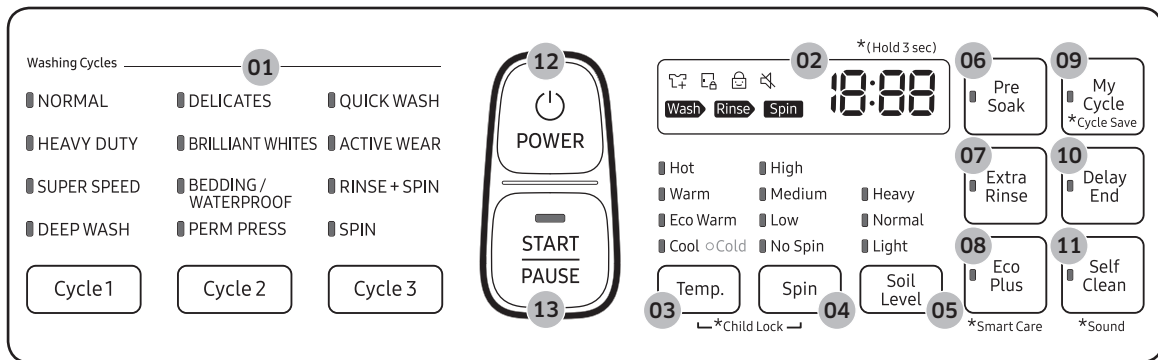

Washing a load of laundry

01 Cycle Selector	Press to select a desired cycle in the left-most panel. When a cycle is selected, the cycle indicator lights up.
02 Display	Provides instructions and diagnostics while keeping you updated on the cycle status and time remaining.
03 Temp.	Press the button repeatedly to cycle through the different water temperature options. <ul style="list-style-type: none"> • Hot - Whites and heavily soiled, colorfast items. • Warm - Colorfast items. • Eco Warm - Moderately soiled, colorfast items; most wrinkle-free items. • Cool - Brightly colored, very lightly soiled items. • Cold - Cold water with no warm water added.
04 Spin	Press the button repeatedly to cycle through the different spin speed options. <ul style="list-style-type: none"> • High - Use for underwear, t-shirts, jeans, and sturdy cottons. • Medium - Use for jeans, wrinkle-free or wash-and-wear items, and synthetics. • Low - Use for delicate items needing a slow spin speed. • No Spin - Drains your washer without spinning. Use for extremely delicate items that cannot tolerate any spin.



05 Soil Level	<p>Press the button to select the soil level/washing time.</p> <ul style="list-style-type: none"> • Heavy - For heavily soiled loads. • Normal - For moderately soiled loads. This setting is best for most loads. • Light - For lightly soiled loads.
06 Pre Soak	It adds 18 minutes soaking time at the start of the wash cycle for better stain removal.
07 Extra Rinse	Change from spray rinse mode to deep rinse mode, and rinse once again.
08 Eco Plus	To increase your energy savings on your wash cycles. (Less hot water consumption)
09 My Cycle	Press for 3 seconds to save your own cycle. Create and/or use a cycle you have customized temperature, spin speed, soil level, options, etc.
10 Delay End	Delay the end of any cycle for up to 24 hours in one-hour increments. Displayed hour indicates the time the wash will be ended.
11 Self Clean	Use to clean dirt and bacteria from the drum. Regular use (after every 20 washes) is recommended. No detergent or bleach is needed.
12 POWER	Press once to turn your washer on. Press again to turn your washer off. If the washer is left on for more than 10 minutes without any buttons being pressed, the power automatically turns off.
13 START/PAUSE	Press to start operation, or press to stop operation.

Washing a load of laundry

 **NOTE**

We recommend that you untangle the items before washing.
Do not put objects on the washer, especially on the feature panel.

Washing a load of laundry

Cycle overview

NOTE

To minimize wrinkling of laundry, select **Perm Press**.

Cycle	Description
Normal	For most fabrics including cottons, linens, and normally soiled garments.
Heavy Duty	For sturdy, colorfast fabrics and heavily soiled garments. We propose to use this function only when washing lot of heavily soiled garments.
Super Speed	Normal soiled and normal loads (up to 8lb).
Deep Wash	Use more water in washing and rinsing.
Delicates	For sheer fabrics, bras, lingerie, silks, and other handwash-only fabrics. For best results, use liquid detergent.
Brilliant Whites	For white fabrics with or without bleach.
Bedding/WaterProof	For bulky and large items, such as comforters, blankets and sheets. When washing comforters, use liquid detergent, waterproof or water-resistant items.  CAUTION <ul style="list-style-type: none">• Do not wash waterproof items and non-waterproof items together.• Check the specification label on the fabric item and see if the item is waterproof.• Use the bedding/waterproof cycle for waterproof or water resistant items such as plastic mats, ski pants, raincoat and comforters which hardly absorb water.
Perm Press	For wash-and-wear, synthetic fabrics, and lightly to normally soiled garments.
Quick Wash	For lightly soiled garments needed quickly.
Active Wear	Use this cycle to wash exercise wear such as sports jerseys, training pants, shirts/tops and other performance clothing. This cycle provides effective soil removal with gentle action for special fabric care.
Rinse + Spin	Use for loads that need rinsing only or to add rinse-added fabric softener to a load.
Spin	Drains the water and spins at a high speed.



Options

Child Lock

Child Lock prevents children from playing with your washer.

Activating the Child Lock function

Press **Temp.** and **Spin** simultaneously for approximately 3 seconds.

- When you activate the Child Lock function, the  **Child Lock** indicator blinks.

Using the Child Lock function

If the lid is opened when the Child Lock function is on, “**dc**” is displayed and an alarm sounds.

- If the water level in the tub is above the safe water level, “**dc**” is displayed on the LED display and the washer starts to drain water by force after 30 seconds.
- If the water level in the tub is above the safe water level and the Child Lock function is turned on while the door is open, “**CL**” is displayed on the LED display even if the power of the washer is turned off and the washer drains water by force.
- Even if the power of the washer is turned off, if the lid is opened while the water level in the tub is above the Reset water level, “**CL**” is displayed on the LED display without the alarm sounding and the washer starts to drain water. When the draining operation finishes, the power is automatically turned off again.
- You have activated the Child Lock function while the washer is running, the **Start/Pause** button will not work.

- After the compulsory drain, the “**CL**” blinks at 1 second intervals and the product enters the “**CL**” mode. (When the product is in the “**CL**” mode, only the **Power** button works.)
- To cancel the “**CL**” mode, you need to turn the power off and then on again.
- To cancel the “**dc**” mode, deactivate the Child Lock function. To deactivate the Child Lock function, press **Temp.** and **Spin** simultaneously for at least 3 seconds.

NOTE

Adding laundry when Child Lock is on

To add laundry, deactivate the Child Lock function. To deactivate the Child Lock function, press **Temp.** and **Spin** simultaneously for at least 3 seconds. See the “**Pause Option**” section on page 37 for additional details.

Deactivating the Child Lock function

Press both **Temp.** and **Spin** simultaneously for approximately 3 seconds.

- When you deactivate the Child Lock function, the  **Child Lock** indicator is turned off.
- The Child Lock function prevents children or the infirm from accidentally operating the washer and injuring themselves.

WARNING

If a child enters the washer, the child may become trapped and suffocate.



Washing a load of laundry

CAUTION

- Once you have activated the Child Lock function, it continues working even if the power is turned off.
- Forcing the lid open can result in injury or damage to the product.

NOTE

To add laundry after you have activated the Child Lock function, you must first deactivate the Child Lock function.

Sound

The Sound Off function can be selected during all cycles.

Garment Plus

You can add or take out laundry items even after the wash has started, as long as the  Garment Plus indicator is on. Pressing **Start/Pause** unlocks the lid. If you open the lid and want to continue the wash cycle, close the lid, and then press **Start/Pause**.

NOTE

If you have activated the Child Lock, you must deactivate it first. See page 33.

My Cycle

Lets you save a custom wash cycle (temperature, spin, soil level, etc.) and then recall and use it with one button convenience.

To save a cycle and selected options as your My Cycle, follow these steps:

1. Press **Power**.
2. Select a cycle using the **Cycle Selector**.
3. After cycle selection, set each option.

NOTE

See the “Cycle chart” section on page 61 for available option settings with each cycle.

4. You can then store the selected cycle and options by pressing and holding **My Cycle** for longer than 3 seconds. The cycle and options you select will be displayed the next time you choose the My Cycle function.
5. Press **My Cycle** to load and use the saved My Cycle options. The “My Cycle” light will indicate activation. Also, the chosen cycle and option lights will flicker.

NOTE

You can change the My Cycle settings by repeating the process above. The last saved settings will be displayed the next time you choose the My Cycle function.

NOTE

If you press **My Cycle** and release it within 3 seconds, the previously saved cycle and options appear. If you press **My Cycle** for 3 second or longer, the currently set cycle and options are saved and the LED blinks for 3 seconds.



Delay End

You can set the washer to start your wash automatically at a later time, by choosing a delay time.

The hour displayed indicates the time at which the wash will be ended.

1. Set your wash cycle.
2. Press **Delay End** repeatedly until the delay time is set.
3. Press **Start/Pause**. The “Delay End” indicator will be lit, and the clock will begin counting down until it reaches the set time.
4. To cancel a Delay End function, press the Power button and then turn the washer on again.

Pre Soak

Use this function when the laundry is heavily contaminated or stained. This function improves the wash performance by adding a Pre Soak cycle.

- If you select this function, the total cycle time is increased by 18 minutes.
- When the Pre Soak cycle starts, the washer repeats a wash cycle after supplying water and then performs a 18-minute soak cycle.
- When the Pre Soak cycle is complete, the configured wash cycle starts without draining water.

Eco Plus

This function sets the temperature somewhat lower than the typical washing cycle and extends the wash time slightly. With laundry time slightly extended, it's possible to keep the same level of washing performance with cooler water. This function reduces energy consumption and maintains the quality of the wash.

Mist Shower

Mist Shower sprays water from a nozzle that is independent of the main water supply system. It states that it soaks the laundry with water from the beginning of the rinse cycle and ensures an effective wash, but it's not part of the wash cycle, it's part of the rinse cycle, so this needs to state that it ensures an effective rinse.

(The Mist Shower function may not work if there is too large of a load in the machine.)



Washing a load of laundry

Smart Care

This function enables you to check the status of the washer using a smartphone.

1. To enable the Smart Care function, press **Fabric Softener** for 3 seconds after turning the power on or when an error occurs.

NOTE

The error code history is deleted after you use this function.

2. The Smart Care indicator is lit on the display.
3. Run the Smart Care app on your smart phone.
 - Android: Galaxy S series, Galaxy Note series. (Other devices may not be normal operation).
Supported OS : Android 2.2 or higher
 - iOS: iPhone series
Supported OS : iOS 4.3 or higher
4. Focus your smart phone's camera on the display panel of the washer.
5. If the smart phone's camera is focused on the display panel of the washer, the panel and error message is automatically recognized and the error type and countermeasures are displayed on the smart phone.
6. If the smartphone fails to recognize the error code more than twice, please enter the error code displayed on the display panel of the washer manually into the Smart Care app.

NOTE

Downloading the Smart Care app

- Download the Samsung Laundry App into your mobile phone from the Android market or Apple App store. (Search word : Samsung Smart Washer/Dryer)

NOTE

Precautions when using Smart Care

- If light from a light bulb, fluorescent bulb, or lamp is reflected on the display panel of the washer, the smartphone may not be able to recognize the panel or error message easily.
- If you hold the smartphone at too large an angle relative to the front of the display panel, it may not be able to recognize the error code. For best results, hold the smartphone so that the front of the panel and the smartphone are parallel or nearly parallel.



Washing clothes using the option button

Your new washer makes washing clothes easy, using Samsung's "Fuzzy Control" automatic control system. When you select a wash program, the machine will set the correct temperature, washing time, and washing speed.

1. Press **Power**.
2. Open the lid.
3. Load the articles of clothing one at a time loosely into the drum, without overfilling it.
4. Add liquid (or powder) detergent, softener, and/or bleach (if necessary) to the appropriate compartments. See the "Detergent use" section on page 41.
5. Close the lid.
6. Use the **option button** to select the appropriate cycle according to the type of material: **Normal**, **Heavy Duty**, **Delicates**, **Deep Wash**, **Super Speed**, **Bedding/WaterProof**, **Perm Press**, **Brilliant Whites**, **Quick Wash**, **Active Wear**, **Rinse+Spin**, and **Spin**. The relevant indicators will illuminate on the control panel.
7. At this time, you can control the wash temperature, the number of rinse cycles, the spinning speed, and the delay time by pressing the appropriate option button.
8. Press **Start/Pause** and the wash will begin. The process indicator will light up and the remaining time for the cycle will appear in the display.

Pause Option

To remove or add laundry items, follow these steps:

1. Press **Start/Pause** to unlock the lid.

NOTE

The lid cannot be opened when the water is too HOT.

2. Remove or add laundry items.
3. Close the lid, and then press **Start/Pause** to restart the wash.

NOTE

If you have Child Lock on, you must deactivate it first. See page 33.

When the cycle is finished:

After the total cycle has finished, the power will turn off automatically.

1. Open the lid.
2. Remove laundry.

Washing a load of laundry

ATC (Auto Temperature Control)

ATC is the control function that the washer controls water temperature with temperature sensor (thermistor).

NOTE

Because there are numerous water temperatures depending on the customer's environments (cold areas, warm areas, various water temperatures, settings of heater temperature, etc.), ATC function in our washer maintains the certain level of wash temperature to output the best washing performance at each cycle.

NOTE

If you select **NORMAL** cycle, this cycle is the regulation and UL cycle. Since new washers must reduce the amount of energy usage as a first priority, customers will notice more cold water entering the washer. But, this is normal, not a problem.

In those regulation cycles, Hot temperature is similar to acceptable adult bath-water temperature and warm temperature is similar to comfortable swimming-pool water temperature.

NOTE

If customers want to wash clothes in specific water temperatures, customers should choose a different cycle at each temperature (Hot/Warm/Eco Warm).



The basics

Prewash (Water Jet & Built-in sink)

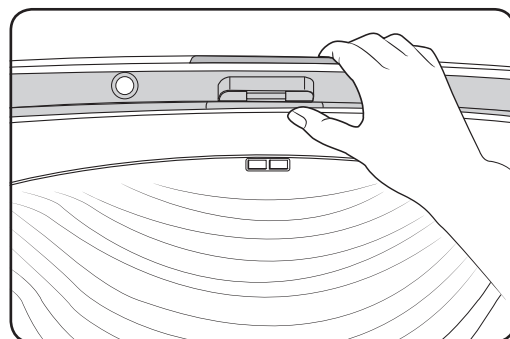
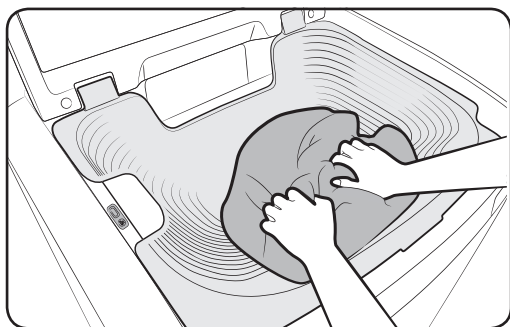
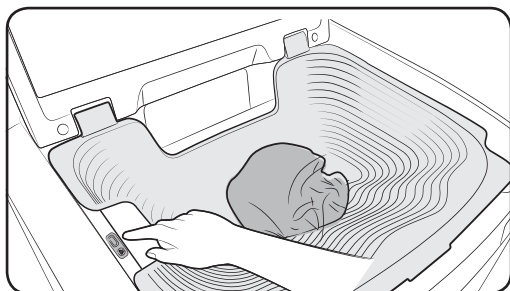
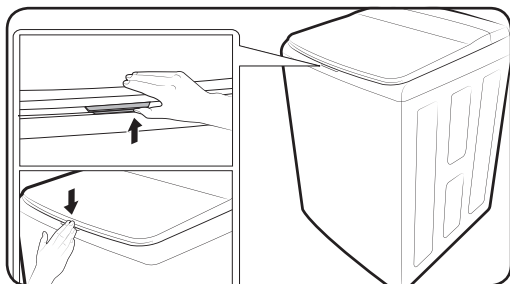

Water Jet and Built-in sink help you handwash before the washing machine starts operation. Water Jet is available only when the door is open with the water level set to less than High. For prewashing, use the Built-in sink that is designed to facilitate the hand-wash.

1. With the door open, lower the Built-in sink . To open only the door, press and release the front middle of the door. **To close and lock both the door and the Built-in sink, press down the door until you hear a clicking sound.**
2. Put clothes to prewash in it.
3. Press Water Jet to supply water to the Built-in sink, and hand-wash.
4. When done, gently lift up the Built-in sink to drain water into the tub.

NOTE

- If you want to hand-wash while the machine is operating, press Start/Pause to stop operation, and then follow steps 1-4 above.
- If you open both the door and the Built-in sink, lower the Built-in sink manually for prewashing.

[Water Jet stops]

- Water Jet stops operation automatically when the washing machine detects the maximum water level.
- Water Jet stops operation automatically 5 minutes after it begins. To add more water, press Water Jet again to resupply water.

Washing a load of laundry

[Water Jet drains]

- Select a cycle and press Start/Pause. Then the washing machine drains the water to be used during the prewash.
- When the washing machine is turned off before starting the wash cycle, it drains the water to be used during the prewash. However, when it is turned off during the wash cycle, it does not drain the water.

NOTE

- Water Jet extracts the water through the Mist Shower nozzle for 1 second and then through the Water Jet nozzle from then on when it is first activated after the washing machine turns on.

CAUTION

- Do not abuse Water Jet. Excessive use of Water Jet increases water consumption.
- When running water to the tub, do that gently. Otherwise, water may overflow the tub.
- Use caution when removing laundry from the tub. You may bump your head on the Built-in sink.
- Do not block the outlet of Water Jet with hands. Water may leak outside the tub, causing a system failure.
- Put only clothes to prewash in the Built-in sink. Other items such as shoes, food, or animals can not be used for prewash.
- Do not open the Built-in sink in a hurry. Remaining water in the sink may splash on the door or control panel.
- Due to a difference in air pressure, Water Jet may splash water from its outlet when it is first activated.
- This lid must be closed tightly to do the laundry.



Detergent use



Your washer is designed to use high efficiency (HE) detergents.

- For the best cleaning results, use a high efficiency detergent such as Tide HE, Wisk HE, Cheer HE or Gain HE*. High efficiency detergents contain suds suppressors that reduce or eliminate suds. When fewer suds are produced, the load tumbles more efficiently and cleaning is maximized. (* Brand names are trademarks of their respective manufacturers.)

 **WARNING**

Regular detergent is not recommended. Use HE detergents only.

 **NOTE**

Reducing the amount of detergent may reduce the quality of cleaning. It is important to pre-treat stains, sort carefully by color and soil level, and avoid overloading.



Washing a load of laundry

Features

Automatic dispenser

Your washer has separate compartments for dispensing detergent and color-safe bleach and fabric softener. Add all laundry additives to their respective compartments before starting your washer.

The automatic dispenser must always be in place before you start your washer. DO NOT open the automatic dispenser when your washer is running.

NOTE

- Never exceed the manufacturer's recommendations when adding detergent.
- This compartment holds liquid detergent for the main wash cycle, which is added to the load at the beginning of the cycle.
- When using powdered detergent, remove the liquid detergent compartment from the detergent drawer. The washer will not dispense powdered detergent from the liquid detergent compartment.

To add detergent to the automatic dispenser:

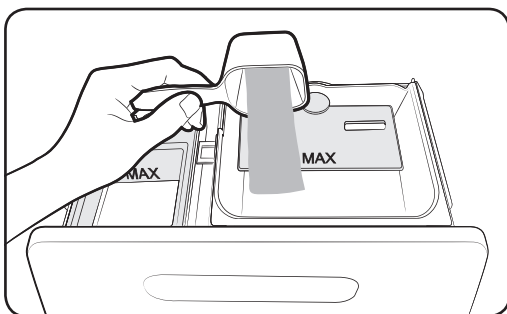

1. Open the dispenser drawer.
2. Load the recommended amount of liquid (or powder) detergent into the detergent compartment before you start your wash.
3. Close the drawer slowly and smoothly to avoid spilling, splashing, or premature dispensing of the contents.

NOTE

It is normal for a small amount of water to remain in the dispenser compartments at the end of the cycle.

NOTE

Do not put chlorine bleach in the dispenser drawer.



Loading the Liquid (or Powder) detergent compartment

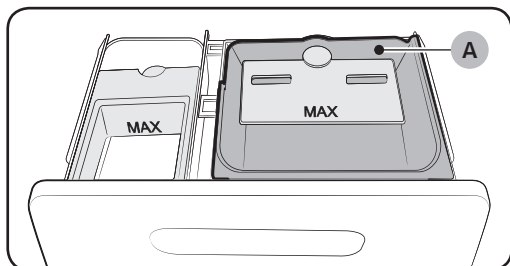

1. Pour the recommended amount of laundry detergent directly into the detergent compartment before starting your washer.
2. If you are using color-safe bleach, add it with the detergent to the detergent compartment.

NOTE

When adding color-safe bleach with detergent, it is best if both laundry products are in the same form - liquid.

NOTE

When using powdered detergent, remove the **liquid detergent compartment (A)** from the detergent drawer. The washer will not dispense powdered detergent from the liquid detergent compartment.

Washing a load of laundry

Loading the Bleach compartment

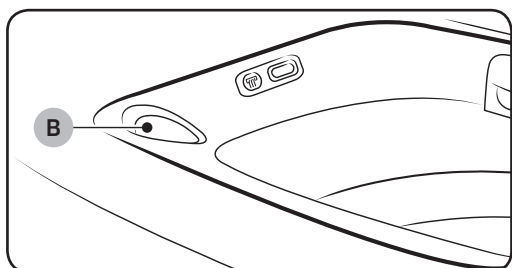

CAUTION

Use the liquid chlorine bleach only.

1. Add chlorine bleach to the **bleach compartment (B)**.
DO NOT exceed the bleach compartment.

NOTE

- Avoid splashing or over-filling the compartment.
- Never pour undiluted liquid chlorine bleach directly onto the load or into the tub. It is a powerful chemical and can cause fabric damage, such as weakening of the fibers or color loss, if not used properly.
- If you prefer to use color-safe, non-chlorine bleach, add it to the appropriate detergent compartment.
DO NOT pour color-safe bleach into the Bleach compartment.



Loading the fabric softener compartment

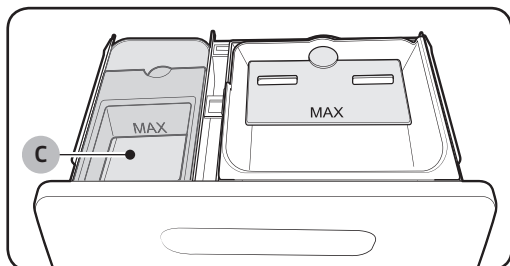

1. Pour the recommended amount of liquid fabric softener into the **softener compartment (C)**.
For smaller loads, use less than one capful.
2. Dilute the fabric softener with water until it reaches MAX FILL in the compartment.
3. The dispenser automatically releases liquid fabric softener at the proper time during the rinse cycle.

NOTE

- Use the softener compartment **ONLY** for liquid fabric softeners.
- **DO NOT** use the Downy Ball* in the fabric softener compartment with this washer. It will not add fabric softener at the appropriate time. Use the detergent compartment.
(* Brand names are trademarks of their respective manufacturers.)
- Do not use liquid fabric softener that is too sticky as it may not mix with the water sufficiently.



Maintaining your washer

WARNING

Control board, heat sink, motor, inlet valve and pump are intentionally not grounded and may present a risk of electric shock only during servicing.

Cleaning the exterior

1. Turn off the water faucets after finishing the day's washing.
This will shut off the water supply to your washer and prevent the unlikely possibility of damage from escaping water. Leave the lid open to allow the inside of your washer to dry out.
2. Use a soft cloth to wipe up all detergent, bleach or other spills as they occur.
3. Clean the following as recommended:
Control Panel - Clean with a soft, damp cloth. Do not use abrasive powders or cleaning pads. Do not spray cleaners directly on the panel.

Cleaning the interior

Clean the interior of your washer periodically to remove any dirt, soil, odor, mold, mildew, or bacterial residue that may remain in your washer as a result of washing clothes.

Failure to follow these instructions may result in unpleasant conditions, including odors and/or permanent stains on your washer or laundry.

Hard water deposits may be removed, if needed. Use cleaners labeled "Washer safe".

Storing your washer

Washers can be damaged if water is not removed from hoses and internal components before storage.

Prepare your washer for storage as follows:

1. Select the Quick Wash cycle and add bleach to the automatic dispenser. Run your washer through the cycle without a load.
2. Turn the water faucets off and disconnect the inlet hoses.
3. Unplug your washer from the electrical outlet and leave your washer lid open to let air circulate inside the drum.
If your washer has been stored in below-freezing temperatures, allow time for any leftover water in your washer to thaw out before use.



Preserving the top cover and the front frame

Do not place any heavy or sharp objects or a detergent box on the washer. They can scratch or damage the top cover of the unit.

NOTE

Since the entire washer has a high-gloss finish, the surface can be scratched or damaged.

Avoid scratching or damaging the surface when using the washer.

Cleaning mesh filter

Clean the mesh filter of the water hose once or twice a year.

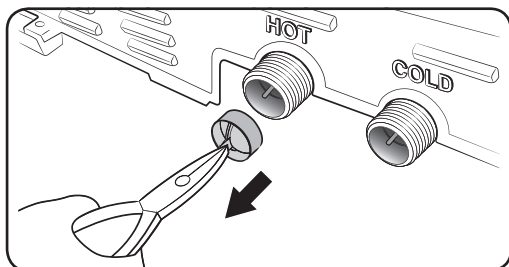
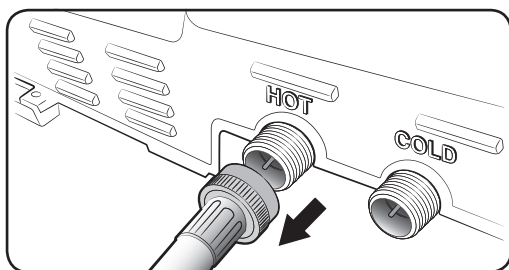

1. Turn off the washer, and then unplug the power cord.
2. Close the faucet.
3. Loosen and disconnect the water hose from the back of the washer. Cover the hose with a cloth to prevent water from gushing out.
4. Use pliers to pull out the mesh filter from the inlet valve.
5. Submerge the mesh filter deeply in water so that the threaded connector is also submerged.
6. Dry the mesh filter completely in a shaded area.
7. Reinsert the mesh filter into the inlet valve, and reconnect the water hose to the inlet valve.
8. Open the faucet.

NOTE

If the mesh filter is clogged, the “4C” information code appears on the the washer’s display screen.

Cleaning the dispensers

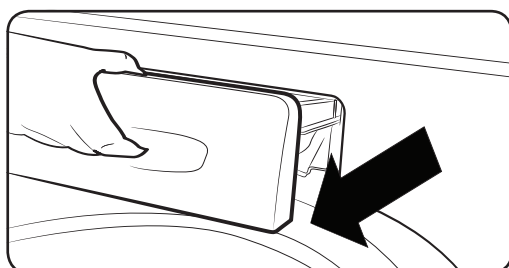

The automatic dispenser may need to be cleaned periodically due to laundry additive buildup.

1. Pull the dispenser drawer straight back until it stops.



Maintaining your washer

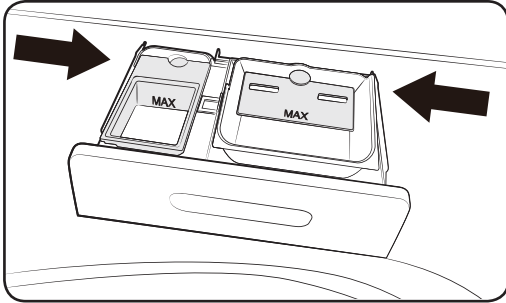

2. Push the ends of each side of the case at the same time.
When you feel the ends push, pull out the dispenser drawer.

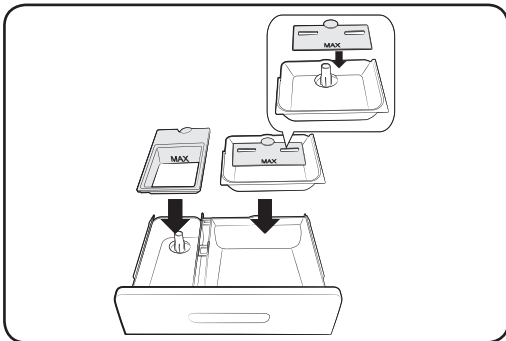

3. Remove the inserts from the 3 compartments. Rinse the inserts and the drawer with warm water to remove traces of accumulated laundry products.

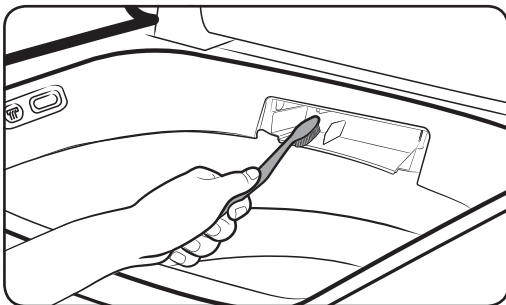

4. To clean the drawer opening, use a small, non-metal brush to clean the recess. Remove all residue from the upper and lower parts of the recess.

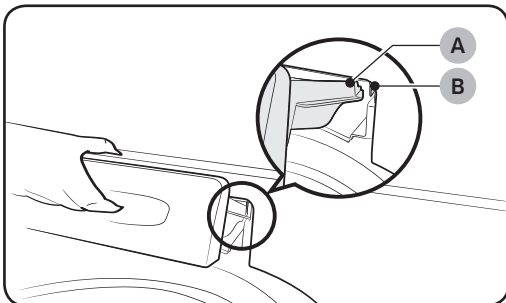

5. Return the inserts to the proper compartments and replace the drawer by placing the **dispenser drawer rail (B)** on top of the **compartment rail (A)** (Tilt the dispenser drawer downward and insert it). Then push the drawer in firmly and slowly.

Self Clean

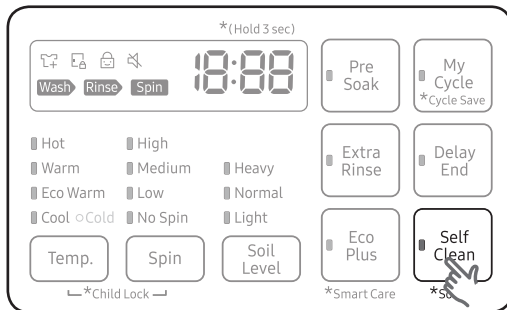

Self Clean is a self-cleaning cycle that removes mold that may occur inside the washer.

1. Press **Power**.
2. Select **Self Clean**.
Once **Self Clean** is selected, the only function that can be set is Delay End.
3. Press **Start/Pause**. Self.

⚠ CAUTION

- Using Self Clean, you can clean the drum without using a cleansing agent.
- Never use Self Clean when laundry is in the washer. This may cause damage to the laundry or a problem with the washer.

📖 NOTE

The Self Clean Auto Led Function

- If the “**Self Clean**” led is lit after a wash, it led that tub (drum) cleaning is required. In this case, remove the laundry from the washing machine, turn the power on, and clean the drum by running Self Clean.
- If you do not run Self Clean, the “**Self Clean**” led turns off. However, the “**Self Clean**” led will light again after five washes. Not running **Self Clean** at this point will not cause a problem with the washing machine.
- Although the Self Clean Auto led appears once a month or so, the frequency may differ depending on the number of times the washing machine is used.

Troubleshooting

Checkpoints

If you encounter a problem with the washer, first check the table below and try the suggestions.

Problem	Action
Does not turn on.	<ul style="list-style-type: none">• Make sure you use rated power for the product.• Make sure the power cord is completely plugged in.• Check the fuse or reset the circuit breaker.
Does not start.	<ul style="list-style-type: none">• Make sure the door is closed.• Make sure the water taps are open.• Make sure to press or tap Start/Pause to start the washing machine.• Make sure Child Lock is not activated.• Before the washing machine starts to fill, it will make a series of clicking noises to check the door lock and does a quick drain.• Was the door opened during the spinning cycle? Close the door, and press or tap Start/Pause to resume.• The machine enters Standby or is in a soaking cycle. Please wait.• Check the fuse or reset the circuit breaker
Water is not supplied.	<ul style="list-style-type: none">• Make sure you press or tap Start/Pause after selecting the water supply.• Make sure the water taps are open.• Is the filter net at the water supply hose connector clogged? Clean the filter net by brushing with a toothbrush.• Is the water supply cut off? If the water supply is cut off, close the tap and power off.• Straighten the water supply hoses.• Open and close the door, then press or tap Start/Pause.• If the water pressure is low, it takes longer to start washing.• If the water level is not as high as necessary or lower than expected, use the level selector to adjust the water level.
After a cycle, detergent remains in the automatic dispenser.	<ul style="list-style-type: none">• Make sure the washing machine is running with sufficient water pressure.• Make sure the detergent drawer is properly inserted.• Remove and clean the detergent drawer, and then try again.



Problem	Action
Vibrates excessively or makes noise.	<ul style="list-style-type: none">• Make sure the washing machine is set on a level floor. If the floor is not level, use the levelling feet to adjust the washing machine.• Make sure the washing machine is not contacting any other object.• Make sure the laundry load is balanced.• Make sure the laundry is spread evenly in the washing machine. Spread out the laundry evenly and start again.• Make sure the space around the washing machine is free of objects.• Humming is produced normally during operation.• Objects such as coins can cause noise. Remove these objects from the washing machine after washing is complete.
Stops.	<ul style="list-style-type: none">• Plug the power cord into a live electrical outlet.• Check the fuse or reset the circuit breaker.• Close the door, and press or tap Start/Pause to start the washing machine. For your safety, the washing machine will not spin unless the door is closed.• Before the washing machine starts to fill, it will make a series of clicking noises to check the door lock and does a quick drain.• There may be a pause or soak period in the cycle. Wait briefly and the washing machine may start.• Make sure the inlet hose screens at the taps are not clogged. Periodically clean the screens.• This problem occurs temporarily due to low voltages, and will be solved when power recovers.



Troubleshooting

Problem	Action
Fills with the wrong temperature water.	<ul style="list-style-type: none"> • Fully open both water taps. • Make sure the temperature selection is correct. • Make sure the hoses are connected to the correct water taps. Flush water lines. • Disconnect the hoses and clean the screens. The hose filter screens may be clogged. • While the washing machine fills, the water temperature may change as the automatic temperature control feature checks incoming water temperature. This is normal. • While the washing machine fills, you may notice just hot and/or just cold water going through the dispenser when cold or warm temperatures are selected. This is a normal function of the automatic temperature control feature as the washing machine determines the water temperature.
Door (Lid) locked or will not open.	<ul style="list-style-type: none"> • While the washing machine is operating, press or tap Start/Pause to stop the washing machine. • It may take a few moments for the door lock mechanism to disengage.
Does not drain and/or spin.	<ul style="list-style-type: none"> • Check the fuse or reset the circuit breaker. • Make sure the electrical voltage is normal. • Make sure the washing machine is plugged in. • Make sure the drain hose is pointed downward. (Natural drain models only) • Make sure the drain hose is not clogged. • Make sure the drain hose is not kinked. • Straighten the drain hose. If there is a drain restriction, call for service. • Close the door, and press or tap Start/Pause. For your safety, the washing machine will not spin unless the door is closed.
Load is wet at the end of the cycle.	<ul style="list-style-type: none"> • Use the High or Extra High spin speed. (Applicable model only) • Use high efficiency (HE) detergent to reduce oversudsing. • Load is too small. Small loads (one or two items) may become unbalanced and not spin completely.





Problem	Action
Leaks water.	<ul style="list-style-type: none">• Make sure all hose connections are tight.• Make sure the water supply hose's rubber packing is in the correct position. Screw tightly again.• Make sure the end of the drain hose is correctly inserted and secured to the drain system.• Avoid overloading.• Use high efficiency (HE) detergent to prevent oversudsing.• Make sure the water supply hose is not kinked.• If the water supply is too strong, water may leak. Close the water tap a little.• Make sure water is not leaking from the water tap. If so, repair the water tap.
Excessive suds.	<ul style="list-style-type: none">• Use high efficiency (HE) detergent to prevent oversudsing.• Reduce the detergent amount for soft water, small loads, or lightly soiled loads.• Non-HE detergent is not recommended.
The spin basket or drain/supply hose is frozen.	<ul style="list-style-type: none">• Use warm water to disconnect the water supply hose and drain hose. Soak them in warm water.• Fill the spin basket with warm water, and then wait for about 10 minutes.• Put a hot towel on the drain hose connector.• Reconnect the water supply hose and drain hose, and check if water is supplied properly.
Water drains out immediately.	<ul style="list-style-type: none">• Make sure the drain hose is not clogged, and is hung over the drain hose hook. Fill the spin basket halfway with water, and try spinning again.• Lift the end of the drain hose to prevent water from draining. Fill the spin basket halfway with water, and then run spinning after releasing the drain hose.• Make sure the drain hose is installed correctly. See the installation section of this user manual and adjust the position of the drain hose as instructed.
Stains on clothes.	<ul style="list-style-type: none">• Clean the magic filter.
Has odours.	<ul style="list-style-type: none">• Excessive suds collect in recesses and can cause foul odours.• Run cleansing cycles to sanitize periodically.• Dry the washing machine interior after a cycle has finished.

If a problem persists, contact a local Samsung service center.

Troubleshooting

Information codes

The washer may display information codes to help you understand what is occurring with your washer better.

No	Code	Meaning
1	1C	<p>The WaterLevel sensor is not working properly.</p> <ul style="list-style-type: none">• Check WaterLevel Sensor wire harness.• If the information code remains, contact a customer service centre. <p> NOTE</p> <p>When the washer displays “1C”, the washer do draining for 3 minutes. During this time, the Power button is inoperative.</p>
2	3C	<p>Check the motor for operation.</p> <ul style="list-style-type: none">• Try restarting the cycle.• If the problem continues, call for service.
3	4C	<p>Water is not supplied.</p> <ul style="list-style-type: none">• Make sure the water taps are open.• Make sure the water hoses are not clogged.• Make sure the water taps are not frozen.• Make sure the washing machine is operating with sufficient water pressure.• Make sure that the cold water tap and the hot water tap are properly connected.• Clean the mesh filter as it may be clogged. <p> NOTE</p> <p>When the washer displays “4C”, the washer do draining for 3 minutes. During this time, the Power button is inoperative.</p>
4	4C2	<ul style="list-style-type: none">• Make sure the cold water supply hose is firmly connected to the cold water tap. <p>If it is connected to the hot water tap, the laundry may be deformed with some cycles.</p>



No	Code	Meaning
5	5C	Water is not draining. <ul style="list-style-type: none">• Make sure the drain hose is not frozen or clogged.• Make sure the drain hose is positioned correctly, depending on the connection type.• Clean the debris filter as it may be clogged.• Make sure the drain hose is straightened all the way to the drain system.• If the information code remains, contact a customer service centre.
6	9C1	The electronic control needs to be checked (Over Voltage Error). <ul style="list-style-type: none">• Check the PCB and wire harness.• Check if power is supplied properly.• If the information code remains, contact a customer service centre.
7	9C2	Low voltage detected <ul style="list-style-type: none">• Check if the power cord is plugged in.• If the information code remains, contact a customer service centre.
8	AC6	Inverter Communication problem <ul style="list-style-type: none">• Check the Inverter PCB and wire harness.• If the information code remains, contact a customer service centre.
9	dC	Operating the washer with the door open. <ul style="list-style-type: none">• Make sure the door is properly closed.• Make sure laundry is not caught in the door.
10	HC	High temperature heating check. <ul style="list-style-type: none">• If the information code remains, contact a customer service centre.

Troubleshooting

No	Code	Meaning
11	LC	<p>Check the drain hose.</p> <ul style="list-style-type: none"> • Make sure the end of the drain hose is placed on the floor. • Make sure the drain hose is not clogged. • If the information code remains, contact a customer service centre. <p> NOTE</p> <p>When the washer displays “LC”, the washer do draining for 3 minutes. During this time, the Power button is inoperative.</p>
12	OC	<p>Water is overflowed.</p> <ul style="list-style-type: none"> • Restart after spinning. • If the information code remains on the display, contact a local Samsung service centre.
13	PC	<p>When position of the clutch can't be detected.</p> <ul style="list-style-type: none"> • If the information code remains, contact a customer service centre.
14	PC1	<p>After position of the clutch is detected, if the signal of the clutch hall goes wrong.</p> <ul style="list-style-type: none"> • If the information code remains, contact a customer service centre.
15	Ub	<p>Spinning does not work.</p> <ul style="list-style-type: none"> • Make sure laundry is spread out evenly. • Make sure the washing machine is on a flat, stable surface. • Redistribute the load. If only one item of clothing needs washing, such as a bathrobe or pair of jeans, the final spin result might be unsatisfactory, and an “Ub” check message will be shown in the display.
16	Ur	<p>Display for additional rinsing.</p> <ul style="list-style-type: none"> • Show additional rinsing in sensing unbalance. • Method of releasing the display. - Any key input.





For any codes not listed above, call 1-800-726-7864 (1-800-SAMSUNG).

Specifications

Fabric care chart

The following symbols provide garment care direction. The clothing care labels include symbols for drying, bleaching, drying and ironing, or dry cleaning when necessary. The use of symbols ensures consistency among garment manufacturers of domestic and imported items. Follow care label directions to optimize garment life and reduce laundering problems.

Wash cycle

	Normal
	Permanent press/Wrinkle resistant/Wrinkle control
	Gentle/Delicates
	Hand wash

Water temperature



...	Hot
..	Warm
.	Cold

NOTE



This represents appropriate wash water temperatures for various items. The temperature range for Hot is 105° - 125 °F / 41° - 52 °C, for Warm 85° - 105 °F / 29° - 41 °C and for Cold 60° - 85 °F / 16° - 29 °C. (Wash water temperature must be a minimum of 60 °F / 16 °C for detergent activation and effective cleaning.)

The clothes washer can not ensure these temperatures because the actual temperature of the water entering your washer depends on water heater settings and regional water supply temperatures. For example, cold water entering the home in the northern states during winter may be 40 °F / 4 °C which is too cold for effective cleaning. In this situation, you will need to adjust the water temperature by selecting a warm setting, adding some hot water to the MAX FILL line, or using your Washer's heating option, if available.



Bleach

	Any bleach (when needed)
	Only non-chlorine (color-safe) bleach (when needed)
	Tumble dry

Normal





	Permanent press/Wrinkle resistant/Wrinkle control
	Gentle/Delicates

Special instructions





	Line dry/Hang to dry
	Drip dry
	Dry flat

Specifications



Heat setting

	High
	Medium
	Low
	Any heat
	No heat / Air







Dry-clean

	Dry-clean
	Do not dry-clean
	Line dry / Hang to dry
	Drip dry
	Dry flat

Iron dry or steam temperatures

	High
	Medium
	Low

Warning symbols for laundering

	Do not wash
	Do not wring
	Do not bleach
	Do not tumble dry
	No steam (added to iron)
	Do not iron



Helping the environment

- Your washer is manufactured from recyclable materials. If you decide to dispose of it, please observe local waste disposal regulations. Cut off the power cord so that the appliance cannot be connected to a power source. Remove the lid so that animals and small children cannot get trapped inside the appliance.
- Do not exceed the detergent quantities recommended in the detergent manufacturers' instructions.
- Use stain removal products and bleaches before the wash cycle only when necessary.
- Save water and electricity by only washing full loads (the exact amount depends upon the program used).

Declaration of conformity

This appliance complies with UL2157.

Specifications

Specification sheet

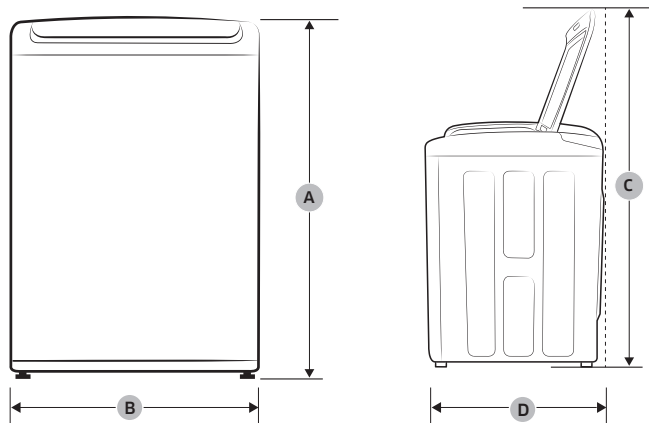

Type		Top loading washer	
Model name		WA52M8650A*	
Dimensions (inches (cm))	A. Height	42.4 (107.7)	
	B. Width	27.0 (68.6)	
	C. Height with lid open	61.0 (155.0)	
	D. Depth	29.3 (74.4)	
Water pressure (psi (kPa))		20 - 116 (137 - 800)	
Spin revolution		800 rpm	
NET weight (kg (lb))		62 (137.0)	
Heater rating	Washing	120 V	700 W
	Spin	120 V	400 W
	Drain	120 V	80 W

Cycle chart

Use this chart to set the best cycle and options for you laundry.

NOTE

Setting	Temp.	Spin	Soil Level
●: factory setting	H: Hot	H: High	H: Heavy
●: can be selected	W: Warm	M: Medium	N: Normal
	EW: Eco Warm	L: Low	L: Light
	CL: Cool	NS: No Spin	
	CD: Cold		

Cycle	Temp.					Spin				Soil Level		
	H	W	EW	CL	CD	H	M	L	NS	H	N	L
Normal	●	●	●	●	●	●	●		●	●	●	●
Heavy Duty	●	●	●	●	●	●	●	●	●	●	●	●
Super Speed	●	●	●	●	●	●	●	●	●	●	●	●
Deep Wash	●	●	●	●	●	●	●	●	●	●	●	●
Delicates		●	●	●	●		●	●	●			●
Brilliant Whites	●	●	●	●	●	●	●	●	●	●	●	●
Bedding/ WaterProof	●	●	●	●	●	●	●	●	●	●	●	●
Perm Press	●	●	●	●	●	●	●	●	●	●	●	●
Quick Wash	●	●	●	●	●	●	●	●	●	●	●	●
Active Wear		●	●	●	●	●	●	●	●		●	●
Rinse+Spin						●	●	●	●			
Spin						●	●	●	●			
Self Clean	●						●					

Specifications

Cycle	Options		
	Pre Soak	Extra Rinse	Eco Plus
Normal	●	●	●
Heavy Duty	●	●	●
Super Speed		●	
Deep Wash	●	●	●
Delicates		●	
Brilliant Whites	●	●	●
Bedding/ WaterProof	●	●	
Perm Press	●	●	●
Quick Wash		●	
Active Wear	●	●	●
Rinse+Spin		●	
Spin			
Self Clean			



Warranty (U.S.A)

SAMSUNG WASHER

LIMITED WARRANTY TO ORIGINAL PURCHASER

This SAMSUNG brand product, as supplied and distributed by SAMSUNG ELECTRONICS AMERICA, INC. (SAMSUNG) and delivered new, in the original carton to the original consumer purchaser, is warranted by SAMSUNG against manufacturing defects in materials and workmanship for a limited warranty period of:

One (1) year part and labor, Three (3) years stainless tub part (Part Only), Ten (10) years washing DD motor part (Part Only).

This limited warranty begins on the original date of purchase, and is valid only on products purchased and used in the United States. To receive warranty service, the purchaser must contact SAMSUNG for problem determination and service procedures. Warranty service can only be performed by a SAMSUNG authorized service center. The original dated bill of sale must be presented upon request as proof of purchase to SAMSUNG or SAMSUNG's authorized service center. SAMSUNG will provide in-home service during the warranty period at no charge, subject to availability within the contiguous United States. In-home service is not available in all areas.

To receive in-home service, product must be unobstructed and accessible to the service agent. If service is not available, SAMSUNG may elect to provide transportation of the product to and from an authorized service center.

SAMSUNG will repair, replace, or refund this product at our option and at no charge as stipulated herein, with new or reconditioned parts or products if found to be defective during the limited warranty period specified above. All replaced parts and products become the property of SAMSUNG and must be returned to SAMSUNG. Replacement parts and products assume the remaining original warranty, or ninety (90) days, whichever is longer. This limited warranty covers manufacturing defects in materials and workmanship encountered in normal, noncommercial use of this product and shall not apply to the following: damage that occurs in shipment; delivery and installation; applications and uses for which this product was not intended; altered product or serial numbers; cosmetic damage or exterior finish; accidents, abuse, neglect, fire, water, lightning, or other acts of nature or God; use of products, equipment, systems, utilities, services, parts, supplies, accessories, applications, installations, repairs, external wiring or connectors not supplied or authorized by SAMSUNG that damage this product or result in service problems; incorrect electrical line voltage, fluctuations and surges; customer adjustments and failure to follow operating instructions, maintenance and environmental instructions that are covered and prescribed in the instruction book; product removal and reinstallation; problems caused by pest infestations.



Warranty (U.S.A)

This limited warranty does not cover problems resulting from incorrect electric current, voltage or supply, light bulbs, house fuses, house wiring, cost of a service call for instructions, or fixing installation errors. SAMSUNG does not warrant uninterrupted or error-free operation of the product.

EXCEPT AS SET FORTH HEREIN, THERE ARE NO WARRANTIES ON THIS PRODUCT EITHER EXPRESS OR IMPLIED, AND SAMSUNG DISCLAIMS ALL WARRANTIES INCLUDING, BUT NOT LIMITED TO, ANY IMPLIED WARRANTIES OF MERCHANTABILITY, INFRINGEMENT OR FITNESS FOR A PARTICULAR PURPOSE.

NO WARRANTY OR GUARANTEE GIVEN BY ANY PERSON, FIRM, OR CORPORATION WITH RESPECT TO THIS PRODUCT SHALL BE BINDING ON SAMSUNG. SAMSUNG SHALL NOT BE LIABLE FOR LOSS OF REVENUE OR PROFITS, FAILURE TO REALIZE SAVINGS OR OTHER BENEFITS, OR ANY OTHER SPECIAL, INCIDENTAL OR CONSEQUENTIAL DAMAGES CAUSED BY THE USE, MISUSE, OR INABILITY TO USE THIS PRODUCT, REGARDLESS OF THE LEGAL THEORY ON WHICH THE CLAIM IS BASED, AND EVEN IF SAMSUNG HAS BEEN ADVISED OF THE POSSIBILITY OF SUCH DAMAGES.

NOR SHALL RECOVERY OF ANY KIND AGAINST SAMSUNG BE GREATER IN AMOUNT THAN THE PURCHASE PRICE OF THE PRODUCT SOLD BY SAMSUNG AND CAUSING THE ALLEGED DAMAGE.

WITHOUT LIMITING THE FOREGOING, PURCHASER ASSUMES ALL RISK AND LIABILITY FOR LOSS, DAMAGE, OR INJURY TO PURCHASER AND PURCHASER'S PROPERTY AND TO OTHERS AND THEIR PROPERTY ARISING OUT OF THE USE, MISUSE, OR INABILITY TO USE THIS PRODUCT. THIS LIMITED WARRANTY SHALL NOT EXTEND TO ANYONE OTHER THAN THE ORIGINAL PURCHASER OF THIS PRODUCT, IS NONTRANSFERABLE AND STATES YOUR EXCLUSIVE REMEDY.

Some states do not allow limitations on how long an implied warranty lasts, or the exclusion or limitation of incidental or consequential damages, so the above limitations or exclusions may not apply to you. This warranty gives you specific rights, and you may also have other rights, which vary from state to state.



To obtain warranty service, please contact SAMSUNG at:
Samsung Electronics America, Inc.
85 Challenger Road
Ridgefield Park, NJ 07660
1-800-SAMSUNG (726-7864)
www.samsung.com/us/support

Visits by a Service Engineer to explain functions, maintenance or installation is not covered by warranty.
Please contact your Samsung call agent for help with any of these issues.





Warranty (CANADA)

SAMSUNG WASHER

LIMITED WARRANTY TO ORIGINAL PURCHASER

This SAMSUNG brand product, as supplied and distributed by SAMSUNG ELECTRONICS CANADA, INC. (SAMSUNG) and delivered new, in the original carton to the original consumer purchaser, is warranted by SAMSUNG against manufacturing defects in materials and workmanship for a limited warranty period of:

One (1) year part and labor, Ten (10) years washing DD motor (Part only).

This limited warranty begins on the original date of purchase, and is valid only on products purchased and used in the Canada. To receive warranty service, the purchaser must contact SAMSUNG for problem determination and service procedures. Warranty service can only be performed by a SAMSUNG authorized service center. The original dated bill of sale must be presented upon request as proof of purchase to SAMSUNG or SAMSUNG's authorized service center. SAMSUNG will provide in-home service during the warranty period at no charge, subject to availability within the Canada. In-home service is not available in all areas.

To receive in-home service, product must be unobstructed and accessible to the service agent. If service is not available, SAMSUNG may elect to provide transportation of the product to and from an authorized service center.

SAMSUNG will repair, replace, or refund this product at our option and at no charge as stipulated herein, with new or reconditioned parts or products if found to be defective during the limited warranty period specified above. All replaced parts and products become the property of SAMSUNG and must be returned to SAMSUNG. Replacement parts and products assume the remaining original warranty, or ninety (90) days, whichever is longer. This limited warranty covers manufacturing defects in materials and workmanship encountered in normal, noncommercial use of this product and shall not apply to the following: damage that occurs in shipment; delivery and installation; applications and uses for which this product was not intended; altered product or serial numbers; cosmetic damage or exterior finish; accidents, abuse, neglect, fire, water, lightning, or other acts of nature or God; use of products, equipment, systems, utilities, services, parts, supplies, accessories, applications, installations, repairs, external wiring or connectors not supplied or authorized by SAMSUNG that damage this product or result in service problems; incorrect electrical line voltage, fluctuations and surges; customer adjustments and failure to follow operating instructions, maintenance and environmental instructions that are covered and prescribed in the instruction book; product removal and reinstallation; problems caused by pest infestations.



This limited warranty does not cover problems resulting from incorrect electric current, voltage or supply, light bulbs, house fuses, house wiring, cost of a service call for instructions, or fixing installation errors. SAMSUNG does not warrant uninterrupted or error-free operation of the product.

EXCEPT AS SET FORTH HEREIN, THERE ARE NO WARRANTIES ON THIS PRODUCT EITHER EXPRESS OR IMPLIED, AND SAMSUNG DISCLAIMS ALL WARRANTIES INCLUDING, BUT NOT LIMITED TO, ANY IMPLIED WARRANTIES OF MERCHANTABILITY, INFRINGEMENT OR FITNESS FOR A PARTICULAR PURPOSE.

NO WARRANTY OR GUARANTEE GIVEN BY ANY PERSON, FIRM, OR CORPORATION WITH RESPECT TO THIS PRODUCT SHALL BE BINDING ON SAMSUNG. SAMSUNG SHALL NOT BE LIABLE FOR LOSS OF REVENUE OR PROFITS, FAILURE TO REALIZE SAVINGS OR OTHER BENEFITS, OR ANY OTHER SPECIAL, INCIDENTAL OR CONSEQUENTIAL DAMAGES CAUSED BY THE USE, MISUSE, OR INABILITY TO USE THIS PRODUCT, REGARDLESS OF THE LEGAL THEORY ON WHICH THE CLAIM IS BASED, AND EVEN IF SAMSUNG HAS BEEN ADVISED OF THE POSSIBILITY OF SUCH DAMAGES.

NOR SHALL RECOVERY OF ANY KIND AGAINST SAMSUNG BE GREATER IN AMOUNT THAN THE PURCHASE PRICE OF THE PRODUCT SOLD BY SAMSUNG AND CAUSING THE ALLEGED DAMAGE. WITHOUT LIMITING THE FOREGOING, PURCHASER ASSUMES ALL RISK AND LIABILITY FOR LOSS, DAMAGE, OR INJURY TO PURCHASER AND PURCHASER'S PROPERTY AND TO OTHERS AND THEIR PROPERTY ARISING OUT OF THE USE, MISUSE, OR INABILITY TO USE THIS PRODUCT. THIS LIMITED WARRANTY SHALL NOT EXTEND TO ANYONE OTHER THAN THE ORIGINAL PURCHASER OF THIS PRODUCT, IS NONTRANSFERABLE AND STATES YOUR EXCLUSIVE REMEDY.

Some provinces do not allow limitations on how long an implied warranty lasts, or the exclusion or limitation of incidental or consequential damages, so the above limitations or exclusions may not apply to you. This warranty gives you specific rights, and you may also have other rights, which vary from province to province.



Warranty (CANADA)

To obtain warranty service, please contact SAMSUNG at:
Samsung Electronics Canada Inc.
2050 Derry Road West
Mississauga, Ontario L5N 0B9 Canada
1-800-SAMSUNG (726-7864)
www.samsung.com/ca/support (English)
www.samsung.com/ca_fr/support (French)

Visits by a Service Engineer to explain functions, maintenance or installation is not covered by warranty.
Please contact your Samsung call agent for help with any of these issues.



Memo



SAMSUNG



Scan the QR code* or visit
www.samsung.com/spsn
to view our helpful
How-to Videos and Live Shows

*Requires reader to be installed on your smartphone

Scan this with your smartphone

QUESTIONS OR COMMENTS?

COUNTRY	CALL	OR VISIT US ONLINE AT
U.S.A	1-800-SAMSUNG (726-7864)	www.samsung.com/us/support
CANADA	1-800-SAMSUNG (726-7864)	www.samsung.com/ca/support (English) www.samsung.com/ca_fr/support (French)



DC68-03774C-01_EN