

Typhur

# Typhur Sync Gold Dual

User Manual

US Version

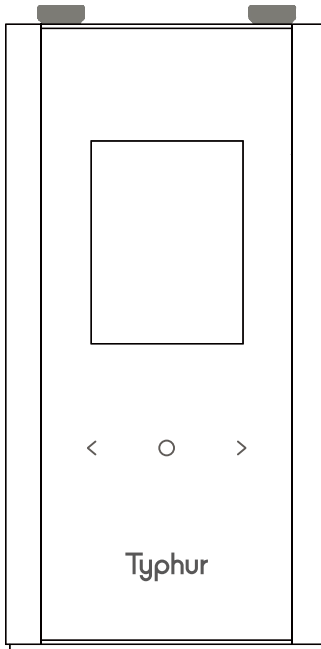

v1.0

2024.05

Scan the QR code to download  
the latest user manual



## Important Safeguards

Please read this entire manual before using your Typhur Sync Gold Dual. Failure to follow these instructions could result in property damage or bodily injury.

### CAUTION

- 1 **DO NOT** use the Probe when cooking at temperatures above 932°F/500°C for 2 minutes.
- 2 **DO NOT** place the Device Base unit directly on the grill cover or close to any hot surface.
- 3 **DO NOT** use the Probe in a microwave or pressure cooker.
- 4 **DO NOT** use cleaning products containing alcohol, ammonium, benzene, or abrasives, all of which could damage the device.
- 5 **DO NOT** submerge the Probe in water for long periods of time.
- 6 **DO NOT** run the Probe under cold water immediately after cooking. Let the probe cool down prior to washing.
- 7 The Device Base is **NOT** waterproof and should not be submerged in water or placed in the dishwasher. The probe is SHARP! Care should be exercised when handling the probe. This appliance should **NOT** be used by or near children under 8 years old or individuals with certain disabilities. Children shall **NOT** play with the appliance. Cleaning and user maintenance shall **NOT** be made by children without supervision.

- 8** If the Probe falls into a fire or direct heat source, turn off the cooking appliance and close the lid immediately. Allow the Probe to cool completely before removing.
- 9** Carefully remove the Probe from the cooked meat, taking caution as it may be hot.
- 10** The Device Base shall only be supplied with safety extra-low voltage (SELV) corresponding to the marking on the appliance.

## SAVE THESE INSTRUCTIONS

## Diagram

- Probe 1

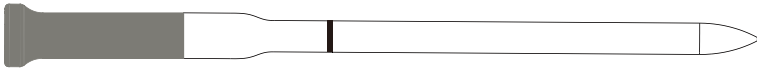

- Probe 2

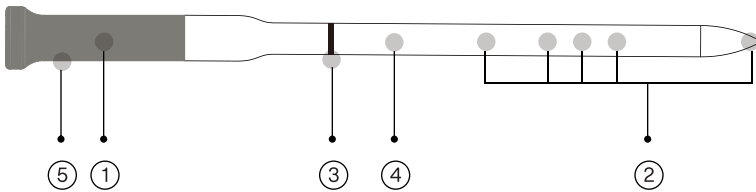

- 1 **Ambient Temperature Sensor** (Ambient Max 932°F / 500°C)
- 2 **Internal Temperature Sensor 1 - 5** (Internal Max 221°F / 105 °C)
- 3 **Safety Line**
- 4 **Stainless Steel**
- 5 **High-density Ceramic Handle**

## Diagram

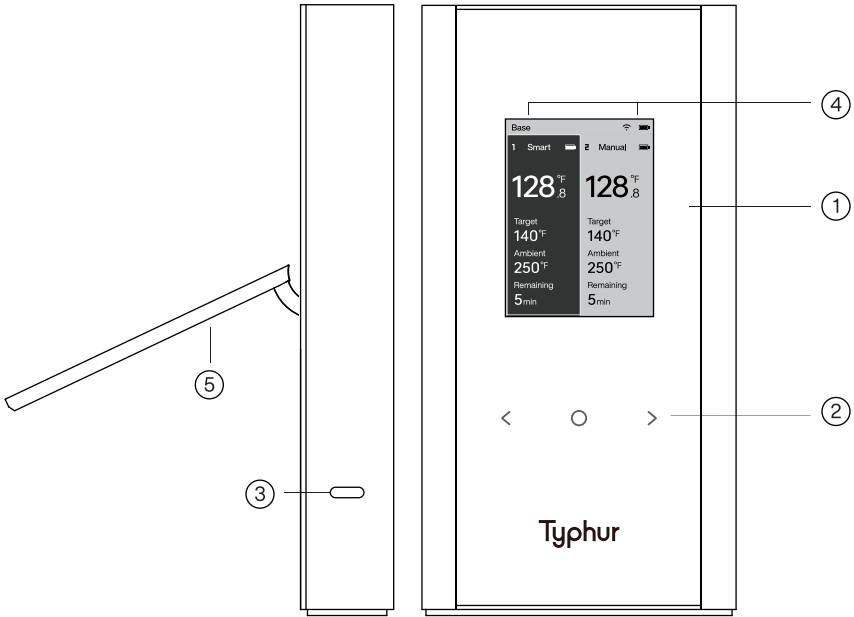

- 1 2.4" TFT Screen
- 2 Touch Capacitive Control
- 3 Type-C USB (5V 1400mA minimum required)
- 4 Probe Icon (Identify each Probe through the number)
- 5 Stand

## Specifications

### Probe:

---

Number of Temperature Sensors	6 (5 Internal and 1 Ambient)
Temperature Range	Internal 32°F - 221°F / 0°C-105°C Ambient 32°F-932°F / 0°C-500°C
Accuracy	Internal $\pm 0.5^{\circ}\text{F}/0.3^{\circ}\text{C}$
Dimensions	5.08 × 0.22 inches
Water Resistance	IPX8
Probe Material	Stainless Steel + Ceramic

---

\*This appliance contains non-replaceable batteries.

## Specifications

### Device Base:

---

Display	2.4" TFT LCD
---------	--------------

---

Dimensions	6.0 × 3.1 × 0.9 inches
------------	------------------------

---

Water Resistance	IPX2
------------------	------

---

Connection	Bluetooth/Wi-Fi (device only supports 2.4 GHz Wi-Fi)/Sub 1G
------------	---

---

Sleep Mode	Device will automatically enter default Sleep Mode after 5 minutes if the Probe is removed
------------	--

---

\*This appliance contains non-replaceable batteries.

## Using for the First Time:

- 1 Before using your Typhur Sync Gold Dual, ensure the product is fully charged and you have reviewed the important safety information.
- 2 Download the free Typhur App for iOS or Android.



- 3 Insert the probe completely into the meat, ensuring that it passes the safety line but does not exceed the ceramic handle and that the internal sensors are in the center of the meat.

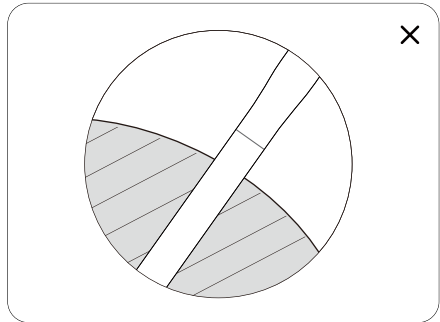
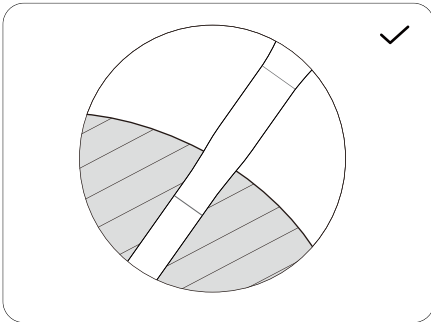

## Operation:

### Panel Instructions

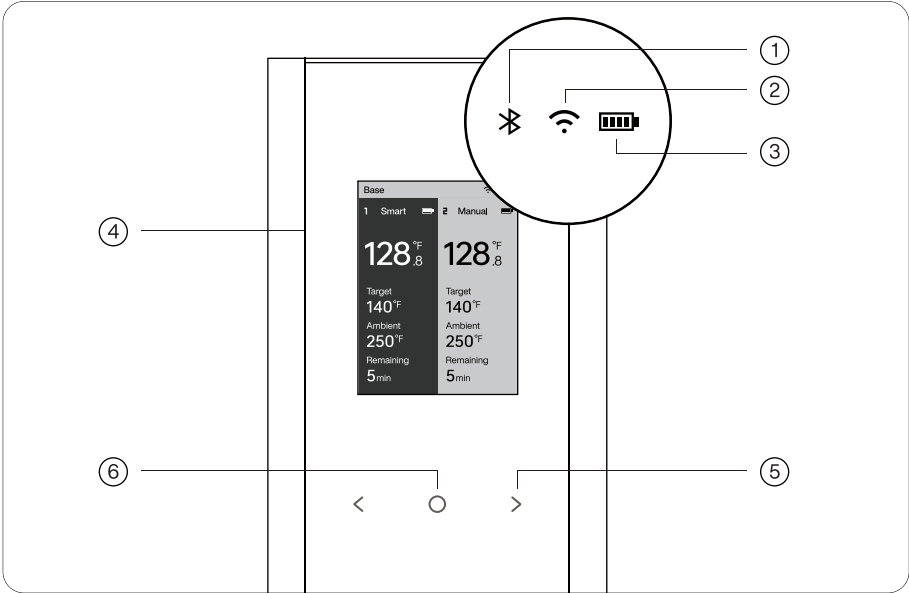

#### 1 Bluetooth Indicator

#### 2 Wi-Fi Indicator

#### 3 Battery Indicator

Rechargeable  
Device Base

#### 4 Probe Interface

Display the battery status of the Probe,  
temperature, and remaining time

#### 5 Left/Right Button

Select an item

#### 6 Power/Confirm Button

Turn the Device Base ON or OFF; execute the  
selected command

## Power Control

### Power On:

To power on the Device Base, press the "O" button for 3 seconds. The Device Base will activate and the buttons will illuminate.

### Power Off:

Press and hold the "O" button for 3 seconds to shut down the screen. When cooking, select "Stop" on the screen prompt of "Stop the Current Cooking" to power off the Device Base. The Probe will automatically power off after 5 minutes of being plugged into the Device Base.

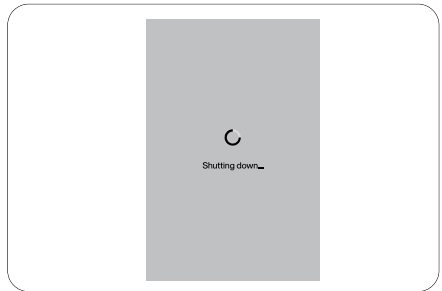
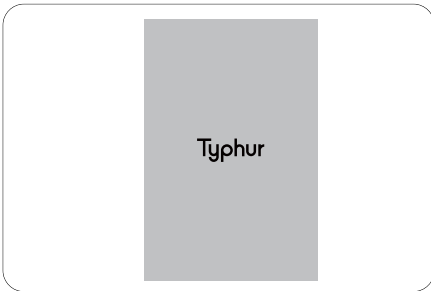

### Sleep Mode:

The Device Base automatically enters default Sleep Mode after 5 minutes of Probe inactivity. The default Sleep Mode time can be changed via the Typhur App.

When in Sleep Mode, the display turns off, the "<" and ">" buttons cease to illuminate, and the "O" button emits a pulsing light.

### Screen Lock Mode:

The screen will enter locked mode after 30 seconds of inactivity on the main page. To unlock the screen, simply touch any key. The screen will then return to its previous state.

## Select language

Press the "O" button to select the language.



## Pair the Typhur App

For first-time use, you can scan the QR code on the Device Base to download and install Typhur APP.



Open the Typhur App on your smartphone or tablet.

Tap on "Devices" and select "Add Device". Select Typhur Sync Gold Dual and follow the instructions to pair your device.

## Connectivity

### Wi-Fi connection (highly recommended)

The device will actively connect to Wi-Fi when within range of a Wi-Fi signal. This ensures that the Typhur App instantly receives any messages from the Device Base. The device will display the signal strength of the currently connected Wi-Fi network through the "Wi-Fi" icon.

### Bluetooth connection

The device can also connect to and push messages to the Typhur App via Bluetooth. However, this connection method does not guarantee that the app will receive all messages instantaneously. Please note that the Wi-Fi connection is more reliable than the Bluetooth connection.

## Restore Factory Settings

Press “<” and “>” simultaneously for 5 seconds to enter the “Reset” mode. Follow the prompts to complete the operation.

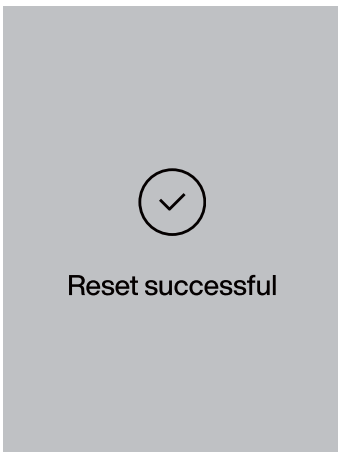
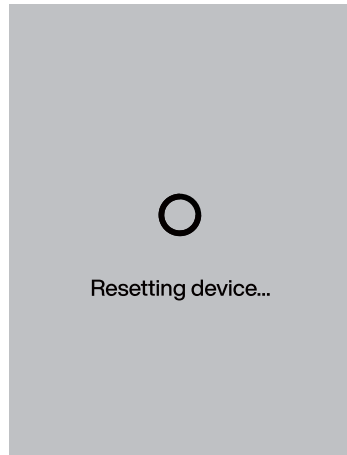
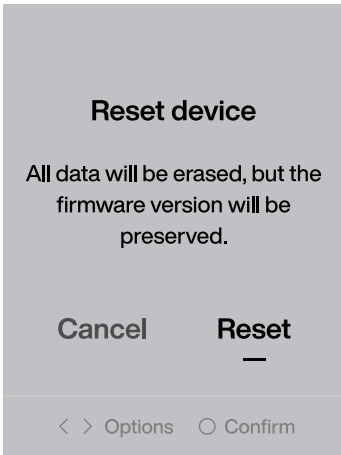

## Cooking

### Temperature Setting

Unplug either Probe to be used, and the Device Base's screen will display the "Set up cook" prompt. You can adjust your temperature unit preference via the Typhur App.

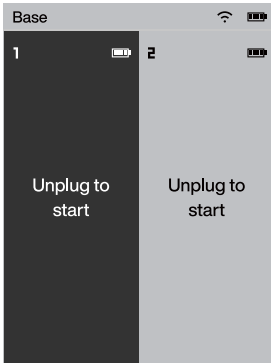

### Smart Mode

Smart Mode will predict when the meat should be removed from the heat source, based on its target temperature and the rate of warming. You will be alerted when the meat is both removed from the heat and when it is ready to serve.

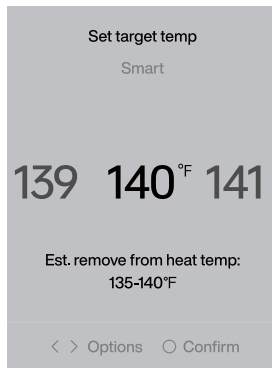
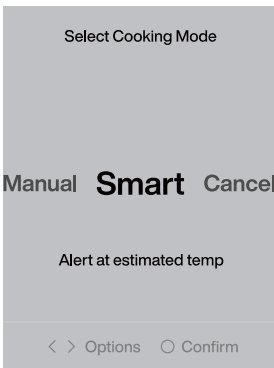

## Manual Mode

Receive alerts only when the temperature reaches the set temperature.

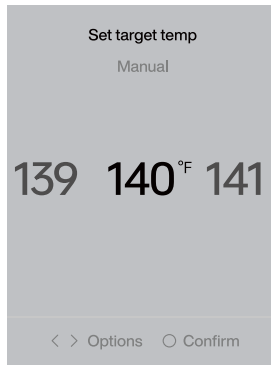
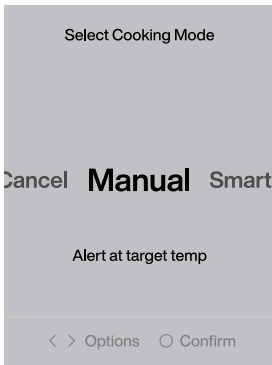

## Cooking States

### Remove from heat:

This state indicates that the food should be removed from the heat source.



# Typhur Sync Gold Dual User Manual

---

## Resting:

The food has entered a resting state, allowing the residual heat to continue to rise.



## Ready:

The food is cooked and ready to be served. Click "O" button to end the cooking process.

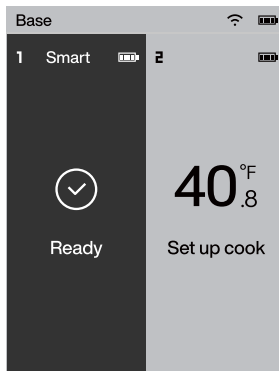

## Troubleshootings

Device Base Prompt	Possible Cause	Solution
"Probe Battery Low"	The Probe's battery power is at a low level.	Plug the Probe into the Device Base to charge it.
"Device Battery Low"	The Device Base's battery power is at a low level.	Use the included Type-C USB cable to charge the Device Base.
"Overheating"	The Probe has been exposed to an overheated environment.	Remove the Probe from the heat source and allow it to cool down before using it again.
"Error 403"	There may be a software, hardware, sensor, or communication failure.	Contact our customer support team for assistance. They will be able to help you diagnose and resolve the issue.

## Certifications:



Contains FCC ID: 2BEFM-WT1000R

Contains IC: 31884-WT1000R

FCC ID: 2BEFM-WTP3000

IC: 31884-WTP3000

### For Europe:

Frequency band of operation is 2400 to 2483.5 MHz. Maximum transmit power less than 20 dBm EIRP.

[Typhur Inc.] hereby declares that the radio equipment type [WT05] is in compliance with Directive 2014/53/EU. The full text of the EU declaration of conformity is available at the following Internet address: <https://explore.typhur.com/ce-declaration>.

## FCC Statement:

This device complies with part 15 of the FCC Rules. Operation is subject to the following two conditions:

1. This device may not cause harmful interference.
2. This device must accept any interference received, including interference that may cause undesired operation.

This equipment has been tested and found to comply with the limits for a Class B digital device, pursuant to part 15 of the FCC Rules. These limits are designed to provide reasonable protection against harmful interference in a residential installation. This equipment generates uses and can radiate radio frequency energy and, if not installed and used in accordance with the instructions, may cause harmful interference to radio communications. However, there is no guarantee that interference will not occur in a particular installation. If this equipment does cause harmful interference to radio or television reception, which can be determined by turning the equipment off and on, the user is encouraged to try to correct the interference by one or more of the following measures:

- Reorient or relocate the receiving antenna.
- Increase the separation between the equipment and receiver.
- Connect the equipment into an outlet on a circuit different from that to which the receiver is connected.
- Consult the dealer or an experienced radio/TV technician for help.

**CAUTION:** The user is cautioned that changes or modifications not expressly approved by the party responsible for compliance could void the user's authority to operate the equipment.

## FCC Radiation Exposure Statement:

The device complies with RF specifications when used near your body at a distance of 10 mm. Ensure that the device accessories, such as a device case and device holster, are not composed of metal components. Keep the device away from your body to meet the distance requirement.

## FCC Supplier's Declaration of Conformity

Product Name: Typhur Sync Gold Dual Wireless Thermometer  
Model number: WT05  
Suppliers Name: Typhur Inc.  
Suppliers Address (USA): 2890 Zanker Rd, Sulte 120, San Jose, CA 95134  
Suppliers contact mail: allen.f@typhur.com

## ISED Statement

This device contains licence-exempt transmitter(s)/receiver(s) that comply with Innovation, Science and Economic Development Canada's licence-exempt RSS(s). Operation is subject to the following two conditions:

1. This device may not cause interference.
2. This device must accept any interference, including interference that may cause undesired operation of the device. This equipment complies with Industry Canada radiation exposure limits set forth for an uncontrolled environment.

## ISED Radiation Exposure Statement

The device complies with RF specifications when used near your body at a distance of 10 mm. Ensure that the device accessories, such as a device case and device holster, are not composed of metal components. Keep the device away from your body to meet the distance requirement.



This symbol, affixed to the product or its packaging, indicates that the product must not be processed with household waste. It must be brought to an electric or electronic waste collection point for recycling and disposal. By ensuring the appropriate disposal of this product you also help in preventing potentially negative consequences for the environment and human health. The recycling of materials helps preserve our natural resources. For further information regarding the recycling of this product, please contact your municipality, local waste disposal center, or the store where the product was purchased.

## Support

Please contact our Customer Support Team if you have any questions.

1(888) 838-6563 (USA)

[support@typhur.com](mailto:support@typhur.com)

[www.typhur.com/contact-us](http://www.typhur.com/contact-us)

## Typhur Privacy Statement

We value your privacy and personal data rights, and we, Typhur Inc. are the entity responsible for the collection, use, and disclosure of information under our Privacy Statement. For more details, please visit <https://www.typhur.com/privacy-statement>

## Terms of Service

For details about Typhur Terms of Service, please visit <https://www.typhur.com/terms-of-service>

## Refund & Return Policy

Typhur has a 30-calendar day hassle-free return policy. For more details please visit <https://www.typhur.com/refund-and-return>

## Warranty

Full details are stated in Typhur's warranty policy at <https://www.typhur.com/warranty>