

Panasonic®

Operating Instructions Home Theater Audio System

Model No. SC-HTB700

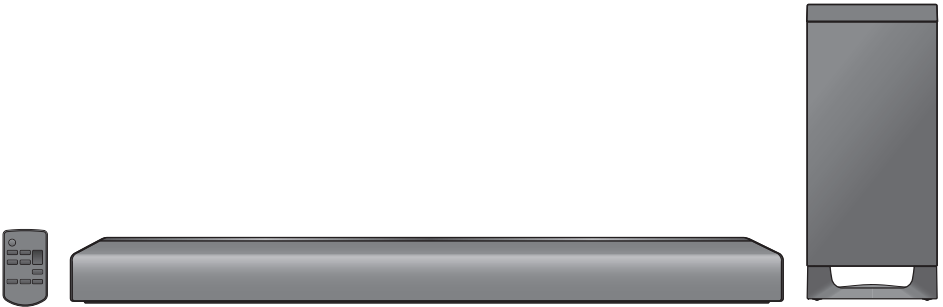

Thank you for purchasing this product.
Please read these instructions carefully before using this product,
and save this manual for future use.

Included Installation Instructions

The installation work should be done by a qualified installation specialist. (⇒ 12 to 15)

Before commencing work, carefully read these installation instructions and the operating instructions to ensure that installation is performed correctly.

(Please keep these instructions. You may need them when maintaining or moving this system.)

Model number suffix “EB” denotes UK model.

EB EG GN GW

TQBM0483

CAUTION

Safety precautions

WARNING

Unit

- To reduce the risk of fire, electric shock or product damage,
 - Do not expose this unit to rain, moisture, dripping or splashing.
 - Do not place objects filled with liquids, such as vases, on this unit.
 - Use the recommended accessories.
 - Do not remove covers.
 - Do not repair this unit by yourself. Refer servicing to qualified service personnel.
- To prevent injury, this apparatus must be securely attached to the wall in accordance with the installation instructions.

AC mains lead

- To reduce the risk of fire, electric shock or product damage,
 - Ensure that the power supply voltage corresponds to the voltage printed on this unit.
 - Insert the mains plug fully into the socket outlet.
 - Do not pull, bend, or place heavy items on the lead.
 - Do not handle the plug with wet hands.
 - Hold onto the mains plug body when disconnecting the plug.
 - Do not use a damaged mains plug or socket outlet.
- The mains plug is the disconnecting device. Install this unit so that the mains plug can be unplugged from the socket outlet immediately.

Button-type battery (Lithium battery)

- Risk of fire, explosion and burns. Do not recharge, disassemble, heat above 60 °C or incinerate.



WARNING

DO NOT INGEST BATTERY,
CHEMICAL BURN HAZARD

This product contains a coin/button cell battery. If the coin/button cell battery is swallowed, it can cause severe internal burns in just 2 hours and can lead to death. Keep new and used batteries away from children. If the battery compartment does not close securely, stop using the product and keep it away from children. If you think batteries might have been swallowed or placed inside any part of the body, seek immediate medical attention.

Small object

- Keep the adhesive tape of the IR Blaster and the screws out of reach of children to prevent swallowing.

Unit

- Do not place sources of naked flames, such as lighted candles, on this unit.
- This unit may receive radio interference caused by mobile telephones during use. If such interference occurs, please increase separation between this unit and the mobile telephone.
- This unit is intended for use in moderate climates.
- Product Identification Marking is located on the bottom of the unit.

Placement

- Place this unit on an even surface.
- To reduce the risk of fire, electric shock or product damage,
 - Do not install or place this unit in a bookcase, built-in cabinet or in another confined space. Ensure this unit is well ventilated.
 - Do not obstruct this unit's ventilation openings with newspapers, tablecloths, curtains, and similar items. Do not block the top of the main unit and the rear of the active subwoofer. (⇒ 5, 6)
 - Do not expose this unit to direct sunlight, high temperatures, high humidity, and excessive vibration.

Button-type battery (Lithium battery)

- Danger of explosion if battery is incorrectly replaced. Replace only with the type recommended by the manufacturer.
- Insert with poles aligned.
- Mishandling of batteries can cause electrolyte leakage and may cause a fire.
 - Remove the battery if you do not intend to use the remote control for a long period of time. Store in a cool, dark place.
 - Do not heat or expose to flame.
 - Do not leave the battery(ies) in a car exposed to direct sunlight for a long period of time with doors and windows closed.
- When disposing of the batteries, please contact your local authorities or dealer and ask for the correct method of disposal.

Disposal of Old Equipment and Batteries Only for European Union and countries with recycling systems



These symbols on the products, packaging, and/or accompanying documents mean that used electrical and electronic products and batteries must not be mixed with general household waste. For proper treatment, recovery and recycling of old products and used batteries, please take them to applicable collection points in accordance with your national legislation. By disposing of them correctly, you will help to save valuable resources and prevent any potential negative effects on human health and the environment. For more information about collection and recycling, please contact your local municipality. Penalties may be applicable for incorrect disposal of this waste, in accordance with national legislation.



(Note for the battery symbol (bottom symbol)): This symbol might be used in combination with a chemical symbol. In this case it complies with the requirement set by the Directive for the chemical involved.

Caution for AC Mains Lead



(For the AC mains plug of three pins)

For your safety, please read the following text carefully.

This appliance is supplied with a moulded three pin mains plug for your safety and convenience.

A 5-ampere fuse is fitted in this plug.

Should the fuse need to be replaced please ensure that the replacement fuse has a rating of 5-ampere and that it is approved by ASTA or BSI to BS1362.

Check for the ASTA mark  or the BSI mark  on the body of the fuse.

If the plug contains a removable fuse cover you must ensure that it is refitted when the fuse is replaced.

If you lose the fuse cover the plug must not be used until a replacement cover is obtained.

A replacement fuse cover can be purchased from your local dealer.

Before use

Remove the connector cover.

How to replace the fuse

The location of the fuse differ according to the type of AC mains plug (figures A and B). Confirm the AC mains plug fitted and follow the instructions below.

Illustrations may differ from actual AC mains plug.

1. Open the fuse cover with a screwdriver.

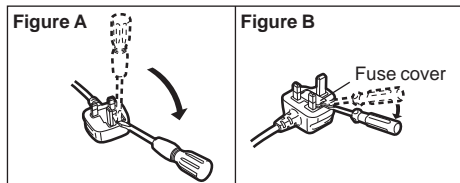

2. Replace the fuse and close or attach the fuse cover.

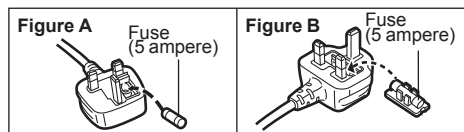

About Bluetooth®

Panasonic bears no responsibility for data and/or information that is compromised during a wireless transmission.

■ Frequency band used

This system uses the 2.4 GHz frequency band.

■ Certification of this device

- This system conforms to frequency restrictions and has received certification based on frequency laws. Thus, a wireless permit is not necessary.
- The action below are punishable by law in some countries:
 - Taking apart or modifying the unit.
 - Removing specification indications.

■ Restrictions of use

- Wireless transmission and/or usage with all Bluetooth® equipped devices is not guaranteed.
- All devices must conform to standards set by Bluetooth SIG, Inc.
- Depending on the specifications and settings of a device, it can fail to connect or some operations can be different.
- This system supports Bluetooth® security features. But depending on the operating environment and/or settings, this security is possibly not sufficient. Transmit data wirelessly to this system with caution.
- This system cannot transmit data to a Bluetooth® device.

■ Range of use

Use this device at a maximum range of 10 m. The range can decrease depending on the environment, obstacles or interference.

■ Interference from other devices

- This system may not function properly and troubles such as noise and sound jumps may arise due to radio wave interference if the main unit is located too close to other Bluetooth® devices or the devices that use the 2.4 GHz band.
- This system may not function properly if radio waves from a nearby broadcasting station, etc. are too strong.

■ Intended usage

- This system is for normal, general use only.
- Do not use this system near equipment or in an environment that is sensitive to radio frequency interference (example: airports, hospitals, laboratories, etc.).

Table of contents

Safety precautions	2
About Bluetooth®	3
Supplied items.....	4

Before use

Control reference guide.....	5
------------------------------	---

Getting started

Step 1 Connections.....	8
Step 2 Placement.....	12
Step 3 Active subwoofer wireless connection	16

Operations

Using this system.....	17
Bluetooth® operations	18
Sound menu.....	19
Setup menu.....	20
Linked operations with the TV (VIERA Link “HDAVI Control™”)	22

Reference

Troubleshooting	24
Unit care	29
Licenses	29
Specifications	30

Supplied items

This system (SC-HTB700)

- 1 Main unit (speaker) (⇒ 5) (SU-HTB700)
- 1 Active subwoofer (⇒ 5) (SB-HWA900)

Accessories

Check the supplied accessories before using this system.

- 1 Remote control (with a battery) (⇒ 7) (N2QAYC000121)
- 1 IR Blaster (⇒ 10) (K2ZZ02C00007)
- 2 Wall mount brackets (⇒ 14) (TUWX2111)
- 2 AC mains lead (⇒ 11)
For the United Kingdom and Ireland (K2CT2YY00089)
For Continental Europe (K2CQ2YY00164)
For Australia and New Zealand (K2CJ2YY00123)
For India (K2CP2YY00070)
- 2 Screws (⇒ 14) (XYN5+J14FJK)



- Product numbers are correct as of June 2019. These may be subject to change.
- The supplied AC mains lead is for use with this system only.
Do not use it with other equipment. Also, do not use cords from other equipment with this system.

About descriptions in these operating instructions

- Pages to be referred to are indicated as “⇒ ○○”.
- Labels on this unit and the remote control are indicated as [○○] in these operating instructions.
- The illustrations shown may differ from your unit.
- These operating instructions are applicable to model SC-HTB700 for variety of regions. Unless otherwise indicated, illustrations in these operating instructions are of the model for the United Kingdom and Ireland.
- Operations in this operating instructions are described mainly with the remote control, but you can perform the operations on the main unit if the controls are the same.

Control reference guide

This system (Front)

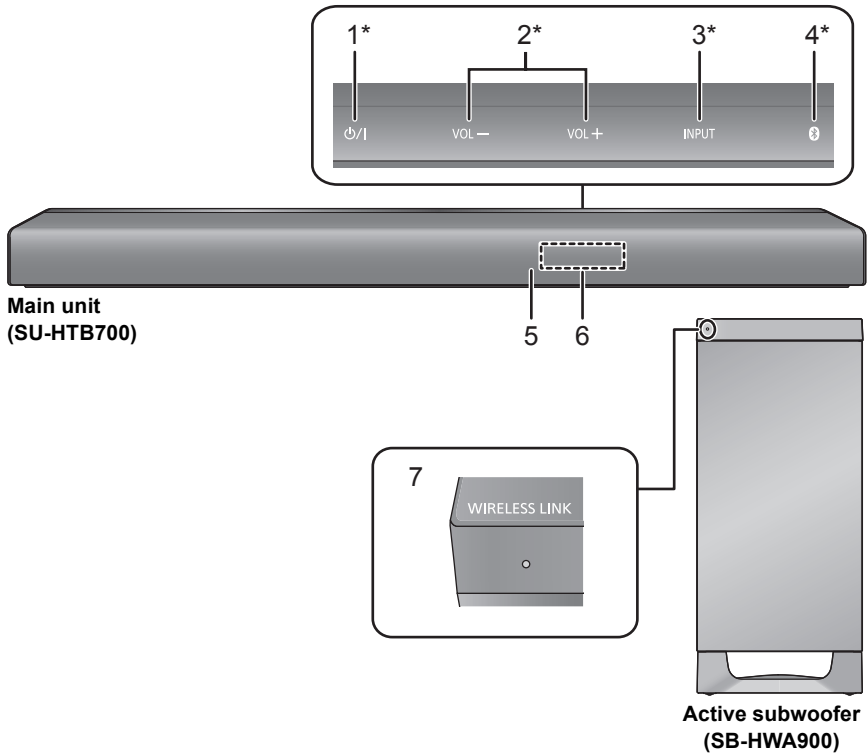

- 1 **[\odot /I] Standby/on switch (\odot /I)*
Touch to switch the unit from on to standby mode or vice versa. In standby mode, the unit is still consuming a small amount of power.**
- 2 **[VOL -] [VOL +]** Adjust the volume of this system* (\Rightarrow 17)
- 3 **[INPUT]** Select the input source* (\Rightarrow 17)
- 4 **[\odot]***
 - Select the Bluetooth® device as the source (\Rightarrow 17)
 - Bluetooth® pairing (\Rightarrow 18)
 - Disconnecting a Bluetooth® device (\Rightarrow 18)
- 5 Remote control signal sensor (\Rightarrow 7)

- 6 Display
- 7 WIRELESS LINK indicator (\Rightarrow 16)

* These switches work just by touching the marks. Each time you touch the switch, there will be a beep sound. The beep sound setting can be changed. (\Rightarrow 20, "BEEP")



- Do not place objects in front of this system.
- Do not place objects on the top surface of the main unit. Do not block the top surface of the main unit as it serves as ventilation.
- Regularly remove dust, etc., from this system. (\Rightarrow 29, "Clean this system with a soft, dry cloth")

This system (Others)



Main unit
(Bottom)

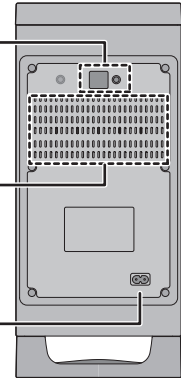
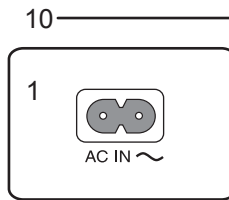
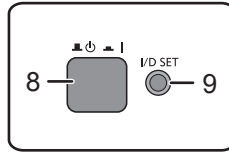
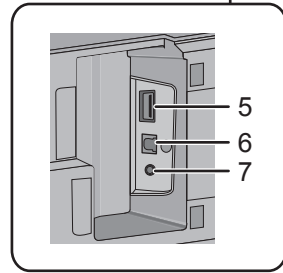
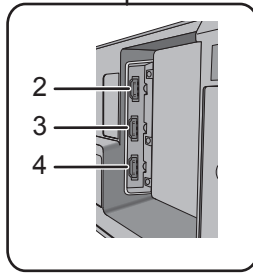
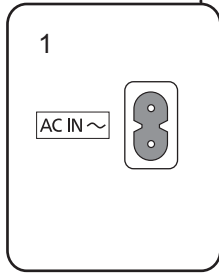

Active subwoofer
(Rear)

- 1 AC IN (~) terminal (⇒ 11)
- 2 HDMI AV OUT (TV (ARC)) terminal (ARC compatible) (⇒ 8)
- 3 HDMI AV IN (HDMI 2) terminal (⇒ 10)
- 4 HDMI AV IN (HDMI 1) terminal (⇒ 9, 10)
- 5 USB port (FOR UPDATE)
(DC 5 V --- 500 mA)
- 6 OPTICAL DIGITAL AUDIO IN (TV) terminal
(⇒ 8)
- 7 Ir SYSTEM terminal (⇒ 10)
- 8 [] Active subwoofer on/off button
(⇒ 16)

- 9 [I/D SET] I/D SET button
The main unit and the active subwoofer have already been paired at the time of purchase, so this button is not normally used. Use it when the main unit and the active subwoofer need to be paired again. (⇒ 27)
- 10 Ventilation holes

The symbols on this product represent the following.

~	AC
---	DC
□	Class II equipment (The construction of the product is double-insulated.)

Remote control

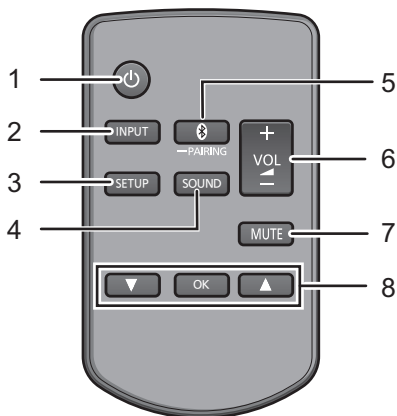

- 1 [⏻] Switch the main unit from on to standby or vice versa (⇒ 17)
- 2 [INPUT] Select the input source (⇒ 17)
- 3 [SETUP] Select the setup menu (⇒ 20)
- 4 [SOUND] Select the sound menu (⇒ 19)
- 5 [🔗 -PAIRING]
 - Select the Bluetooth® device as the source (⇒ 17)
 - Bluetooth® pairing (⇒ 18)
 - Disconnecting a Bluetooth® device (⇒ 18)
- 6 [+ VOL -] Adjust the volume of this system (⇒ 17)
- 7 [MUTE] Mute the sound (⇒ 17)
- 8 [▼][OK][▲] Select and confirm the option

■ Before using for the first time

Remove the insulation sheet **A**.

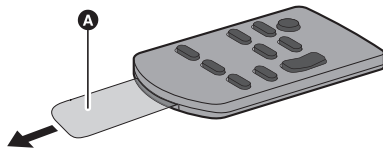

- Dispose of the insulation sheet responsibly after removing it.

■ To replace a button-type battery

Battery type: CR2025 (Lithium battery)

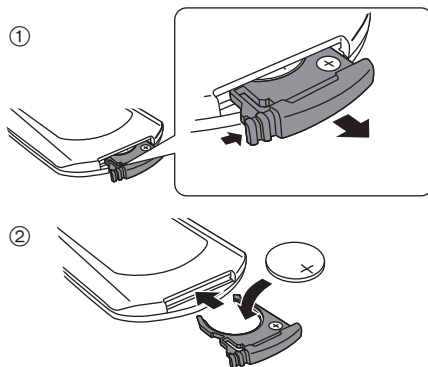

- Set the button-type battery with its (+) mark facing upward.

■ About remote control signal sensor

The remote control signal sensor is located on the main unit.

- Use the remote control within the correct operation range.
 - Distance: Within approx. 7 m directly in front
 - Angle: Approx. 20° up and down, 30° left and right

Step 1 Connections

Turn off all equipment before connection and read the appropriate operating instructions.

Do not connect the AC mains lead until all other connections are completed.

When connecting to 4K compatible equipment and 4K Ultra HD TV, use High Speed HDMI cables which support 18 Gbps bandwidth.

CAUTION
(Caution regarding the HDMI terminals on the main unit)



Hot surface
Do not touch.

Connection with the TV

Verify if the TV's HDMI terminal is labelled "HDMI (ARC)".

Labelled "HDMI (ARC)"

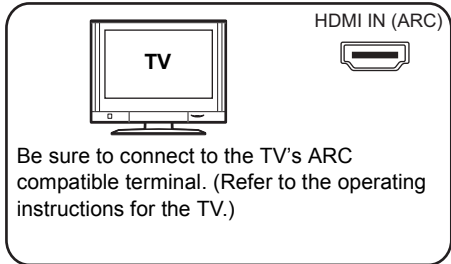
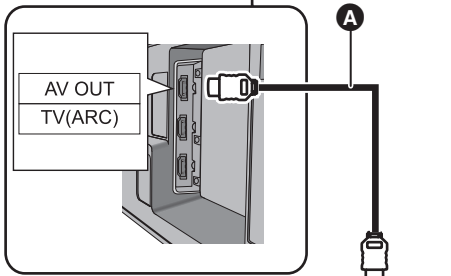

A HDMI cable

Not Labelled "HDMI (ARC)"

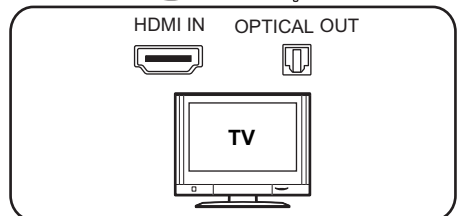
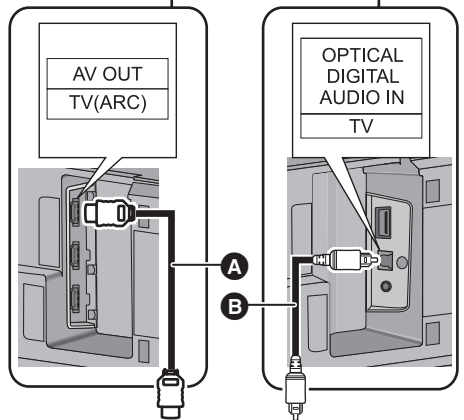

A HDMI cable

B Optical digital audio cable

- When you use the optical digital audio cable, insert the tip correctly into the terminal.

What is ARC?

ARC is an abbreviation of Audio Return Channel, also known as HDMI ARC. It refers to one of the HDMI functions. When a terminal labelled "ARC" and the "TV (ARC)" terminal on the main unit are connected by HDMI, the optical digital audio cable that is usually required in order to listen to sound from a TV is no longer required, and TV pictures and sound can be enjoyed with a single HDMI cable.

Connection with players, etc., supporting HDR10+ and Dolby Vision™

This system does not support HDR10+ and Dolby Vision™. When connecting to a player, TV, etc., that supports HDR10+ or Dolby Vision™, use the following connection.

- The name of the terminal may be different depending on the device that supports HDR10+. Refer to the operating instructions of the supporting device for details.
- If you connect this system and are then unable to view Netflix, use the following connection.
- VIERA Link does not work when you use this connection. (⇒ 22)

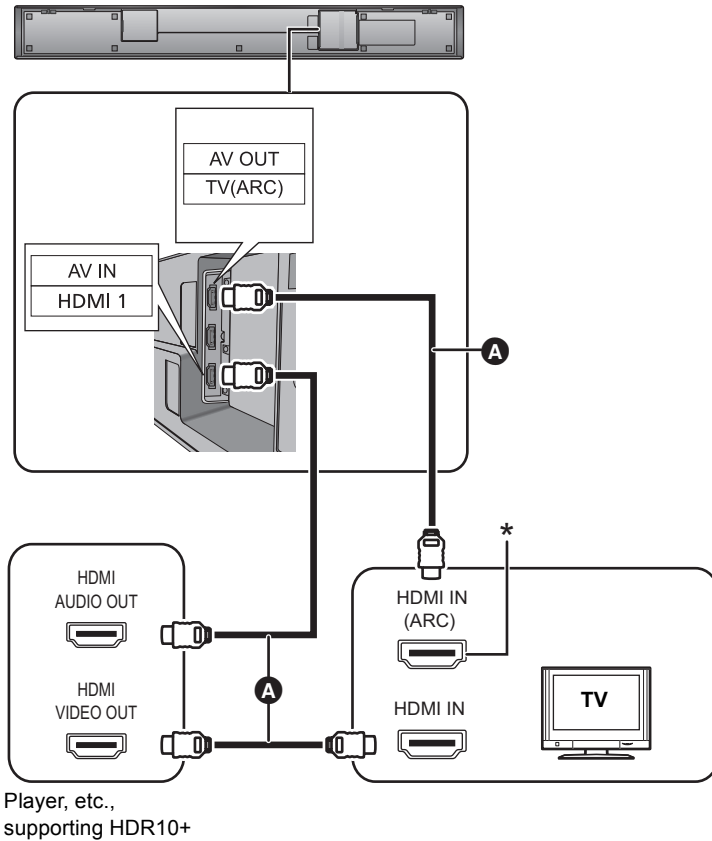

A HDMI cable

* If this terminal does not support ARC, also use an optical digital audio cable to connect the main unit and the TV. (⇒ 8, "Not Labelled "HDMI (ARC)"")

Connection from an HDMI compatible device

You can direct the audio signal from the connected Blu-ray Disc player, DVD player, Set Top Box, etc. to this system.

Preparation

- Connect the main unit to the TV. (⇒ 8)

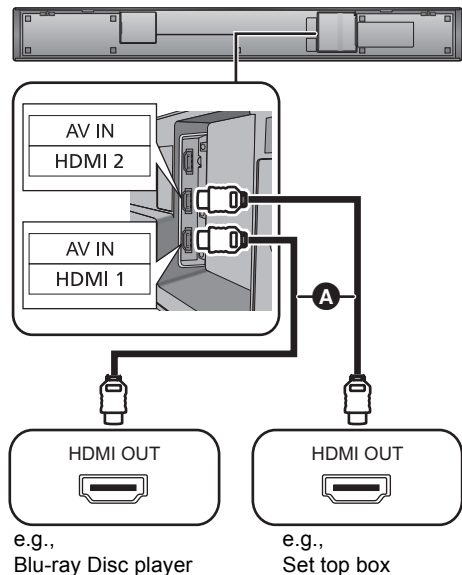

- A** HDMI cable



- Refer to the operating instructions of the connected HDMI compatible device for the necessary setting, to output the video and audio signals.

Using the IR Blaster

(When the remote control does not work properly)

Depending on how the main unit is setup, it may block the TV's remote control signal sensor, stopping the TV's remote control from working. Use the supplied Ir system cable if this occurs. The TV remote control signals received by the main unit are sent to the TV to operate it.

- For the operation range, refer to page 7.
- Do not use any other IR Blaster except the supplied one.

- 1 Connect the jack plug to the main unit's Ir SYSTEM terminal.

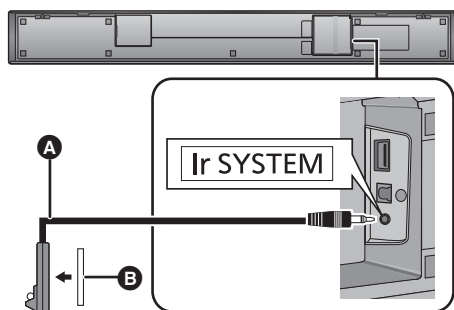

- A** IR Blaster (supplied)
B Adhesive tape (supplied)

- 2 Place the infrared emitter in sight of the TV's remote control signal sensor.

Placement example

On the rear of the main unit:

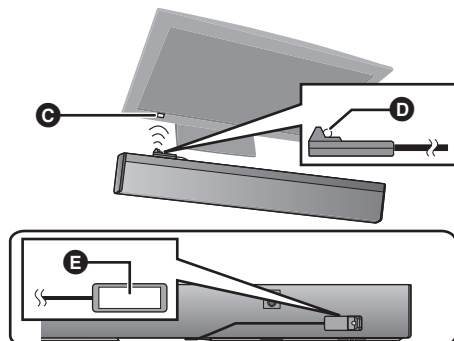

- C** TV remote control signal sensor
D Infrared emitter
E Adhesive tape (supplied)

3 Aim the TV's remote control at this system's remote control sensor and operate the TV.

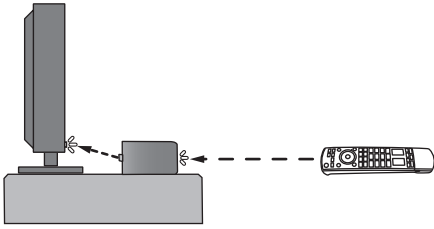

- For the location of the TV's remote control signal sensor, refer to the operating instructions for the TV.
- Select a location that suits the environment.
- Make sure to clean the surface, where the adhesive tape is to be attached.
- If you peel off the adhesive tape, the surface may become damaged and exposed adhesive may remain. Once you have confirmed the TV is operating correctly, secure it by attaching the adhesive tape.
- When the TV receives signals from both its remote control and the IR Blaster, their signals may interfere with each other, making it impossible for you to operate the TV. Try using the TV's remote control from a different angle.

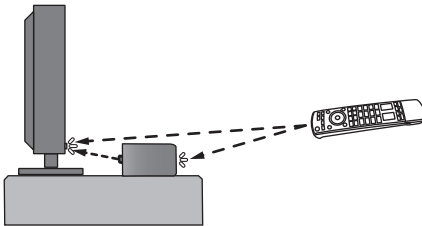

If the TV remote control does not work even after you have adjusted its angle, do not use the IR Blaster. Install the main unit so that the TV's remote control signal sensor is visible from the position where you operate the TV remote control.

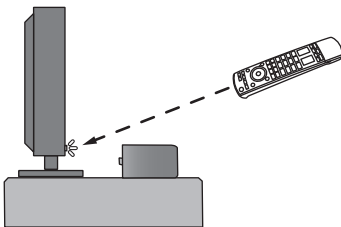

AC mains lead connection

- Connect only after all other connections are completed.

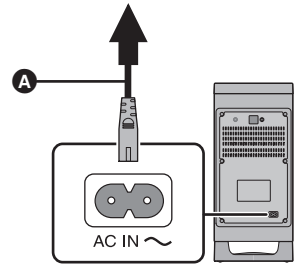
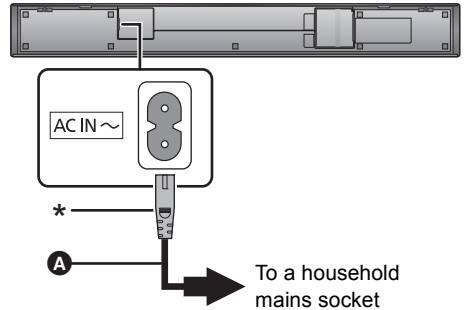

- **A** AC mains lead (supplied)
- * Insert the AC mains lead fully into the main unit.

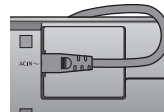

- This system consumes a small amount of AC power (⇒ 30) even when it is turned off. In the interest of power conservation, if you will not be using this system for a long time, unplug it from the household mains socket.
 - Operation is not possible using the IR Blaster if the AC mains plug is disconnected.

Saving energy

The main unit is designed to conserve its power consumption and save energy.

- The main unit will automatically switch to standby mode when no signal is input and no operation is performed for approx. 20 minutes. Refer to page 20, "AUTO OFF" to turn this function off.

Step 2 Placement

Safety Precautions

Professional installation is required.
The installation should never be done by any other than a qualified installation specialist.
PANASONIC DISCLAIMS ANY PROPERTY DAMAGE AND/OR SERIOUS INJURY, INCLUDING DEATH RESULTING FROM IMPROPER INSTALLATION OR INCORRECT HANDLING.

- Be sure to install the main unit as indicated within this operating Instructions.
- Attach using techniques suited to the structure and materials of the installation location.

Caution

- This system is to be used only as indicated in these instructions. Failure to do so may lead to damage to the amplifier and/or the speaker, and may result in the risk of fire. Consult a qualified service person if damage has occurred or if you experience a sudden change in performance.
- Do not attempt to attach the main unit to a wall using methods other than those described in this manual.



- Do not hold the main unit in one hand to avoid injury, you may drop the main unit when carrying it.
- To prevent damage or scratches, lay down a soft cloth and perform the assembly on it.
- Place the active subwoofer within a few meters of the main unit and in a horizontal position with the top panel facing upward.
- Do not use the main unit or the active subwoofer in a metal cabinet.
- Placing the active subwoofer too close to the walls and corners can result in excessive bass. Cover walls and windows with thick curtains.
- Keep magnetised items away. Magnetised cards, watches, etc., can be damaged if placed too close to the main unit and active subwoofer.

The active subwoofer

When carrying the active subwoofer

Take care not to damage the inside speaker unit.

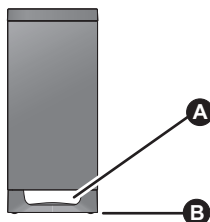

- A Do not hold the active subwoofer from this opening.**
The parts inside may get damaged.
- B Always hold the bottom of the active subwoofer when moving it.**

Wireless interference

Interference may occur if you are using other devices (wireless LAN/microwave ovens/cordless phones, etc.) that use the 2.4 GHz frequency band, causing some communication problems (sound is interrupted, sound skips, there is a lot of noise, etc.).

If this happens, separate the other electronic equipment from the main unit and active subwoofer so that interference does not occur.

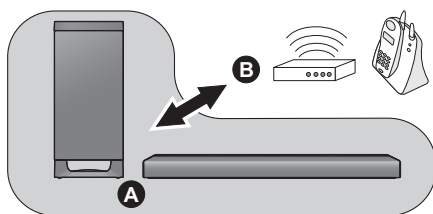

- A Main unit/active subwoofer**
- B Wireless router, cordless phone and other electronic devices**

When placing the main unit in a rack or on a table

Additionally required accessories (commercially available)

- Fall prevention cord (diameter: 1.5 mm to 2.0 mm)..... × 2
- Screw eyes (to attach the fall prevention cord) × 2



- Use commercially available screws that are capable of supporting over 45 kg.
- Use a cord that is capable of supporting over 45 kg.
- Lay the unit on a blanket or soft cloth for assembly.

1 Attach the cord to the main unit.

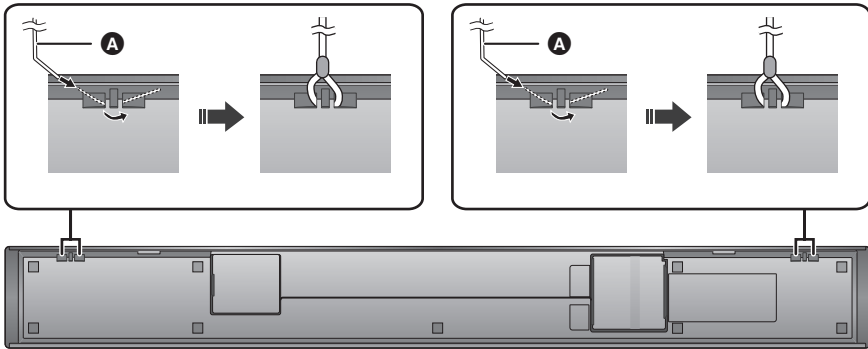

(Bottom)

A Cord*

- * If the cord cannot be threaded through the holes, try bending the cord in a location about 5 mm apart from the tip, at an angle of 45° (as illustrated above).

2 Place the main unit in the desired position and attach each cord onto the rack or table.

- Make sure that the slack of the cord is minimal.
- Do not lean the main unit against the TV or wall.

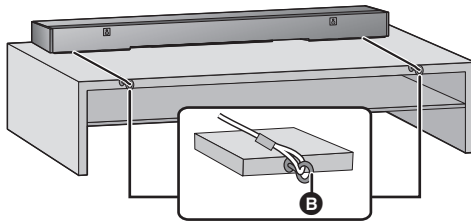

B Screw eye

- Attach at a position capable of supporting over 45 kg.
- Depending on the placement of the main unit, the screwing position of the screw eye may differ.

■ When placing the main unit in front of the TV

The main unit may block or interfere with the TV's various sensors (C.A.T.S. (Contrast Automatic Tracking System) sensor, remote control sensor, etc.) and the 3D Eyewear transmitters on a 3D compatible TV.

- If interference occurs, move the main unit further away from the TV. If the TV still does not function correctly, try using it in a rack or in the wall mount position.

When attaching the main unit to a wall

The main unit can be wall mounted using the supplied wall mount brackets, etc. Make sure that the screw used and the wall are strong enough to support the weight of at least 45 kg.

The screws and other items are not supplied as the type and size will vary with each installation.

- Refer to step 3 for details about the required screws.
- Be sure to attach the fall prevention cord as a secondary safety measure.

Supplied accessories

<input type="checkbox"/> 2 Screws		<input type="checkbox"/> 2 Wall mount brackets	
-----------------------------------	---	--	---

Additionally required accessories (commercially available)

- | | |
|--|-----|
| • Screws for wall mounting..... | × 2 |
| • Fall prevention cord (diameter: 1.5 mm to 2.0 mm)..... | × 2 |
| • Screw eyes (to attach the fall prevention cord) | × 2 |



- Use a cord that is capable of supporting over 45 kg.
- Lay the unit on a blanket or soft cloth for assembly.

1 Attach the cord to the main unit.

- Perform step 1 in "When placing the main unit in a rack or on a table". (⇒ 13)

2 Attach the wall mount brackets to the main unit.

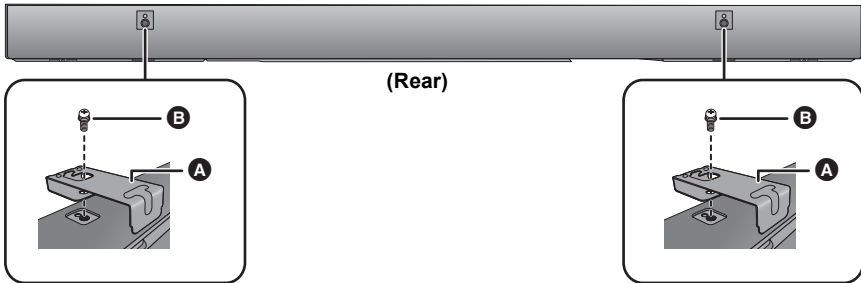

- A** Wall mount bracket (supplied)
- B** Screw (supplied)

3 Drive a screw into the wall.

- Use the measurements indicated below to identify the screwing positions on the wall.
- Leave at least 200 mm of space above of the main unit to allow enough space for fitting the main unit.
- Be sure to use a level to ensure that both mounting holes are level to each other.

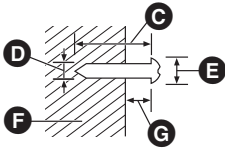

- C** At least 30 mm
- D** $\varnothing 4.0$ mm
- E** $\varnothing 7.0$ mm to $\varnothing 9.4$ mm
- F** Wall or pillar
- G** 2.5 mm to 4.5 mm

Front view (semi-transparent image)

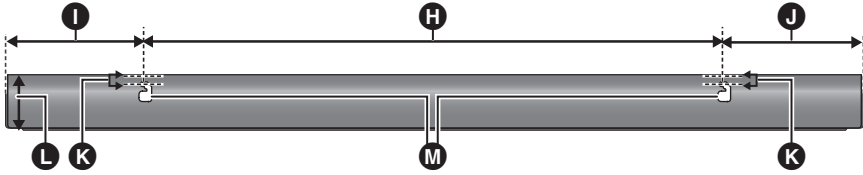

- H** 700 mm
- I** 175 mm
- J** 175 mm
- K** 8 mm
- L** 89 mm
- M** Wall mounting hole

4 Fit the main unit securely onto the screw(s).

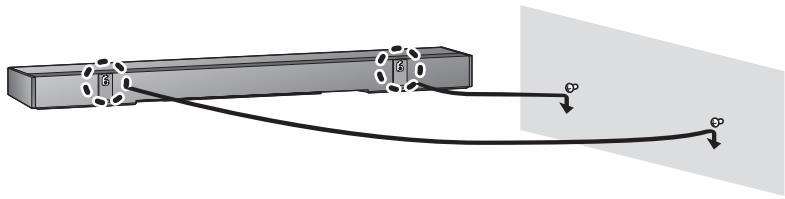

DO	DO NOT
<ul style="list-style-type: none"> • Move the speaker so that the screw is in this position. 	<ul style="list-style-type: none"> • In this position, the speaker will likely fall if moved to the left or right.

5 Secure the cord to the wall.

- Make sure that the slack of the cord is minimal.

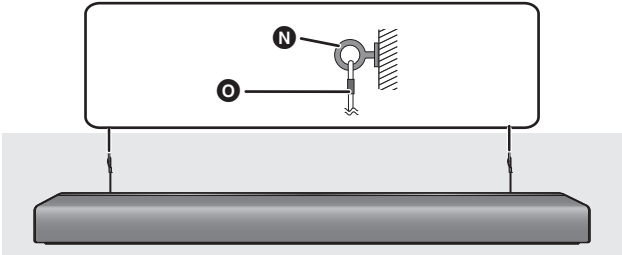

- N** Screw eye
- O** Cord

Step 3 Active subwoofer wireless connection

Preparation

- Turn on the main unit.

1 Press [].

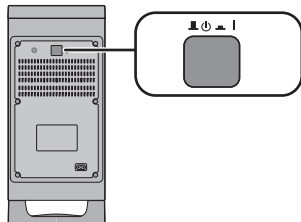



Active subwoofer on/off button []

Use this button to turn the active subwoofer on and off.

 I: The active subwoofer is on.

 : The active subwoofer is off.

The active subwoofer will still consume a small amount of power even when it is turned off (, ).

2 Check that the wireless link is activated.

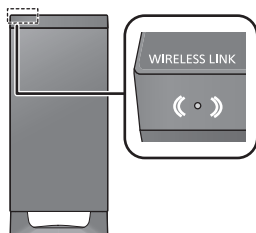

WIRELESS LINK indicator

Lights red:

The wireless link is not activated.

Refer to “The WIRELESS LINK indicator lights red.” to activate this. (⇒ 27)

Lights green:

The wireless link is activated.

Blinks green:

The active subwoofer is trying to activate the wireless link with the main unit.



- The wireless link will be activated when the main unit and the active subwoofer are both turned on.

Using this system

Preparation

- Turn on the active subwoofer.
- Turn on the TV and/or connected device.



1 Press [⏻] to turn on the main unit.

2 Select the source.

Press	To select
[INPUT]	Input changes in the following order each time you press [INPUT]. “TV” → “HDMI 1” → “HDMI 2” ↑ “BLUETOOTH” ←
[🔗 -PAIRING]	Select the Bluetooth® device as the source. (⇒ 18)

- This remote control cannot be used to control the operations of the connected devices.

■ When you select “HDMI 1” or “HDMI 2”

Change the input on the TV to the one this unit is connected to, then start play on the device connected to this unit.

■ When you select “BLUETOOTH”

Start play on the Bluetooth® device connected to this unit.

■ To adjust the volume of this system

Press [+ VOL -].

- Volume range: 0 to 100

■ To mute the sound

Press [MUTE].

- While muting, “MUTE” is indicated on the display.
- To cancel, press the button again or adjust the volume.
- Muting is cancelled if the main unit is turned off.



If this system does not operate as expected or sound is unusual, returning the settings to the factory preset may solve the problem. (⇒ 24)

- If there is sound coming out of the TV’s speakers, reduce the volume of the TV to its minimum.
- There may be a difference in the maximum volume value of the TV and the unit.
- When playing equipment connected to the HDMI AV IN terminal, to switch audio/video to the TV, switch input to the TV tuner. If VIERA Link (HDMI) (⇒ 22) is not enabled, also switch the input of this unit to TV.

Remote control code

When other Panasonic devices respond to this system’s remote control, change the remote control code on this system and the remote control.

Preparation

- Turn off all other Panasonic products.
- Turn on the main unit.
- Aim the remote control at this unit’s remote control sensor.

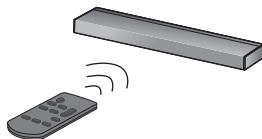

■ To set the code to “REMOTE 2”

While pressing and holding [MUTE], press and hold [OK] for more than 4 sec.

“REMOTE 2” is indicated on the display.

■ To set the code to “REMOTE 1”

While pressing and holding [MUTE], press and hold [▼] for more than 4 sec.

“REMOTE 1” is indicated on the display.

Bluetooth® operations



By using the Bluetooth® connection, you can listen to the sound of the Bluetooth® audio device from this system wirelessly.

- Refer to the operating instructions of the Bluetooth® device for further instruction on how to connect a Bluetooth® device.

Preparation

- Turn on the Bluetooth® feature of the device and place the device near the main unit.

Bluetooth® pairing

- 1 Press [ -PAIRING] to select “BLUETOOTH”.
 - If “PAIRING” is indicated on the display, go to step 3.
- 2 Press and hold [ -PAIRING] until “PAIRING” is indicated on the display.
- 3 Select “SC-HTB700” from the Bluetooth® device’s Bluetooth® menu.
 - A BD address (Bluetooth® Device address: an alphanumeric character string that is displayed by and unique to the device) may be displayed before the name of the Bluetooth® device is displayed.
 - If prompted for the passkey on the Bluetooth® device, enter “0000”.
 - Once the Bluetooth® device is connected, the name of the connected device will be indicated on the display for a few seconds.



- If you register more than 8 devices, ones that have not been connected for a long period of time may be deleted from the list of registered devices. In that case, pair with the deleted devices again.

Connecting a paired Bluetooth® device

- 1 Press [ -PAIRING] to select Bluetooth® mode.
 - This may display “LINKING” and automatically connect this system to the Bluetooth® device it was last connected to.
 - After “LINKING” is displayed, proceed to step 2 if “BLUETOOTH READY” is displayed.
- 2 After confirming that “BLUETOOTH READY” is indicated on the display, select “SC-HTB700” from the Bluetooth® device’s Bluetooth® menu.

■ Disconnecting a Bluetooth® device

Follow the step below if, for example, a connection has been made to any device other than the Bluetooth® device you want to connect to.

Press and hold [ -PAIRING] until the “BLUETOOTH READY” is indicated on the display.



- When “BLUETOOTH” is selected as the source, this system will automatically try and connect to the last connected Bluetooth® device. If the connection attempt fails, try to establish a connection again.
- This system can only be connected to one device at a time.
- To change the sound quality, refer to “LINK MODE”. (⇒ 20)
- Video and audio may be out of sync when you play back music accompanied by video.

Sound menu

1 Press [SOUND] repeatedly to select the sound effect and then press [OK].

- You can also press [▼] or [▲] repeatedly to select the setup item.

2 Press [▼] [▲] repeatedly to select the desired setting and then press [OK].

■ SOUND MODE

Select the sound mode to suit the TV programme or connected equipment.

STANDARD: Best suited for dramas and comedy shows.

STADIUM: Produces a realistic sound for live sports broadcasts.

MUSIC: Enhance the sound of musical instruments and songs.

CINEMA: Produces three-dimensional sound unique to movies.

NEWS: Enhance the voice of news and sports commentaries.

STRAIGHT*1: Output is 2.1 channels during stereo playback and 3.1 channels during multi-channel playback.

■ 3D SURROUND*1

This system not only pushes the sound field out to the left and right, but also upwardly to help realise an immersive sound effect.

e.g., Impression of the 3D surround effect

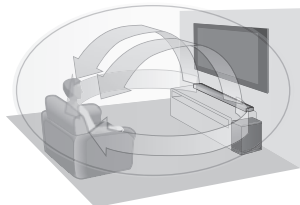

- The default setting is "OFF".
- The surround effect depends on the source.

■ SUBWOOFER

You can adjust the amount of bass.

Of the levels "LEVEL 1" to "LEVEL 4", the effect increases the higher the level number.

■ CLR DIALOG

You can change the level of dialogue clarity when you want to emphasise people's voices, etc.

Of the levels "LEVEL 1" to "LEVEL 4", the effect increases the higher the level number.

If the sound becomes unnatural, select "OFF".

- For DTS:X® content, change the level using "DTS:X DIALOG CONTROL".

■ DTS:X DIALOG CONTROL*2

You can change the level of dialogue clarity when you want to emphasise people's voices, etc.

This has an effect only when playing back DTS:X® content.

Of the levels "LEVEL 0" to "LEVEL 6", the effect increases the higher the level number.

■ DUAL AUDIO*2

Sets the preferred audio channel mode when there are two audio modes received by this system.

M1: Main

M2: Secondary

M1+M2: Main + Secondary

This effect only works if the audio output of the TV or player is set to "Bitstream" and "Dual Mono" is available in the sound source.

■ DRC*2

You can listen at low volumes but still hear dialogue clearly.

If the sound becomes unnatural, select "OFF".

- When playing back "Dolby TrueHD" audio, if "AUTO" is selected, then depending on the content, the effect output may be the one when "ON" is selected.
- This function is enabled only when Dolby Audio™ (Dolby Digital, Dolby Digital Plus, or Dolby TrueHD), Dolby Atmos®, or DTS® signals are being input.

■ AGC

Auto gain control prevents sudden loud sound by reducing the sound level automatically when the input is too high.

This function is suitable for TV broadcast that has sound level difference.

If the sound becomes unnatural, select "OFF".

■ LOW VOL MODE

Enhance the dialogue in low volume condition.

Select "OFF" to cancel this effect if the dialogue does not sound natural in low volume condition.

■ WALL MOUNT

Select the appropriate speaker placement mode to suit your placement method. This system will adjust the sound effect according to the placement mode setting.

ON: For wall mounting layout

OFF: For table top layout

- The default setting is "OFF".



- Changed settings will be kept until it is changed again, unless otherwise indicated.
- *1 The effects of "STRAIGHT" in "SOUND MODE" and "ON" in "3D SURROUND" will not be applied simultaneously.
- *2 Effects are disabled when the input selected is "BLUETOOTH". It is also not possible to change the settings.

Audio format

You can view the current audio format.

Press and hold [SOUND] for more than 4 sec.



- The audio format is displayed for about 3 seconds.
- No audio format is displayed if input to this unit is Bluetooth®.

Setup menu

1 Press [SETUP] repeatedly to select the setup item and then press [OK].

- You can also press [▼] or [▲] repeatedly to select the setup item.

2 Press [▼] [▲] repeatedly to select the desired setting and then press [OK].

■ DIMMER

Switch the brightness of the display.

- While "DISPLAY OFF" is set, the display lights for about 5 seconds if operations are performed on the main unit or with the remote control.
- While "DISPLAY OFF" is set, a part of the display lights if the display is off but the main unit is on.

■ BEEP

A beep sounds when you touch the switch on the main unit or when you turn the unit on/off.

- This works during muting as well.

■ AUTO OFF

The main unit automatically is turned off if there is no audio input and when you do not use it for approx. 20 minutes.

- When this is set, the display shows "P.OFF 1MIN" to indicate that the main unit will turn off in approximately 1 minute.
- If "STANDBY MODE" or "VIERA LINK" is set to "ON", this function will also be set to "ON". To change the setting, set "STANDBY MODE" and "VIERA LINK" to "OFF". (⇒ 21)

■ VOL LIMITATION

When this function is set to "ON", if the volume exceeds 50 when the main unit is turned off, then the volume is set to 50 when the main unit is turned on.

■ LINK MODE

Change the Bluetooth® transmission mode to prioritise transmission quality or sound quality. Make sure that the Bluetooth® device is not connected ("BLUETOOTH READY" is indicated on the display).

MODE 1: Emphasis on connectivity.

MODE 2: Emphasis on sound quality.

- The default setting is "MODE 2".
-

■ VIERA LINK

Turn on the VIERA Link function.

Select "OFF" when your HDAVI Control device does not work correctly with this system.

- ARC will be disabled. Connect an optical digital audio cable.
- Turn off all connected devices and then turn them on again after changing the setting.

■ STANDBY MODE

When this function is set to "ON", then the main unit automatically turns on in the following cases.

– When a Bluetooth® connection is established to the main unit from a paired Bluetooth® device.

- The default setting is "ON".
- If this function is set to "ON", the standby power consumption will increase. (⇒ 30)

■ RESET

This restores the settings to the factory presets.

- For details, refer to "To return to the factory preset." (⇒ 24)

■ F/W VERSION

You can check the firmware version.

- The version of the installed firmware is displayed when you press [OK] while "F/W VERSION" is being displayed. Press [OK] again to stop the display.



- Changed settings will be kept until it is changed again, unless otherwise indicated.

Firmware update

Occasionally, Panasonic may release updated firmware for this system that may add or improve the way a feature operates. These updates are available free of charge.

For the latest information, refer to the site below.
<https://panasonic.jp/support/global/cs/audio/>
(This site is in English only.)

Preparation

- Download the latest firmware from the following website and store it to a USB device to update the firmware.

<https://panasonic.jp/support/global/cs/audio/>
(This site is in English only.)

- 1 Turn off the main unit, then connect the USB device containing the latest firmware to the main unit.

- Depending on the shape of the USB device, the cables connected to other terminals may obstruct the connection. In that case, unplug the connection cables around the USB device first, then reconnect it.

- 2 Touch [⏻/⏪] on the main unit to turn it on.

DO NOT DISCONNECT the AC mains lead while one of the following messages is displayed.

"CHECK □□ %"

"UPDATE □□□ %"

("□" stands for a number.)

- During the update process, no other operations can be performed.

When the update has finished successfully, "SUCCESS" is displayed.

- 3 Disconnect the USB device.
- 4 Touch [⏻/⏪] on the main unit to turn it off, then touch [⏻/⏪] on the main unit to turn it on.



- If there are no updates, "NO NEED" is displayed.
- You cannot output sound from this unit while updating the firmware.
- To view the TV during update, change the settings on the TV to have the sound output from the TV's speakers. Refer to the operating instructions of the TV for details.
- If "PLEASE DISCONNECT USB DEVICE" appears on the display, disconnect the USB device. After that, touch [⏻/⏪] on the main unit to turn it off, then touch [⏻/⏪] again to turn it on.

Linked operations with the TV (VIERA Link “HDAVI Control™”)

What is VIERA Link “HDAVI Control”?

VIERA Link “HDAVI Control” is a convenient function that offers linked operations of this system, and a Panasonic TV (VIERA) under “HDAVI Control”.

You can use this function by connecting the equipment with an HDMI cable. See the operating instructions for connected equipment for operational details.

Preparation

- ① Confirm that the HDMI connection has been made. (⇒ 8, 10)
- ② Set the “HDAVI Control” operations on the connected equipment (e.g., TV).
- ③ For the optimal “HDAVI Control” operations change the following settings on the connected TV*1.
 - Set the default speaker settings to this system.*2
 - Set the speaker selection settings to this system.
- ④ Turn on all “HDAVI Control” compatible equipment and select the TV’s input for this system so that the “HDAVI Control” function works properly.
- ⑤ If a device is connected to the HDMI AV IN terminal, start play to check that the picture is displayed on the TV correctly.

When the connection or settings are changed, repeat this procedure.

- *1 The availability and function of the settings may vary depending on the TV. Refer to the operating instructions for the TV for details.
- *2 If the TV has a default speaker setting within the VIERA Link setting items, choosing this system as the default speaker will automatically change the speaker selection to this system.



- VIERA Link “HDAVI Control”, based on the control functions provided by HDMI which is an industry standard known as HDMI CEC (Consumer Electronics Control), is a unique function that we have developed and added. As such, its operation with other manufacturers’ equipment that supports HDMI CEC cannot be guaranteed.
- This unit supports “HDAVI Control 5” function. “HDAVI Control 5” is the standard for Panasonic’s HDAVI Control compatible equipment. This standard is compatible with Panasonic’s conventional HDAVI equipment.
- Please refer to individual manuals for other manufacturers’ equipment supporting VIERA Link function.

What you can do with VIERA Link “HDAVI Control”

To make sure that the audio is output from this system, turn the main unit on by using the TV’s remote control and selecting home cinema from the speaker menu of VIERA Link menu. The availability and function of the settings may vary depending on the TV. Refer to the operating instructions for the TV for details.

■ Speaker control

You can select whether audio output is from this system or the TV speakers by using the TV menu settings.

Home cinema

This system is active.

- When the main unit is in standby mode, changing the TV speakers to this system in the VIERA Link menu will automatically turn the main unit on.
- You can control the volume setting of this system using the volume or mute button on the TV remote control.
- If you turn off the main unit, TV speakers will be automatically activated.
- Audio will automatically be output from this system if the TV is compatible to VIERA Link “HDAVI Control 4” or later.

TV

TV speakers are active.

- The volume of this system is set to its minimum.

■ Automatic input switching

When the following operations are performed, the main unit will automatically change the input to the corresponding source.

- When play starts on an HDMI connected device.*3
- When the TV input or the TV channel is changed.

*3 If the speaker output setting on the TV is set to this system, the TV and the main unit turn on automatically (Power on link).

■ Power off link

When the TV is turned off, the main unit also turns off automatically.

(This function does not work when “BLUETOOTH” is the source.)

■ Automatic lip-sync function (for HDAVI Control 3 or later)

Delay between audio and video is automatically adjusted by adding time-lag to the audio output, enabling you to enjoy smooth audio for the picture.



- It may take up to 8 seconds for sound to be output from this unit after turning the TV (VIERA) on. You can reduce the amount of time it takes for sound to be output by using an optical digital audio cable. If you do so, reconnect the HDMI cable to a non-ARC compatible HDMI terminal on the TV (VIERA). (⇒ 8)
- The delay information is automatically set if the TV is compatible to VIERA Link “HDAVI Control 3” or later and the VIERA Link is set to on.
The setting causes a sound delay of approximately 0.04 seconds when connected to a Panasonic TV (VIERA) with VIERA Link (HDMI) version 2 or earlier or a TV from another manufacturer.

Troubleshooting

Before requesting service, make the following checks. If you are in doubt about some of the check points, or if the solutions indicated in the following guide do not solve the problem, consult your dealer for instructions.

If this system does not operate as expected, returning the settings to the factory preset may solve the problem.

To return to the factory preset.

- ① Press [SETUP] repeatedly to select "RESET" and then press [OK].
 - You can also press [▼] or [▲] repeatedly to select the setup item.
- ② Press [▼] [▲] to select "OK?YES" and then press [OK].
 - "RESET" blinks on the display. After the "RESET" display goes out, "TV" is selected as the source for this system.
 - The remote control code will return to "REMOTE 1" when this system is returned to the factory preset. To change the remote control code, refer to "Remote control code" (⇒ 17).

The remote control does not work properly.

- The battery is depleted. Replace it with a new one. (⇒ 7)
- It is possible that the insulation sheet has not been removed. Remove the insulation sheet. (⇒ 7)
- It may be necessary to set the code of the remote control again after changing the battery of the remote control. (⇒ 17)
- Use the remote control within the correct operation range. (⇒ 7)

The main unit is automatically switched to standby mode.

"AUTO OFF" function is on.

The main unit will automatically switch to standby mode when no signal is input and no operation is performed for approx. 20 minutes. Refer to page 20 to turn this function off.

The main unit is turned off when the TV's speakers are selected in the speaker control.

This is a normal feature when using VIERA Link (HDAVI Control 4 or later). Please read the operating instructions for the TV for details about its power save feature. (⇒ 22)

General operation

The unit does not work.

Operations are not done properly.

- ① Touch [⏻] on the main unit to turn it off.
 - If the main unit still does not turn off, touch and hold [⏻] on the main unit for at least 5 sec. This will force turn off the main unit. Alternatively, disconnect the AC mains lead, wait for at least 3 minutes, then reconnect it.
- ② Touch [⏻] on the main unit to turn it on. (It may take some time for the main unit to be turned on.)

Consult your dealer if the problem persists.

No power.

- Unplug the AC mains lead for at least 3 minutes before plug in again.
- After turning the main unit on, if the main unit immediately turns off, unplug the AC mains lead and consult your dealer.
- If the main unit does not turn on by turning on TV (HDAVI Control), turn on the main unit manually.
If the problem persists, refer to "HDMI" in "Troubleshooting".

The switches on the main unit do not work.

[⏻/], [VOL -], [VOL +], [INPUT], and [⊗] on the main unit are touch keys. Touch the switches with your finger. They may not work if operated with your fingernails or hands wearing gloves.

Colour irregularities on a CRT TV.

If colour irregularities appear on the TV, turn off the TV for about 30 minutes and move TV away from this unit slightly. If this does not fix the problem, move this unit away from the TV.

The TV remote control does not work even when the IR Blaster is connected to the main unit.

When the TV receives signals from both its remote control and the IR Blaster, their signals may interfere with each other, making it impossible for you to operate the TV. Adjust the angle at which you operate the TV remote control. (⇒ 11)

HDMI

This system does not operate correctly.

If the HDMI cable is connected to the wrong terminal (HDMI AV IN or HDMI AV OUT), this system will not operate correctly. Turn the main unit off, disconnect the AC mains lead and reconnect the HDMI cable(s). (⇒ 8, 10)

VIERA Link related operations no longer function properly.

- Check the VIERA Link setting on the connected devices.
 - Turn on VIERA Link function on the connected devices.
 - Select this system as the speaker in the TV's VIERA Link menu.
- Have you turned the VIERA Link settings off? (⇒ 21)
- When the HDMI connections are changed, after a power failure or after the AC mains lead has been removed, VIERA Link operations may not function properly.
 - Turn on all the devices that are connected to the TV with an HDMI cable and then turn the TV on.
 - Turn off the VIERA Link settings of the TV and turn it on again. For details refer to the operating instructions for the TV.
 - While the main unit and the TV are connected with the HDMI cable, turn on the TV and then remove the main unit's AC mains lead and reconnect it again.

The first few seconds of audio cannot be heard when using the HDMI connection.

This may occur when a DVD is played back by chapter, for example. The situation may improve by changing the digital audio output setting on the connected device from "Bitstream" to "PCM".

When operating an HDMI compatible device of a different brand, the main unit reacts in an unwanted manner.

HDAVI Control commands may use a different signal depending on the brand of the device. The situation may improve by selecting a setting that does not use VIERA Link. (⇒ 21)

When the main unit is turned on or off, audio and video are temporarily disabled.

When the main unit is turned on or off it is normal for the audio and video to be temporarily disabled. This is not a malfunction.

The images from this system do not appear on the TV.

When outputting in 60p (4K), images may be distorted depending on the HDMI cable. Use High Speed HDMI cables which support 18 Gbps bandwidth.

Bluetooth®

Pairing cannot be done.

Check the Bluetooth® device condition.

The device cannot be connected.

- The pairing of the device was unsuccessful or the registration has been replaced. Try pairing the device again. (⇒ 18)
- This system might be connected to a different device. Disconnect the other device and try pairing the device again.

The device is connected but audio cannot be heard through this system.

For some Bluetooth® devices, you have to set the audio output to "SC-HTB700" manually. Read the operating instructions for the device for details.

Connection is interrupted.

Sound is interrupted/sound skips/there is a lot of noise.

- Remove any obstacle between the main unit and the device.
- Other devices that use the 2.4 GHz frequency band (wireless router, microwaves, cordless phones, etc.) are interfering. Bring the Bluetooth® device closer to the main unit and distance it from the other devices.
- Select "MODE 1" for stable communication. (⇒ 20, "LINK MODE")

If the above does not fix the problem, you may be able to fix the problem by reconnecting this unit and the Bluetooth® device. (⇒ 18)

Sound

No sound (or image).

- Turn muting off. (⇒ 17)
 - Check the connections to the other devices. (⇒ 8 - 10)
 - Make sure that the received audio signal is compatible with this system. (⇒ 30)
 - Turn this system off and then on again.
 - If the main unit is connected to the TV with only an HDMI cable, make sure that the TV's HDMI terminal is labelled "HDMI (ARC)". If not, connect using the optical digital audio cable. (⇒ 8)
 - If the main unit is connected to a Panasonic TV and turned on using the remote control or the touch key on the main unit, sound might not be output from this system. In this case, turn the main unit on using the TV's remote control. (⇒ 22)
 - If the connections are correct, there might be a problem with the cables. Redo the connections with different cables.
 - Check the audio output settings on the connected device.
 - The situation may improve by changing the digital audio output setting on the connected device from "Bitstream" to "PCM".
-

The dual audio cannot be changed from main to secondary.

If the audio received from the connected device is not "Dual Mono" or the output setting is not "Bitstream", the setting cannot be changed from this system. Change the setting on the connected device.

The volume is lowered when the main unit is turned on.

"VOL LIMITATION" is on.

If the main unit is turned off with the volume setting in the greater half (above 50), the main unit will automatically lower the volume to the middle (50) when the main unit is turned on.

(⇒ 20)

The dialogue is too persistent or the dialogue does not sound natural.

This system has a function to make the dialogue stand out when the volume is low. (⇒ 19)

The sound lags behind the image.

Depending on the TV, when this unit is connected to it via Bluetooth®, the sound output from this unit may lag behind the TV image. Connect this unit and the TV with an HDMI cable/optical digital audio cable. (⇒ 8)

Sound stops.

The power of the main unit turns off automatically.

(When the main unit detects a problem, a safety measure is activated and the main unit automatically switches to standby mode.)

- There is a problem with the amplifier.
- Is the volume extremely high?
If so, lower the volume.
- Is this system placed in an extremely hot place?
If so, move this system to a cooler place and wait a few moments and then try to turn it on again.

If the problem persists, confirm the display, turn this system off, remove the AC mains lead cord and consult your dealer. Please be sure to remember the display that was indicated and inform the dealer.

Active Subwoofer

No power.

Ensure the AC mains lead of the active subwoofer is connected properly.

After turning the subwoofer on, it immediately turns off.

Unplug the AC mains lead and consult your dealer.

No sound from the subwoofer.

- Check that the active subwoofer is turned on.
 - Check that the WIRELESS LINK indicator lights green. (⇒ 16)
-

The WIRELESS LINK indicator lights red.

- There is no link between the main unit and the active subwoofer. Check that the main unit is turned on.
- The active subwoofer and the main unit may not be paired correctly. Try the following operation. (Wireless pairing)
 - ① Turn on the main unit and active subwoofer.
 - ② Press and hold [I/D SET] on the rear of the active subwoofer for more than 3 sec. (The WIRELESS LINK indicator will blink in red.)
 - ③ While pressing and holding [INPUT] on remote control, touch and hold [VOL +] on the main unit for more than 4 sec. ("SUBWOOFER PAIRING" will be indicated on the display.)
 - When the wireless pairing is successful, "PAIRED" will be indicated on the display for 2 sec and WIRELESS LINK indicator lights green.
 - ④ Turn the main unit off and on.
- Consult your dealer if the problem persists.

Main unit displays

"F61"

- There is a problem with the amplifier of the system.
 - Disconnect the AC mains lead and consult the dealer.
-

"F70 DSP"

- Turn off the main unit and then switch it on again.
-

"F70 EEPROM" / "F77"

- Disconnect the AC mains lead and consult the dealer.
-

"F70 HDMI" / "U701" / "U703"

- Check HDMI connection.
 - Turn off the main unit and then switch it on again.
 - Disconnect the HDMI cable.
-

"F703"

- Turn off the main unit and then switch it on again.
 - Consult your dealer if the problem persists.
-

"F76"

- There is a problem with the power supply.
 - Disconnect the AC mains lead and consult the dealer.
-

"U704"

This system is receiving unsupported video format signal from the input source.

- Change the video resolution setting on the connected device. (Refer to the operating instructions for the device.)
 - If there is no image, connect the device directly to the TV to change the settings.
-

"U705"

The TV's HDMI terminal connected to the main unit or the TV's setting is not compatible with the HDCP 2.2 playback source.

- Ensure to connect to the TV's HDCP 2.2 compatible terminal.
- Ensure the TV's HDMI HDCP setting corresponds to HDCP 2.2.

(Refer to the operating instructions for the TV.)

“USB OVER CURRENT ERROR”

The USB device is drawing too much power.

- Disconnect the USB device. After that, turn off the main unit and then switch it on again.
 - Turn the main unit off and then on again.
-

“LOAD FAIL”

The firmware loading has failed. Check to see if the correct firmware is stored on the USB device.

“LINKING”

- This system is trying to connect to the last connected Bluetooth® device when “BLUETOOTH” is selected.
-

“REMOTE □” (“□” stands for a number.)

The remote control and this system are using different codes. Change the code on the remote control. (⇒ 17)

Unit care

■ Clean this system with a soft, dry cloth

(Pull out the AC mains lead from the socket before maintenance.)

- When dirt is heavy, wring a cloth moistened in water tightly to wipe the dirt, and then wipe it with a dry cloth.
- When cleaning the speakers, use a fine cloth. Do not use tissues or other materials (towels, etc.) that can fall apart. Small grains may get stuck inside the speaker cover.
- When cleaning the top surface (A) of the main unit, wipe left and right along the line.

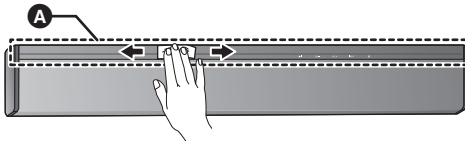

- Never use alcohol, paint thinner or benzene to clean this system.
- Before using chemically-treated cloth, carefully read the instructions that came with the cloth.

■ To dispose or transfer this system

This system may keep the user settings information in the main unit. If you discard the main unit either by disposal or transfer, then follow the procedure to return all the settings to the factory presets to delete the user settings. (⇒ 24, "To return to the factory preset.")

- The operation history may be recorded in the memory of the main unit.

Licenses

Dolby, Dolby Audio, Dolby Atmos, and the double-D symbol are trademarks of Dolby Laboratories.

For DTS patents, see <http://patents.dts.com>.
Manufactured under license from DTS, Inc.
DTS, the Symbol, DTS and the Symbol together, DTS:X, the DTS:X logo, Virtual:X, and the DTS Virtual:X logo are registered trademarks or trademarks of DTS, Inc. in the United States and/or other countries.
© DTS, Inc. All Rights Reserved.

The product with the Hi-Res Audio logo is conformed to Hi-Res Audio standard defined by Japan Audio Society.
The logo is used under license from Japan Audio Society.

The terms HDMI and HDMI High-Definition Multimedia Interface, and the HDMI Logo are trademarks or registered trademarks of HDMI Licensing Administrator, Inc. in the United States and other countries.

HDAVI Control™ is a trademark of Panasonic Corporation.

The Bluetooth® word mark and logos are registered trademarks owned by Bluetooth SIG, Inc. and any use of such marks by Panasonic Corporation is under license.
Other trademarks and trade names are those of their respective owners.

FLAC Decoder
Copyright (C) 2000,2001,2002,2003,2004,2005,2006,2007, 2008,2009 Josh Coalson
Redistribution and use in source and binary forms, with or without modification, are permitted provided that the following conditions are met:
– Redistributions of source code must retain the above copyright notice, this list of conditions and the following disclaimer.
– Redistributions in binary form must reproduce the above copyright notice, this list of conditions and the following disclaimer in the documentation and/or other materials provided with the distribution.
– Neither the name of the Xiph.org Foundation nor the names of its contributors may be used to endorse or promote products derived from this software without specific prior written permission.

THIS SOFTWARE IS PROVIDED BY THE COPYRIGHT HOLDERS AND CONTRIBUTORS "AS IS" AND ANY EXPRESS OR IMPLIED WARRANTIES, INCLUDING, BUT NOT LIMITED TO, THE IMPLIED WARRANTIES OF MERCHANTABILITY AND FITNESS FOR A PARTICULAR PURPOSE ARE DISCLAIMED. IN NO EVENT SHALL THE FOUNDATION OR CONTRIBUTORS BE LIABLE FOR ANY DIRECT, INDIRECT, INCIDENTAL, SPECIAL, EXEMPLARY, OR CONSEQUENTIAL DAMAGES (INCLUDING, BUT NOT LIMITED TO, PROCUREMENT OF SUBSTITUTE GOODS OR SERVICES; LOSS OF USE, DATA, OR PROFITS; OR BUSINESS INTERRUPTION) HOWEVER CAUSED AND ON ANY THEORY OF LIABILITY, WHETHER IN CONTRACT, STRICT LIABILITY, OR TORT (INCLUDING NEGLIGENCE OR OTHERWISE) ARISING IN ANY WAY OUT OF THE USE OF THIS SOFTWARE, EVEN IF ADVISED OF THE POSSIBILITY OF SUCH DAMAGE.

Specifications

AMPLIFIER SECTION

RMS OUTPUT POWER (non-simultaneous drive)	
FRONT SPEAKER (L/R)	42 W+42 W (1 kHz, T.H.D. 10.0 %, 8 Ω, 20 kHz LPF)
FRONT SPEAKER (Centre)	42 W (1 kHz, T.H.D. 10.0 %, 8 Ω, 20 kHz LPF)
SUBWOOFER	250 W (100 Hz, T.H.D. 10.0 %, 8 Ω, 20 kHz LPF)
Total RMS OUTPUT POWER	376 W

TERMINALS SECTION

HDAVI Control	This unit supports "HDAVI Control 5" function
HDMI AV input (HDMI 1)	1
input connector	Type A (19 pin)
HDMI AV input (HDMI 2)	1
input connector	Type A (19 pin)
HDMI AV output (TV (ARC))	1
output connector	Type A (19 pin)
Digital Input	Optical digital input (Optical terminal)
IR Blaster	
Terminal Type	Ø3.5 mm jack
USB Port	For UPDATE

SPEAKER SECTION

FRONT SPEAKER (L/R) Built in Main set	
Type	1 way, 1 speaker (Bass reflex)
Speaker Unit(s)	
Fullrange	6.5 cm×1/ch, Cone type
Impedance	8 Ω
FRONT SPEAKER (Centre) Built in Main set	
Type	1 way, 1 speaker (Closed)
Speaker Unit(s)	
Fullrange	6.5 cm×1/ch, Cone type
SUBWOOFER	
Type	1 way, 1 speaker (Bass reflex)
Speaker Unit(s)	
Sub woofer	16 cm×1, Cone type

GENERAL

Power consumption	
Main unit	41 W
Active subwoofer	48 W
Standby	
Main unit	0.2 W (Bluetooth Standby Off)*1 0.3 W (Bluetooth Standby On)*1
Active subwoofer	
Power switch off	0.3 W
The wireless link is not activated	0.6 W

Power supply	AC 220 V to 240 V, 50 Hz
Dimensions (W×H×D)	
Main unit	
For table top layout	1050 mm×78 mm×129 mm
For wall mounting layout	1050 mm×89 mm×133 mm
Active subwoofer	180 mm×408 mm×306 mm
Mass	
Main unit	Approx. 4.5 kg
Active subwoofer	Approx. 5.4 kg
Operating temperature range	0 °C to +40 °C
Operating humidity range	35 % to 80 % RH (no condensation)

FORMAT SECTION

HDMI AV input

LPCM (Max 7.1 ch)
Dolby Digital
Dolby TrueHD
Dolby Digital Plus
Dolby Atmos®
DTS®
DTS-ES Discrete 6.1
DTS-ES Matrix 6.1
DTS® 96/24
DTS-HD® High Resolution Audio
DTS-HD® Master Audio
DTS-Express
DTS:X®

HDMI AV input (TV(ARC))

LPCM (2 ch)
Dolby Digital
Dolby Digital Plus
Dolby Atmos® (Dolby Digital Plus)
DTS®
DTS-ES Discrete 6.1
DTS-ES Matrix 6.1
DTS® 96/24

Optical digital input

LPCM (2 ch)
Dolby Digital
DTS®
DTS-ES Discrete 6.1
DTS-ES Matrix 6.1
DTS® 96/24

WIRELESS SECTION

Wireless module

Frequency Range

2.40335 GHz to 2.47735 GHz

No. of channels

38

Bluetooth® SECTION

Bluetooth® System Specification

Bluetooth® Ver.2.1+EDR

Wireless Equipment Classification

Class 2 (2.5 mW)

Supported Profiles

A2DP/AVRCP

Supported Codec

SBC

Frequency Band

2.4 GHz Band FH-SS

Operating Distance

Approx. 10 m Line of sight*2



- Specifications are subject to change without notice.
- Mass and dimensions are approximate.
- Total harmonic distortion is measured by a digital spectrum analyzer.
- Uncompressed FLAC files may not operate correctly.
- Audio in formats with high-sampling rates is down-sampled to 96 kHz or lower for playback.

*1 "Bluetooth Standby" means "STANDBY MODE" and "VIERA LINK".

When the other connected devices are turned off.

*2 Prospective communication distance.

Measurement environment: Temperature 25 °C/Height 1.0 m

Measure in "MODE 1"

Safety information for customers in the EU

English

Declaration of Conformity (DoC)

Hereby, "Panasonic Corporation" declares that this product is in compliance with the essential requirements and other relevant provisions of Directive 2014/53/EU.

Customers can download a copy of the original DoC to our RE products from our DoC server:

<http://www.ptc.panasonic.eu>

Contact to Authorised Representative:

Panasonic Marketing Europe GmbH, Panasonic Testing Centre, Winsbergring 15, 22525 Hamburg, Germany

Type of wireless	Frequency band	Maximum power (dBm e.i.r.p.)
Bluetooth® (The main unit)	2402-2480 MHz	10 dBm
2.4 GHz Wireless System (The main unit and the active subwoofer)	2401.35-2479.35 MHz	10 dBm

Ελληνικά

Δήλωση συμμόρφωσης (DoC)

Η "Panasonic Corporation" δηλώνει ότι το προϊόν αυτό είναι συμμορφωμένο προς τις βασικές απαιτήσεις και άλλες σχετικές διατάξεις της Οδηγίας 2014/53/ΕΕ.

Οι πελάτες μπορούν να κατεβάσουν ένα αντίγραφο του πρωτοτύπου DoC για τα RE προϊόντα μας από τον DoC server μας:

<http://www.ptc.panasonic.eu>

Επικοινωνήστε με τον Εξουσιοδοτημένο Αντιπροσωπώ μας:

Panasonic Marketing Europe GmbH, Panasonic Testing Centre, Winsbergring 15, 22525 Hamburg, Γερμανία

Τύπο ασύρματης	Ζώνη συχνοτήτων	Μέγιστη ισχύς (dBm e.i.r.p.)
Bluetooth® (The main unit)	2402-2480 MHz	10 dBm
2.4 GHz Wireless System (The main unit and the active subwoofer)	2401.35-2479.35 MHz	10 dBm

Português

Declaração de Conformidade (DoC)

Com o presente documento, a "Panasonic Corporation" declara que este produto se encontra em conformidade com os requisitos específicos e demais especificações referentes à Diretiva 2014/53/UE.

Os clientes podem baixar uma cópia da declaração de conformidade (DoC) para nossos produtos RE do Server DoC:

<http://www.ptc.panasonic.eu>

Contacto com um Representante Autorizado:

Panasonic Marketing Europe GmbH, Panasonic Testing Centre, Winsbergring 15, 22525 Hamburg, Alemanha

Tipo de ligação sem fios	Banda de frequência	Potência máxima (dBm e.i.r.p.)
Bluetooth® (The main unit)	2402-2480 MHz	10 dBm
2.4 GHz Wireless System (The main unit and the active subwoofer)	2401.35-2479.35 MHz	10 dBm

Magyar

Megfelelőségi Nyilatkozat (DoC)

Ezennel a "Panasonic Corporation" kijelenti, hogy a jelen termék kielégíti az 2014/53/EU Irányelv léfontosságú követelményeit és más vonatkozó rendelkezéseit.

A vásárlók letölthetik az RE termékek eredeti DoC másolatát a DoC szerverünkről:

<http://www.ptc.panasonic.eu>

A hivatalos képviselő elérhetősége:

Panasonic Marketing Europe GmbH, Panasonic Testing Centre, Winsbergring 15, 22525 Hamburg, Németország

Wireless típus	Frekvenciasáv	Maximális teljesítmény (dBm e.i.r.p.)
Bluetooth® (The main unit)	2402-2480 MHz	10 dBm
2.4 GHz Wireless System (The main unit and the active subwoofer)	2401.35-2479.35 MHz	10 dBm

Slovensky

Vyhlasenie o zhode (DoC)

"Panasonic Corporation" týmto vyhlasuje, že tento výrobok je v súlade so základnými požiadavkami a ďalšími príslušnými ustanoveniami smernice 2014/53/EU.

Zákazníci si môžu stiahnuť kópiu pôvodného DoC na naše RE výrobky z nášho servera DoC:

<http://www.ptc.panasonic.eu>

Kontakt na splnomocneného zástupcu:

Panasonic Marketing Europe GmbH, Panasonic Testing Centre, Winsbergring 15, 22525 Hamburg, Nemecko

Typ bezdrôtového pripojenia	Frekvencné pásmo	Maximálny výkon (dBm e.i.r.p.)
Bluetooth® (The main unit)	2402-2480 MHz	10 dBm
2.4 GHz Wireless System (The main unit and the active subwoofer)	2401.35-2479.35 MHz	10 dBm

Eesti keel

Vastavusdeklaratsioon (DoC)

Käesolevaga kinnitab "Panasonic Corporation", et see toode vastab direktiivi 2014/53/EL olulistele nõuetele ja teistele asjakohastele sätetele.

Kliendid saavad koopia meie RE toodetele kehtiva originaalvastavusdeklaratsiooni koopia alla laadida meie DoC-serverist:

<http://www.ptc.panasonic.eu>

Võtke ühendust volitatud esindajaga:

Panasonic Marketing Europe GmbH, Panasonic Testing Centre, Winsbergring 15, 22525 Hamburg, Saksamaa

Juhtmevaba seadme tüüp	Sagedusriba	Maksimaalne võimsus (dBm EIRP)
Bluetooth® (The main unit)	2402-2480 MHz	10 dBm
2.4 GHz Wireless System (The main unit and the active subwoofer)	2401.35-2479.35 MHz	10 dBm

Latviski

Atbilstības deklarācija (DoC)

Ar šo "Panasonic Corporation" paziņo, ka šis izstrādājums atbilst pamatprasībām un pārējiem Direktīvas 2014/53/ES noteikumiem.

Pircēji var lejupielādēt oriģinālo DoC kopiju mūsu RE

izstrādājums no mūsu DoC servera:

<http://www.ptc.panasonic.eu>

Lūdzam sazināties ar pilnvaroto parstāvi:

Panasonic Marketing Europe GmbH, Panasonic Testing Centre, Winsbergring 15, 22525 Hamburg, Vācija

Bezvadu tips	Frekvenču josta	Maksimālā jauda (dBm EIRP)
Bluetooth® (The main unit)	2402-2480 MHz	10 dBm
2.4 GHz Wireless System (The main unit and the active subwoofer)	2401.35-2479.35 MHz	10 dBm

Lietuviškai

Atitikties deklaracija (AD)

Bendrovė "Panasonic Corporation" patvirtina, kad šis gaminys atitinka direktyvos 2014/53/ES esminius reikalavimus ir kitas taikytinas nuostatas.

Mūsų RE gaminių originalios atitikties deklaracijos kopiją klientai gali atsisiųsti iš mūsų AD servero:

<http://www.ptc.panasonic.eu>

Įgaliojoto atstovo adresas:

Panasonic Marketing Europe GmbH, Panasonic Testing Centre, Winsbergring 15, 22525 Hamburg, Vokietija.

Bevielio ryšio tinklas	Dažnių diapazonas	Maksimali siuntimo galia (dBm e.i.r.p.)
Bluetooth® (The main unit)	2402-2480 MHz	10 dBm
2.4 GHz Wireless System (The main unit and the active subwoofer)	2401.35-2479.35 MHz	10 dBm

Slovensko

Izjava o skladnosti (DoC)

"Panasonic Corporation" v tem dokumentu izjavlja, da je izdelek v skladu z bistvenimi zahtevami in drugimi pomembnimi določbami Direktive 2014/53/EU. Stranka lahko naloži izvod izvirnega DoC o naših izdelkih RE s strežnika DoC. <http://www.ptc.panasonic.eu>

Naslov pooblaščenega predstavnika:

Panasonic Marketing Europe GmbH, Panasonic Testing Centre, Winsbergring 15, 22525 Hamburg, Nemčija

Vrsta brezžične povezave	Frekvenčni pas	Največja moč (dBm EIRP)
Bluetooth® (The main unit)	2402-2480 MHz	10 dBm
2.4 GHz Wireless System (The main unit and the active subwoofer)	2401.35-2479.35 MHz	10 dBm

Norsk

Samsvarserklæring (DoC)

"Panasonic Corporation" erklærer herved at dette produktet samsvarer med de grunnleggende kravene og andre relevante bestemmelser i direktivet 2014/53/EU.

Kundene kan laste ned en kopi av den originale samsvarserklæringen (DoC) for vårt RE utstyr fra vår DoC server: <http://www.ptc.panasonic.eu>

Kontaktinformasjon autorisert representant:

Panasonic Marketing Europe GmbH, Panasonic Testing Centre, Winsbergring 15, 22525 Hamburg, Tyskland

Type trådløs	Frekvensbånd	Maks. effekt (dBm e.i.r.p.)
Bluetooth® (The main unit)	2402-2480 MHz	10 dBm
2.4 GHz Wireless System (The main unit and the active subwoofer)	2401.35-2479.35 MHz	10 dBm

Български

Декларация за съответствие (DoC)

С настоящото "Panasonic Corporation" декларира, че този продукт е в съответствие с основните изисквания и други съответни разпоредби на Директива 2014/53/ЕС. Потребителите могат да свалят копия от оригиналните DoC към нашите продукти от типа RE от сървъра, на който се съхраняват DoC: <http://www.ptc.panasonic.eu>

Свържете се с нашия упълномощен представител:

Panasonic Marketing Europe GmbH, Panasonic Testing Centre, Winsbergring 15, 22525 Hamburg, Германия

Вид безжична връзка	Честотна лента	Максимална мощност (dBm e.i.r.p.)
Bluetooth® (The main unit)	2402-2480 MHz	10 dBm
2.4 GHz Wireless System (The main unit and the active subwoofer)	2401.35-2479.35 MHz	10 dBm

Român

Declarație de Conformitate (DoC)

"Panasonic Corporation" declară prin prezenta că acest produs este conform cu cerințele esențiale și alte prevederi relevante ale Directivei 2014/53/UE. Clienții pot descărca o copie a DoC-ului original al produselor noastre RE de la adresa noastră DoC din Internet: <http://www.ptc.panasonic.eu>

Contactați Reprezentantul Autorizat:

Panasonic Marketing Europe GmbH, Panasonic Testing Centre, Winsbergring 15, 22525 Hamburg, Germania

Tip de wireless	Interval de frecvență	Putere maximă (dBm e.i.r.p.)
Bluetooth® (The main unit)	2402-2480 MHz	10 dBm
2.4 GHz Wireless System (The main unit and the active subwoofer)	2401.35-2479.35 MHz	10 dBm

Hrvatski

Deklaracija o podobnosti (DoC)

Ovime „Panasonic Corporation“ izjavljuje da ovaj proizvod udovoljava osnovnim zahtjevima i ostalim relevantnim odredbama Direktive 2014/53/EU. Kupci mogu preuzeti kopiju originalne DoC za naše RE proizvode s našeg DoC poslužitelja:
<http://www.ptc.panasonic.eu>

Adresa ovlaštenog predstavništva:
Panasonic Marketing Europe GmbH, Panasonic Testing Centre,
Winsbergring 15, 22525 Hamburg, Njemačka

Vrsta bežične mreže	Frekvencijski pojas	Maksimalna snaga (dBm e.i.r.p.)
Bluetooth® (The main unit)	2402-2480 MHz	10 dBm
2.4 GHz Wireless System (The main unit and the active subwoofer)	2401.35-2479.35 MHz	10 dBm

Türkçe

Uygunluk Beyanı (DoC)

“Panasonic Corporation” bu belge ile bu ürünün 2014/53/EU Direkti'nin temel gerekliliklerine ve diğer ilgili hükümlerine uygun olduğunu beyan eder. Müşterilerimiz RE ürünlerimizle ilgili orijinal DoC belgesinin bir kopyasını DoC sunucumuzdan indirebilir:
<http://www.ptc.panasonic.eu>

Yetkili Temsilci ile temasa geçin:
Panasonic Marketing Europe GmbH, Panasonic Testing Centre,
Winsbergring 15, 22525 Hamburg, Almanya

Kablosuz türü	Frekans bandı	Maksimum güç (dBm e.i.r.p.)
Bluetooth® (The main unit)	2402-2480 MHz	10 dBm
2.4 GHz Wireless System (The main unit and the active subwoofer)	2401.35-2479.35 MHz	10 dBm

Safety information for customers in India

The specifications are exempted for any licensing requirement by Ministry of Communications and Information Technology, G.S.R. 45 (E), dated 28th January, 2005.

Safety information for customers in Norway

NORSK

ADVARSEL

Produkt

- For å redusere faren for brann, elektrisk støt eller skade på apparatet:
 - Utsett ikke produktet for regn, fukt, drypping eller sprut.
 - Ikke plasser objekter som er fylt med væske, som vaser, på apparatet.
 - Bruk det anbefalte tilbehøret.
 - Fjern ikke deksler.
 - Reparer ikke denne enheten selv, overlat service til kvalifisert servicepersonell.

Vekselstrømnett

- Nettstøpselet er trukket ut fra denne enheten. Installer denne enheten slik at nettstøpselet umiddelbart kan trekkes fra stikkontakten.

FORSIKTIG

Produkt

- Plasser ikke åpen ild, slik som levende lys, oppå apparatet.
- Dette apparatet er beregnet for bruk under moderate klimaforhold.

Plassering

- For å redusere faren for brann, elektrisk støt eller skade på apparatet:
 - Ikke plasser apparatet i en bokhylle, et innebygget kabinett eller et annet lukket sted. Pass på at produktet er godt ventilert.
 - Apparatets ventilasjonsåpninger må ikke dekkes til med aviser, duker, gardiner eller lignende.

Panasonic Warranty

1. Subject to the conditions of this warranty Panasonic or its Authorised Service Centre will perform necessary service on the product, without charge for parts or labour, if in the opinion of Panasonic the product is found to have a manufacturing defect within one (1) year or (12 months) (the "warranty period") from the date of purchase appearing on your purchase receipt.
2. This warranty only applies to Panasonic products purchased in Australia and sold by Panasonic Australia, it's Authorised Distributors, or Dealers, and only where the products are used and serviced within Australia or its territories. Warranty cover only applies to the services that are carried out by a Panasonic Authorised Service Centre and only if valid proof of purchase is presented when the warranty service is requested.
3. This warranty only applies if the product has been installed and/or used in accordance with the manufacturer's recommendations (as noted in the operating instructions) under normal use and reasonable care (in the opinion of Panasonic). The warranty does not cover damage, malfunction or failure resulting from use of incorrect voltages, incorrect installation, accident, misuse, neglect, build-up of dirt or dust, abuse, maladjustment of customer controls, mains supply problems, thunderstorm activity, infestation by insects or vermin, tampering or repair by unauthorised persons (including unauthorised alterations), exposure to abnormally corrosive conditions, or any foreign object or matter having entered the product.
4. This warranty does not cover the following items unless the fault or defect existed at the time of purchase:
 - (a) Consumable parts
 - (b) Cosmetic parts
 - (c) Worn or damaged parts
 - (d) Information stored on Hard Disk Drives, Optical Discs, USB Devices, SD Cards, Tapes
 - (e) DTV reception issues caused by TV Aerial / Cabling / Wall socket(s)
5. Some products may be supplied with Ethernet connection hardware. The warranty is limited on such products and will not cover:
 - (a) Internet and or DLNA connection / setup related problems
 - (b) Access fees and or charges incurred for internet connection
 - (c) Incompatible software or software not specifically stipulated in the product operations manual; and
 - (d) Any indirect or consequential costs associated with the incorrect use or misuse of the hardware, its connection to the internet or any other device.
6. To claim warranty service, when required, you should:
 - Contact Panasonic's Customer Care Centre on 132 600 for Service Centre information.
 - Confirm the opening and acceptance times with the Authorised Service centre that you choose.
 - Then send or take the product to a Panasonic Authorised Service Centre together with your proof of purchase receipt.
 - Any freight and insurance costs associated with the transport of the product to and/or from your nearest Authorised Service Centre must be arranged and paid for by you.
7. The warranties hereby conferred do not extend to, and exclude, any costs associated with the installation, de-installation or re-installation of a product, including costs related to the mounting, de-mounting or remounting of any screen, (and any other ancillary activities), delivery, handling, freighting, transportation or insurance of the product or any part thereof or replacement of and do not extend to, and exclude, any damage or loss occurring by reason of, during, associated with, or related to such installation, de-installation, re-installation or transit.

Panasonic Authorised Service Centres are located in major metropolitan areas and most regional centres of Australia, however, coverage will vary dependant on product. For advice on exact Authorised Service Centre locations for your product, please telephone our Customer Care Centre on 132600 or visit our website and use the Service Centre Locator.

In addition to your rights under this warranty, Panasonic products come with consumer guarantees that cannot be excluded under the Australian Consumer Law. If there is a major failure with the product, you can reject the product and elect to have a refund or to have the product replaced or if you wish you may elect to keep the goods and be compensated for the drop in value of the goods. You are also entitled to have the product repaired or replaced if the product fails to be of acceptable quality and the failure does not amount to a major failure.

If there is a major failure in regard to the product which cannot be remedied then you must notify us within a reasonable period by contacting the Panasonic Customer Care Centre. If the failure in the product is not a major failure then Panasonic may choose to repair or replace the product and will do so in a reasonable period of time from receiving notice from you.

THIS WARRANTY CARD AND THE PURCHASE DOCKET (OR SIMILAR PROOF OF PURCHASE) SHOULD BE RETAINED BY THE CUSTOMER AT ALL TIMES

If you require assistance regarding warranty conditions or any other enquiries, please visit the Panasonic Australia website www.panasonic.com.au or contact by phone on **132 600**
If phoning in, please ensure you have your operating instructions available.

Panasonic Australia Pty. Limited

ACN 001 592 187 ABN 83 001 592 187
 1 Innovation Road, Macquarie Park NSW 2113
www.panasonic.com.au

PRO-031-F11 Issue: 5.0

23-01-2018

For the United Kingdom and Ireland customers

Sales and Support Information

Customer Communications Centre

- For customers within the UK: 0344 844 3899
- For customers within Ireland: 01 289 8333
- Monday–Friday 9:00 am – 5:00 pm (Excluding public holidays).
- For further support on your product, please visit our website:
www.panasonic.co.uk

Direct Sales at Panasonic UK

- Order accessory and consumable items for your product with ease and confidence by phoning our Customer Communications Centre Monday–Friday 9:00 am – 5:00 pm (Excluding public holidays).
- Or go on line through our Internet Accessory ordering application at www.pas-europe.com.
- Most major credit and debit cards accepted.
- All enquiries transactions and distribution facilities are provided directly by Panasonic UK.
- It couldn't be simpler!
- Also available through our Internet is direct shopping for a wide range of finished products. Take a browse on our website for further details.



Manufactured by: Panasonic Corporation
Kadoma, Osaka, Japan
Importer for Europe: Panasonic Marketing Europe GmbH
Panasonic Testing Centre
Winsbergring 15, 22525 Hamburg, Germany



Panasonic Corporation
Web Site: <http://www.panasonic.com>

