

FOR INSTALLATION BY QUALIFIED SERVICE PERSONNEL ONLY

# CONVERSION KIT INSTRUCTIONS

## Commercial Electric Water Heaters



**⚠ CAUTION**

TEXT PRINTED OR OUTLINED IN RED CONTAINS INFORMATION RELATIVE TO YOUR SAFETY. PLEASE READ THOROUGHLY BEFORE ATTEMPTING ANY CONVERSION.

# FOREWORD

---

The purpose of this manual is to explain how to change the voltage and wattage of an A. O. Smith commercial electric water heater by changing the elements. This manual is not intended to explain the rebuilding of electric water heaters in the field.

Addition of heating elements or subtraction of heating elements in the field is not approved by Underwriters Laboratories, Inc., and therefore, should not be attempted.

The heater to be converted and the appropriate conversion for the heater must be found on the same page of this manual. Read the instructions contained on pages 7 thru 11 before attempting any conversion.

## SAFETY

Be sure to disconnect water heater from electrical supply before working on or near the electrical system of the heater. Never touch electrical components with wet hands or when standing in water.

## REQUIRED ABILITY

CONVERSION OF ANY WATER HEATER LISTED IN THIS MANUAL REQUIRES ABILITY EQUIVALENT TO THAT OF A LICENSED ELECTRICAL TRADESMAN

# CONTENTS

---

CONVERSION ALLOWED ON	PAGE	CONVERSION INSTRUCTIONS	PAGE
Six-Gallon Models with One Element, 120/277/208/240/480 Volts, One Phase, Two Wire C-2 Circuit.....	3	INSTRUCTIONS.....	3
Models with One Element, 120/277/208/240/480 Volts, One Phase, Two-Wire C-2 Circuit (Except Six-Gallon) ...	4	I. INTRODUCTION .....	7
Models with Two Elements, 120/277 Volts, Single Phase, Non-Simultaneous or Simultaneous Four-Wire A-8 Circuit.....	5	II. HEATER PREPARATION.....	7
Models with Two Elements, 208/240/480 Volts, One- or Three-Phase, Non-Simultaneous or Simultaneous Four-Wire A-8 Circuit.....	6	III. KW CONVERSION (ELEMENT REPLACEMENT) ...	7
		IV. VOLTAGE CONVERSION.....	7
		V. PHASE CONVERSION .....	7
		VI. SIMULTANEOUS CONVERSION .....	8
		VII. FINAL ASSEMBLY .....	9
		VIII. MISCELLANEOUS INFORMATION.....	11

# CONVERSION MATERIALS

---

1. Screw Plug Element Remover: 1-1/2" deep well socket and ratchet.
2. Screwdrivers: Two required, one #2 phillips and one slotted screwdriver.
3. Conversion kit: Includes conversion instructions, replacement electrical element(s), conversion kit label, caution label.

# Six-Gallon Models with One Element, 120/277/208/240/480 Volts, One Phase, Two Wire C-2 Circuit

## INSTRUCTIONS

1. Find the voltage and KW of the required heater.
2. On the same line, move to the right until you are in the column of the kit number required.
3. Order the corresponding kit.

See pages 7 thru 11 for detailed instructions.

**Table 1. Kits for Six-Gallon Models with One Element 120-480 Volts, Single Phase,  
Two-Wire C-2 Circuit**

Total Voltage	Element kW Input	Kit Wattage	Kit Number
120	1.5	1500	100109461
	2.0	2000	100109462
	2.5	2500	100109463
	3.0	3000	100109464
277	1.5	1500	100109465
	2.0	2000	100109466
	2.5	2500	100109467
	3.0	3000	100109468
208	1.5	1500	100109472
	2.0	2000	100109473
	2.5	2500	100109474
	3.0	3000	100109475
240	1.5	1500	100109481
	2.0	2000	100109482
	2.5	2500	100109483
	3.0	3000	100109484
480	2.5	2500	100109491
	3.0	3000	100109492

**CHECK ALL WATER AND ELECTRICAL CONNECTIONS FOR TIGHTNESS**



# Models with One Element, 120/277/208/240/480 Volts, Single Phase, Two-Wire C-2 Circuit (Except Six-Gallon)

## INSTRUCTIONS

1. Find the voltage and kW of the required heater.
2. On the same line, move to the right until you are in the column of kit number required.
3. Order to corresponding kit.

See pages 7 thru 11 for detailed conversion instructions.

**Table 2. Kits for Models with One Element, 120-480 Volts, Single Phase,  
Two-Wire C-2 Circuit**

Total Voltage	Element KW Input	Kit Wattage	Number
120	1.5	1500	100109461
	2.0	2000	100109462
	2.5	2500	100109463
	3.0	3000	100109464
277	1.5	1500	100109465
	2.0	2000	100109466
	2.5	2500	100109467
	3.0	3000	100109468
	4.0	4000	100109469
	4.5	4500	100109470
208	6.0	6000	100109471
	1.5	1500	100109472
	2.0	2000	100109473
	2.5	2500	100109474
	3.0	3000	100109475
	3.5	3500	100109476
	4.0	4000	100109477
	4.5	4500	100109478
240	5.0	5000	100109479
	6.0	6000	100109480
	1.5	1500	100109481
	2.0	2000	100109482
	2.5	2500	100109483
	3.0	3000	100109484
	3.5	3500	100109485
	4.0	4000	100109486
	4.5	4500	100109487
	5.0	5000	100109488
480	5.5	5500	100109489
	6.0	6000	100109490
	2.5	2500	100109491
	3.0	3000	100109492
	4.0	4000	100109493
	4.5	4500	100109494
480	5.0	5000	100109495
	6.0	6000	100109496

**CHECK ALL WATER AND ELECTRICAL CONNECTIONS FOR TIGHTNESS**



# Models with Two Elements, 120/277 Volts, Single Phase, with Non-Simultaneous or Simultaneous Four-Wire A-8 Circuit

## INSTRUCTIONS

1. Find the voltage and kW of the required heater.
2. On the same line, move to the right until you are in the column of kit number required.
3. Order to corresponding kit.

See pages 7 thru 11 for detailed conversion instructions.

**Table 3. Kits for Models with Two Elements,  
120/277 Volts, One Phase, with Non-Simultaneous or Simultaneous,  
Four-Wire A-8 Circuit**

Voltage	Total KW Input		Element Wattage	Kit Number
	Simultaneous Operation	Non-Simultaneous Operation		
120	3	1.5	1500	100109451
	4	2.0	2000	100109452
	5	2.5	2500	100109453
	*	3.0	3000	100109521
277	3	1.5	1500	100109454
	4	2.0	2000	100109455
	5	2.5	2500	100109456
	6	3.0	3000	100109457
	8	4.0	4000	100109458
	9	4.5	4500	100109459
	12	6.0	6000	100109460

\* Cannot convert to Simultaneous Operation Mode.

**CHECK ALL WATER AND ELECTRICAL CONNECTIONS FOR TIGHTNESS**



# Models with Two Elements, 208/240/480 Volts, One- or Three-Phase, Simultaneous or Non-Simultaneous Four-Wire A-8 Circuit

## INSTRUCTIONS

1. Find the voltage and KW of the required heater.
2. On the same line, move to the right until you are in the column of kit number required.
3. Order to corresponding kit.

See pages 7 thru 11 for detailed conversion instructions.

**Table 4. Kits for Two-Element Models, 208/240/480 Volts  
One- or Three Phase, Simultaneous or Non-Simultaneous  
Four-Wire A-8 Circuit**

Voltage	Total KW Input	Element Wattage	Kit Number
208	2.0	1000	100109497
	3.0	1500	100109498
	4.0	2000	100109499
	5.0	2500	100109500
	6.0	3000	100109501
	7.0	3500	100109502
	8.0	4000	100109503
	9.0	4500	100109504
	*10	5000	100109505
240	3.0	1500	100109506
	4.0	2000	100109507
	5.0	2500	100109508
	6.0	3000	100109509
	7.0	3500	100109510
	8.0	4000	100109511
	9.0	4500	100109512
	10.0	5000	100109513
	11.0	5500	100109514
480	5.0	2500	100109515
	6.0	3000	100109516
	8.0	4000	100109517
	9.0	4500	100109518
	10.0	5000	100109519
	12.0	6000	100109520
* Only available on 3Ph Simultaneous			

**CHECK ALL WATER AND ELECTRICAL CONNECTIONS FOR TIGHTNESS**



# CONVERSION INSTRUCTIONS

---

## REQUIRED ABILITY

**CONVERSION OF ANY WATER HEATER LISTED IN THIS MANUAL REQUIRES ABILITY EQUIVALENT TO THAT OF A LICENSED ELECTRICAL TRADESMAN**

### I. INTRODUCTION

Satisfying a customer order for an electric heater from inventory may require modification to the kW input, the voltage, or the phase. Conversions may involve revision to 1, 2, or all 3 of these electrical characteristics.

### II. HEATER PREPARATION

The heater should be placed in a well lit area. Complete removal of the shipping carton is not required. Locate front of carton (opposite side of heater identification label). Cut a three-sided flap into front of carton, cut should be on top, bottom and right side approximately 4" from carton edges. Leave the left side of the flap as a hinge. Cuts made 4" from the edge of carton will permit proper reclosure when conversion is completed.

Remove the two control panel screws on the water heater door(s).

To expose elements, fold insulation from right to left. DO NOT RIP INSULATION. Remove the personnel protector(s). Take care not to damage protector.

### III. KW CONVERSION (ELEMENT REPLACEMENT)

- A. Remove wires from one element at a time.
- B. Remove element from heater using 1-1/2" deep well socket and ratchet. Return the elements to appropriate bin.
- C. Open the appropriate conversion kit and remove the element(s). Check each element head to ensure correct voltage and wattage.
- D. Install the new element with a 1-1/2" socket wrench. A new "O" ring gasket should be installed on each element. Screw element into fitting until it seats. Tighten 1/2" to 3/4" turn with wrench.
- E. Rewire the element. Screw terminals must be snug, however, caution must be exercised. Overtightening may break the terminal block, requiring replacement of the element.
- F. Repeat steps A thru E for all other elements being replaced.

### IV. VOLTAGE CONVERSION

- A. DO NOT CHANGE THE GROUND CONNECTIONS.

### V. PHASE CONVERSION

#### A. THREE PHASE TO SINGLE PHASE

1. Disconnect black wire from terminal L-3.
2. Connect black wire to terminal L-2 (with blue wire).
3. Incoming power will be connected to terminals L-1 and L-2 at job site.

## VI. SIMULTANEOUS CONVERSION

A. Disconnect red wire from power terminal “J”.

B. Reconnect red wire to terminal L1, along with yellow wire on terminal block.

\*See diagram below. Note: Steps V and VI pertain only to conversions on page 7 of this manual.

### **CAUTION**

Recheck all terminals for tightness, proper wiring per schematic, and neatness of wiring. Heater should be no less than factory constructed quality and appearance.

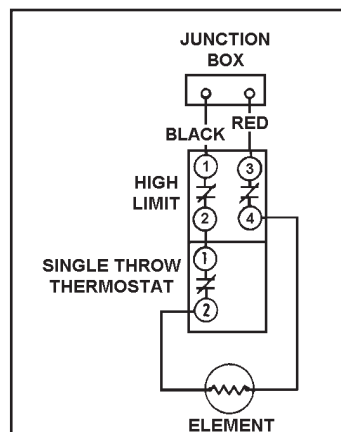

Figure 1. Two-Wire C-2 Circuit for Single-Element Heaters

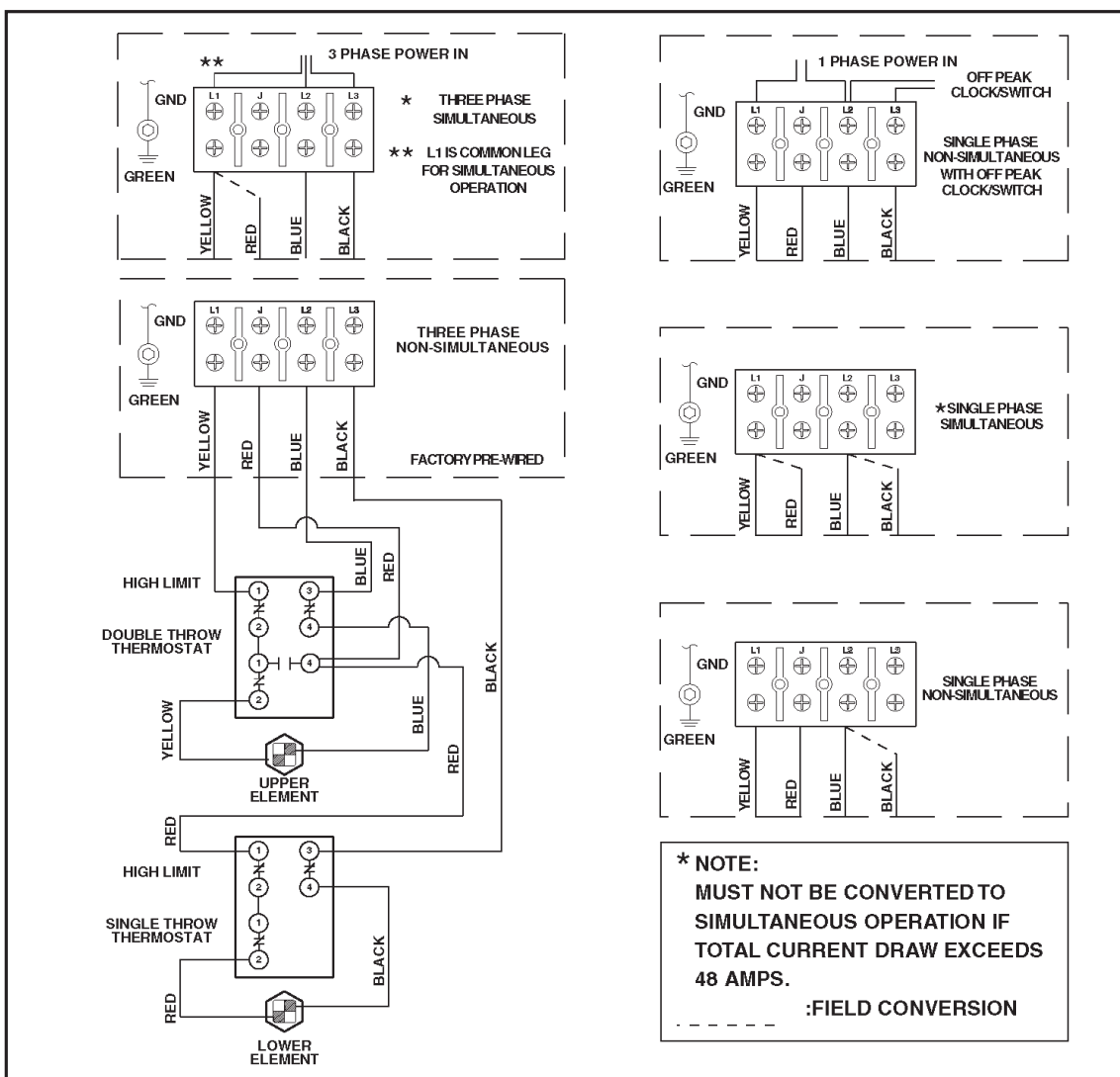

Figure 2. Four-Wire A-8 Circuit for Dual-Element Heater

## VII. FINAL ASSEMBLY

### A. CONTROL COVER(S).

Replace personnel protector(s). Unfold insulation blanket. Cover all elements and thermostats as originally constructed. Replace door and tighten the two screws.

### B. RATING PLATE MODIFICATION OF DUAL ELEMENTS ELECTRIC WATER HEATERS.

Following is an example of the standard rating plate supplied on the front of dual element commercial electric water heaters.

<b>COMMERCIAL STORAGE TANK WATER HEATER</b>						
MODEL NUMBER		SERIAL NUMBER		ITEM ID / PART NUMBER		
VOLTS - AC	PHASE	WATTS UPPER	WATTS LOWER	CIRCUIT	CAPACITY US GALS	MAX. WORKING PRESSURE
TOTAL WATTS CONNECTED INTERLOCK		SIMULTANEOUS		CITY OF NEW YORK DEPT. OF BUILDING MEA		

Figure 3. Rating Plate

VOLTS - AC		PHASE	WATTS UPPER	WATTS LOWER
X	X	X	X	X
TOTAL WATTS CONNECTED INTERLOCK		SIMULTANEOUS		
X		X		

The volts, phase, and watts information of the rating plate must be modified by covering them with the rating plate overlay label provided in the conversion kit. Be sure the new ratings on the label match the conversion you have just completed.

Figure 4. Rating Plate Overlay

Peel off the back of label and paste over the area as shown on the revised rating plate below.

<b>COMMERCIAL STORAGE TANK WATER HEATER</b>						
MODEL NUMBER		SERIAL NUMBER		ITEM ID / PART NUMBER		
VOLTS - AC	PHASE	WATTS UPPER	WATTS LOWER	CIRCUIT	CAPACITY US GALS	MAX. WORKING PRESSURE
X	X	X	X			
TOTAL WATTS CONNECTED INTERLOCK		SIMULTANEOUS		CITY OF NEW YORK DEPT. OF BUILDING MEA		
X		X				

Figure 5. Rating Plate

C. RATING PLATE MODIFICATION OF SINGLE ELEMENT ELECTRIC WATER HEATERS.

The following is an example of the standard rating plate supplied on the front of single-element electric water heaters.

<b>COMMERCIAL STORAGE TANK WATER HEATER</b>			
MODEL NUMBER	SERIAL NUMBER	ITEM ID / PART NUMBER	
VOLTS - AC	PHASE	WATTS UPPER	WATTS LOWER
CIRCUIT		CAPACITY US GALS	MAX. WORKING PRESSURE
TOTAL WATTS CONNECTED INTERLOCK		CITY OF NEW YORK DEPT. OF BUILDING MEA	
SIMULTANEOUS			

Figure 6. Rating Plate

				
VOLTS - AC	PHASE	WATTS UPPER	WATTS LOWER	TOTAL WATTS CONNECTED
X	X	X	X	X

The volts, phase, and watts information of the rating plate must be modified by covering them with the rating plate overlay label provided in the conversion kit. Be sure the new ratings on the label match the conversion you have just completed.

Figure 7. Rating Plate Overlay

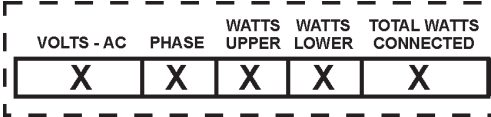
Peel off the back of the label and paste over the area as shown on the revised rating plate below.

<b>HOUSEHOLD STORAGE TANK WATER HEATER</b>			
MODEL NUMBER	SERIAL NUMBER	ITEM ID / PART NUMBER	
VOLTS - AC	PHASE	WATTS UPPER	WATTS LOWER
CIRCUIT		TOTAL WATTS CONNECTED	CAPACITY US GALS
CITY OF NEW YORK DEPT. OF BUILDING MEA			

Figure 8. Rating Plate



**D. CAUTION LABEL**

Peel off back of caution label and place as near to rating plate as possible, taking care not to cover any existing labels.

**E. CARTON IDENTIFICATION**

Using a black magic marker, cross out heater identification on carton as appropriate. In bold letters, write new electrical specifications on carton, matching those on the revised rating plate.

**F. SHIPPING CARTON**

Close and tape the cardboard flap on the front of carton.



**NEVER OPERATE THE HEATER WITHOUT FILLING WITH WATER PER THE FILLING INSTRUCTIONS. FAILURE TO DO SO WILL DAMAGE INTERNAL PARTS.**

**VIII. MISCELLANEOUS INFORMATION**

**Table 5. FULL LOAD CURRENT IN AMPERES**

KW Input	Single (1) Phase					Three (3) Phase		
	120V	208V	240V	277V	480V	208V	240V	480V
1.5	12.5	7.2	6.3	5.4	N/A	N/A	N/A	N/A
2.0	16.7	9.6	8.3	7.2	N/A	8.3/4.8	N/A	N/A
2.5	20.8	12.0	10.4	9.0	5.2	N/A	N/A	N/A
3.0	25.0	14.4	12.5	10.8	6.3	12.5/7.2	10.8/6.3	N/A
3.5	N/A	16.8	14.6	N/A	N/A	N/A	N/A	N/A
4.0	N/A	19.2	16.7	14.4	8.3	16.7/9.6	14.4/8.3	N/A
4.5	N/A	21.6	18.8	16.2	9.4	N/A	N/A	N/A
5.0	N/A	24.0	20.8	N/A	10.4	20.8/12.0	18.0/10.4	9.0/5.2
5.5	N/A	N/A	22.9	N/A	N/A	N/A	N/A	N/A
6.0	N/A	28.8	25.0	21.7	12.6	25.0/14.4	21.7/12.5	10.8/6.3
7.0	N/A	33.6	29.2	N/A	N/A	29.1/16.8	25.3/14.6	N/A
8.0	N/A	38.6	33.4	N/A	16.6	33.3/19.2	28.9/16.7	14.4/8.3
9.0	N/A	43.2	37.6	N/A	18.8	37.5/21.6	32.5/18.8	16.2/9.4
10.0	N/A	48.0	41.6	N/A	20.8	41.6/24.0	36.1/20.8	18.0/10.4
11.0	N/A	N/A	45.8	N/A	N/A	46.0/26.5	39.7/22.9	N/A
12.0	N/A	N/A	N/A	43.3	25.2	N/A	43.5/25.0	21.7/12.5

