

Operator's Manual

CRAFTSMAN®

55cc 2-Cycle

GASOLINE CHAIN SAW

Model No. 316.350840

INCREDI-PULL™
UNBELIEVABLE STARTING EASE™

with **MAXFIRE**  **IGNITION™**



CAUTION: Before using this product, read this manual and follow all safety rules and operating instructions.

- SAFETY
- ASSEMBLY
- OPERATION
- MAINTENANCE
- PARTS LIST

Sears, Roebuck and Co., Hoffman Estates, IL 60179, U.S.A.
Visit our website: www.sears.com/craftsman

9096-31B204 date(12/04)

TABLE OF CONTENTS

Warranty	Page 2	Maintenance and Repair	Pages 15 - 21
Safety Rules	Pages 3 - 8	Troubleshooting	Page 22
Oil and Fuel Information	Page 9	Specifications	Page 23
Starting/Stopping Instructions	Pages 10-12	Repair Parts	Pages 24
Operation	Pages 13 - 14		

WARRANTY STATEMENT

ONE YEAR LIMITED WARRANTY ON CRAFTSMAN GAS CHAIN SAW

For one year from the date of purchase, when this Chain Saw is used and maintained according to the operator's manual, Sears will repair any defect in material or workmanship free of charge.

This warranty excludes the bar, chain, spark plug and air filter, which are expendable parts that can wear out from normal use in less than two years.

If this Chain Saw is used for commercial or rental purposes, this warranty applies for only 30 days from the date of purchase.

WARRANTY SERVICE IS AVAILABLE BY RETURNING THIS CHAIN SAW TO THE NEAREST SEARS STORE OR SEARS PARTS & SERVICE CENTER IN THE UNITED STATES.

This warranty gives you specific legal rights, and you may also have other rights which vary from state to state.

Sears, Roebuck and Co., Dept. 817WA, Hoffman Estates, IL 60179

CALIFORNIA PROPOSITION 65 WARNING

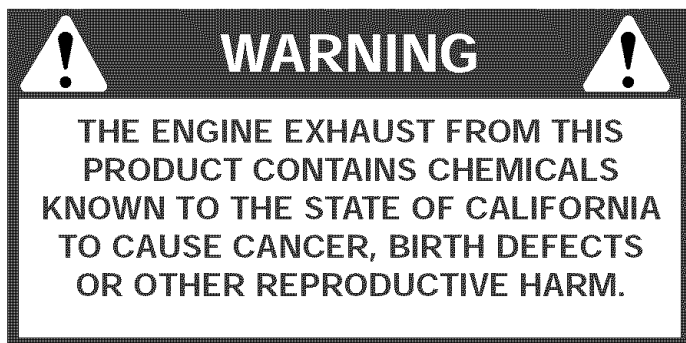

SPARK ARRESTOR NOTE

NOTE: For users on U.S. Forest Land and in the states of California, Maine, Oregon and Washington. All U.S. Forest Land and the state of California (Public Resources Codes 4442 and 4443), Oregon and Washington require, by law that certain internal combustion engines operated on forest brush and/or grass-covered areas be equipped with a spark arrestor, maintained in effective working order, or the engine be constructed, equipped and maintained for the prevention of fire. Check with your state or local authorities for regulations pertaining to these requirements. Failure to follow these requirements could subject you to liability or a fine. **This unit is factory equipped with a spark arrestor.** If it requires replacement, ask a Sears or other qualified service dealer to install the **Spark Arrestor Kit.**

RULES FOR SAFE OPERATION

The purpose of safety symbols is to attract your attention to possible dangers. The safety symbols, and their explanations, deserve your careful attention and understanding. The safety warnings do not by themselves eliminate any danger. The instructions or warnings they give are not substitutes for proper accident prevention measures.

SYMBOL	MEANING
--------	---------

	<p>SAFETY ALERT: Indicates danger, warning or caution. Attention is required in order to avoid serious personal injury. May be used in conjunction with other symbols or pictographs.</p>
--	--

NOTE: Advises you of information or instructions vital to the operation or maintenance of the equipment.

Read the Operator's Manual(s) and follow all warnings and safety instructions.

Failure to do so can result in serious injury to the operator and/or bystanders.

SYMBOL	MEANING
--------	---------

	<p>DANGER: Failure to obey a safety warning will result in serious injury to yourself or to others. Always follow the safety precautions to reduce the risk of fire, electric shock and personal injury.</p>
---	---

	<p>WARNING: Failure to obey a safety warning can result in injury to yourself and others. Always follow the safety precautions to reduce the risk of fire, electric shock and personal injury.</p>
---	---

	<p>CAUTION: Failure to obey a safety warning may result in property damage or personal injury to yourself or to others. Always follow the safety precautions to reduce the risk of fire, electric shock and personal injury.</p>
---	---

• IMPORTANT SAFETY INSTRUCTIONS •

READ ALL INSTRUCTIONS PLAN AHEAD

	<p>WARNING: If correctly used, the chain saw is a quick, easy to handle and efficient tool; if used improperly or without the due precautions it could become a dangerous tool. For pleasant and safe work, always strictly comply with the safety rules that are contained in this manual.</p>
--	--

- Read the instructions carefully. Be familiar with the controls and proper use of the unit.
- Do not operate this unit when tired, ill or under the influence of alcohol, drugs or medication.
- Children must not operate the unit. Teens must be accompanied and guided by an adult.
- Only responsible individuals who are familiar with the instructions may operate the chain saw (no one under the age of 16). Provide parental supervision at all times.
- Secure hair above shoulder length. Do not wear loose clothing or jewelry; they can get caught in moving parts.
- Inspect the unit before use. Replace all damaged parts prior to starting. Make sure the unit is in original operating condition before starting.
- Know the controls and know how to stop the chain saw quickly.

- Carry the chain saw with the engine stopped, the guide bar and saw chain to the rear, and the muffler away from your body.
- When transporting your chain saw, use the appropriate guide-bar scabbard (sheath).
- Wear protective gear. Always use steel-toed safety footwear with non-slip soles; snug-fitting clothing; heavy-duty non-slip gloves; eye protection such as non-fogging, vented goggles or face screen; an approved safety hard hat; and hearing protection. Regular users should have hearing checked regularly as chain saw noise can damage hearing.

OPERATE YOUR SAW SAFELY

- Do not operate a chain saw that is damaged, not calibrated properly or not fully assembled. Always replace chain, bar, chain brake, and other parts immediately if damage occurs.
- Do not apply excess force to the chain saw at the end of the cut. You may lose control of the unit when the cut has been completed.
- Keep all parts of your body away from the chain when the engine is running.
- Never start or run the unit inside a closed room or building. Operate this unit only in a well ventilated outdoor area.
- Use the unit only in daylight or good artificial light.

RULES FOR SAFE OPERATION

- Avoid accidental starting. Be in the starting position whenever pulling the starter rope. The operator and unit must be in a stable position while starting. See Starting/Stopping Instructions.
- Before you start the engine, make sure the area around the saw is clear. Never try to start the saw when the guide bar is engaged in a cut.
- Do not start cutting until you have a clear work area, secure footing, and a planned retreat path from the falling tree.
- Do not operate a chain saw that is damaged, improperly adjusted, or not completely and securely assembled. Be sure that the saw's chain stops moving when the throttle control trigger is released.
- Shut off the engine before setting the chain saw down.
- Use extreme caution when cutting small-sized brush and saplings because slender material may catch the chain saw and whip towards you or cause you to lose control.
- When cutting a limb that is under tension, be alert for springback so that you will not be struck when the tension in the wood fibers is released.
- Do not cut through nails, rods in the tree, railroad ties or pallets. Inspect a tree that you are going to cut for foreign objects that could cause injury or damage to your chain saw.
- After striking a foreign object, stop the engine and thoroughly inspect for damage. Repair as necessary.
- Keep the handles dry, clean and free of the oil/fuel mixture.
- We do not recommend using the chain saw in a tree or on a ladder.

MAINTAIN YOUR SAW IN GOOD WORKING ORDER

- All chain saw service, other than the items listed in this instruction manual maintenance instructions, should be performed by a Sears or other qualified service dealer.
- Make sure all fasteners are in place and secure.
- Unauthorized replacement parts or the removal of safety devices may cause damage to the unit and possible injury to the operator or bystanders. Use only Craftsman accessories and replacement parts as recommended. Never modify your saw.
- When not in use, saw should be stored in a dry, highly secure location away from children.
- When storing saw use a scabbard or carrying case.

HANDLE FUEL WITH CAUTION

- Do not smoke while handling fuel or while operating the saw.
- Always eliminate all sources of sparks or flame in areas where fuel is mixed or poured.
- Always mix and pour fuel in an outdoor area and use an approved, marked container for all fuels. Always wipe up all fuel spills before starting saw.

- When a chain saw is being used, a fire extinguisher should be available.
- Always move at least 10 feet (3 meters) from fueling site before starting saw.
- When re-fueling, turn the engine off and allow the saw to cool in a non-combustible area, do not place on dry leaves, straw, paper, etc. Slowly remove fuel cap and refuel unit.
- Always store the unit and fuel in a cool, dry, well-ventilated space where fuel vapors cannot reach sparks or open flames from water heaters, electric motors or switches, furnaces, etc.
- All chain saw service, other than the items listed in this instruction manual maintenance instructions, should be performed by a Sears or other qualified service dealer.
- Use the right tool. Only use this chain saw for its intended purpose, to cut wood.
- Never touch the chain or attempt to service the saw while the engine is running. Make sure all moving parts have stopped. Allow the chain saw to cool, as the chain can be hot.
- Check the bar and chain at frequent intervals for proper adjustment. Make sure the bar and chain are properly tightened and sharpened. Visually inspect for damage. Repair any damage before restarting or operating the chain saw.



WARNING: KICKBACK may occur when the nose or tip of the guide bar touches an object, or when the wood closes in and pinches the saw chain in the cut. Tip contact in some cases may cause a lightning-fast reverse reaction, kicking the guide bar up and back towards the operator. Pinching the saw chain along the top of the guide bar may push the guide bar rapidly back toward the operator. Either of these reactions may cause you to lose control of the saw, which could result in serious personal injury. Do not rely exclusively upon the safety devices built into your saw. As a chain saw user, you should take several steps to keep your cutting jobs free from accident or injury.

KICKBACK SAFETY PRECAUTIONS

- With a basic understanding of kickback, you can reduce or eliminate the element of surprise. Sudden surprise contributes to accidents. Be alert to the potential for kickback at all times.
- Keep a good firm grip on the saw with both hands, the right hand on the rear handle and the left hand on the front handle, when the engine is running. Use a firm grip with thumbs and fingers encircling the chain saw handles. A firm grip will help you reduce kickback and maintain control of the saw. Don't let go.

RULES FOR SAFE OPERATION

- Make sure that the area in which you are cutting is free from obstructions. Do not let the nose of the guide bar contact a log, branch, fence, or any other obstruction that could be hit while you are operating the saw.
- Always cut with the engine running at full speed. Fully squeeze the throttle trigger and maintain a steady cutting speed.
- Use only the correct original equipment manufacturer replacement bars, chains and other parts and accessories. These are available from a Sears or other qualified service dealer. Use of any unauthorized parts or accessories could lead to serious injury to the user, or damage to the unit, and will void your warranty.
- Follow the manufacturer's sharpening and maintenance instructions for the saw chain.
- Use only the replacement guide bars and low kickback chains specified for your saw to avoid injury.
- Watch for shifting logs or other forces that could pinch or fall into chain.
- Always have saw at full speed when entering a previous cut. Always use caution when entering a previous cut.
- Do not start a cut using the tip of the saw.

OTHER SAFETY PRECAUTIONS

- Do not operate a chain saw with one hand! Serious injury to the operator, helpers, bystanders, or any combination of these persons may result from one-handed operation. A chain saw is intended for two-handed use.
- Do not operate a chain saw if you are fatigued.
- Use safety footwear; snug-fitting clothing; protective gloves; and eye, hearing, and head protection devices.
- Do not allow other persons to be near the chain saw when starting or cutting with the chain saw. Keep bystanders and animals out of the work area.
- Do not remove, damage or de-activate any of the safety devices. Never use a damaged, modified, or improperly repaired or assembled chain saw. Check their proper operation regularly. Only use bars and chains of the length indicated in the table herein.
- Never carry out operations or repairs on your own that are other than routine maintenance as listed in this manual.
- Use caution when felling a tree. Make sure you have planned an escape path when felling, and keep all bystanders away.
- Be alert; stop the machine if anyone enters the cutting area, which is usually 3 to 4 feet around the operator.
- Use caution when working in a crew to avoid injury to a fellow worker who may enter the cutting area.
- Only loan your saw to experienced users who are completely familiar with saw operation and correct use. Give other users this manual, which they should read before

using the saw.

- Shut off the engine before setting down the saw. Do not leave the engine running unattended.
- Never store the unit, with fuel in the tank, inside a building where fumes may reach an open flame or spark.
- Allow the engine to cool before storing or transporting the chain saw over long distances. For example, let the engine cool before placing the chain saw in an automobile. Also, be sure to secure the unit while transporting.
- Store the unit in a dry area, locked up, located up high and located out of the reach of children to prevent unauthorized use or damage.
- Never douse or squirt the unit with water or any other liquid. Keep handles dry, clean and free from debris. Clean after each use.
- Keep these instructions. Refer to them often and use them to instruct other users. If you loan someone this unit, also loan them the instructions.
- Do not use the unit in the rain, in a storm or in inclement weather.

FUEL SAFETY

- Store fuel only in containers specifically designed and approved for the storage of such materials.
- Always stop the engine and allow it to cool before filling the fuel tank. Never remove the cap of the fuel tank, or add fuel, when the engine is hot. Never operate the unit without the fuel cap securely in place. Loosen the fuel tank cap slowly to relieve any pressure in the tank.
- Add fuel in a clean, well-ventilated outdoor area where there are no sparks or flames. Slowly remove the fuel cap only after stopping engine. Do not smoke while fueling or mixing fuel. Wipe up any spilled fuel from the unit immediately.



WARNING: Gasoline is highly flammable, and its vapors can explode if ignited. Take the following precautions:





- Avoid creating a source of ignition for spilled fuel. Do not start the engine until fuel vapors dissipate.
- Move the unit at least 30 feet (9.1 m) from the fueling source and site before starting the engine. Do not smoke. Keep sparks and open flames away from the area while adding fuel or operating the unit.

SAVE THESE INSTRUCTIONS

RULES FOR SAFE OPERATION

SAFETY AND INTERNATIONAL SYMBOLS

This operator's manual describes safety and international symbols and pictographs that may appear on this product. Read the operator's manual for complete safety, assembly, operating and maintenance and repair information.

SYMBOL	MEANING	SYMBOL	MEANING
	<ul style="list-style-type: none"> • SAFETY ALERT SYMBOL <p>Indicates danger, warning, or caution. May be used in conjunction with other symbols or pictographs.</p>		<ul style="list-style-type: none"> • ON/OFF CONTROL ON / START / RUN
	<ul style="list-style-type: none"> • READ OPERATOR'S MANUAL <p>WARNING: Read the Operator's Manual(s) and follow all warnings and safety instructions. Failure to do so can result in serious injury to the operator and/or bystanders.</p>		<ul style="list-style-type: none"> • ON/OFF CONTROL OFF OR STOP
	<ul style="list-style-type: none"> • WEAR EYE, HEARING AND HARDHAT PROTECTION <p>WARNING: Thrown objects and loud noise can cause severe eye injury and hearing loss. Wear eye protection meeting ANSI Z87.1-1989 standards and ear protection when operating this unit. Wear a hard hat. Use a full face shield when needed.</p>		<ul style="list-style-type: none"> • GUIDE BAR <p>WARNING: Contact of the guide bar tip with any object should be avoided. Tip contact may cause the guide bar to move suddenly upward and backward, which may cause serious injury.</p>
	<ul style="list-style-type: none"> • UNLEADED FUEL <p>Always use clean, fresh unleaded fuel.</p>		<ul style="list-style-type: none"> • USE BOTH HANDS <p>Always use both hands while operating the chain saw. Never use only one hand to operate the saw.</p>
	<ul style="list-style-type: none"> • OIL <p>Refer to operator's manual for the proper type of oil.</p>		<ul style="list-style-type: none"> • RED CHOKE LEVER POSITIONS <p>1 • FULL Choke Position</p> <p>2 • PARTIAL Choke Position</p> <p>3 • RUN Position</p>

RULES FOR SAFE OPERATION

KNOW YOUR SAW

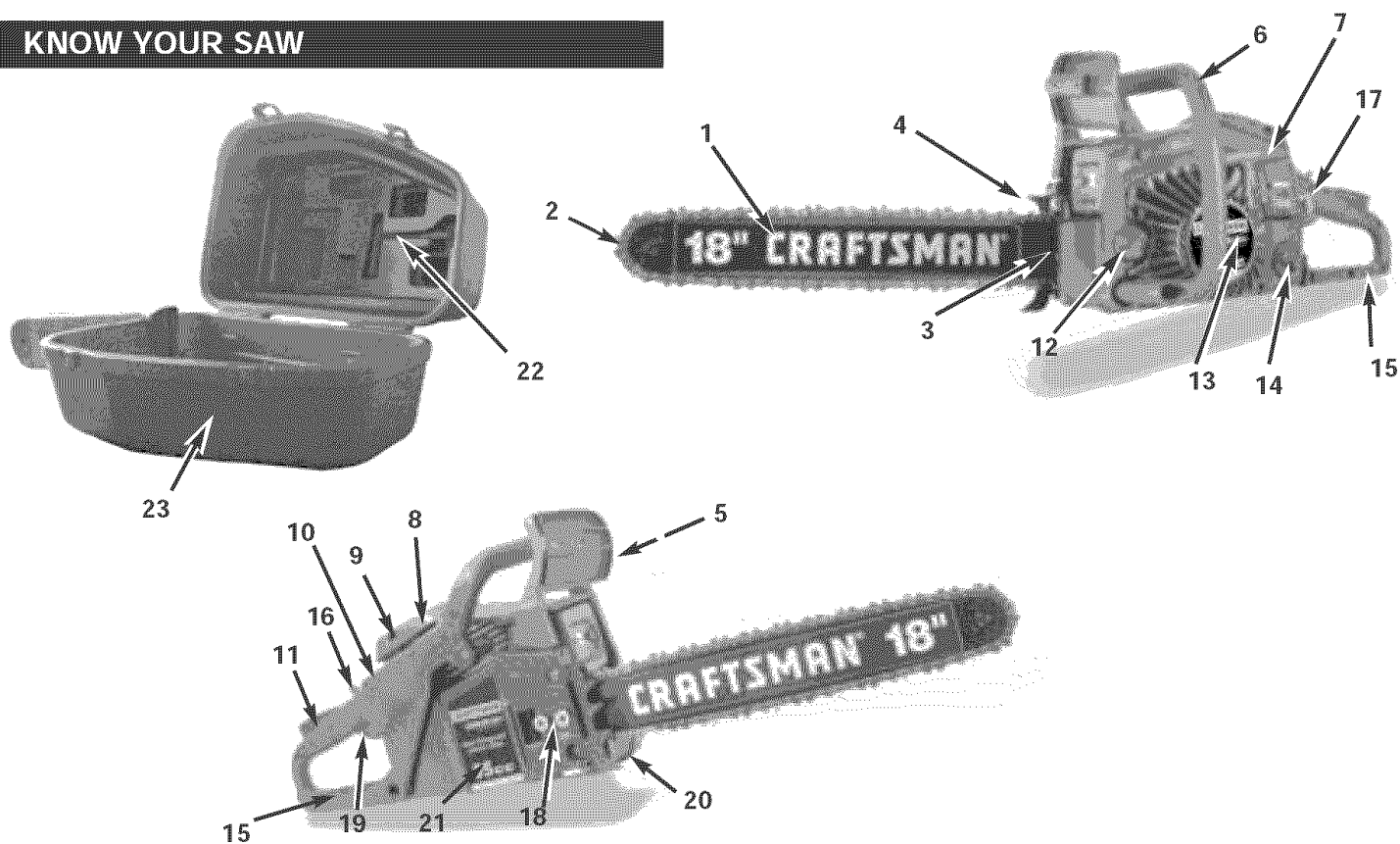

CHAIN SAW COMPONENTS

1. GUIDE BAR
2. SAW CHAIN
3. SAW CHAIN ADJUSTMENT SCREW
4. SPARK ARRESTER SCREEN
5. CHAIN BRAKE® LEVER / HAND GUARD
6. FRONT HANDLE
7. STARTER HANDLE
8. SPARK PLUG
9. AIR CLEANER COVER
10. STOP SWITCH
11. SAFETY TRIGGER
12. BAR OIL RESEVOIR CAP
13. STARTER COVER
14. FUEL TANK CAP
15. REAR HANDLE / BOOT LOOP
16. THROTTLE LATCH
17. RED CHOKE LEVER
18. BAR RETAINING NUTS
19. THROTTLE / TRIGGER
20. CHAIN CATCHER
21. CHAIN BRAKE® COVER
22. MULTI-PURPOSE TOOL
23. CARRY CASE

SAFETY FEATURES

2. LOW KICKBACK SAW CHAIN helps significantly reduce kickback, or the intensity of kickback, due to specially designed depth gauges and guard links.
3. CHAIN SAW ADJUSTMENT SCREW It is normal for a new chain saw chain to stretch after the first 30 minutes of use. Check the tension of the chain regularly to ensure the best performance, see SAW CHAIN ADJUSTMENT under MAINTENANCE AND REPAIR INSTRUCTIONS.
5. CHAIN BRAKE® LEVER / HAND GUARD protects the operator's left hand in the event it slips off the front handle while saw is running.
CHAIN BRAKE® is a safety feature designed to reduce the possibility of injury due to kickback by stopping a moving saw chain in milliseconds. It is activated by the CHAIN BRAKE® lever
10. STOP SWITCH immediately stops the engine when pushed up. Stop switch must be pushed down to start or restart engine.
11. SAFETY TRIGGER prevents accidental acceleration of the engine. Throttle trigger (19) cannot be squeezed unless the safety trigger is depressed.
17. RED CHOKE LEVER aids in starting the engine.
19. THROTTLE TRIGGER controls engine speed.
20. CHAIN CATCHER reduces the danger of injury in the event saw chain breaks or derails during operation. The chain catcher is designed to intercept a whipping chain.

RULES FOR SAFE OPERATION

KICKBACK SPECIFICS

	<p>WARNING: Kickback can lead to dangerous loss of control of the chain saw and result in serious or fatal injury to the saw operator or to anyone standing close by. Always be alert. Rotational kickback and pinch-kickback are major chain saw operational dangers and the leading cause of most accidents.</p>
--	---

KICKBACK may occur when the NOSE or TIP of the guide bar touches an object, or when wood closes in and pinches the saw chain in the cut.

Tip contact in some cases may cause a lightning-fast reverse reaction, kicking the guide bar up and back toward the operator.

Any of these reactions may cause you to lose control of the saw, which could result in serious personal injury.

Rotational Kickback

Rotational Kickback can occur when the moving chain contacts an object at the upper tip of the guide bar. This contact can cause the chain to dig into the object, which stops the chain for an instant. The result is a lightning fast, reverse reaction which kicks the guide bar up and back toward the operator.

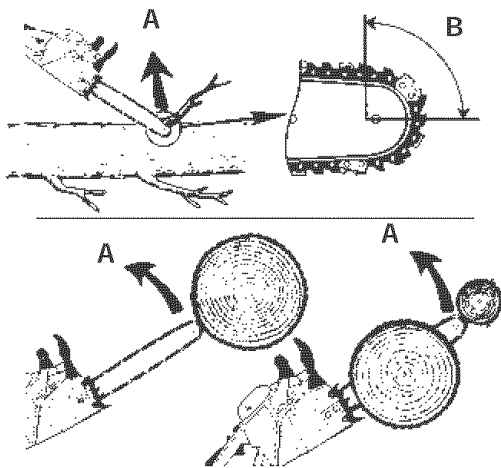

A = Kickback path
B = Kickback reaction zone

Fig. 1

KICKBACK SPECIFICS

Pinch Kickback

Pinch kickback can occur when the saw chain is pinched along the bottom or top of the guide bar.

When pinched on the bottom of the guide bar, it may pull the saw forward, away from the operator

When pinched along the top of the guide bar, it may push the guide bar rapidly back toward the operator.

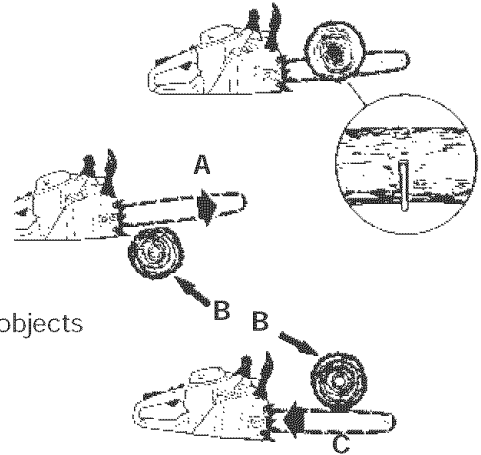

A = Pull
B = Solid objects
C = Push

Fig. 2

OIL AND FUEL INFORMATION

OIL AND FUEL MIXING INSTRUCTIONS

Old and/or improperly mixed fuel are the main reasons for the unit not running properly. Be sure to use fresh (less than 60 days old) clean unleaded fuel. Follow the instructions carefully for the proper fuel/oil mixture.

Definition of Blended Fuels

Today's fuels are often a blend of gasoline and oxygenates such as ethanol, methanol, or MTBE (ether). Alcohol-blended fuel absorbs water. As little as 1% water in the fuel can make fuel and oil separate and lead to formation of acids during storage. When using alcohol-blended fuel, use fresh fuel.

Using Blended Fuels

If you choose to use a blended fuel, or its use is unavoidable, follow recommended precautions:

- Always use the fresh fuel mix explained in your operator's manual
- Always shake the fuel mix before fueling the unit
- Drain the tank and run the engine dry before storing the unit

Using Fuel Additives

The bottle of 2-cycle oil that came with your unit contains a fuel additive which will help inhibit corrosion and minimize the formation of gum deposits. It is recommended that you use our 2-cycle oil with this unit.



If unavailable, use a good 2-cycle oil designed for air-cooled engines along with a fuel additive, such as STA-BIL® Gas Stabilizer or an equivalent. Add 0.8 oz. (23 ml.) of fuel additive per gallon of fuel according to the instructions on the container. NEVER add fuel additives directly to the unit's fuel tank.

	CAUTION: For proper engine operation and maximum reliability, pay strict attention to the oil and fuel mixing instructions on the 2-cycle oil container. Using improperly mixed fuel can severely damage the engine.
---	---

To Obtain Correct Fuel Mix:

Thoroughly mix the proper ratio of 2-cycle engine oil with unleaded gasoline in a separate fuel can. Use a 40:1 fuel/oil ratio. Do not mix them directly in the engine fuel tank. See the table below for specific gas and oil mixing ratios.

NOTE: One gallon (3.8 liters) of unleaded gasoline mixed with one 3.2 oz. (95 ml.) bottle of 2-cycle oil makes a 40:1 fuel/oil ratio.

	+	
UNLEADED GAS		2 CYCLE OIL
1 GALLON US (3.8 LITERS)		3.2 FL. OZ. (95 ml)
1 LITER		25 ml

MIXING RATIO - 40:1

	WARNING: Gasoline is extremely flammable. Ignited vapors may explode. Always stop the engine and allow it to cool before filling the fuel tank. Do not smoke while filling the tank. Keep sparks and open flames at a distance from the area.
---	--

	WARNING: Remove fuel cap slowly to avoid injury from fuel spray. Never operate the unit without the fuel cap securely in place.
---	--

	WARNING: Add fuel in a clean, well ventilated outdoor area. Wipe up any spilled fuel immediately. Avoid creating a source of ignition for spilled fuel. Do not start the engine until fuel vapors dissipate.
---	---

NOTE: Dispose of the old fuel/oil mix in accordance to Federal, State and Local regulations.

STARTING/STOPPING INSTRUCTIONS



WARNING: Operate this unit only in a well-ventilated outdoor area. Carbon monoxide exhaust fumes can be lethal in a confined area.



WARNING: Never operate the saw without the bar and chain properly installed.

BEFORE STARTING ENGINE

WARNING: Be sure to read the *Oil and Fuel Information Section* of this manual before you begin. If you do not understand the oil and fuel information, do not attempt to fuel your unit. For more information contact your local Sears service center at 1-800-4-MY-HOME®.

GUIDE BAR AND CHAIN OIL

The bar and chain require lubrication. The chain oiler provides continuous lubrication to the chain and guide bar. Be sure to fill the bar oil tank when you fill the fuel tank. (Capacity = 6.8 fl. oz.). Lack of oil will quickly ruin the bar and chain. Too little oil will cause overheating with smoke coming from the chain and discoloration of the bar. For maximum guide bar and chain life, we recommend you use Craftsman chain saw bar oil. If Craftsman bar oil is not available, you may use a good grade SAE 30 oil until you are able to obtain the Craftsman brand. The oil output is automatically metered during operation. Your saw will use approximately one tank of bar oil for every tank of fuel mix. Always fill the bar oil tank when you fill the fuel tank.

FUELING THE ENGINE

WARNING: Remove fuel cap slowly when refueling.

This engine is certified to operate on unleaded gasoline. Before operation, gasoline must be mixed with a good quality synthetic 2-cycle air-cooled engine oil. We recommend Craftsman brand synthetic oil. Mix gasoline and oil at a ratio of 40:1. 40:1 ratio is obtained by mixing 3.2 ounces of oil with 1 gallon of unleaded gasoline. Included with this saw is a 3.2 ounce container of oil. Pour the entire contents of this container into one gallon of gasoline to achieve the proper fuel mixture. DO NOT use automotive oil or boat oil. These oils will cause engine damage. When mixing fuel, follow the instructions printed on the oil container. Once oil is added to the gasoline, shake container momentarily to assure that the fuel is thoroughly mixed. Always read and follow the safety rules relating to fuel before fueling your unit.

IMPORTANT:

Experience indicates that alcohol blended with fuels (called gasohol or using ethanol or methanol) can attract moisture which leads to separation and formation of acids during storage. Acidic gas can damage the fuel system of an engine when in storage. To avoid engine problems, the fuel system should be emptied before storage for 30 days or longer. Drain the gas tank, start the engine and let it run until fuel lines and carburetor are empty. Use fresh fuel next season. Never use engine or carburetor cleaner products in the fuel tank or permanent damage can occur. See STORAGE instructions for additional information.

CHAIN BRAKE

Be sure the chain brake is disengaged by pulling the front hand guard back toward the front handle as far as possible. The chain brake must be disengaged before cutting with the saw.

WARNING: The chain brake must not move when the engine runs at idle speed. If the chain brake moves at idle speed, refer to CARBURETOR ADJUSTMENT in this manual. Avoid contact with the muffler. A hot muffler can cause serious burns.

IMPORTANT POINTS TO REMEMBER

When pulling the starter rope, do not use the full extent of the rope as this can cause the rope to break. Do not let starter rope snap back. Hold the handle and let the rope rewind slowly. For cold weather starting, start the unit at FULL CHOKE; allow the engine to warm up before squeezing the throttle trigger.

DO NOT attempt to cut material with the choke/fast idle lever in the FULL CHOKE position.

STARTING/STOPPING INSTRUCTIONS

STOPPING INSTRUCTIONS

1. Release the trigger and allow the engine to return to the idle speed.
2. Move the STOP switch up to the STOP position (Fig. 4).

NOTE: For emergency stopping, push the lever of the chain brake lever/hand guard (C) forward and move the STOP switch up (Fig. 3, 4).

STARTING A COLD ENGINE

To be sure to add the correctly mixed fuel to the fuel tank (A) and to add bar and chain oil to the oil tank (B). Make sure the chain brake is disengaged (C) before starting the unit.

1. Slide the STOP switch down (Fig. 4). The **red choke lever** (H) has 3 positions: Positions 1, 2 and 3 (Fig. 6).
2. Fully press and release the primer bulb (G) 10 times, slowly. Some amount of fuel should be visible in the primer bulb (Fig. 5). If you can't see fuel in the bulb, press and release the bulb as many times as it takes before you can see fuel in it.
3. Move the **red choke lever** (H) to Position 1 (Fig. 6).

NOTE: This unit will not run with the lever in Position 1.

4. Place the saw on a firm flat surface. Hold saw firmly as shown (Fig. 7).

NOTE: The unit uses the **INCREDI-PULL™** starting system with **MAX FIRE IGNITION™**, which significantly reduces the effort required to start the engine. You must pull the starter rope out far enough to hear the engine attempt to start. There is no need to pull the rope briskly-- there is no harsh resistance when pulling. Be aware that this starting method is vastly different from (and much easier than) what you may be used to.

5. Hold down safety trigger (E) and squeeze the throttle trigger (D). With thumb, press down on the throttle latch (F). Release trigger (D) first. This will lock the throttle into wide open position (Fig. 3). Pull the rope with a controlled and steady motion 4 times.
6. Then move the **red choke lever** (H) to Position 2, being sure to keep the throttle trigger locked. Hold saw firmly and pull rope until saw starts. This could take 4 more pulls.
7. Let the saw warm up for 10 seconds. Depress and release throttle trigger (D) for idle.
8. Move **red choke lever** (H) to Position 3. If engine fails to start, repeat these instructions. If engine does start, begin chain brake test described on next page.
9. If unit idles roughly, there is an idle adjustment access hole (L)(Fig. 8). Using a Phillips or slotted screwdriver, turn screw 1/4 to 1/2 turn clockwise (to the right). Unit should then idle properly (Fig. 9).

NOTE: If chain turns while idling - turn screw back to the left until chain stops and unit continues to idle.

STARTING A WARM ENGINE

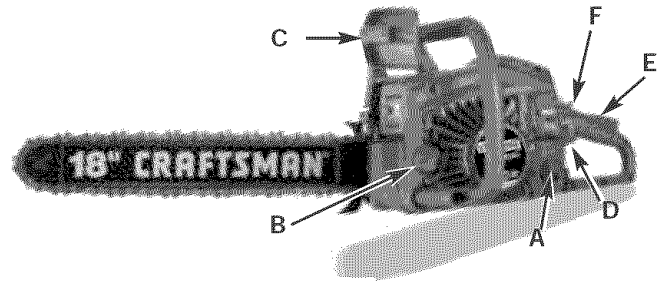

Fig. 3

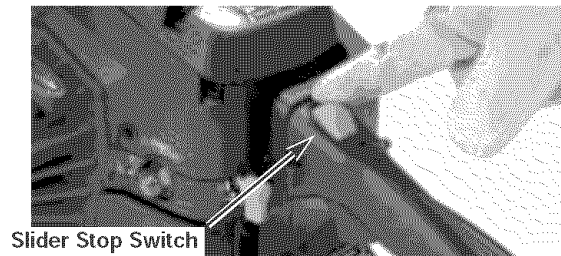

Fig. 4



Fig. 5

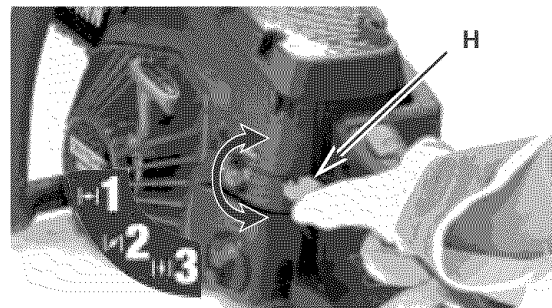

Fig. 6

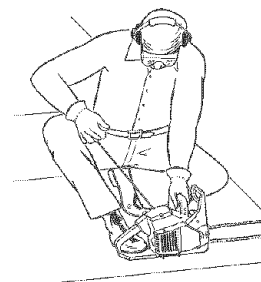

Fig. 7

STARTING/STOPPING INSTRUCTIONS



WARNING: Activate the CHAIN BRAKE® slowly and deliberately. Keep the chain from touching anything; don't let the saw tip forward.



WARNING: If chain does not stop, turn engine off and take your unit to the nearest Authorized Service Center for service.

CHAIN BRAKE TEST

1. Place saw on a clear, firm, flat surface.
2. With the chain brake pulled back to the disengaged position, start the engine.
3. Grasp the rear handle (A) with your right hand (Fig. 10).
4. With your left hand, hold the front handle (B) [not Chain Brake® lever (C)] firmly (Fig. 10).
5. Squeeze the throttle trigger to 1/3 throttle, then immediately engage the Chain Brake® lever by pushing forward (C) (Fig. 10).
6. Chain should stop abruptly. When it does, immediately release the throttle/trigger.
7. If Chain Brake® functions properly, turn the engine off and return the Chain Brake® to the DISENGAGED position.

Chain Lubrication

Adequate lubrication of the saw chain is essential at all times to minimize friction with the guide bar. Never starve the bar and chain of oil. Running the saw with too little oil will decrease cutting efficiency, shorten saw chain life, cause rapid dulling of chain, and cause excessive wear of bar from overheating. Too little oil is evidenced by smoke, bar discoloration or pitch build-up.

Automatic Oiler

Your chain saw is equipped with an automatic gear driven oiler system. The oiler automatically delivers the proper amount of oil to the bar and chain. As the engine speed increases, so does the oil flow to the bar pad. The amount of oil flowing to the bar and chain may be changed by turning the adjustment screw (D) with a small slotted screwdriver as shown in Fig. 11. Turn the screw clockwise to DECREASE oil flow and counterclockwise to INCREASE the flow.

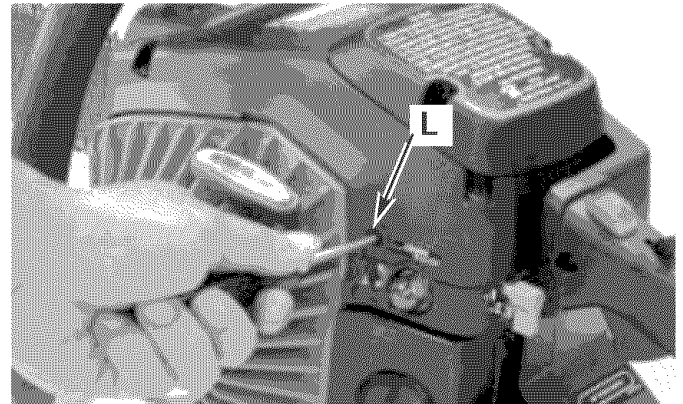

Fig. 8

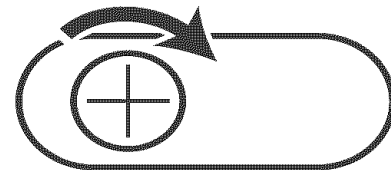

Fig. 9

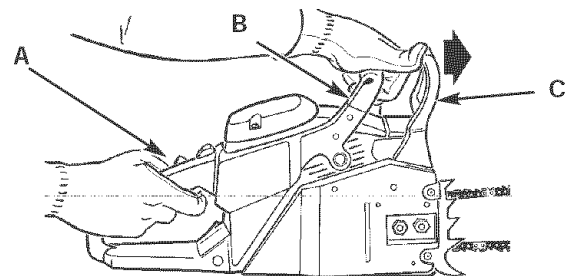

Fig. 10

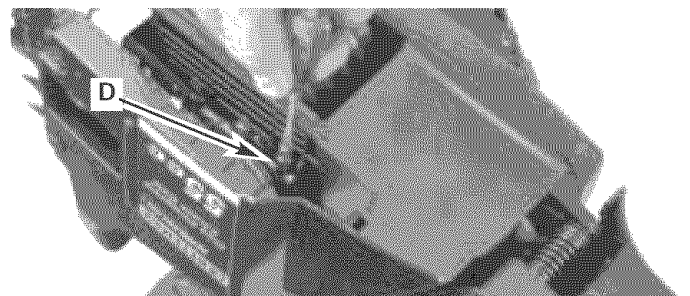



Fig. 11

OPERATING INSTRUCTIONS

FELLING

Felling is the term for cutting down a tree. Small trees up to 6-7 inches (15-18cm) in diameter are usually cut in a single cut. Larger trees require notch cuts. Notch cuts determine the direction the tree will fall.

	WARNING: A retreat path (A) should be planned and cleared as necessary before cuts are started. The retreat path should extend back and diagonally to the rear of the expected line of fall, as illustrated in Fig. 12.
--	--

	CAUTION: If felling a tree on sloping ground, the chain saw operator should keep on the uphill side of the terrain, as the tree is likely to roll or slide downhill after it is felled.
--	--

NOTE: Direction of fall (B) is controlled by the notching cut. Before any cuts are made, consider the location of larger branches and natural lean of the tree to determine the way the tree will fall.

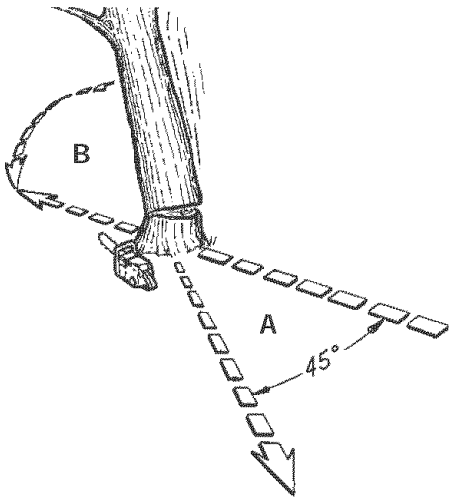



Fig. 12

	WARNING: Do not cut down a tree during high or changing winds or if there is a danger to property. Consult a tree professional. Do not cut down a tree if there is a danger of striking utility wires; notify the utility company before making any cuts.
--	--

Normally felling consists of 2 main cutting operations, notching (C) and making the felling cut (D) (Fig. 13).

Start making the upper notch cut (C) on the side of the tree facing the felling direction (E). Be sure you don't make the lower cut too deep into the trunk (Fig. 13).

The notch (C) should be deep enough to create a hinge (F) of sufficient width and strength. The notch should be wide enough to direct the fall of the tree for as long as possible (Fig. 13).

	WARNING: Never walk in front of a tree that has been notched. When felling, keep at least 2 tree lengths away from your fellow workers.
---	--

Make the felling cut (D) from the other side of the tree and 1.5 - 2.0 inches (3-5 cm) above the edge of the notch (C) (Fig. 13).

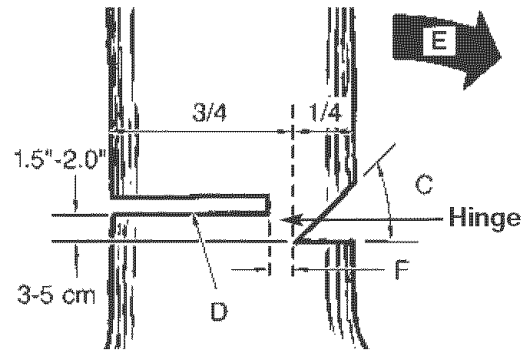

Fig. 13

Never saw completely through the trunk. Always leave a hinge. The hinge guides the tree. If the trunk is completely cut through, control over the felling direction is lost.

	WARNING: Before making the final cut, always recheck the area for bystanders, animals or obstacles.
--	--

Insert a wedge or felling lever in the cut well before the tree becomes unstable and starts to move. This will prevent the guidebar from binding in the felling cut if you have misjudged the falling direction. Make sure no bystanders have entered the range of the falling tree before you push it over.

Felling Cut:

1. Use wooden or plastic wedges (G) to prevent binding the bar or chain (H) in the cut. Wedges also control felling (Fig. 14).
2. When diameter of wood being cut is greater than the bar length, make 2 cuts as shown (Fig. 15).

	WARNING: As the felling cut gets close to the hinge, the tree should begin to fall. When tree begins to fall, remove saw from cut, stop engine, put chain saw down, and leave area along retreat path (Fig. 12).
---	---

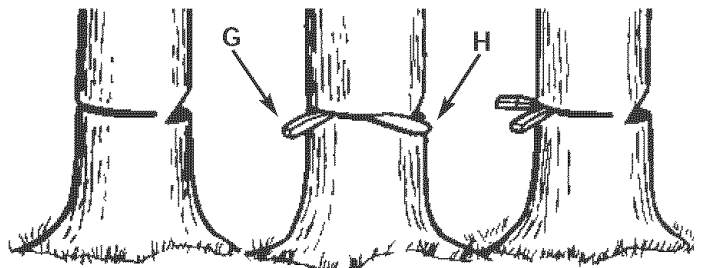

Fig. 14

OPERATING INSTRUCTIONS

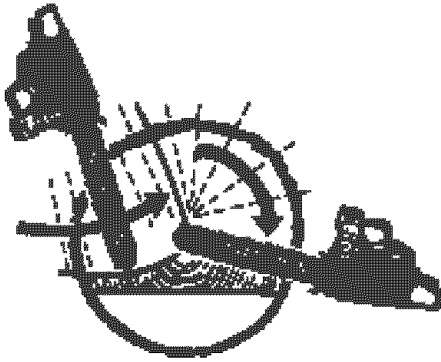

Fig. 15

LIMBING

Limbing a tree is the process of removing the branches from a fallen tree. Do not remove supporting limbs (A) until after the log is bucked (cut) into lengths (Fig. 16). Branches under tension should be cut from the bottom up to avoid binding the chain saw.

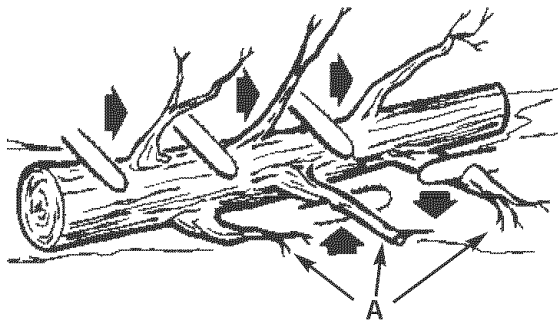

Fig. 16

	WARNING: Never cut tree limbs while standing on a tree trunk.
--	--

BUCKING

Bucking is cutting a fallen log into lengths. Make sure you have a good footing and stand uphill of the log when cutting on sloping ground. If possible, the log should be supported so that the end to be cut off is not resting on the ground. If the log is supported at both ends and you must cut in the middle, make a downward cut halfway through the log and then make the undercut. This will prevent the log from pinching the bar and chain. Be careful that the chain does not cut into the ground when bucking as this causes rapid dulling of the chain.

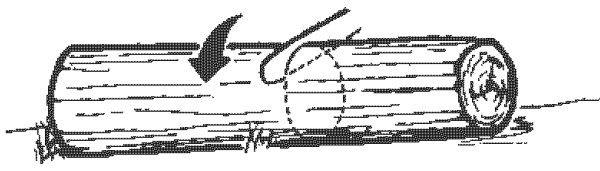

Fig. 17

When bucking on a slope, always stand on the uphill side.

1. Log supported along entire length: Cut from top (overbuck), being careful to avoid cutting into the ground (Fig. 17).
2. Log supported on 1 end: First, cut from bottom (underbuck) 1/3 diameter of log to avoid splintering. Second, cut from above (overbuck) to meet first cut and avoid pinching (Fig. 18).
3. Log supported on both ends: First, overbuck 1/3 diameter of log to avoid splintering. Second, underbuck to meet first cut and avoid pinching (Fig. 19).

NOTE: The best way to hold a log while bucking is to use a sawhorse. When this is not possible, the log should be raised and supported by the limb stumps or by using supporting logs. Be sure the log being cut is securely supported.

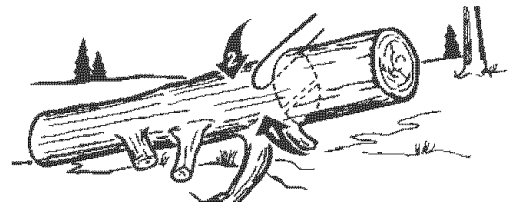

Fig. 18

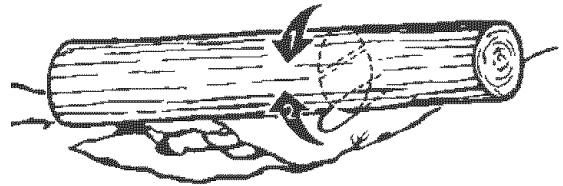

Fig. 19

BUCKING USING A SAWHORSE

For personal safety and ease of cutting, the correct position for vertical bucking is essential (Fig. 20).

- A. Hold the saw firmly with both hands and keep the saw to the right of your body while cutting.
- B. Keep the left arm as straight as possible.
- C. Keep weight on both feet.

	CAUTION: While the saw is cutting, be sure the chain and bar are being properly lubricated.
--	--

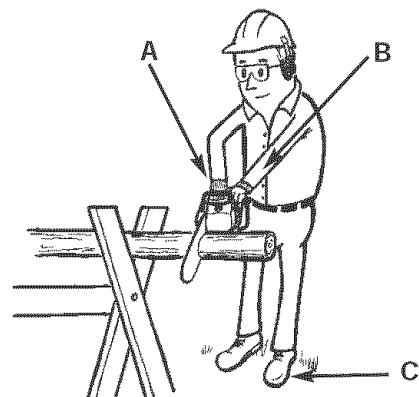

Fig. 20

MAINTENANCE AND REPAIR INSTRUCTIONS

MAINTENANCE SCHEDULE

Perform these required maintenance procedures at the frequency stated in the table. These procedures should also be a part of any seasonal tune-up.

NOTE: Maintenance, replacement, or repair of the emission control devices and system may only be performed by a Sears or other qualified service dealer.

NOTE: Maintenance, replacement, or repair of the emission control devices and system may be performed by a Sears or other qualified service dealer.



WARNING: To prevent serious injury, never perform maintenance or repairs with unit running. Always service and repair a cool unit. Disconnect the spark plug wire to ensure that the unit cannot start.

A good preventive maintenance program of regular inspection and care will increase life and improve performance of your chain saw. This maintenance checklist is a guide for such a program.

Cleaning, adjustment, and part replacement may be required, under certain conditions, at more frequent intervals than those indicated.

CUSTOMER RESPONSIBILITY

MAINTENANCE CHECKLIST		AFTER EACH USE	HOURS OF OPERATION	
ITEM	BEFORE EACH USE		10	20
CHECK FOR LOOSE SCREWS/ NUTS/BOLTS	✓			
CLEAN OR REPLACE THE AIR FILTER			✓	
REPLACE SPARK PLUG REPLACE OIL / FUEL FILTER			✓	
CLEAN, INSPECT SPARK PLUG ARRESTOR SCREEN / MUFFLER			✓	
CHECK GUIDE BAR AND CHAIN OIL, FUEL HOSES	✓			
CLEAN UNIT AND INSPECT DECALS		✓		
CHECK CHAIN BRAKE® COMPONENTS		✓		
CLEAN GUIDE BAR GROOVE			✓	
CHECK FOR DAMAGED / WORN PARTS	✓			
CHECK CHAIN TENSION	✓			
CHECK CHAIN SHARPNESS	✓			
LUBRICATE SPROCKET TIP		✓		
CHECK FUEL MIXTURE	✓			

MAINTENANCE AND REPAIR INSTRUCTIONS

REMOVING GUIDE BAR AND CHAIN



NOTE: Always wear heavy gloves when handling the saw chain.

1. Make sure the Chain Brake® lever is pulled back into the DISENGAGED position (Fig. 21). Remove bar retaining nuts with supplied multi-purpose tool (Fig. 22).
2. Remove chain brake cover (C, Fig. 22) and outer guide bar plate (I, Fig. 27) by pulling straight out (Fig. 22).
3. Slide bar off the two bar bolts and remove chain (Fig. 23).

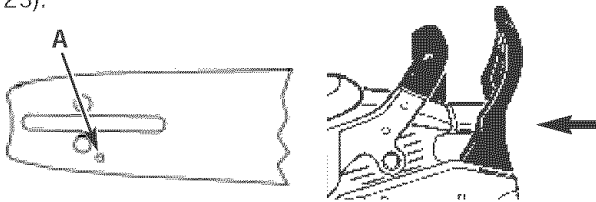

Fig. 21

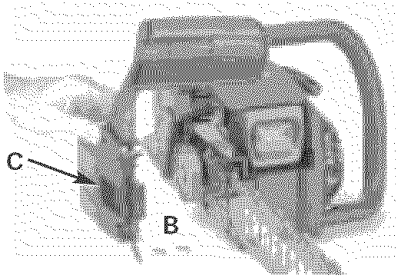

Fig. 22

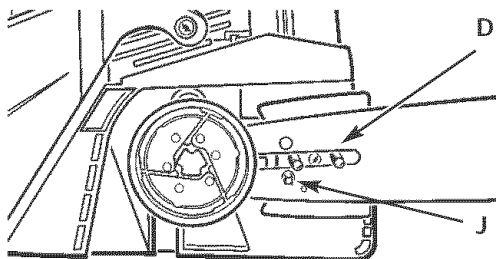

Fig. 23

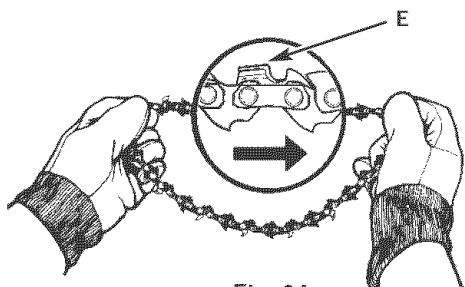

Fig. 24

REPLACING GUIDE BAR AND CHAIN



1. Spread chain out in a loop with cutting edges (E) pointing CLOCKWISE around loop (Fig. 24).
2. Slip the chain around the sprocket (F) behind the clutch (G). Make sure the links fit between the sprocket teeth (Fig. 25).
3. Place the slotted end of the guide bar over the two bar bolts (D, Fig. 23). Be sure adjusting tang (J, Fig. 23) is in lower adjusting hole of the bar.
4. Guide the drive links into the groove (H) and around the end of the bar (Fig. 25).
5. The chain will be tight so you will have to rotate the clutch clockwise by hand so the chain engages the bar sprocket.
6. Replace the outer guide bar plate (I) so the bent edges (top and bottom) are directed away from the chain (Fig. 27).
7. Install the Chain Brake® cover (Fig. 27). Make sure the chain does not slip off of the bar. Install the 2 bar retaining nuts hand tight and follow instructions in Saw Chain Tension Adjustment.

NOTE: The guide bar retaining nuts are installed only hand tight at this point because saw chain adjustment is required. Follow instructions in Saw Chain Tension Adjustment.

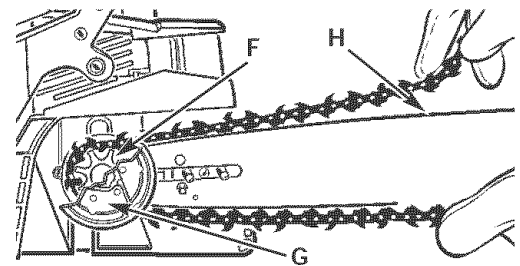

Fig. 25

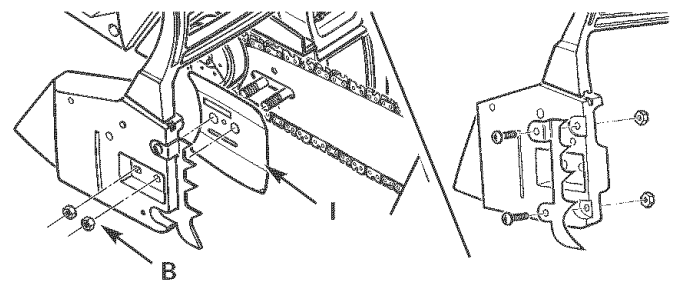

Fig. 27

MAINTENANCE AND REPAIR INSTRUCTIONS

SAW CHAIN TENSION ADJUSTMENT



Proper tension of saw chain is extremely important and must be checked before starting, as well as during any cutting operation.

Taking the time to make needed adjustments to the saw chain will result in improved cutting performance and prolonged chain life.

To adjust the saw chain:

1. Loosen the bar retaining nut(s) (B, Fig. 27). Hold nose of guide bar up and turn adjustment screw (D) CLOCKWISE to increase chain tension. Turning screw COUNTERCLOCKWISE will decrease amount of tension on chain. Ensure the chain fits snugly all the way around the guide bar (Fig. 28).

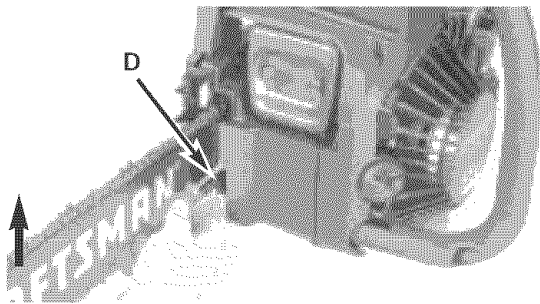

Fig. 28

2. After making adjustment, and while still holding nose of bar in the uppermost position, tighten the bar retaining nuts securely. Chain has proper tension when it has a snug fit all around and can be pulled around by gloved hand.

NOTE: If chain is difficult to rotate on guide bar or if it binds, too much tension has been applied. This requires minor adjustment as follows:

- A. Loosen the bar retaining nuts so they are hand tight. Decrease tension by turning the bar adjustment screw COUNTERCLOCKWISE slowly. Move chain back and forth on bar. Continue to adjust until chain rotates freely, but fits snugly. Increase tension by turning bar adjustment screw CLOCKWISE.
- B. When saw chain has proper tension, hold nose of bar in uppermost position and tighten the bar retaining nuts securely.

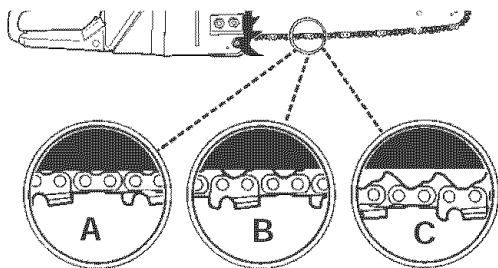
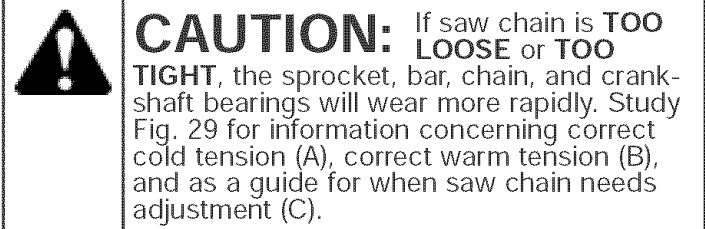
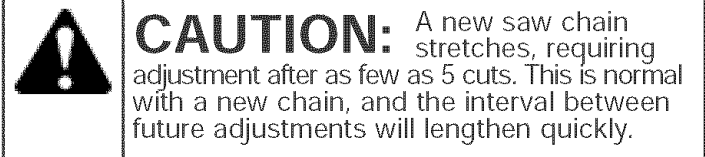
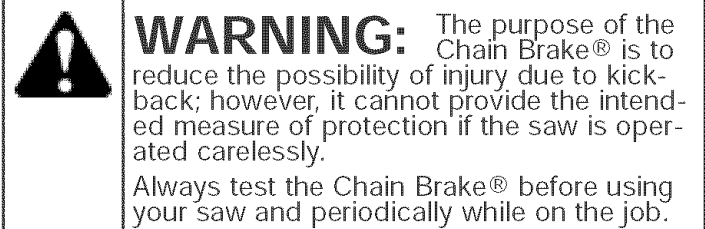

Fig. 29



CHAIN BRAKE MECHANICAL TEST



Your chain saw is equipped with a Chain Brake® that reduces possibility of injury due to kickback. The brake is activated if pressure is applied against brake lever when, as in the event of kickback, operator's hand strikes the lever. When the brake is activated, chain movement stops abruptly.

To Test the Chain Brake®:

1. The Chain Brake® is **DISENGAGED** (chain can move) when **BRAKE LEVER IS PULLED BACK AND LOCKED** (A, Fig. 30).
2. The Chain Brake® is **ENGAGED** (chain is stopped) when brake lever is in forward position. You should not be able to move chain (B, Fig. 30).

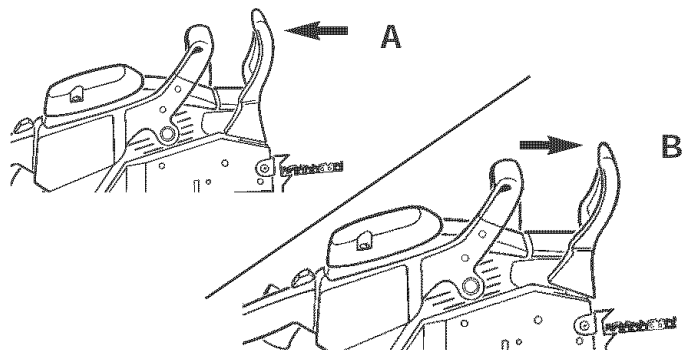

Fig. 30

MAINTENANCE AND REPAIR INSTRUCTIONS

MAINTENANCE REQUIREMENTS

CHECK FOR DAMAGED OR WORN PARTS

Check a Sears Service Center for replacement of damaged or worn parts.

NOTE: It is normal for a small amount of oil to appear under the saw after the engine stops. Do not confuse this with a leaking oil tank.

- STOP Switch - Ensure STOP switch functions properly by moving the switch up to the STOP position. Make sure the engine stops; then restart engine and continue.
- Fuel Tank - Do not use saw if fuel tank shows signs of damage or leaks.
- Oil Tank - Do not use saw if oil tank shows signs of damage or leaks.

CHECK FOR LOOSE FASTENERS AND PARTS

- Chain Brake Nuts
- Chain
- Muffler
- Cylinder Shield
- Air Filter cover
- Handle Screws
- Vibration Mounts
- Starter Housing
- Front Hand Guard

AIR FILTER



CAUTION: Never operate saw without the air filter. Dust and dirt will be drawn into engine and damage it. Keep the air filter clean.

1. Remove the top cover (A) by loosening the cover retaining screws. Cover will lift off (Fig. 31).
2. Clean air filter. Wash filter in clean, warm, soapy water. Rinse in clear, cool water. Air dry completely.

NOTE: It is advisable to have a supply of spare filters.

3. Install air filter. Install engine / air filter cover. Make sure cover fits properly. Tighten the cover retaining screws securely.



WARNING: To avoid serious personal injury, always turn your unit off and allow it to cool before you clean or service it.

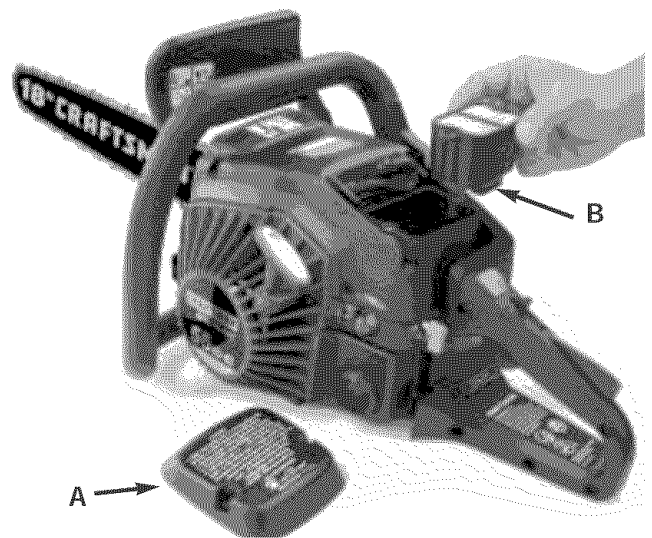

Fig. 31

FUEL FILTER



CAUTION: Never operate saw without the fuel filter. The fuel filter should be replaced after each 10 hours of use. Drain fuel tank before changing.

To empty fuel tank before removing fuel filter.

1. Pull fuel filter (A) out of tank with a bent wire (B) or long needle nosed pliers. Disconnect filter and discard (Fig. 32).

NOTE: Do not pull hose completely out of tank.

2. Install a new fuel filter on hose and push hose and filter assembly back into tank so filter is positioned in front right corner.
3. Fill tank with fresh fuel/oil mixture. See *Oil and Fuel Information*. Install fuel cap.

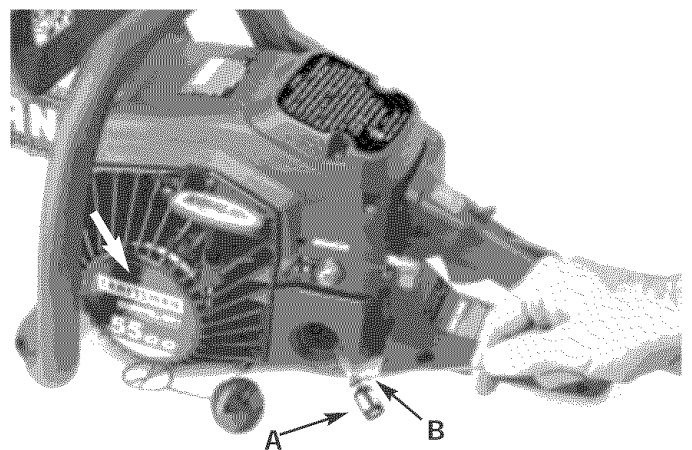

Fig. 32

MAINTENANCE AND REPAIR INSTRUCTIONS

OIL FILTER

NOTE: Drain oil reservoir before changing filter

1. Take the bottom plate off then use a wire with a hook (A) and pull oil filter (B) from reservoir. Remove old filter and replace.
2. Put filter and oil line back into oil reservoir so filter is at bottom of reservoir.

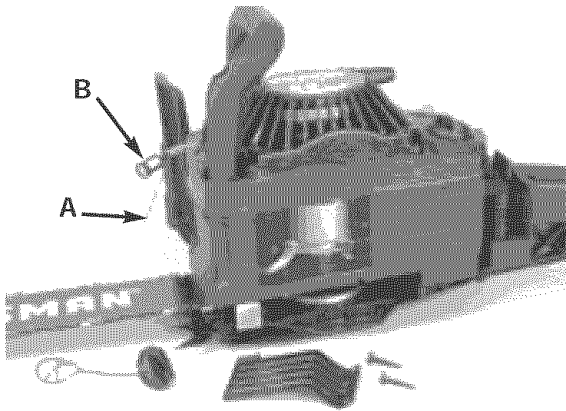

Fig. 33

SPARK ARRESTER SCREEN

NOTE: A clogged spark arrester screen will dramatically reduce engine performance.

1. To flatten the corners of the lock plate to be able to access the retaining nuts. Remove 2 muffler retaining nuts (E), Lock plate (F) and muffler cover (G) (Fig. 34).
2. Remove spark arrester screen (H) from the metal baffle (J). Replace screen with new one.
3. Reassemble the muffler components and tighten nuts securely.

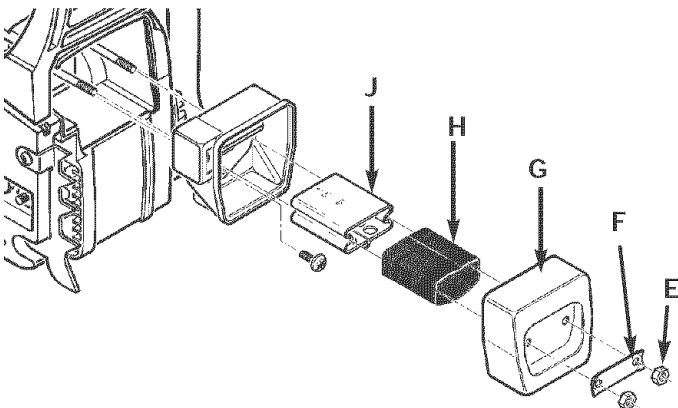

Fig. 34

SPARK PLUG

NOTE: For efficient operation of saw engine, spark plug must be kept clean and properly gapped.

1. Push STOP switch up.
2. Remove top Cover. Disconnect the wire connector from the spark plug by pulling and twisting at the same time (Fig. 35).
3. Remove spark plug with spark plug socket wrench. **DO NOT USE ANY OTHER TOOL.**



WARNING: Do not sand blast, scrape or clean electrodes. Grit in the engine could damage the cylinder.

4. Check electrode gaps with wire feeler gauge and set gaps to .025" (.635mm) if necessary.
5. Reinstall a new spark plug (champion RDJ8J or equivalent).

NOTE: A resistor spark plug must be used for replacement (part no. 9295-320001).

NOTE: This spark ignition system meets all requirements of the Canadian Interferen-Causing Equipment Regulations.

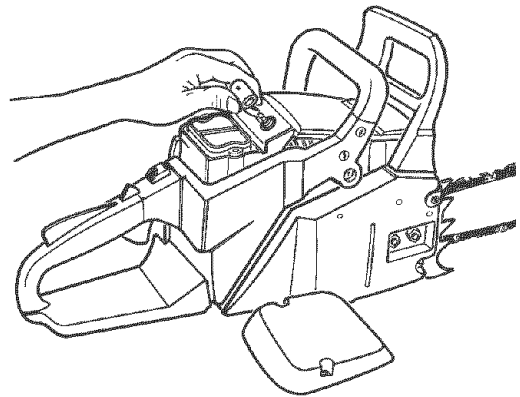

Fig. 35

CARBURETOR ADJUSTMENT

The carburetor was pre-set at the factory for optimum performance. If further adjustments are necessary, please take your unit to a Sears or other qualified service dealer.

MAINTENANCE AND REPAIR INSTRUCTIONS

STORING A CHAIN SAW



CAUTION: Never store a chain saw for longer than 30 days without performing the following procedures.

Storing a chain saw for longer than 30 days requires storage maintenance. Unless the storage instructions are followed, fuel remaining in the carburetor will evaporate, leaving gum-like deposits. This could lead to difficult starting and result in costly repairs.

1. Remove the fuel tank cap slowly to release any pressure in tank. Carefully drain the fuel tank by running the unit dry or by tipping the motor housing/fuel tank over and draining oil/fuel mixture into a container with the same 2-cycle fuel mixture.
2. Start the engine and let it run until the unit stops to remove fuel from carburetor.
3. Allow the engine to cool (approx. 5 minutes).
4. Using a spark plug wrench, remove the spark plug.
5. Pour 1 teaspoon of clean 2-cycle oil into the combustion chamber. Pull starter rope slowly several times to coat internal components. Replace spark plug (Fig. 36).

NOTE: Store the unit in a dry place and away from possible sources of ignition such as a furnace, gas hot water heater, gas dryer, etc.

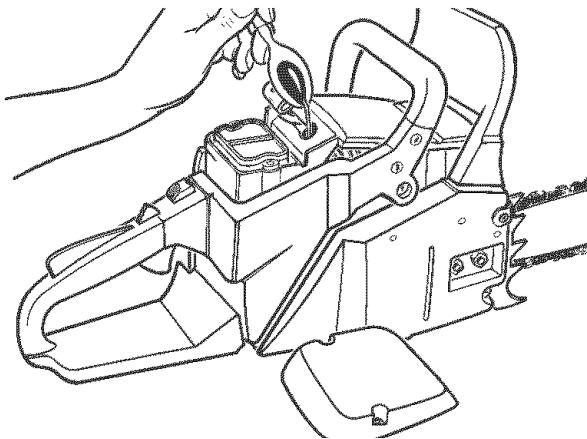

Fig. 36

REMOVING A UNIT FROM STORAGE

1. Remove spark plug.
2. Pull starter rope briskly to clear excess oil from combustion chamber.
3. Clean and gap spark plug or install a new spark plug with proper gap.
4. Prepare unit for operation.
5. Fill fuel tank with proper fuel / oil mixture. See Oil and Fuel Information.

GUIDE BAR MAINTENANCE

Frequent lubrication of the guide bar (railed bar which supports and carries the saw chain) sprocket tip is required. Proper maintenance of the guide bar, as explained in this section, is essential to keep your saw in good working condition.

Sprocket Tip Lubrication



CAUTION: The sprocket tip on your new saw has been pre-lubricated at the factory. Failure to lubricate the guide bar sprocket tip as explained below will result in poor performance and seizure, voiding the manufacturer's warranty.

Lubrication of the sprocket tip is recommended after 10 hours of use or once a week, whichever occurs first. Always thoroughly clean guide bar sprocket tip before lubrication.

The Lube Gun (not included) is recommended for applying grease to the guide bar sprocket tip. The Lube Gun is equipped with a needle nose tip which is necessary for the efficient application of grease to the sprocket tip.

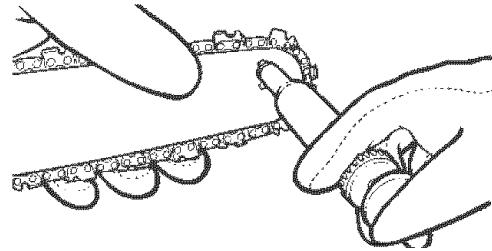

Fig. 37

To lubricate the sprocket tip:

1. Move the STOP switch up.

NOTE: It is not necessary to remove the saw chain to lubricate the guide bar sprocket tip. Lubrication can be done on the job.

2. Clean the guide bar sprocket tip.
3. Using the Lube Gun (not included), insert tip of lube gun into the lubrication hole and inject grease until it appears at outside edge of sprocket tip (Fig. 37).
4. Rotate saw chain by hand. Repeat lubrication procedure until the entire sprocket tip has been greased.

SAW CHAIN / BAR LUBRICATION

Adequate lubrication of the saw chain is essential at all times to minimize friction with the guide bar.

Never starve the bar and chain of oil. Running the saw with too little oil will decrease cutting efficiency, shorten saw chain life, cause rapid dulling of chain, and cause excessive wear of bar from overheating. Too little oil is evidenced by smoke, bar discoloration or pitch build-up.

NOTE: Saw chain stretches during use, particularly when it is new, and it will occasionally be necessary to adjust and tighten it. New chain will require adjustment after about 5 minutes of operation.

AUTOMATIC OILER

Refer to Section Other Instructions: Automatic Oiler for information on the automatic oiler.

MAINTENANCE AND REPAIR INSTRUCTIONS

GUIDE BAR MAINTENANCE:

Most guide bar problems can be prevented merely by keeping the chain saw well maintained.

Insufficient guide bar lubrication and operating the saw with chain that is too tight will contribute to rapid bar wear.

To help minimize bar wear, the following guide bar maintenance procedures are recommended.

BAR WEAR - Turn guide bar frequently at regular intervals (for example, after 5 hours of use), to ensure even wear on top and bottom of bar.

BAR GROOVES (B) Bar grooves (or rails which support and carry the chain) should be cleaned if saw has been used heavily or if saw chain appears dirty. Rails should always be cleaned every time saw chain is removed. (fig. 38)

OIL PASSAGES (A) Oil passages on the bar should be cleaned to ensure proper lubrication of the bar and chain during operation. This can be done using a soft wire small enough to insert into the oil discharge hole. (fig. 38)

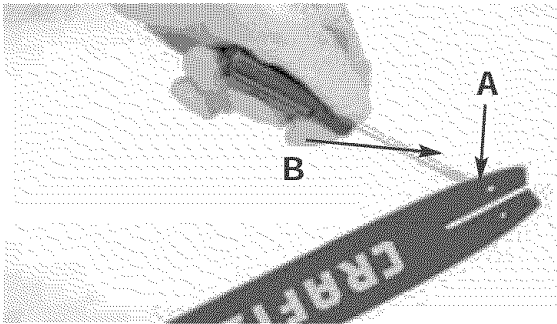

Fig. 38

NOTE: The condition of the oil passages can be easily checked. If the passages are clear, the chain will automatically give off a spray of oil within seconds of starting the saw. Your saw is equipped with an automatic oiler system.

CHAIN MAINTENANCE

Chain Tension

Check the chain tension frequently and adjust as often as necessary to keep the chain snug on the bar, but loose enough to be pulled around by hand.

Breaking in a New Saw Chain

A new chain and bar will need chain readjustment after as few as 5 cuts. This is normal during the break-in period, and the interval between future adjustments will begin to lengthen quickly.

Chain Lubrication

Always make sure the automatic oiler system is working properly. Keep the oil reservoir filled with Chain, Bar and Sprocket Oil.

Adequate lubrication of the bar and chain during cutting operations is essential to minimize friction with the guide bar.

Never starve the bar and chain of lubricating oil. Running the saw dry or with too little oil will decrease cutting efficiency, shorten saw chain life, cause rapid dulling of chain, and lead to excessive wear of bar from overheating. Too little oil is evidenced by smoke or bar discoloration.

Chain Sharpening

Chain sharpening requires special tools to ensure that cutters are sharpened at the correct angle and depth. For the inexperienced chain saw user, we recommend that the saw chain be professionally sharpened by the nearest Authorized Service Center. If you feel comfortable sharpening your own saw chain, special tools are available from your Authorized Service Center.

CHAIN REPLACEMENT INFORMATION

Bar Length	Drive Links	Sears Part #
18" Bar	72 DL	36514

INERTIA CHAIN BRAKE® ACTION

NOTE: THIS SAW IS EQUIPPED WITH AN INERTIA CHAIN BRAKE. IF THE SAW KICKS BACK WHILE IN USE, THE INERTIA OF THE MOVING SAW WILL ACTIVATE THE BRAKE. A BRAKE BAND AROUND THE CLUTCH DRUM ACTIVATES AND STOPS THE MOVING CHAIN.



WARNING: Never have more than 3 links removed from a loop of chain. This could cause damage to the sprocket.

TROUBLESHOOTING

UNIT WON'T START OR STARTS BUT WILL NOT RUN

CAUSE

1. Incorrect starting procedures
2. Incorrect carburetor mixture adjustment setting
3. Fouled spark plug
4. Empty fuel tank
5. Primer bulb was not pressed enough

ACTION

1. Follow instructions in the Starting/Stopping section
2. Have carburetor adjusted by a Sears or other qualified service dealer
3. Clean/gap or replace plug
4. Fill fuel tank with properly mixed fuel
5. Press primer bulb fully and slowly 10 times

UNIT STARTS, BUT ENGINE HAS LOW POWER

CAUSE

1. Fuel filter is plugged
2. Incorrect lever position
3. Dirty spark arrestor screen
4. Dirty air filter
5. Incorrect carburetor mixture adjustment setting

ACTION

1. Replace the fuel filter
2. Move to Position 3
3. Replace spark arrestor screen
4. Remove, clean and reinstall filter
5. Have carburetor adjusted by a Sears or other qualified service dealer

ENGINE HESITATES

CAUSE

1. Incorrect carburetor mixture adjustment setting
2. Air filter is plugged
3. Old or improperly mixed fuel

ACTION

1. Have carburetor adjusted by a Sears or other qualified service dealer
2. Replace or clean the air filter
3. Drain gas tank/add fresh fuel mixture

NO POWER UNDER LOAD

CAUSE

1. Incorrect carburetor mixture adjustment setting
2. Old or improperly mixed fuel
3. Air filter is plugged
4. Fouled spark plug

ACTION

1. Have carburetor adjusted by a Sears or other qualified service dealer
2. Drain gas tank (see Storage)/add fresh fuel mixture
3. Replace or clean the air filter
4. Replace or clean the spark plug

RUNS ERRATICALLY

CAUSE

1. Incorrectly gapped spark plug
2. Plugged spark arrestor
3. Dirty air filter

ACTION

1. Clean/gap or replace plug
2. Clean or replace spark arrestor
3. Clean or replace air filter

SMOKES EXCESSIVELY

CAUSE

1. Incorrect carburetor mixture adjustment setting
2. Incorrect fuel mixture

ACTION

1. Have carburetor adjusted by a Sears or other qualified service dealer
2. Use properly mixed fuel (40:1 mixture)

NOTE: For repairs beyond the minor adjustments listed above, contact your nearest Sears Parts & Repair center at (1-800-4-MY-HOME®) or other qualified service dealer for an adjustment.

SPECIFICATIONS

ENGINE*

Engine Type	Air-Cooled, 2-Cycle
Displacement.....	(55 cc)(3.36 cu in.)
Idle Speed RPM	3,400 rpm
Operating RPM.....	7,200+ rpm
Ignition Type	Electronic-MAX FIRE IGNITION™
Ignition Switch	Slide Switch
Spark Plug Gap	0.025 in. (0.635 mm)
Lubrication	Fuel/Oil Mixture
Fuel/Oil Ratio.....	40:1
Carburetor	Diaphragm, All-Position
Starter	Incredi-Pull™ Starting Auto Rewind
Muffler	Baffled with Guard
Throttle.....	Manual Spring Return
Fuel Tank Capacity.....	16.8 oz. (496.8 ml)
Throttle Control.....	Finger-Tip Trigger
Approximate Unit Weight (No fuel)	17.6 lbs. (8 kg)
Cutting Diameter	36 in. (91.4 cm)

*All specifications are based on the latest product information available at the time of printing. We reserve the right to make changes at any time without notice.

SPECIFICATIONS

ENGINE*

Engine Type	Air-Cooled, 2-Cycle
Displacement.....	(55 cc)(3.36 cu in.)
Idle Speed RPM	3,400 rpm
Operating RPM.....	7,200+ rpm
Ignition Type	Electronic-MAX FIRE IGNITION™
Ignition Switch	Slide Switch
Spark Plug Gap	0.025 in. (0.635 mm)
Lubrication	Fuel/Oil Mixture
Fuel/Oil Ratio.....	40:1
Carburetor	Diaphragm, All-Position
Starter	Incredi-Pull™ Starting Auto Rewind
Muffler	Baffled with Guard
Throttle.....	Manual Spring Return
Fuel Tank Capacity.....	16.8 oz. (496.8 ml)
Throttle Control.....	Finger-Tip Trigger
Approximate Unit Weight (No fuel)	17.6 lbs. (8 kg)
Cutting Diameter	36 in. (91.4 cm)

*All specifications are based on the latest product information available at the time of printing. We reserve the right to make changes at any time without notice.

PARTS LIST

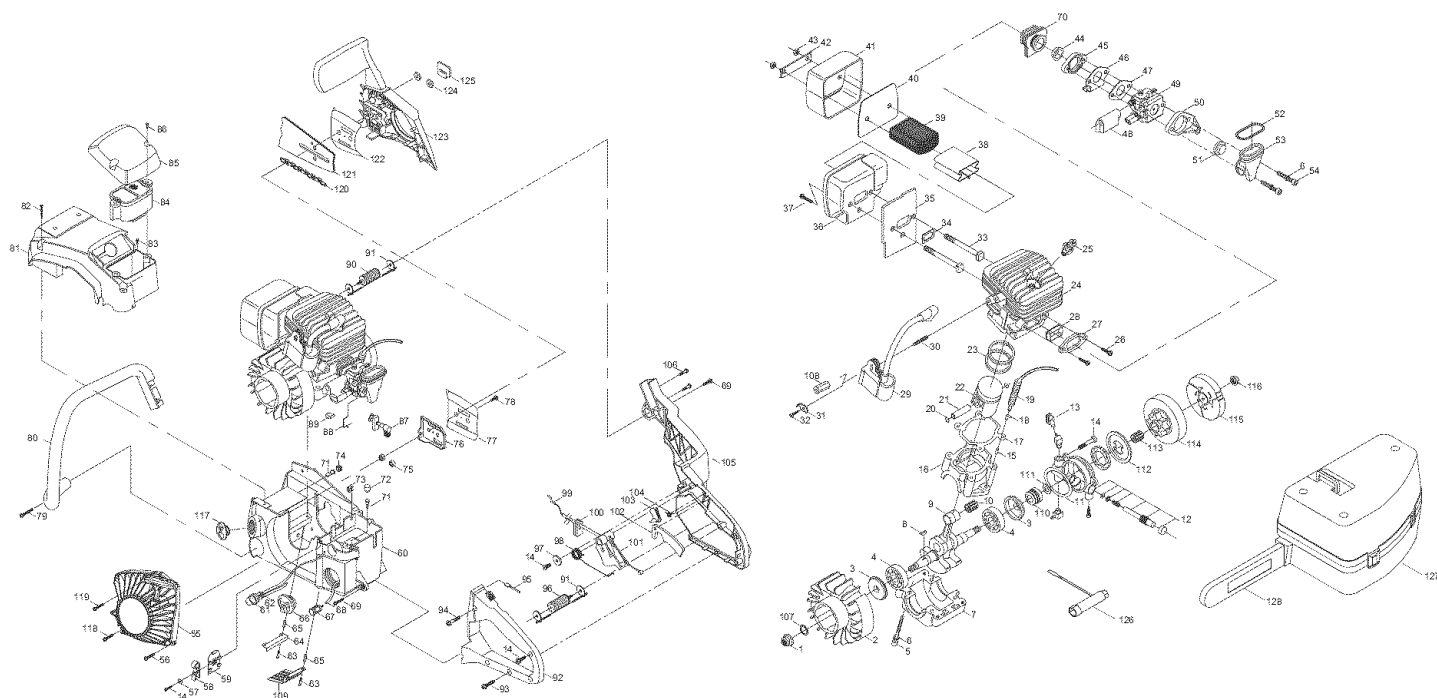

Item	Parts No.	Description	Item	Parts No.	Description	Item	Parts No.	Description	Item	Parts No.	Description
1	9NAB-5/16-24	NUT	34	9014-310208	WASHER	67	9182-310001	FILTER, FUEL	100	9124-310209	GROMMET
2	9228-31B206	FLYWHEEL	35	9082-310201	BAFFLER	68	9129-310004	HOSE	101	9028-310202	TRIGGER
3	9157-310201	SEAL	36	9228-310217	MUFFLER BODY ASSY	69	9SKKZY10/14-01	SCREW	102	9028-310201	RELEASE, TRIGGER
4	9DB-620201	BEARING	37	9SKKBY10/24-0.5	SCREW	70	9124-310202	BOOT, CARB	103	9072-310203	LATCH, HIGH IDLE
5	9SREB-10/24-2.75	SCREW	38	9211-310201	PLATE	71	9070-310002	VALVE DUCKBILL	104	9024-310207	SPRING
6	9WFB-0.2	WASHER	39	9183-310201	SCREEN	72	9129-310209	HOSE	105	9068-310203	FRAME, REAR
7	9072-310201F	CRANKCASE LOWER	40	9082-310205	BAFFLER	73	9013-310201	PLUG	106	9SGKY10/24-0.5	SCREW
8	9221-310001	KEY	41	9017-310204	COVER, MUFFLER	74	9252-310002	FILTER	107	9WOC-08	WASHER
9	9228-310203F	C'SHAFT/CRD ASS'Y	42	9158-310201	LOCKPLATE	75	9131-310206	WASHER	108	9124-310205	SPACER
10	9155-310201	BEARING	43	9NAC-10/24	NUT	76	9043-310203	PLATE, BAR	109	9043-310205	PLATE
11	9076-310201	O RING	44	9131-310203	EYELET	77	9043-310202	PLATE, FLANGE	110	9012-330301	GROMMET
12	9228-310208	PUMP ASS'Y	45	9014-310204	FLANGE	78	9SKKYB/19-0.375	SCREW	111	6014-M96A01	WASHER
13	9154-310201	CONNECTOR	46	9102-310202	PLATE	79	9SJKB-12/14-1.5	SCREW	112	6182-210101	FILTER
14	9SKKBY8/16-0.5	SCREW	47	9014-310202	GASKET	80	9228-31B202	HANDLE ASS'Y	113	9073-310201	GEAR, WORM
15	9124-310201	FITTING, PULSE LINE	48	9124-310203	BOOT	81	9228-310216	COVER ASS'Y	114	9WFN-0.4	WASHER
16	9072-310202F	CRANKCASE UPPER	49	9287-310201	CARB	82	9SKKBY10/14-02	SCREW	115	9WDZ-0.722	WASHER
17	9014-310212	GASKET	50	9014-310201	FLANGE	83	9SKKBY10/14-0.68	SCREW	116	9155-310203	BEARING
18	9036-310201	CLAMP, WIRE HOSE	51	9131-310204	EYELET	84	9228-310204	AIR CLEANER ASS'Y	117	9228-310211	DRUM SPRKT ASS'Y
19	9059-310201	CONDUIT, FLEX	52	9024-310202	SPRING	85	9067-310202	COVER	118	9228-310210	CLUTCH ASS'Y
20	9CA-0.46	RING	53	9124-310204	BOOT	86	9214-310101	SCREW	119	9NHC-09	NUT
21	9PC-10-32.5	PIN	54	9SREB-10/24-1.625	SCREW	87	9228-310230	CHOKE ASS'Y	120	9228-310207	CAP, OIL
22	9290-310201	PISTON	55	9228-31B208	STARTER ASS'Y	88	9114-310202	ROD, CHOKE	121	9SKKBY10/14-	SCREW
23	9189-310201	RING, PISTON	56	9SKKBY10/14-0.625	SCREW	89	9013-310202	PLUG	122	0.625	SCREW
24	9292-310201F	CYLINDER	57	9WFZ-0.18	WASHER	90	9228-310213	ISOLATOR ASS'Y	123	9SKKBY10/24-0.5	CHAIN
25	9295-320001	SPARK PLUG	58	9223-310201		91	9228-310214	CABLE ASS'Y	124	9220-310202	BAR (CRAFTSMAN LOGO)
26	9SKKBY10/24-0.62	SCREW	59	9183-310202	SCREEN	92	9228-310232	COVER ASS'Y, HANDLE	125	9040-310225	PLATE
27	9014-310203	FLANGE	60	9228-310205	FUEL/OIL TANK ASS'Y	93	9SKKYB/16-0.625	SCREW	126	9082-310204	CHAIN BRAKE ASS'Y
28	9131-310202	EYELET	61	9142-310002	PRIMER, REMOTE	94	9SKKBY-8/16-1	SCREW	127	9228-310245	NUT
29	9288-310201-CH	IGNITION ASS'Y	62	9129-310214	HOSE	95	9010-310203	WIRE	128	9NAZ-5/16-18	PLATE
30	9191-310201	STUD	63	9SKKBY10/24-1	SCREW	96	9228-310222	ISOLATOR ASS'Y	129	9072-310206	WRENCH
31	9051-310202	CONTACT, CROUT	64	9043-310201	PLATE	97	9WFB-4.9-17	WASHER	130	9042-310201	CARRY CASE
32	9SKKBY10/24-0.75	SCREW	65	9124-310206	SPACE	98	9024-310206	SPRING	131	9120-MD0701	SCABBARD
33	9STDZY10/24-2.79	SCREW	66	9228-310206	CAP, FUEL	99	9010-310201	CABLE		9017-310214	

California / EPA Emission Control Warranty Statement

Your Warranty Rights and Obligations

The California Air Resources Board, The Environmental Protection Agency and Sears, Roebuck and Co., are pleased to explain the emission control system warranty on your 2005 and later small off-road engine. In California and the 49 states, new small off-road engines must be designed, built and equipped to meet stringent anti-smog standards. Sears must warrant the emission control system on your small off-road engine for the periods of time listed below provided there has been no abuse, neglect or improper maintenance of your small off-road engine.

Your Emission control system may include parts such as the carburetor or fuel-injection system, the ignition system, and catalytic converter. Also included may be hoses, belts, connectors and other emission-related assemblies.

Where a warrantable condition exists, Sears will repair your small off-road engine at no cost to you including diagnosis, parts and labor.

The 2005 and later small off-road engines are warranted for two years. If any emission-related part on your engine is defective, the part will be repaired or replaced by Sears.

Owner's Warranty Responsibilities

- As the small off-road engine owner, you are responsible for the performance of the required maintenance listed in your operator's manual. Sears recommends that you retain all receipts covering maintenance on your small off-road engine, but Sears cannot deny warranty solely for the lack of receipts or for your failure to ensure the performance of all scheduled maintenance.
- As the small off-road engine owner, you should however be aware that Sears may deny you warranty coverage if your small off-road engine or a part has failed due to abuse, neglect, improper maintenance or unapproved modifications.
- You are responsible for presenting your small off-road engine to a Sears authorized service center as soon as problem exists. The warranty repairs should be completed in a reasonable amount of time, not to exceed 30 days.

If you have any questions regarding your warranty rights and responsibilities, you should call 1-800-4-MY-HOME®.

Manufacturer's Warranty Coverage

- The warranty period begins on the date the engine or equipment is delivered to the retail purchaser.
- The manufacturer warrants to the initial owner and each subsequent purchaser, that the engine is free from defects in material and workmanship which cause the failure of a warranted part for a period of one year.
- Repair and replacement of warranted part will be performed at no charge to the owner at an authorized Sears service center. For the nearest location please contact Sears at: 1-800-4-MY-HOME®.
- Any warranted part which is not scheduled for replacement, as required maintenance or which is scheduled only for regular inspection to the effect of "Repair or Replace as Necessary" is warranted for the period. Any warranted part which is scheduled for replacement as required maintenance will be warranted for the period of time up to the first scheduled replacement point for that part.
- The owner will not be charged for diagnostic labor which leads to the determination that a warranted part is defective if the diagnostic work is performed at an authorized Sears Service Center.
- The manufacturer is liable for damages to other engine components caused by the failure of a warranted part still under warranty.
- Failures caused by abuse, neglect or improper maintenance are not covered under warranty.
- The use of add-on or modified parts can be grounds for disallowing a warranty claim. The manufacturer is not liable to cover failures of warranted parts caused by the use of add-on or modified parts.
- In order to file a claim, go to your nearest authorized Sears Service Center. Warranty service or repairs will be provided at all authorized Sears Service Centers.
- Any manufacturer approved replacement part may be used in the performance of any warranty maintenance or repair of emission related parts and will be provided without charge to the owner. Any replacement part that is equivalent in performance or durability may be used in non-warranty maintenance or repair and will not reduce the warranty obligations of the manufacturer.
- The following components are included in the emission related warranty: engine, air filter, carburetor, primer, fuel lines, fuel pick up/fuel filter, ignition module, spark plug and muffler.

Repair Protection Agreements

Congratulations on making a smart purchase. Your new Craftsman® product is designed and manufactured for years of dependable operation. But like all products, it may require repair from time to time. That's when having a Repair Protection Agreement can save you money and aggravation.

Purchase a Repair Protection Agreement now and protect yourself from unexpected hassles and expense.

Here's what's included in the Agreement:

- Expert service** by our 12,000 professional repair specialists
- Unlimited service and no charge** for parts and labor on all covered repairs
- Product replacement** if your covered product can't be fixed
- Discount of 10%** from regular price of service and service-related parts not covered by the agreement; also, 10% off regular price of preventive maintenance check
- Fast help by phone** - phone support from a Sears technician on products requiring in-home repair, plus convenient repair scheduling

Once you purchase the Agreement, a simple phone call is all that it takes for you to schedule service. You can call anytime day or night, or schedule a service appointment online.

Sears has over 12,000 professional repair specialists, who have access to over 4.5 million quality parts and accessories. That's the kind of professionalism you can count on to help prolong the life of your new purchase for years to come. Purchase your Repair Protection Agreement today!

Some limitations and exclusions apply. For prices and additional information call 1-800-627-6888.

Sears Installation Service

*For Sears professional installation of home appliances, garage door openers, water heaters, and other major home items, in the U.S.A. call 1-800-4-MY-HOME**

Get it fixed, at your home or ours!

Your Home

For repair - in your home - of all major brand appliances,
lawn and garden equipment, or heating and cooling systems,
no matter who made it, no matter who sold it!

For the replacement parts, accessories and
owner's manuals that you need to do-it-yourself.

For Sears professional installation of home appliances
and items like garage door openers and water heaters.

1-800-4-MY-HOME® (1-800-469-4663)

Call anytime, day or night (U.S.A. and Canada)

www.sears.com www.sears.ca

Our Home

For repair of carry-in items like vacuums, lawn equipment,
and electronics, call or go on-line for the location of your nearest
Sears Parts & Repair Center.

1-800-488-1222

Call anytime, day or night (U.S.A. only)

www.sears.com

To purchase a protection agreement (U.S.A.)
or maintenance agreement (Canada) on a product serviced by Sears:

1-800-827-6655 (U.S.A.)

1-800-361-6665 (Canada)

Para pedir servicio de reparación
a domicilio, y para ordenar piezas:

1-888-SU-HOGAR™

(1-888-784-6427)

Au Canada pour service en français:

1-800-LE-FOYER™

(1-800-533-6937)

www.sears.ca

Sears

® Registered Trademark / ™ Trademark / ™ Service Mark of Sears, Roebuck and Co.

® Marca Registrada / ™ Marca de Fábrica / ™ Marca de Servicio de Sears, Roebuck and Co.

® Marque de commerce / ™ Marque déposée de Sears, Roebuck and Co.

© Sears, Roebuck and Co.