



ENDURANCE / CHALLENGER MODULAR SERIES GAS RANGES



VULCAN 12
24S
36S, 36C
48C, 48S, 48SS
60SS, 60SC, 60CS
72SS, 72SC, 72CC, 72CS

WOLF C12,
C24S
C36S, C36C
C48S, C48SS, C48C
C60SS, C60SC, C60CS
C72SS, C72SC, C72CC, C72CS

This Manual is prepared for the use of trained Vulcan Service Technicians and should not be used by those not properly qualified.

This manual is not intended to be all encompassing. If you have not attended a Vulcan Service School for this product, you should read, in its entirety, the repair procedure you wish to perform to determine if you have the necessary tools, instruments and skills required to perform the procedure. Procedures for which you do not have the necessary tools, instruments and skills should be performed by a trained Vulcan Service Technician.

The reproduction, transfer, sale or other use of this Manual, without the express written consent of Vulcan, is prohibited.

This manual has been provided to you by ITW Food Equipment Group LLC ("ITW FEG") without charge and remains the property of ITW FEG, and by accepting this manual you agree that you will return it to ITW FEG promptly upon its request for such return at any time in the future.

For additional information on Vulcan-Hart Company or to locate an authorized parts and service provider in your area, visit our website at www.vulcanequipment.com

TABLE OF CONTENTS

SERVICE UPDATES	4
SERVICE UPDATES	4
GENERAL	5
INTRODUCTION	5
INSTALLATION, OPERATION AND CLEANING	5
LUBRICATION	5
TOOLS	5
SPECIFICATIONS	5
REMOVAL AND REPLACEMENT OF PARTS	7
GRIDDLE MANIFOLD COVER (PREVIOUS PRODUCTION)	7
GRIDDLE MANIFOLD COVER (CURRENT PRODUCTION)	7
CONTROL BRACKET COVER	8
CONTROL PANEL (30" OVENS)	8
KICK PANEL (24" & 30" OVENS)	9
BULL NOSE	9
GRIDDLE CONTROL BRACKET (PREVIOUS PRODUCTION)	9
GRIDDLE CONTROL BRACKET (THERMOSTACTICALLY CONTROLLED - CURRENT PRODUCTION)	10
STANDARD OVEN PILOT ASSEMBLY AND THERMOCOUPLE	11
STANDARD OVEN BURNER	11
STANDARD OVEN THERMOSTAT (24" OVEN)	12
STANDARD OVEN THERMOSTAT (30" OVEN)	13
CONVECTION OVEN PILOT ASSEMBLY AND THERMOCOUPLE	14
CONVECTION OVEN BURNER	15
CONVECTION OVEN THERMOSTAT VALVE	16
CONVECTION OVEN BLOWER AND MOTOR	16
BURNER ORIFICE (STANDARD AND CONVECTION OVENS)	17
GAS SAFETY VALVE (STANDARD AND CONVECTION OVENS)	18
TOP BURNER PILOT VALVE	19
TOP BURNER ASSEMBLY	20
TOP BURNER CONTROL VALVE	20
TOP BURNER ORIFICE HOOD	21
OVEN DOOR	21
GAS PRESSURE REGULATOR	22
CONVECTION OVEN DOOR SWITCH	23
CONVECTION OVEN SOLENOID	23
GRIDDLE THERMOSTAT VALVE (PREVIOUS PRODUCTION)	24
GRIDDLE THERMOSTAT VALVE (CURRENT PRODUCTION)	26
GRIDDLE GAS SAFETY VALVE (PREVIOUS PRODUCTION)	28
GRIDDLE SAFETY VALVE (CURRENT PRODUCTION)	28
GRIDDLE PILOT ASSEMBLY AND THERMOCOUPLE (PREVIOUS PRODUCTION)	30
GRIDDLE PILOT ASSEMBLY AND THERMOCOUPLE (CURRENT PRODUCTION)	30
GRIDDLE BURNER ORIFICE HOOD (PREVIOUS PRODUCTION)	31
GRIDDLE BURNER ORIFICE HOOD (CURRENT PRODUCTION)	31
CHARBROILER PILOT	32
CHARBROILER BURNER	33
SAFETY VALVE (FLAME SAFETY OPTION)	35
OVEN SAFETY VALVE (CURRENT PRODUCTION)	36
ROTARY IGNITER (FLAME SAFETY OPTION)	39
TOP BURNER PILOT ASSEMBLY AND THERMOCOUPLE (FLAME SAFETY OPTION)	39
DOOR STOP	41
SERVICE PROCEDURES AND ADJUSTMENTS	43
PILOT FLAME HEIGHT	43
OVEN PILOT ADJUSTMENT	43



TOP BURNERS PILOT ADJUSTMENT	43
BURNER AIR SHUTTER ADJUSTMENT	43
REGULATOR ADJUSTMENT	44
BURNER NOZZLE CHECK	45
STANDARD OVEN THERMOSTAT BY-PASS FLAME ADJUSTMENT	45
STANDARD OVEN THERMOSTAT TEMPERATURE CALIBRATION	46
CONVECTION OVEN THERMOSTAT VALVE CALIBRATION	47
OPERATION	47
CALIBRATION	47
GRIDDLE THERMOSTAT VALVE CALIBRATION	48
OPERATION	48
CALIBRATION	48
THERMOCOUPLE TEST	49
OPERATION	49
PILOT CHECKS	49
THERMOCOUPLE CHECKS	49
CHARBROILER PILOT ADJUSTMENT	50
ELECTRICAL OPERATION	51
COMPONENT FUNCTION	51
COMPONENT LOCATION	51
SEQUENCE OF OPERATION - CONVECTION OVEN	52
SCHEMATIC DIAGRAM - CONVECTION OVENS	53
WIRING DIAGRAM - CONVECTION OVENS	54
TROUBLESHOOTING	55
TROUBLESHOOTING	55



SERVICE UPDATES

SERVICE UPDATES

This section lists the service updates to the information in the manual.

January 2021

- Updated STANDARD OVEN THERMOSTAT TEMPERATURE CALIBRATION.

June 2019

- Added GRIDDLE MANIFOLD COVER (CURRENT PRODUCTION).
- Added GRIDDLE CONTROL BRACKET (THERMOSTACTICALLY CONTROLLED - CURRENT PRODUCTION).
- Added GRIDDLE THERMOSTAT VALVE (CURRENT PRODUCTION).
- Added GRIDDLE SAFETY VALVE (CURRENT PRODUCTION).
- Added GRIDDLE PILOT ASSEMBLY AND THERMOCOUPLE (CURRENT PRODUCTION).
- Added GRIDDLE BURNER ORIFICE HOOD (CURRENT PRODUCTION).
- Added OVEN SAFETY VALVE (CURRENT PRODUCTION).

July 2018

- Updated TOOLS and OVEN DOOR. Changed bolt used as tool must fit into hinge slot.

GENERAL

INTRODUCTION

This manual is for the **Endurance / Challenger XL™** Modular Series Gas Ranges. Procedures in this manual will apply to all models unless specified. Pictures and illustrations will be of model 60SC unless otherwise noted.

All of the information, illustrations and specifications contained in this manual are based on the latest product information available at the time of printing.

INSTALLATION, OPERATION AND CLEANING

Refer to F38201 VULCAN ENDURANCE / WOLF CHALLENGER Modular Series Gas Restaurant Ranges I/O Manual for detailed installation, operation and cleaning instructions.

LUBRICATION

Anderson and Forrester (or comparable) valve grease for top burner gas valves, top burner pilot valves, and pressure tap plugs. Apply light coat to valve/plug threads. Valve grease must be insoluble in propane and natural gas.

TOOLS

Standard

- Standard set of hand tools.
- VOM with minimum of NFPA-70E CATIII 600V, UL/CSA/TUV listed. Sensitivity of at least 20,000 ohms per volt and the ability to measure DC micro amps. Meter leads must also be rated at CAT III 600V.
- Pipe thread sealant suitable for use with propane gas.

Special

- Temperature tester (K type thermocouple preferred).
- Manometer.
- Long reach phillips screwdriver #2 for installing or removing motor assembly through the convection oven cavity.
- Two 1" long bolts that fit into door hinge slot. (size varies depending on revision of doors).

⚠ WARNING

The screws are used to relieve spring tension on the door hinge during door removal and installation.

- Loctite® 246™ for use on the door handle mounting screws.
- A non permanent type sealer (preferably fast drying) such as nail polish or equivalent for sealing thermostat adjustment screw. If using Loctite 242, it begins to set in approximately 10 minutes and fully cures in 24 hours according to manufacturer.
- 3/4" pipe tee and hose barb assembly for temporarily checking manifold pressure when a pressure tap is not available in the gas manifold on some models.
- Pipe taps may be needed to clean or repair internal threads on gas manifolds. Use a wire brush to clean external pipe threads on fittings.
- Adaptor to test thermocouple closed circuit DC voltages (purchase locally). Adaptors vary between manufacturers. An example of one adaptor type is pictured below.



Fig. 1

SPECIFICATIONS

Gas Pressures

- Manifold/Operating Pressure
 - Natural: 5 in. W.C.
 - Propane: 10 in. W.C.
- Inlet Supply Pressure
 - Natural - Recommended 7 in. W.C. ; Minimum 5 in. W.C.
 - Propane - Recommended 11 in. W.C. ; Minimum 11 in. W.C.
 - Maximum 14 in. W.C. (0.5 PSI) (Natural or Propane)

Orifice Size Requirements

- See Orifice Chart in Parts Catalog F43260
ENDURANCE/CHALLENGER MODULAR
SERIES GAS RANGES.



REMOVAL AND REPLACEMENT OF PARTS

GRIDDLE MANIFOLD COVER (PREVIOUS PRODUCTION)



⚠ WARNING

Shut off the gas before servicing the unit and follow lockout / tagout procedures.

NOTE: The information in this section applies only to production built up to 5/12/19 for Manual Griddles models starting at Serial Number 481949646. Production built up to 2/14/19 for T-stat Griddles models Serial Number 481938361.

1. Pull crumb tray out.
2. Loosen set screw in the top burner control knobs and remove knobs. If range includes the safety flame option, remove the rotary igniter knob.
3. Remove screws that secure manifold cover and remove cover.
4. Reverse procedure to install.



Fig. 3

GRIDDLE MANIFOLD COVER (CURRENT PRODUCTION)

NOTE: The information in this section applies only to current production starting on 5-13-19 for Manual Griddles models starting at Serial Number 481949647. Starting on 2-15-19 for T-stat Griddles models Serial Number 481938362.



⚠ WARNING

Disconnect the electrical power to the machine and follow lockout / tagout procedures.

1. Pull out crumb trays and grease trays if applicable.
2. Loosen set screws knobs.



Fig. 4

3. Pull off ignitor and disconnect wiring.

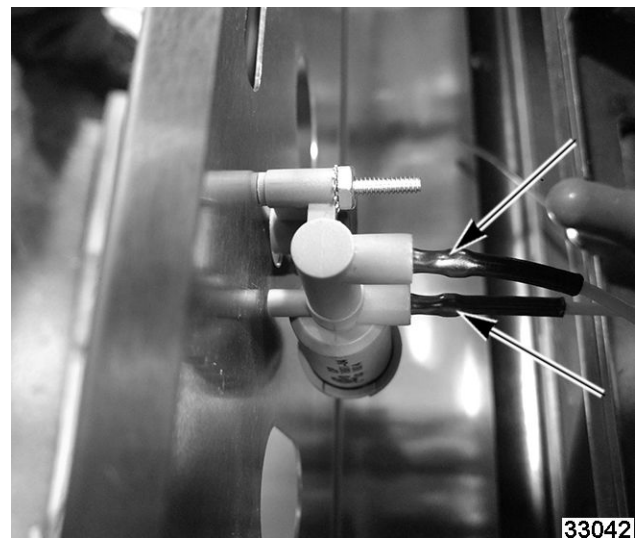

Fig. 5

4. Remove manifold mounting screws.



Fig. 6

- Reverse procedure to install.

CONTROL BRACKET COVER



WARNING

Shut off the gas before servicing the unit and follow lockout / tagout procedures.

- Pull grease can out.
- Pull knobs from thermostats.
- If removing control bracket cover from oven with a 12" open top burner module and 24" griddle top module:
 - Pull crumb tray out of 12" section if installed.
 - Loosen set screw in the open top burner control knobs and remove knobs.
- Remove screws that secure control bracket cover and remove the bracket.
- Reverse procedure to install.

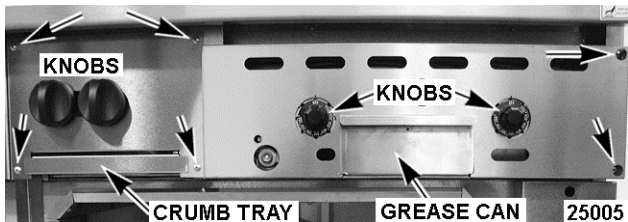

Fig. 7

CONTROL PANEL (30" OVENS)



WARNING

Disconnect the electrical power to the machine and follow lockout / tagout procedures.



WARNING

Shut off the gas before servicing the unit and follow lockout / tagout procedures.

NOTE: Electrical power disconnect warning applies to convection ovens.

NOTE: Removal procedure applies to standard and convection 30" ovens.

- Pull knob from thermostat.
- Remove hole plug at top of control panel.
- Remove screw and lift off control panel.
- On convection ovens only, note lead wire locations and disconnect from power switch.
- Reverse procedure to install.



Convection Oven Panel Shown



KICK PANEL (24" & 30" OVENS)



⚠ WARNING

Shut off the gas before servicing the unit and follow lockout / tagout procedures.

1. Lift up on kick panel and rotate down 90°.
2. Remove screws securing kick panel mounting brackets (2) to the oven and remove kick panel.
3. Reverse procedure to install.

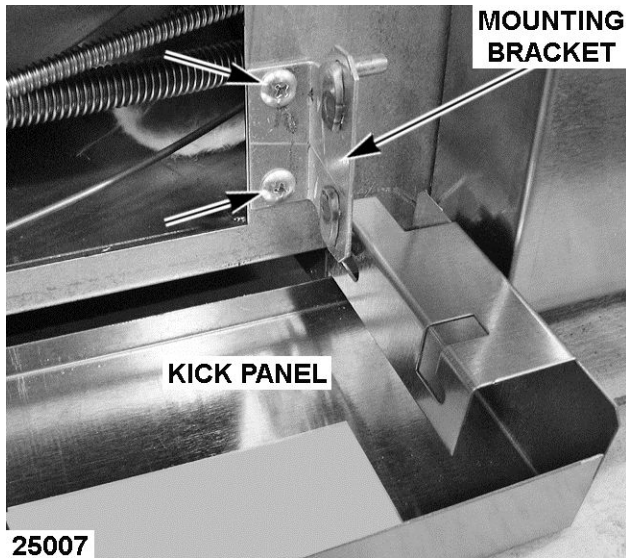

Fig. 9

BULL NOSE

1. Turn top burners and griddle off.
2. Remove front row of top burner grates on ranges with open top burners.
3. Remove all screws securing bull nose to range. The total number of screws depend on the width of the range.
4. Lift bull nose off range.

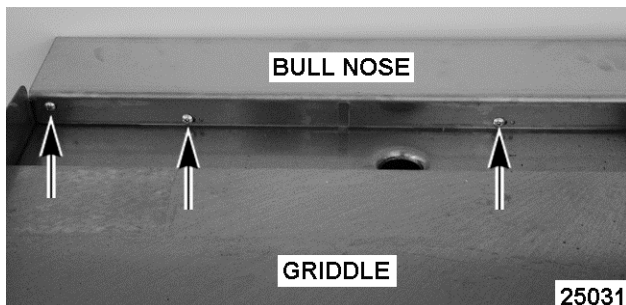

Fig. 10

5. Reverse procedure to install.

GRIDDLE CONTROL BRACKET (PREVIOUS PRODUCTION)

NOTE: The information in this section applies only to production built up to 5/12/19 for Manual Griddles models starting at Serial Number 481949646. Production built up to 2/14/19 for T-stat Griddles models Serial Number 481938361.



⚠ WARNING

Disconnect the electrical power to the machine and follow lockout / tagout procedures.



⚠ WARNING

Shut off the gas before servicing the unit and follow lockout / tagout procedures.

⚠ WARNING

All gas joints disturbed during servicing must be checked for leaks. Check with a soap and water solution (bubbles). Do not use an open flame.

1. Remove BULL NOSE.
2. Remove CONTROL BRACKET COVER.
3. If installed, remove compression nut on the flexible tubing gas line that supplies gas to the manifold on the adjacent open top burner section.

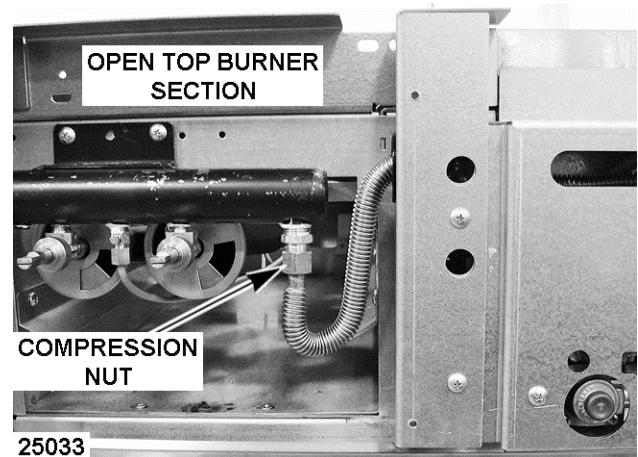

Fig. 11

4. Loosen the recessed screws (4) through the access holes on the two manifold cover brackets (L & R) that secure the control bracket to the oven. The bracket mounting holes are keyed for removal of the control bracket.

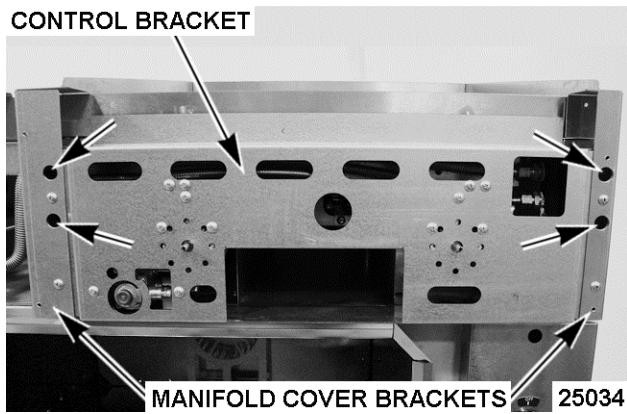

Fig. 12

5. Lift the control bracket up and tilt forward to remove bracket from mounting screws.
6. Partially install the grease drawer leaving enough of the drawer extended to support the control bracket while servicing.



Fig. 13

7. Griddle controls are now accessible for removal.
 - A. If replacing control bracket, remove screws securing griddle controls to bracket.
 - B. Remove manifold cover brackets (L & R) from each end of the control bracket as necessary (2 screws for each bracket).
8. Reverse procedure to install and check for proper operation.

CONTROLLED - CURRENT PRODUCTION

NOTE: The information in this section applies only to current production starting on 5-13-19 for Manual Griddles models starting at Serial Number 481949647. Starting on 2-15-19 for T-stat Griddles models Serial Number 481938362.



WARNING

Disconnect the electrical power to the machine and follow lockout / tagout procedures.

1. Remove GRIDDLE MANIFOLD COVER (CURRENT PRODUCTION).
2. Remove BULL NOSE.
3. Remove end caps (1, Fig. 14) on both sides.
4. Remove bracket mounting screws. Two screws in each of the following locations:
 - Right side mounting screws (2, Fig. 14).

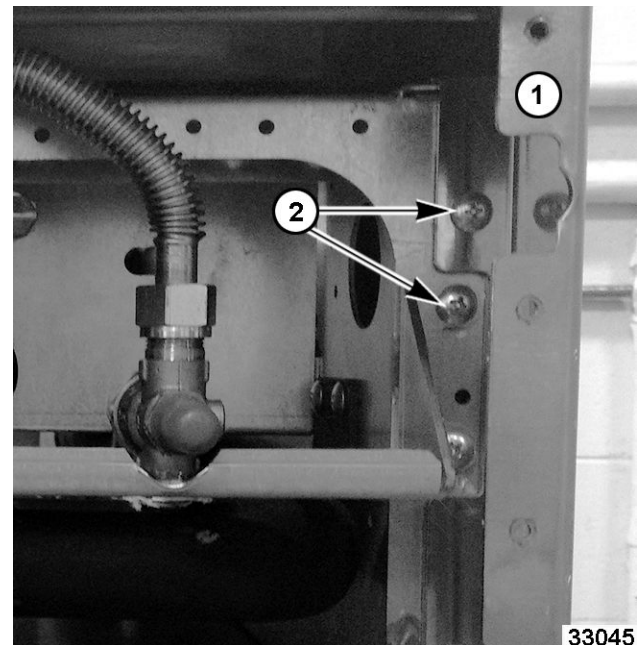

Fig. 14

- Left side mounting screws (Fig. 15).

GRIDDLE CONTROL BRACKET (THERMOSTACTICALLY)



Fig. 15

5. Pull bracket (1, Fig. 16) forward.

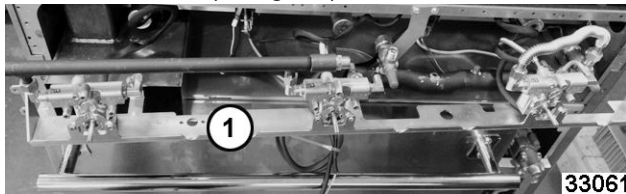

Fig. 16

6. Reverse procedure to install.

STANDARD OVEN PILOT ASSEMBLY AND THERMOCOUPLE



⚠ WARNING

Shut off the gas before servicing the unit and follow lockout / tagout procedures.

⚠ WARNING

All gas joints disturbed during servicing must be checked for leaks. Check with a soap and water solution (bubbles). Do not use an open flame.

1. Remove bottom oven rack(s) and rack guides.

2. Remove cavity bottom by lifting up and sliding out.
3. Remove screws securing oven pilot assembly to burner carrier.

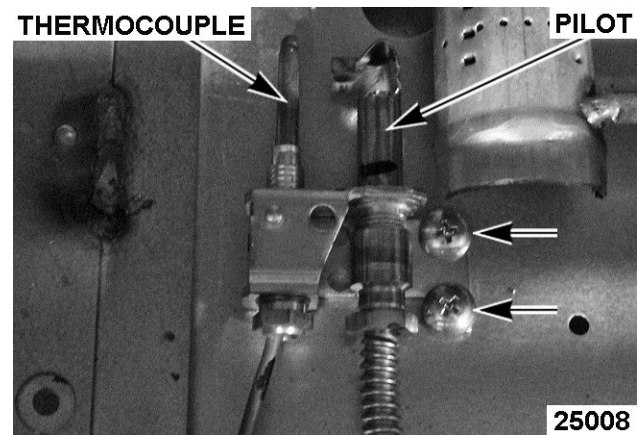

Fig. 17

4. Lower the KICK PANEL (24" & 30" OVENS).
5. Pull oven pilot assembly out through opening in lower oven frame.
6. If replacing thermocouple only, remove thermocouple from oven pilot assembly and gas safety valve. Continue to last step.

NOTICE

When installing, do not bend and kink the capillary tube or damage to the component may occur.

7. If replacing oven pilot assembly, remove pilot tubing and thermocouple from oven pilot assembly.
8. Reverse procedure to install and check for proper operation.

STANDARD OVEN BURNER



⚠ WARNING

Shut off the gas before servicing the unit and follow lockout / tagout procedures.

⚠ WARNING

All gas joints disturbed during servicing must be checked for leaks. Check with a soap and water solution (bubbles). Do not use an open flame.

1. Lower the KICK PANEL (24" & 30" OVENS).

2. Hold the tab on burner carrier with pliers to support it then remove compression nut from burner elbow fitting to disconnect gas supply tubing.
3. Remove screws securing burner carrier to oven frame.

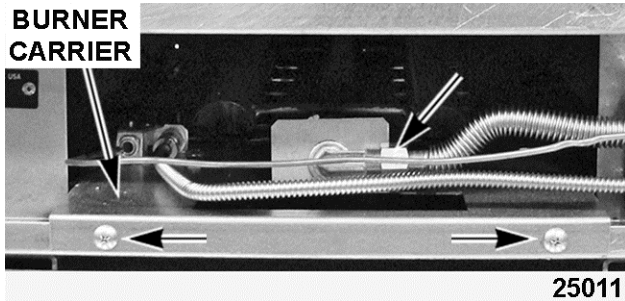

Fig. 18

4. Pull burner carrier out through opening in lower oven frame enough to access the oven pilot assembly.
5. Remove screws securing oven pilot assembly to burner carrier. Move oven pilot assembly away from burner.

NOTICE

Do not bend and kink the capillary tube or damage to the control may occur.

6. Pull burner carrier with burner attached out from oven.
7. Remove screws securing burner to the burner carrier.

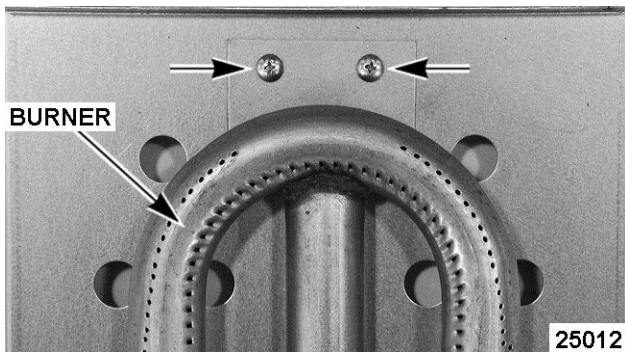

Fig. 19

8. Slide oven burner off the burner nozzle to remove.
9. Reverse procedure to install.
10. Perform BURNER AIR SHUTTER ADJUSTMENT.

STANDARD OVEN THERMOSTAT (24" OVEN)



WARNING

Shut off the gas before servicing the unit and follow lockout / tagout procedures.

WARNING

All gas joints disturbed during servicing must be checked for leaks. Check with a soap and water solution (bubbles). Do not use an open flame.

1. Pull out crumb tray.
2. Remove GRIDDLE MANIFOLD COVER (PREVIOUS PRODUCTION).
3. Remove oven thermostat knob.
4. Remove screw securing thermostat cover to oven frame.



Fig. 20

5. Remove compression nut from elbow fitting at the rear of thermostat.
6. Remove screws securing thermostat to mounting flange.



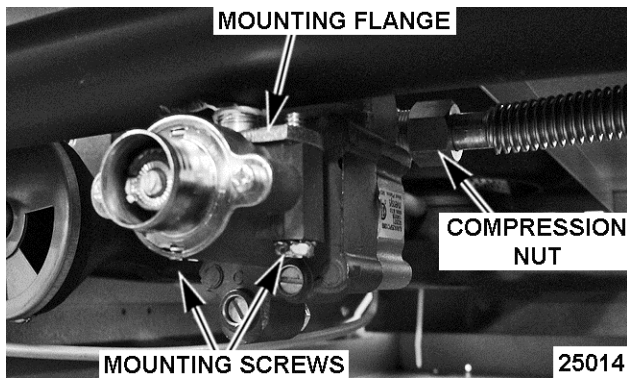

Fig. 21

- A. Inspect mounting flange and gasket. If okay, they may be used during installation. If not okay, remove and install replacement flange.
- 7. Open oven door and remove oven racks.
- 8. Remove screws securing capillary tube mounting clips (5) inside the oven cavity.

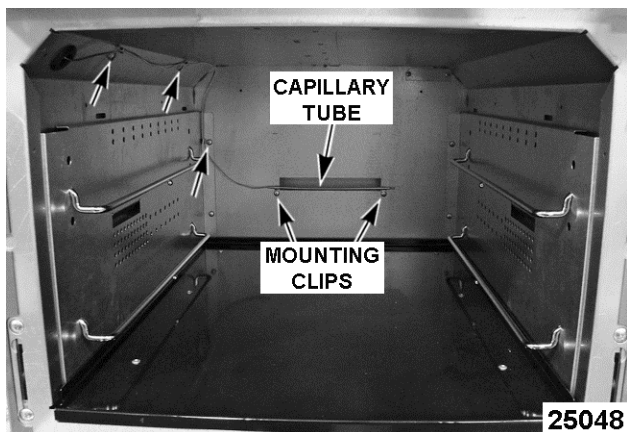

Fig. 22

NOTE: Capillary tube is permanently attached to thermostat valve.

- 9. Remove all mounting clips from capillary tube and retain for reuse.
- 10. Pull capillary tube through the hole in oven sidewall and remove thermostat from oven.
 - A. Remove insulation sleeve from capillary tube for installation on replacement thermostat capillary tube.
 - B. Note orientation of compression fitting elbow on valve body and remove for installation on replacement valve body.

⚠ WARNING

Clean pipe threads and apply thread sealant that is suitable for use with propane gases.

NOTICE

When installing, do not bend and kink the capillary tube or damage to the control may occur.

- 11. Reverse procedure to install and check for proper operation.

STANDARD OVEN THERMOSTAT (30" OVEN)



⚠ WARNING

Shut off the gas before servicing the unit and follow lockout / tagout procedures.

⚠ WARNING

All gas joints disturbed during servicing must be checked for leaks. Check with a soap and water solution (bubbles). Do not use an open flame.

- 1. Open oven door and remove oven racks.
- 2. Remove screws securing capillary tube mounting clips (5) inside the oven cavity.

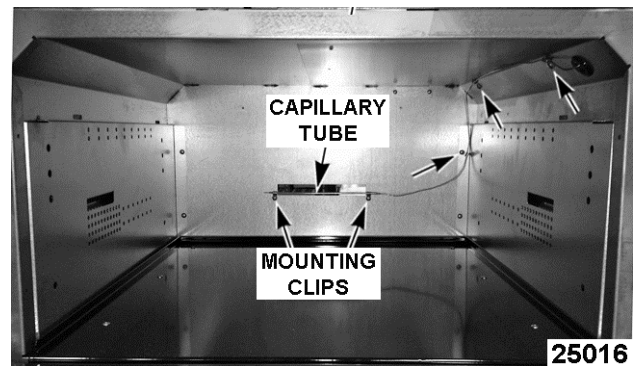

Standard 30" oven

NOTE: Capillary tube is permanently attached to thermostat.

- 3. Remove all mounting clips from capillary tube and retain for reuse.
- 4. Remove CONTROL PANEL (30" OVENS).
- 5. Remove compression nuts from thermostat fittings (front & rear).
- 6. Remove screws securing thermostat to mounting bracket.



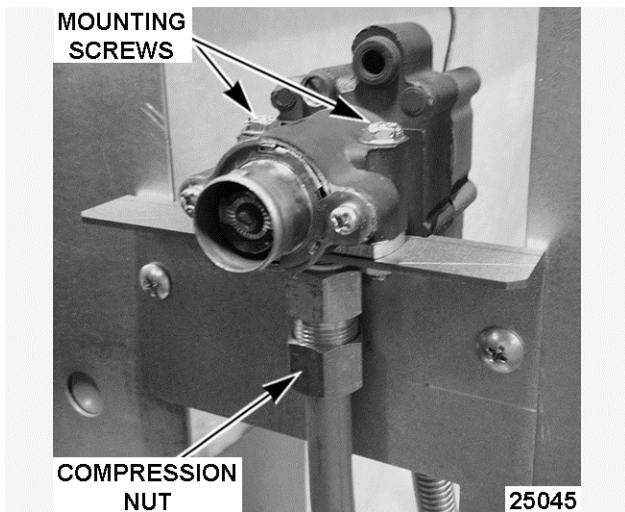

Fig. 24

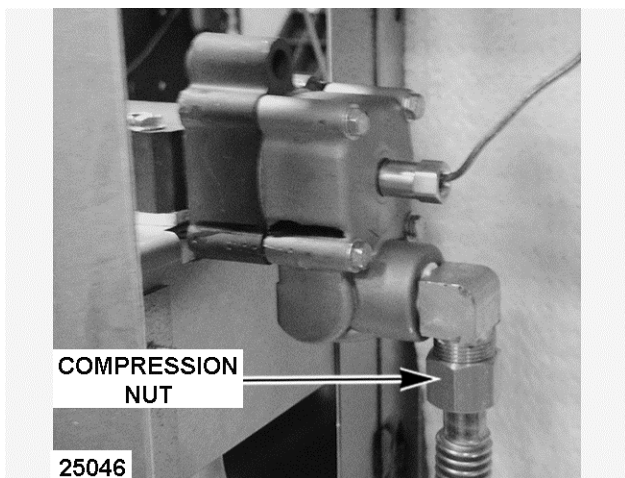

Fig. 25

7. Remove gas line tubing from thermostat.
8. Pull capillary tube through the hole in oven sidewall and remove thermostat from oven.
 - A. Note orientation of compression fittings on thermostat body and remove for installation on replacement valve body.

⚠ WARNING

Clean pipe threads and apply thread sealant that is suitable for use with propane gases.

NOTICE

When installing, do not bend and kink the capillary tube or damage to the control may occur.

NOTE: When installing thermostat capillary tube, push any insulation back through grommet and remove loose insulation from oven cavity.

9. Reverse procedure to install and check for proper operation.

CONVECTION OVEN PILOT ASSEMBLY AND THERMOCOUPLE



⚠ WARNING

Disconnect the electrical power to the machine and follow lockout / tagout procedures.



⚠ WARNING

Shut off the gas before servicing the unit and follow lockout / tagout procedures.

⚠ WARNING

All gas joints disturbed during servicing must be checked for leaks. Check with a soap and water solution (bubbles). Do not use an open flame.

1. Lower the KICK PANEL (24" & 30" OVENS).
2. Remove screws securing burner carrier to oven frame.

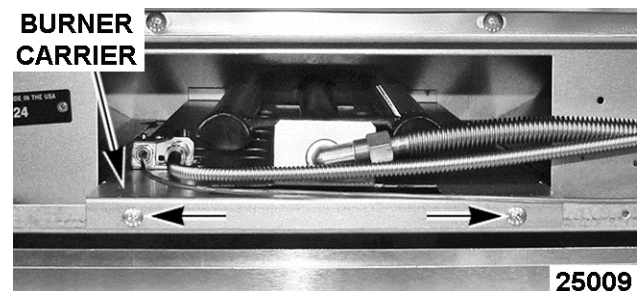

Fig. 26

3. Pull burner carrier out through opening in lower oven frame enough to access the oven pilot assembly.

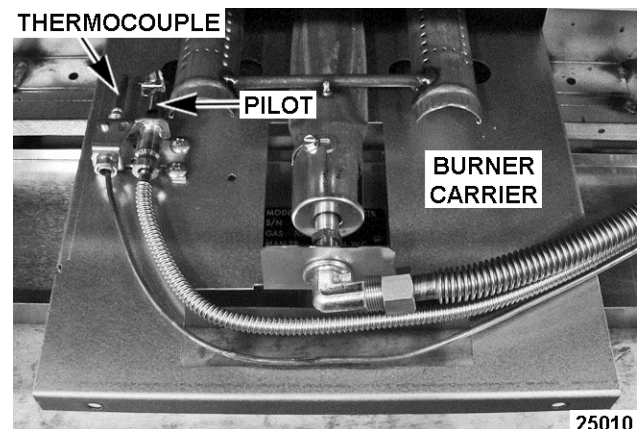

Fig. 27



- If replacing thermocouple only, remove thermocouple from oven pilot assembly.

NOTICE

When installing, do not bend and kink the capillary tube or damage to the component may occur.

- Remove CONTROL PANEL (30" OVENS).
 - Remove thermocouple from gas safety valve and remove thermocouple from oven. Continue to last step.
- If replacing oven pilot assembly, remove pilot tubing and thermocouple from oven pilot assembly.
 - Remove screws securing oven pilot assembly to burner carrier.
 - Reverse procedure to install and check for proper operation.

- Pull burner carrier out through opening in lower oven frame enough to access the oven pilot assembly and burner elbow fitting.
- Hold the tab on burner carrier with pliers to support then remove compression nut from burner elbow fitting.
- Remove screws securing oven pilot assembly to burner carrier. Move pilot assembly away from burner.

NOTICE

Do not bend and kink the capillary tube or damage to the control may occur.

- Pull burner carrier with burner attached out from oven.
- Remove screws securing burner to the burner carrier.

CONVECTION OVEN BURNER



WARNING

Disconnect the electrical power to the machine and follow lockout / tagout procedures.



WARNING

Shut off the gas before servicing the unit and follow lockout / tagout procedures.

WARNING

All gas joints disturbed during servicing must be checked for leaks. Check with a soap and water solution (bubbles). Do not use an open flame.

- Lower the KICK PANEL (24" & 30" OVENS).
- Remove screws securing burner carrier to oven frame.

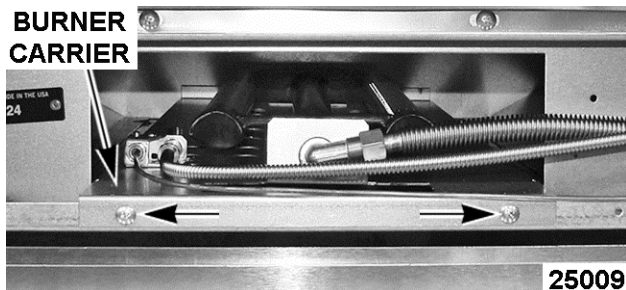

Fig. 28

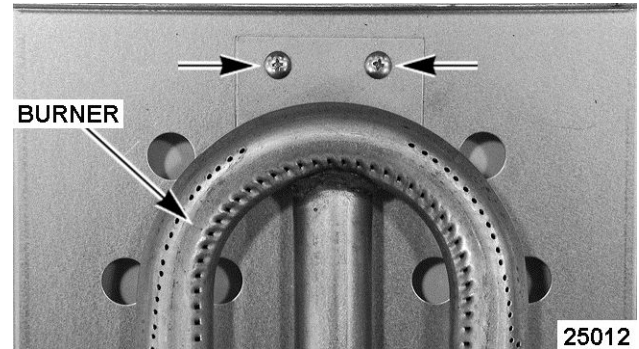

Fig. 29

- Slide oven burner off the burner nozzle to remove.
- Reverse procedure to install.
- Perform BURNER AIR SHUTTER ADJUSTMENT.



CONVECTION OVEN THERMOSTAT VALVE



⚠ WARNING

Disconnect the electrical power to the machine and follow lockout / tagout procedures.



⚠ WARNING

Shut off the gas before servicing the unit and follow lockout / tagout procedures.

⚠ WARNING

All gas joints disturbed during servicing must be checked for leaks. Check with a soap and water solution (bubbles). Do not use an open flame.

1. Remove CONTROL PANEL (30" OVENS).
2. Remove compression nuts from thermostat valve fittings.
3. Remove screws securing thermostat valve to mounting bracket.

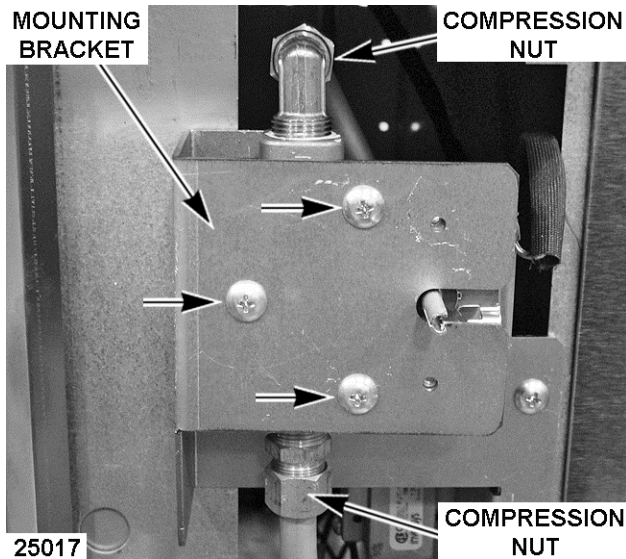

Fig. 30

4. Remove thermostat valve from gas line tubing.
5. Remove oven racks.
6. Open oven door and remove screws securing capillary tube mounting clips (4) at the top of oven cavity.

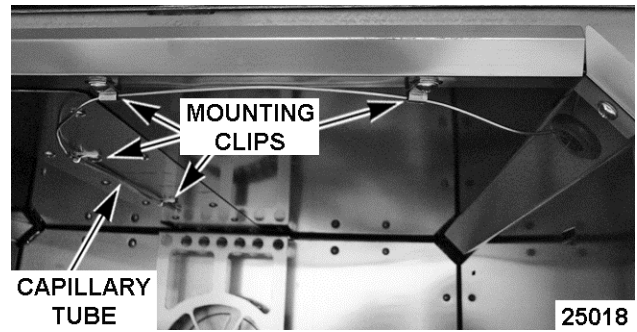

Fig. 31

NOTE: Capillary tube is permanently attached to thermostat valve.

7. Remove all mounting clips from capillary tube and retain for reuse.
8. Pull capillary tube through the hole in oven sidewall and remove thermostat valve from oven.
 - A. Remove insulation sleeve from capillary tube for installation on replacement thermostat capillary tube.
 - B. Note orientation of compression fittings on valve body and remove for installation on replacement valve body.

⚠ WARNING

Clean pipe threads and apply thread sealant that is suitable for use with propane gases.

NOTICE

When installing, do not bend and kink the capillary tube or damage to the control may occur.

NOTE: When installing thermostat capillary tube, push any insulation back through grommet and remove loose insulation from oven cavity.

9. Reverse procedure to install and check for proper operation.

CONVECTION OVEN BLOWER AND MOTOR



⚠ WARNING

Disconnect the electrical power to the machine and follow lockout / tagout procedures.

1. Remove cover from electrical junction box at the rear of range.
2. Disconnect motor wiring at junction box.



3. Loosen screw securing armored cable to junction box.
4. Remove oven racks and rack guides from oven.
5. Place cardboard over the oven cavity bottom to protect it during motor removal.
6. Remove screws securing motor mount panel to the oven. Pull the assembly out from the oven.

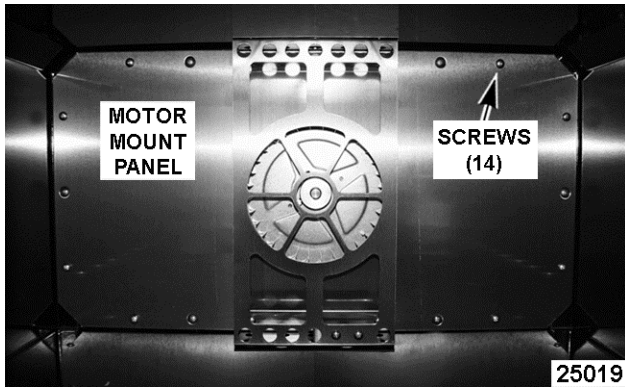

Fig. 32

7. Remove screws (4) securing blower cover to motor mount panel.

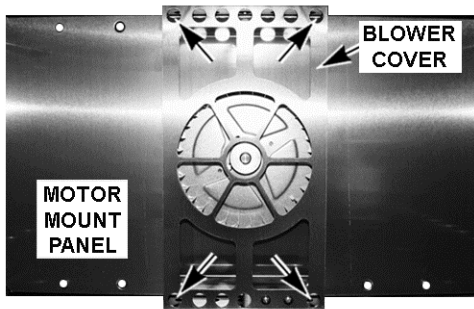

Fig. 33

8. Loosen bolts (2) securing blower to motor shaft then remove blower.
9. If replacing blower only, proceed to last step. If replacing motor, continue with procedure.
10. Remove mounting nuts and spacers securing motor mounting brackets (2) to motor mount panel.

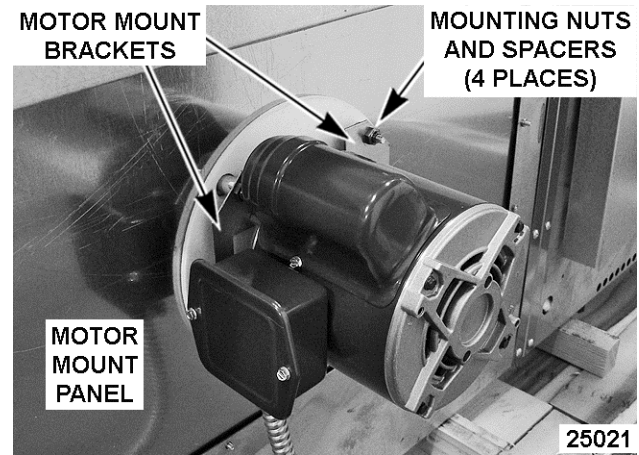

Fig. 34

- A. Remove motor mounting brackets from motor for reuse.
 - B. Remove cover from motor junction box, disconnect wires and remove armored cable from motor junction box.
 - C. Inspect the motor insulation located between the motor mounting brackets and the motor mount panel. Replace if damaged.
11. Install motor mounting brackets and armored cable onto replacement motor.
 12. Reverse procedure to install and check for proper operation.

BURNER ORIFICE (STANDARD AND CONVECTION OVENS)

1. Access burner for the type of oven being serviced as outlined under STANDARD OVEN BURNER or CONVECTION OVEN BURNER.
2. Remove the orifice spud (1, Fig. 35) from hood (2, Fig. 35).

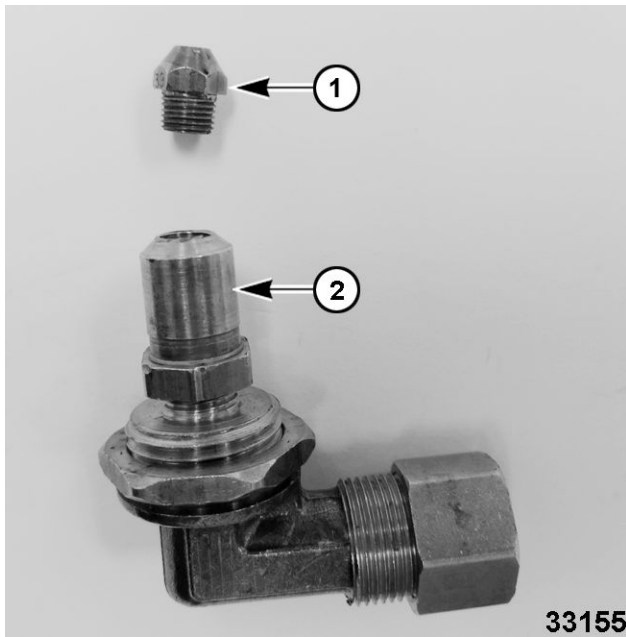

Fig. 35

NOTE: There are two types of orifices. The orifice used in the oven has a spud that screws into a threaded hood (1, Fig. 36). The open top and griddle uses a pre-drilled orifice hood (2, Fig. 36).

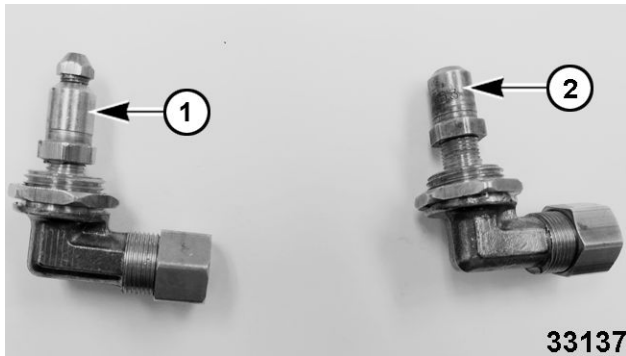

Fig. 36

3. Perform BURNER NOZZLE CHECK.
4. Reverse procedure to install.
5. Check for proper operation.

GAS SAFETY VALVE (STANDARD AND CONVECTION OVENS)



⚠ WARNING

Disconnect the electrical power to the machine and follow lockout / tagout procedures.



⚠ WARNING

Shut off the gas before servicing the unit and follow lockout / tagout procedures.

⚠ WARNING

All gas joints disturbed during servicing must be checked for leaks. Check with a soap and water solution (bubbles). Do not use an open flame.

1. Remove CONTROL PANEL (30" OVENS) on standard and convection ovens or lower the KICK PANEL (24" & 30" OVENS) on standard 24" ovens.
2. Remove pilot tubing and thermocouple from gas safety valve.
3. Remove inlet and outlet gas lines from gas safety valve.

Gas Safety Valve on Standard 24" Oven Shown in Fig. 37

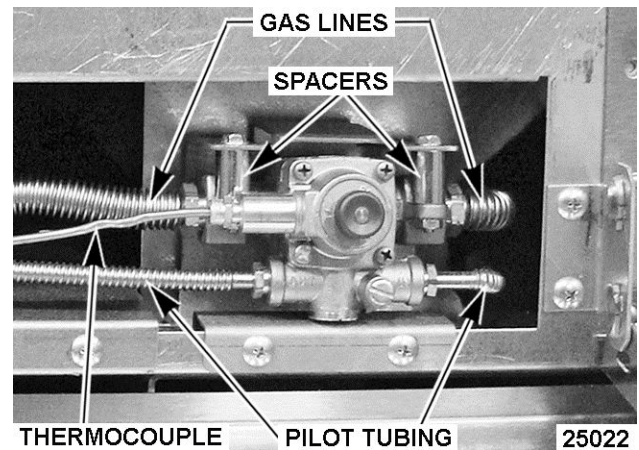

Fig. 37

Gas Safety Valve on 30" Oven Shown in Fig. 38



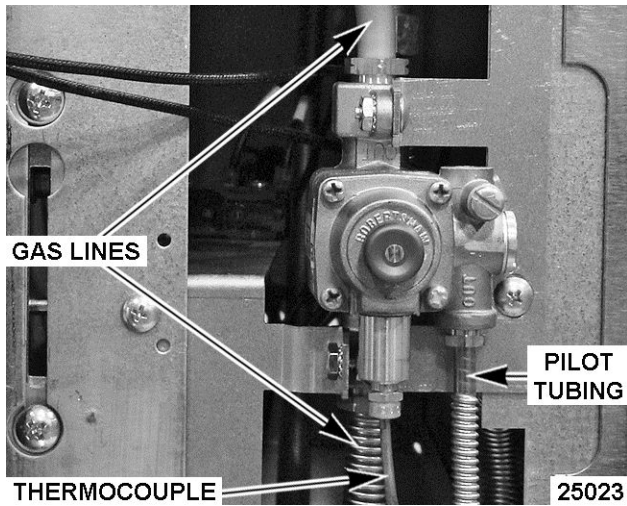

Fig. 38

NOTE: Safety valve replacement is identical on 30 inch wide standard ovens.

4. Remove screws securing gas safety valve to mounting bracket and remove the valve. On 24" standard ovens, spacers are installed between the valve and mounting bracket. Retain spacers for reuse. Spacer locations shown in picture [25022 "Gas Safety Valve on Standard 24" Oven"](#).
5. Remove compression fittings and tubing from gas safety valve for installation on replacement valve.

⚠ WARNING

Clean pipe threads and apply thread sealant that is suitable for use with propane gases.

6. Reverse procedure to install and check for proper operation.

TOP BURNER PILOT VALVE



⚠ WARNING

Disconnect the electrical power to the machine and follow lockout / tagout procedures.



⚠ WARNING

Shut off the gas before servicing the unit and follow lockout / tagout procedures.

⚠ WARNING

All gas joints disturbed during servicing must be checked for leaks. Check with a soap and water solution (bubbles). Do not use an open flame.

1. On the module section being serviced, loosen set screw on top burner knobs and remove knobs from manual valve.
2. Remove [GRIDDLE MANIFOLD COVER \(PREVIOUS PRODUCTION\)](#).
3. Remove compression nut securing pilot tube to pilot valve.
4. Remove pilot valve from the manifold.

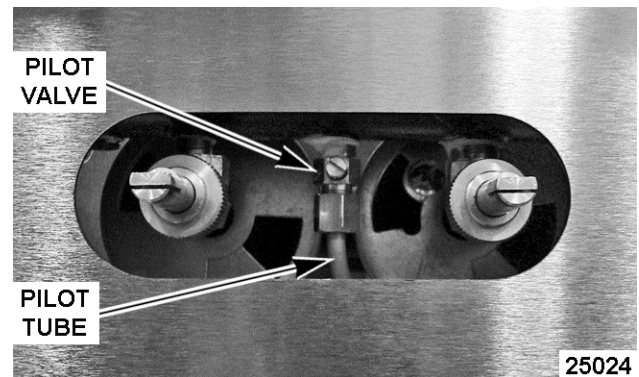

Fig. 39

5. Reverse procedure to install.

⚠ WARNING

Clean pipe threads and apply thread sealant that is suitable for use with propane gases.

NOTICE

Do not over tighten pilot valve or damage to the threads may occur.

6. Check [PILOT FLAME HEIGHT](#) under Open Top Burner Adjustment.



TOP BURNER ASSEMBLY



⚠ WARNING

Disconnect the electrical power to the machine and follow lockout / tagout procedures.



⚠ WARNING

Shut off the gas before servicing the unit and follow lockout / tagout procedures.

⚠ WARNING

All gas joints disturbed during servicing must be checked for leaks. Check with a soap and water solution (bubbles). Do not use an open flame.

1. Remove top burner grates (front and rear) from the module section being serviced.
2. Remove pilot from mounting clip on the top burner assembly. Move pilot away from burner assembly.

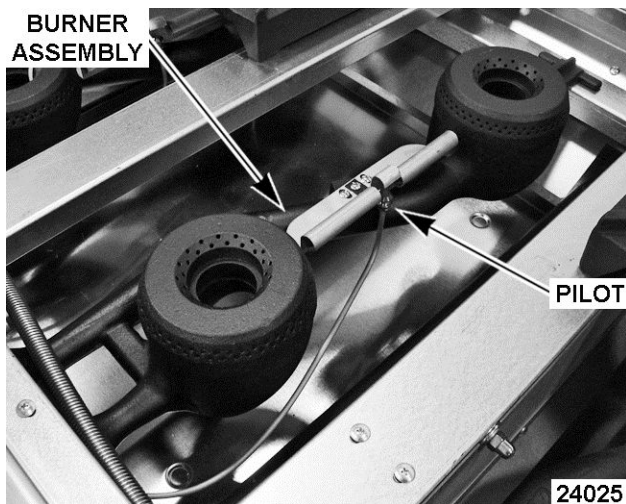

Fig. 40

3. Lift burner heads off the top burner assembly.
4. Lift the top burner assembly at the rear and pull away from manual valves.
 - A. Remove pilot mounting clip and flash tube from the top burner assembly for reuse on replacement burner assembly.
5. Reverse procedure to install.

NOTE: When installing, ensure that each end of the flash tube is aligned with the ignition ports on the burner “venturi” casting for proper burner ignition.

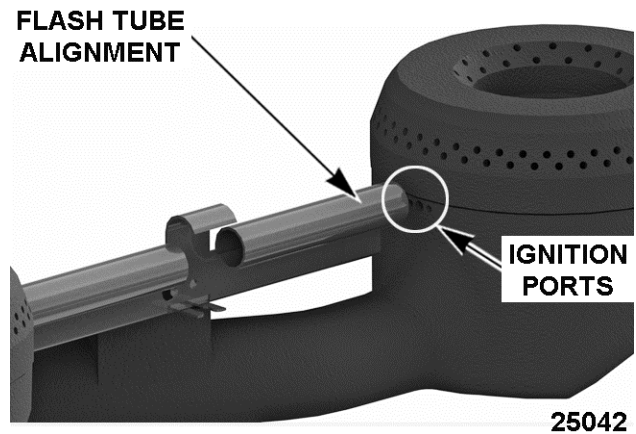

Fig. 41

6. Check for proper operation.
7. Verify BURNER AIR SHUTTER ADJUSTMENT.

TOP BURNER CONTROL VALVE



⚠ WARNING

Disconnect the electrical power to the machine and follow lockout / tagout procedures.



⚠ WARNING

Shut off the gas before servicing the unit and follow lockout / tagout procedures.

⚠ WARNING

All gas joints disturbed during servicing must be checked for leaks. Check with a soap and water solution (bubbles). Do not use an open flame.

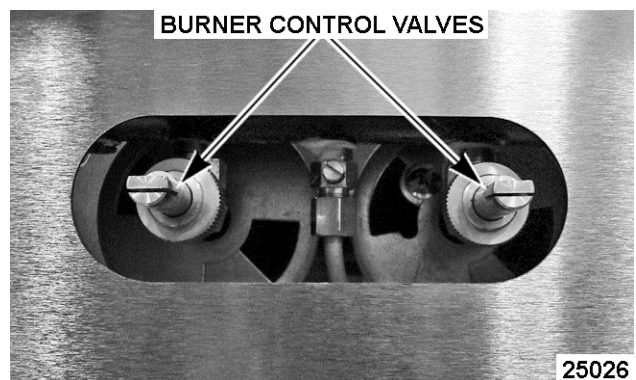

Fig. 42

1. Remove GRIDDLE MANIFOLD COVER (PREVIOUS PRODUCTION).
2. Remove TOP BURNER ASSEMBLY.

3. Remove TOP BURNER PILOT VALVE.
4. Remove top burner control valve from the manifold.
5. Inspect the top control valve for wear and damage, replace as necessary.
6. Reverse procedure to install.

⚠ WARNING

Clean pipe threads and apply thread sealant that is suitable for use with propane gases.

NOTE: When installing, ensure top burner control valve is aligned and centered in the burner assembly opening. The valve must be perpendicular to the manifold.

7. Check for proper operation.

TOP BURNER ORIFICE HOOD

1. Access top burner orifice hood as outlined under TOP BURNER ASSEMBLY.
2. Remove the orifice hood from top burner control valve.
3. Reverse procedure to install.
4. Check for proper operation.

OVEN DOOR

Removal

1. Remove CONTROL PANEL (30" OVENS).

NOTE: Removal of control panel is to provide additional space on the right side of door to ease door removal and installation.

2. Lower KICK PANEL (24" & 30" OVENS).
3. Fully open the oven door.

⚠ WARNING

When servicing hinges, use cut resistant glove with additional padding to compress hinge to insert bolt into slot or remove bolt after door is removed.

4. Insert a tight fitting 1" long bolt/screw (size depends on door revision) into each door hinge slot at the top of the spring loaded hinge.

⚠ WARNING

Use the tightest fitting bolts / screws to relieve spring tension on door hinge during removal and installation.

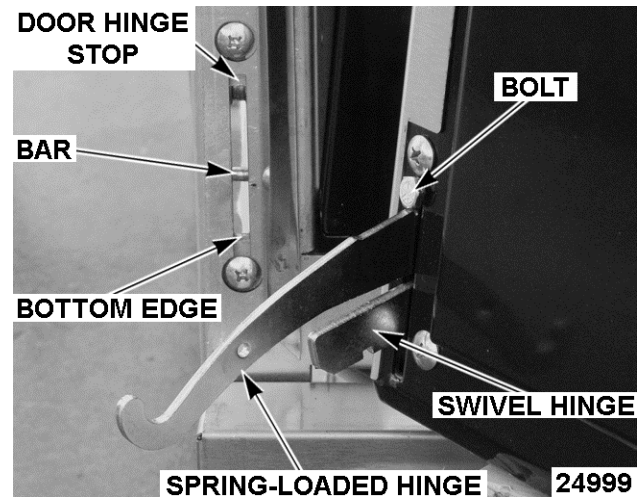

Fig. 43

5. Close door leaving enough space to clear the oven gas manifold cover during removal. As the door approaches this position, you should notice a decrease in the spring tension on the door.
6. Remove door as follows:
 - A. Hold door at bottom corners then lift the door up and out to disengage the hinges.
 - B. The notch on swivel hinge must release from bottom edge of the door hinge stop to remove door. As needed, lift up on the swivel hinges using forefinger to aid in releasing.
 - C. The spring-loaded hinge must release from the roller inside the slot on door hinge stop to remove door.
7. If replacing door or door spring hinge, position the door face down. Press down on hinge enough to relieve spring force then remove bolt from door hinge slot.

Installation

1. Compress each spring-loaded hinge enough to insert the bolt into the slot at top of hinge.
2. Hold door at bottom corners while facing the oven cavity. Place knee on the front of door to help balance it as necessary during installation.
 - A. Using index fingers, lift swivel hinges until they touch the spring-loaded hinges and hold in place.



- B. Tilt the top of door toward the oven so that the swivel hinge is at a slightly downward angle to pass between the bar and bottom edge of door hinge stop.
- C. Insert hinges into the slots making sure that the spring-loaded hinges go above the bar to catch on the roller and the swivel hinges go underneath the bar to catch on the bottom edge of door hinge slot.
- D. Lower the door and position it as necessary to engage the swivel hinge slots with the bottom edge of both door hinge slots.



Fig. 44

- 3. Fully open door to check operation. If bottom edge of door rubs the front edge of cavity bottom then the swivel hinge is not engaged as described.
 - A. To seat the swivel hinge, open door approximately 30° and pull in the same direction on the door handle. The hinge should drop into place.
- 4. Open door and check operation. If okay, remove bolts and close door. If not okay, remove door and repeat installation procedure.
- 5. On convection ovens, verify door switch is operating properly.
- 6. Reinstall oven control panel.
- 7. Raise kick panel.

GAS PRESSURE REGULATOR



⚠ WARNING

Disconnect the electrical power to the machine and follow lockout / tagout procedures.



⚠ WARNING

Shut off the gas before servicing the unit and follow lockout / tagout procedures.

⚠ WARNING

All gas joints disturbed during servicing must be checked for leaks. Check with a soap and water solution (bubbles). Do not use an open flame.

⚠ WARNING

Clean pipe threads and apply thread sealant that is suitable for use with propane gases.

1. Thread regulator onto pipe hand tight with arrow pointing in direction of gas flow to the range.

REGULATOR ADJUSTMENT (BELOW CLOSING NUT)

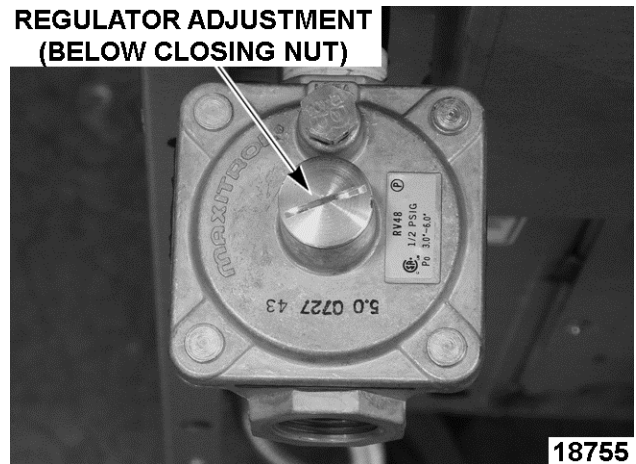

Fig. 45

2. Tighten regulator securely in horizontal position with the regulator adjustment upward as described on regulator.

NOTE: Regulator will not function properly without adjustment screw pointing upward.

3. Connect supply gas line to gas pressure regulator inlet.
4. Adjust regulator as outlined in REGULATOR ADJUSTMENT.

CONVECTION OVEN DOOR SWITCH



⚠ WARNING

Disconnect the electrical power to the machine and follow lockout / tagout procedures.

NOTE: Door switch is installed on Convection Ovens only.

1. Remove CONTROL PANEL (30" OVENS).
2. Remove single mounting nut securing door switch bracket to safety valve mounting bracket.
3. Remove screws securing door switch bracket to oven frame and remove bracket from control area.

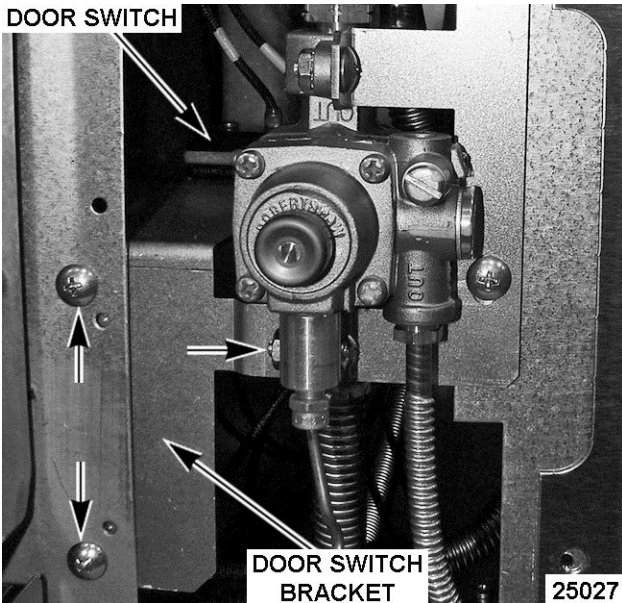

Fig. 46

4. Open door to unoperate the switch.
5. Note lead wire locations and disconnect from door switch.
6. Remove screws and mounting nuts securing door switch to door switch bracket.

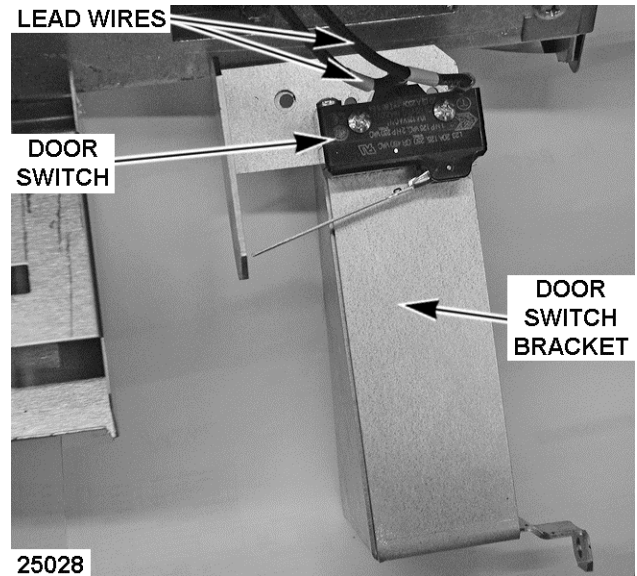

Fig. 47

7. Reverse procedure to install and check door switch for proper operation.

CONVECTION OVEN SOLENOID



⚠ WARNING

Disconnect the electrical power to the machine and follow lockout / tagout procedures.



⚠ WARNING

Shut off the gas before servicing the unit and follow lockout / tagout procedures.

⚠ WARNING

All gas joints disturbed during servicing must be checked for leaks. Check with a soap and water solution (bubbles). Do not use an open flame.

1. Remove door switch bracket as outlined under CONVECTION OVEN DOOR SWITCH. Allow bracket to rest at the bottom of control area.
2. Remove screws securing the mounting bracket that holds the safety valve, oven thermostat and the oven solenoid to the oven frame.



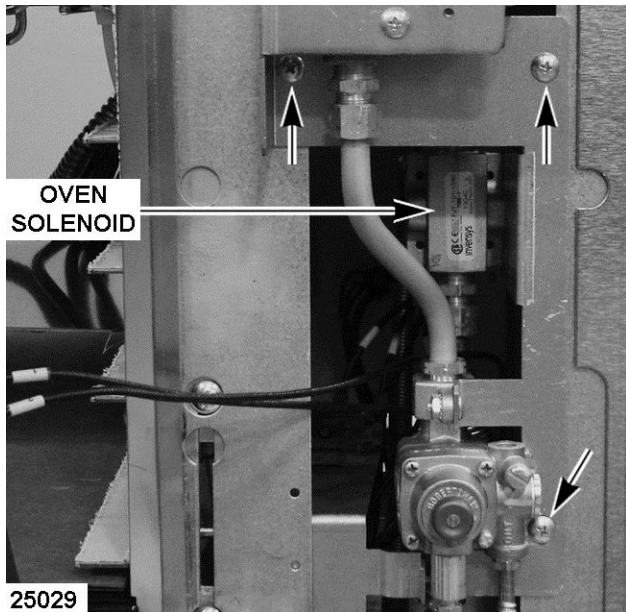

Fig. 48

3. Remove compression nuts on the inlet and outlet of solenoid.
4. Remove screws and mounting nuts securing solenoid to bracket.
5. Disconnect lead wires from solenoid.

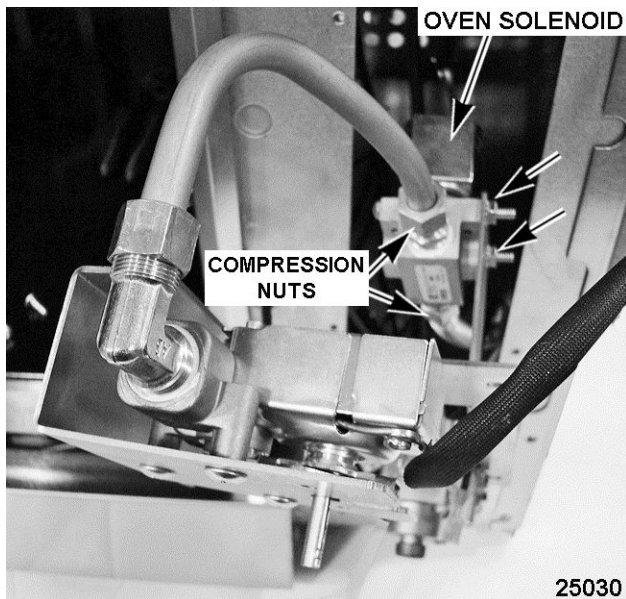

Fig. 49

6. Remove fittings from solenoid for reuse on replacement valve.

⚠ WARNING

Clean pipe threads and apply thread sealant that is suitable for use with propane gases.

7. Reverse procedure to install and check for proper operation.

GRIDDLE THERMOSTAT VALVE (PREVIOUS PRODUCTION)

NOTE: The information in this section applies only to production built up to 5/12/19 for Manual Griddles models starting at Serial Number 481949646. Production built up to 2/14/19 for T-stat Griddles models Serial Number 481938361.



⚠ WARNING

Disconnect the electrical power to the machine and follow lockout / tagout procedures.



⚠ WARNING

Shut off the gas before servicing the unit and follow lockout / tagout procedures.

⚠ WARNING

All gas joints disturbed during servicing must be checked for leaks. Check with a soap and water solution (bubbles). Do not use an open flame.

1. Remove BULL NOSE.
2. Raise griddle plate from the front and support using 4x4 blocks.
3. Pull thermostat bulb out of the holder for the thermostat valve being replaced.

NOTE: Capillary tube is permanently attached to thermostat valve.

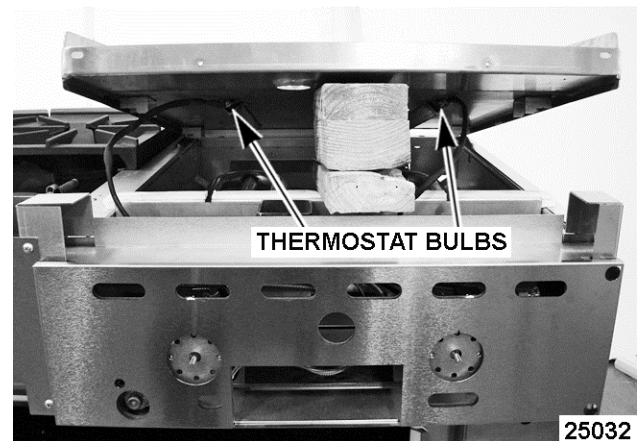

Fig. 50

4. Remove CONTROL BRACKET COVER.



5. If installed, remove compression nut on the flexible tubing gas line that supplies gas to the manifold on the adjacent open top burner section.

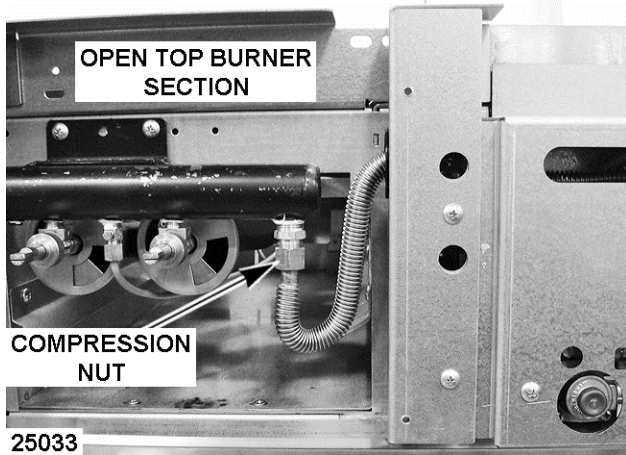

Fig. 51

6. Loosen the recessed screws (4) through the access holes on the two manifold cover brackets (L & R) that secure the control bracket to the oven. The bracket mounting holes are keyed for removal of the control bracket.

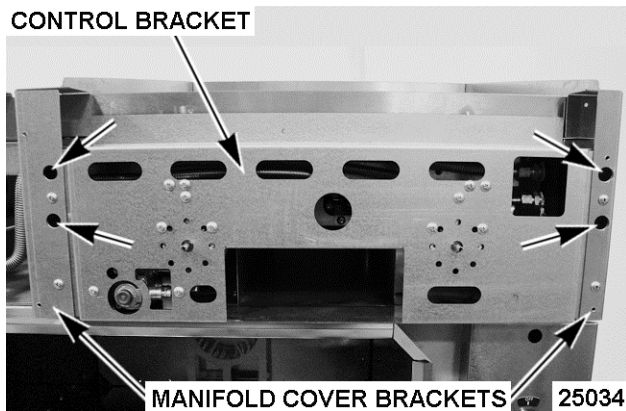

Fig. 52

7. Lift up control bracket and tilt forward to access griddle thermostat valves.
8. Partially install the grease drawer leaving enough of the drawer extended to support the control bracket while servicing.

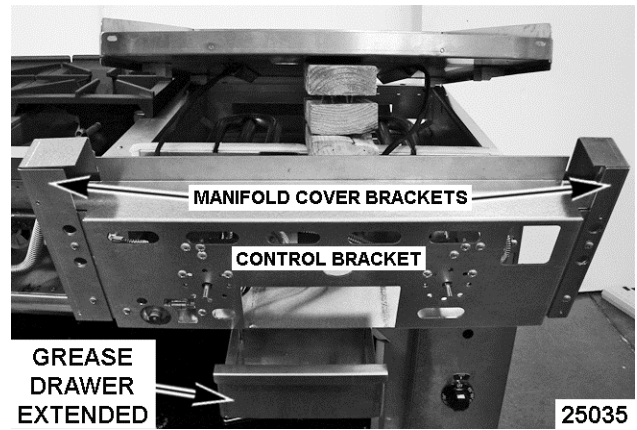

Fig. 53

9. Remove compression nuts from thermostat valve fittings for the thermostat being replaced.

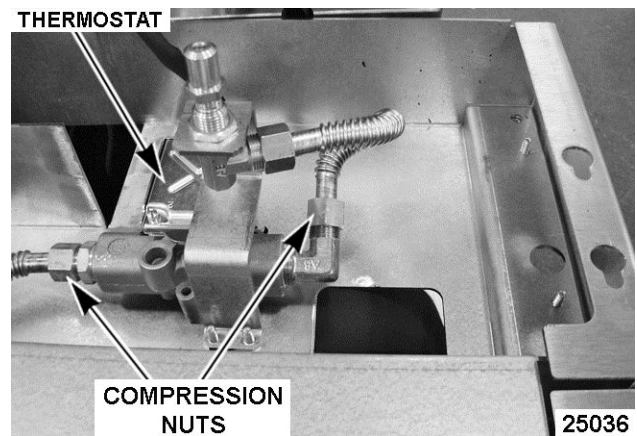

Fig. 54

10. Remove screws (3) securing thermostat valve to the control bracket and remove the thermostat valve.

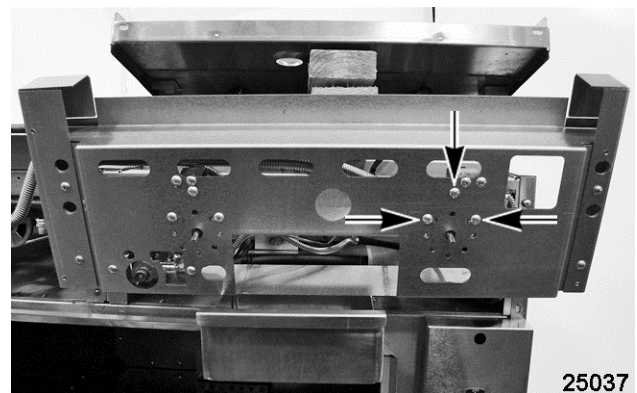

Fig. 55

- A. Note orientation of compression fittings on the thermostat valve and remove for installation on replacement valve.
- B. Remove insulation sleeve from capillary tube for installation on replacement thermostat capillary tube.



⚠ WARNING

Clean pipe threads and apply thread sealant that is suitable for use with propane gases.

NOTICE

When installing, do not bend and kink the capillary tubes or damage to the controls may occur. Ensure capillary tubes are routed properly through mounting slots before lowering the griddle or damage to the controls may occur.

NOTE: When installing, ensure orifice hood is aligned and centered in the burner assembly opening. The griddle orifice bracket must be perpendicular to the manifold.

- Reverse procedure to install and check for proper operation.

GRIDDLE THERMOSTAT VALVE (CURRENT PRODUCTION)

NOTE: The information in this section applies only to current production starting on 5-13-19 for Manual Griddles models starting at Serial Number 481949647. Starting on 2-15-19 for T-stat Griddles models Serial Number 481938362.



⚠ WARNING

Disconnect the electrical power to the machine and follow lockout / tagout procedures.



⚠ WARNING

Shut off the gas before servicing the unit and follow lockout / tagout procedures.

- Remove GRIDDLE CONTROL BRACKET (THERMOSTACTICALLY CONTROLLED - CURRENT PRODUCTION).
- Remove BULL NOSE.
- Disconnect inlet and outlet brass fittings.

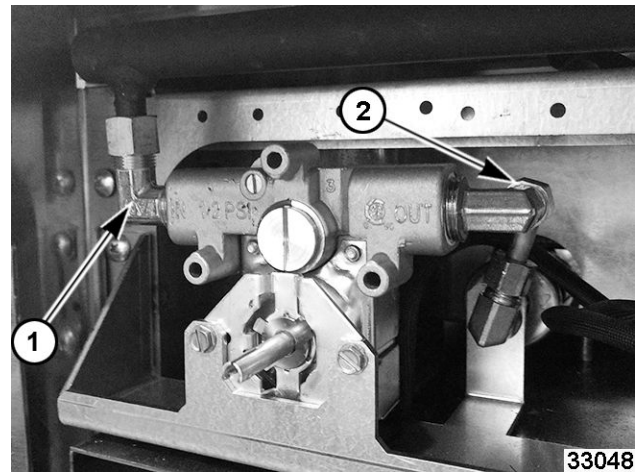

Fig. 56

- Disconnect pilot burner flex line.

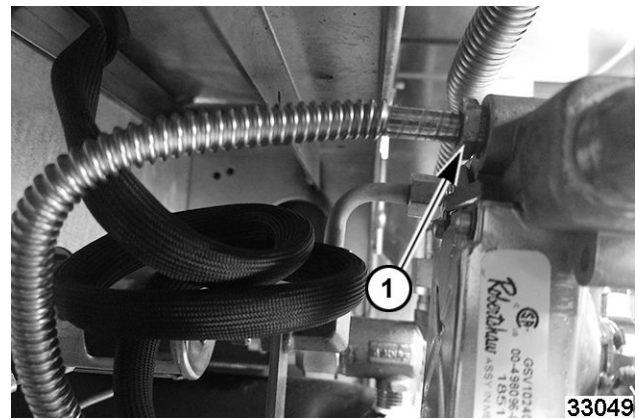

Fig. 57

- Remove thermostat mounting screws.

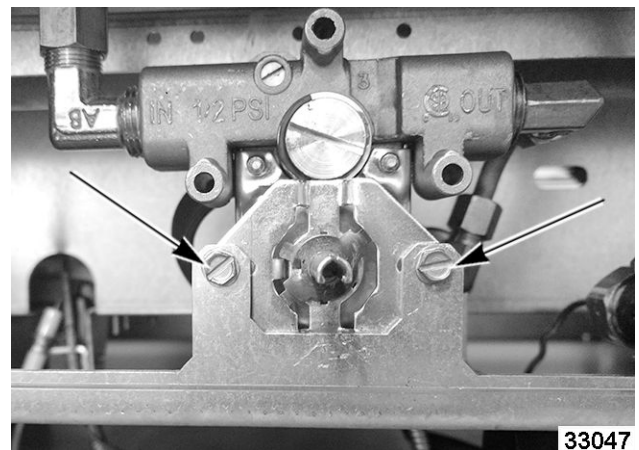

Fig. 58

- Lift griddle plate and secure with work blocks on both sides.





Fig. 59

7. Pull capillary tube out of V channel underneath griddle plate.

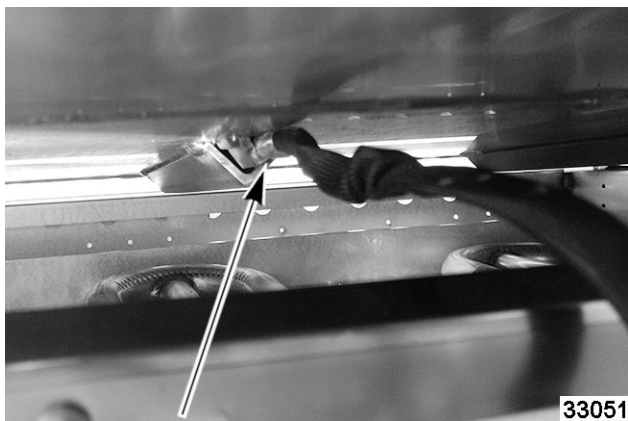

Fig. 60

8. Remove both brass fittings from old thermostat and install on new thermostat.

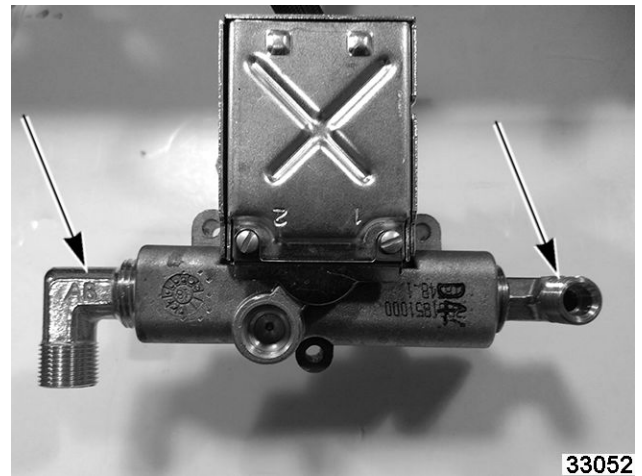

Fig. 61

9. Insert capillary bulb all the way into V channel.

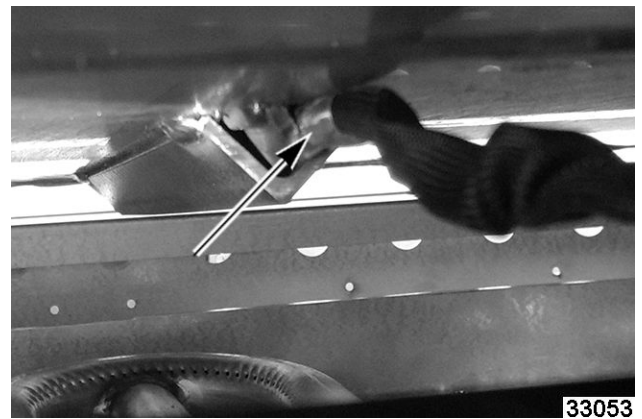

Fig. 62

NOTICE

Remaining capillary tubing should be minimized as much as possible inside the burner chamber area. Pull excess straight back and away from the burners.

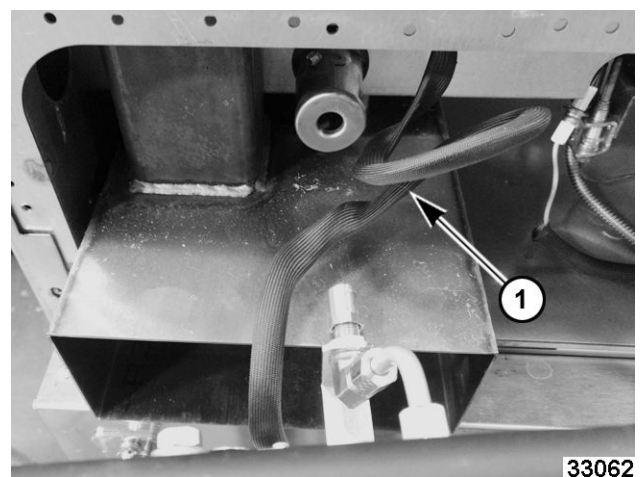

Fig. 63

10. Reverse steps 1 through step 6 to install.
11. Verify proper operation.

GRIDDLE GAS SAFETY VALVE (PREVIOUS PRODUCTION)

NOTE: The information in this section applies only to production built up to 5/12/19 for Manual Griddles models starting at Serial Number 481949646. Production built up to 2/14/19 for T-stat Griddles models Serial Number 481938361.



⚠ WARNING

Disconnect the electrical power to the machine and follow lockout / tagout procedures.



⚠ WARNING

Shut off the gas before servicing the unit and follow lockout / tagout procedures.

⚠ WARNING

All gas joints disturbed during servicing must be checked for leaks. Check with a soap and water solution (bubbles). Do not use an open flame.

1. Remove GRIDDLE CONTROL BRACKET (PREVIOUS PRODUCTION).
2. Remove pilot tubing and thermocouple from gas safety valve.
3. Remove compression nuts from gas safety valve fittings.

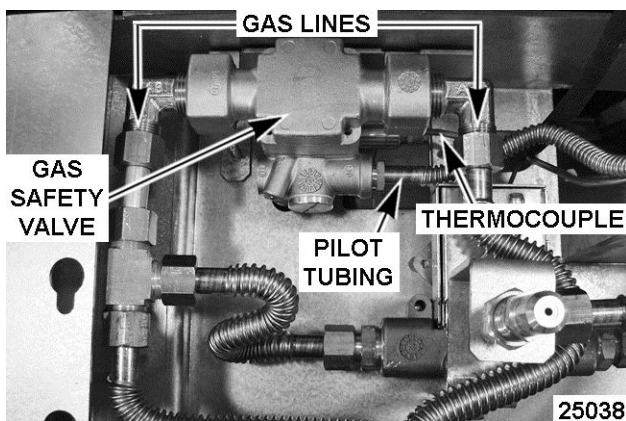

Fig. 64

4. Remove screws (2) securing gas safety valve to the control bracket and remove the valve.
 - A. Note orientation of compression fittings on the valve and remove for installation on replacement valve.

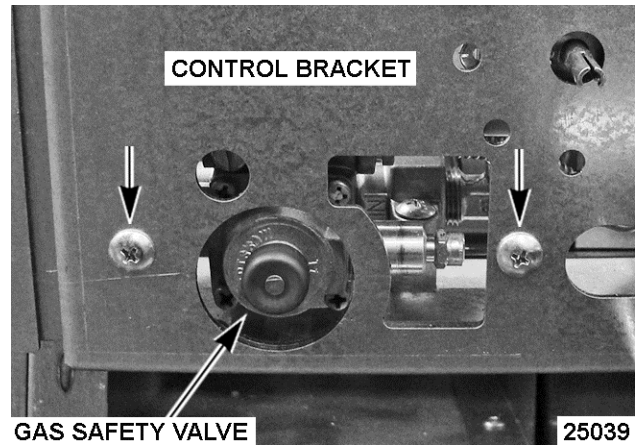

Fig. 65

NOTICE

When installing, do not bend and kink the capillary tube or damage to the control may occur.

NOTICE

Clean pipe threads and apply pipe joint compound. Any pipe joint compound used must be resistant to the reaction of propane gases.

NOTE: When installing, ensure orifice hood is aligned and centered in the burner assembly opening.

5. Reverse procedure to install and check for proper operation.

GRIDDLE SAFETY VALVE (CURRENT PRODUCTION)

NOTE: The information in this section applies only to current production starting on 5-13-19 for Manual Griddles models starting at Serial Number 481949647. Starting on 2-15-19 for T-stat Griddles models Serial Number 481938362.



⚠ WARNING

Disconnect the electrical power to the machine and follow lockout / tagout procedures.



⚠ WARNING

Shut off the gas before servicing the unit and follow lockout / tagout procedures.

1. Remove GRIDDLE MANIFOLD COVER (CURRENT PRODUCTION).
2. Remove manifold support bracket if applicable.

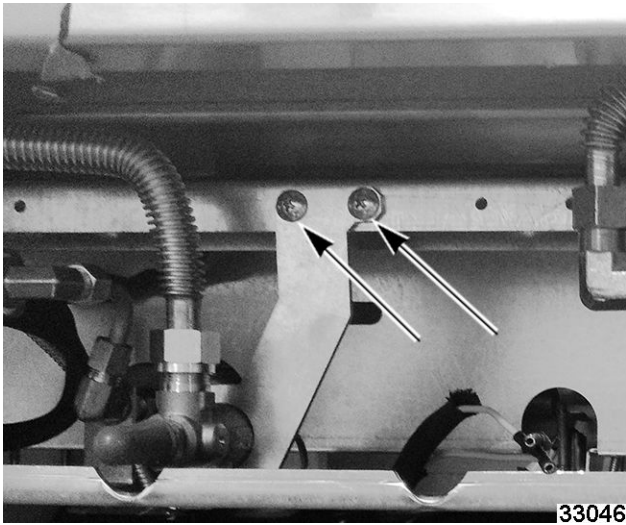

Fig. 66

3. Remove gas supply flex line.

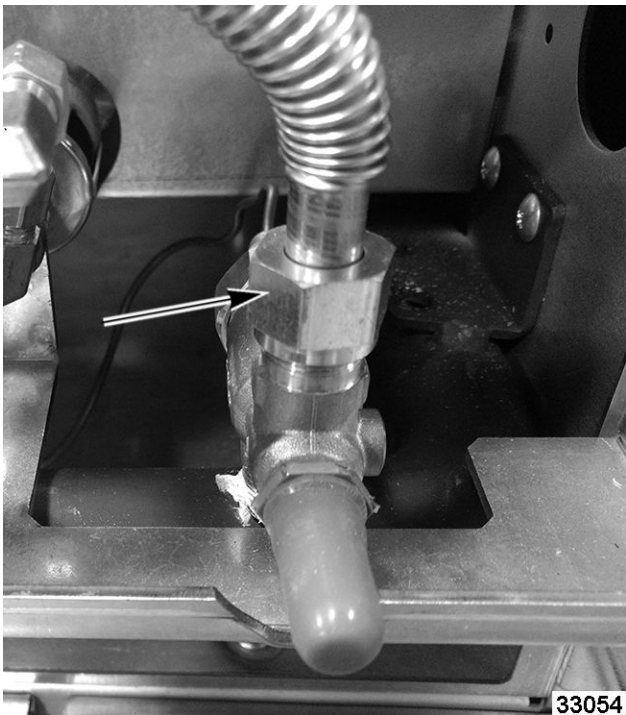

Fig. 67

4. Remove thermocouple.



Fig. 68

5. Unscrew safety valve from gas supply manifold.

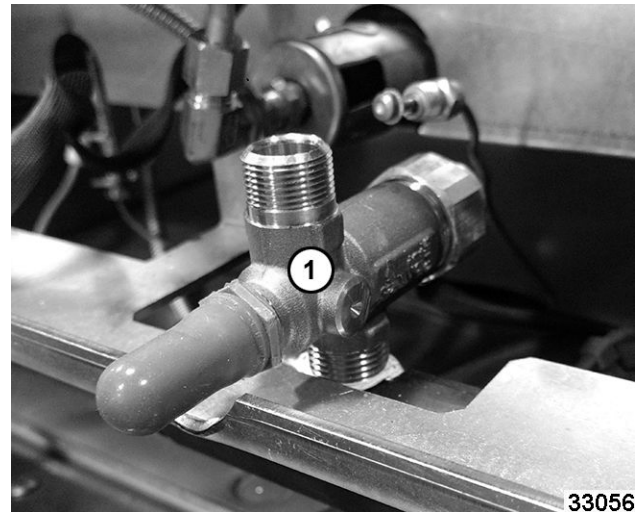

Fig. 69

6. Reverse procedure to install.

NOTE: Remove and reuse gray seal, unless also being replaced

⚠ WARNING

Clean pipe threads and apply thread sealant that is suitable for use with propane gases.

⚠ WARNING

All gas joints disturbed during servicing must be checked for leaks. Check with a soap and water solution (bubbles). Do not use an open flame.

7. Verify proper operation.



GRIDDLE PILOT ASSEMBLY AND THERMOCOUPLE (PREVIOUS PRODUCTION)

NOTE: The information in this section applies only to production built up to 5/12/19 for Manual Griddles models starting at Serial Number 481949646. Production built up to 2/14/19 for T-stat Griddles models Serial Number 481938361.



⚠ WARNING

Disconnect the electrical power to the machine and follow lockout / tagout procedures.



⚠ WARNING

Shut off the gas before servicing the unit and follow lockout / tagout procedures.

⚠ WARNING

All gas joints disturbed during servicing must be checked for leaks. Check with a soap and water solution (bubbles). Do not use an open flame.

1. Remove GRIDDLE CONTROL BRACKET (PREVIOUS PRODUCTION).
2. Remove screws (2) securing pilot assembly mounting bracket to griddle burner box.
 - A. If replacing thermocouple only, remove thermocouple from pilot assembly and gas safety valve. Continue to last step.
3. If replacing pilot assembly, remove pilot tubing and thermocouple from pilot assembly.

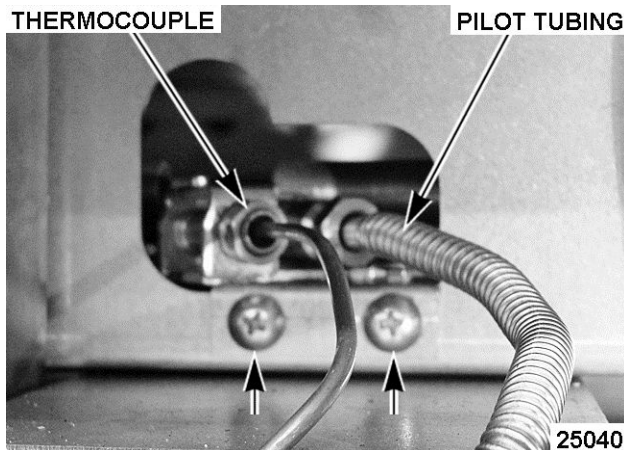

Fig. 70

4. Remove screws (2) securing pilot assembly to mounting bracket.
5. Reverse procedure to install and check for proper operation.

NOTICE

When installing, do not bend and kink the capillary tube or damage to the control may occur.

NOTE: When installing, ensure orifice hood is aligned and centered in the burner assembly opening.

GRIDDLE PILOT ASSEMBLY AND THERMOCOUPLE (CURRENT PRODUCTION)

NOTE: The information in this section applies only to current production starting on 5-13-19 for Manual Griddles models starting at Serial Number 481949647. Starting on 2-15-19 for T-stat Griddles models Serial Number 481938362.



⚠ WARNING

Disconnect the electrical power to the machine and follow lockout / tagout procedures.



⚠ WARNING

Shut off the gas before servicing the unit and follow lockout / tagout procedures.

1. Remove GRIDDLE THERMOSTAT VALVE (CURRENT PRODUCTION).
2. Remove screw between pilot burner gas supply line and thermocouple.



Fig. 71

3. Remove gas supply flex tube.

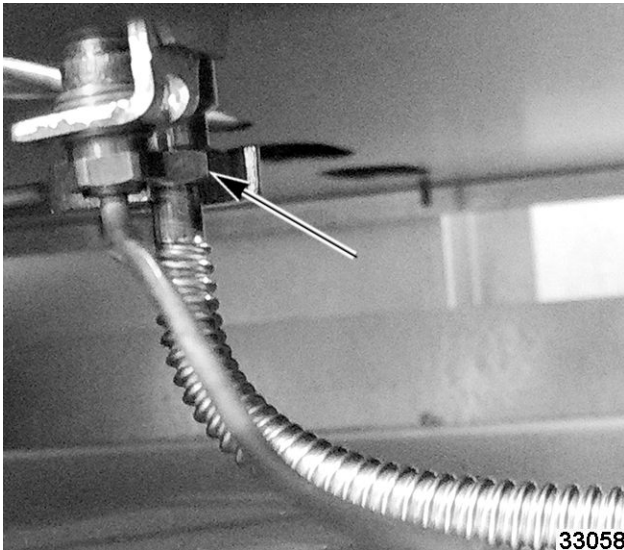

Fig. 72

- Reverse procedure to install.

⚠ WARNING

All gas joints disturbed during servicing must be checked for leaks. Check with a soap and water solution (bubbles). Do not use an open flame.

⚠ WARNING

Clean pipe threads and apply thread sealant that is suitable for use with propane gases.

- Verify proper operation.

GRIDDLE BURNER ORIFICE HOOD (PREVIOUS PRODUCTION)

NOTE: The information in this section applies only to production built up to 5/12/19 for Manual Griddles models starting at Serial Number 481949646. Production built up to 2/14/19 for T-stat Griddles models Serial Number 481938361.



⚠ WARNING

Shut off the gas before servicing the unit and follow lockout / tagout procedures.

⚠ WARNING

All gas joints disturbed during servicing must be checked for leaks. Check with a soap and water solution (bubbles). Do not use an open flame.

- Remove GRIDDLE CONTROL BRACKET (PREVIOUS PRODUCTION).
- Remove the orifice hood from fitting.

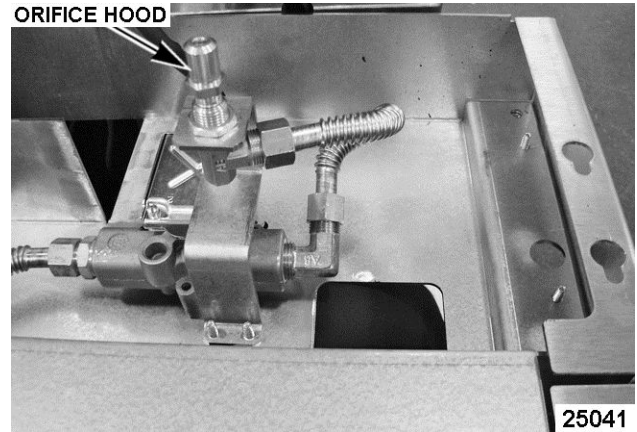

Fig. 73

- Reverse procedure to install and check for proper operation.

NOTE: When installing, ensure orifice hood is aligned and centered in the burner assembly opening.

GRIDDLE BURNER ORIFICE HOOD (CURRENT PRODUCTION)

NOTE: The information in this section applies only to current production starting on 5-13-19 for Manual Griddles models starting at Serial Number 481949647. Starting on 2-15-19 for T-stat Griddles models Serial Number 481938362.



⚠ WARNING

Disconnect the electrical power to the machine and follow lockout / tagout procedures.



⚠ WARNING

Shut off the gas before servicing the unit and follow lockout / tagout procedures.

- Remove GRIDDLE MANIFOLD COVER (CURRENT PRODUCTION).
- Remove control bracket GRIDDLE CONTROL BRACKET (THERMOSTACTICALLY CONTROLLED - CURRENT PRODUCTION).
- Remove nut (1, Fig. 74).



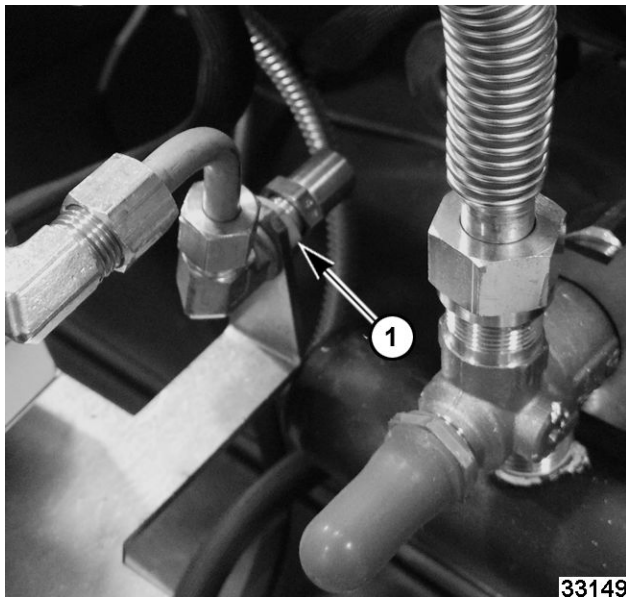

Fig. 74

4. Carefully pull forward for access and remove orifice.
5. Reverse procedure to install.
6. Verify proper operation.

CHARBROILER PILOT



WARNING

Shut off the gas before servicing the unit and follow lockout / tagout procedures.



WARNING

Disconnect the electrical power to the machine and follow lockout / tagout procedures.

1. Remove CHARBROILER BURNER to access pilot.
2. Remove crumb trays.

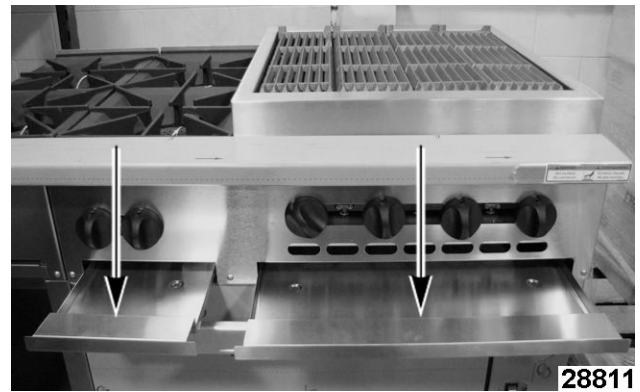

Fig. 75

3. Remove knobs from front of range.



Fig. 76

4. Remove manifold cover.

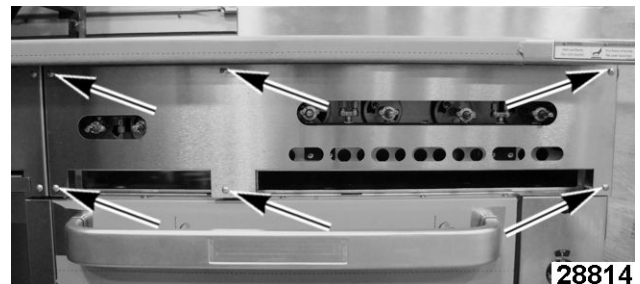

Fig. 77

5. Remove compression nut from pilot valve then remove pilot tube assembly from valve.

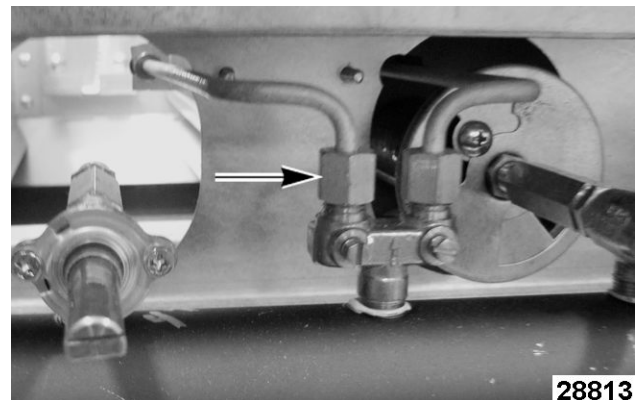

Fig. 78

6. Remove pilot tube assembly (1, Fig. 79) from pilot bracket (2, Fig. 79). Use pliers to separate as needed.

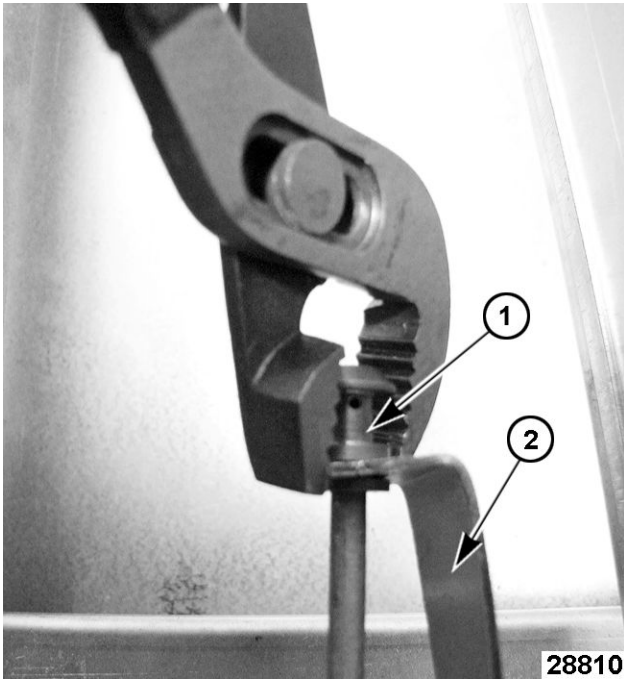

Fig. 79

7. Reverse procedure to install.

NOTE: If replacing pilot and tubing, ensure a compression nut and ferrule are installed on the end of tubing that connects to pilot valve.

CHARBROILER BURNER



⚠ WARNING

Shut off the gas before servicing the unit and follow lockout / tagout procedures.



⚠ WARNING

Disconnect the electrical power to the machine and follow lockout / tagout procedures.

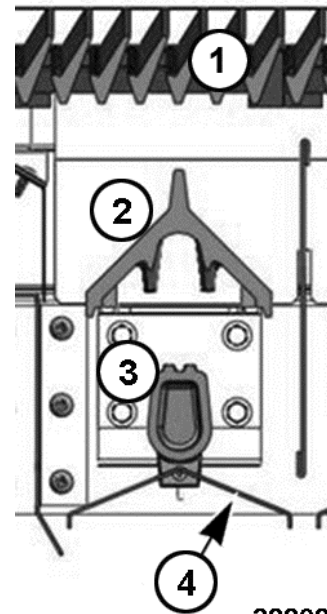

Fig. 80

Charbroiler Burner Components - Front View

- [1] Grate
- [2] Radiant
- [3] Burner
- [4] Deflector

1. Remove grate (1, Fig. 81) from charbroiler.

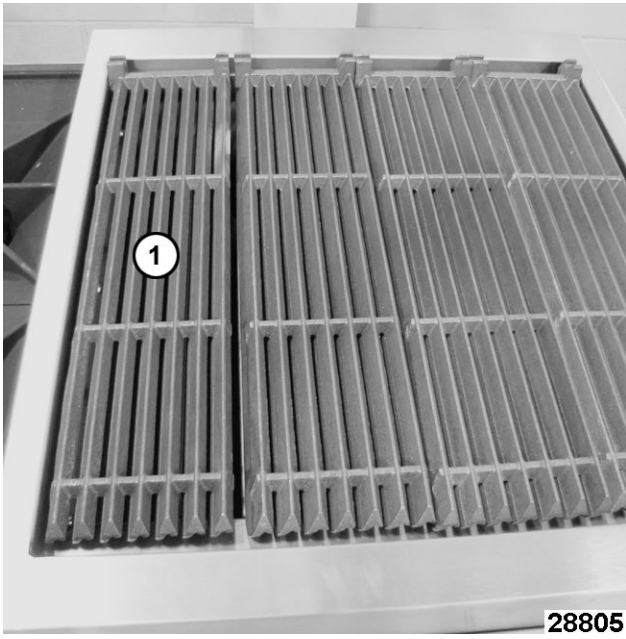

Fig. 81

2. Remove radiant (1, [Fig. 82](#)) to access burner.



Fig. 82

3. Remove burner (1, [Fig. 83](#)) and deflector (2, [Fig. 83](#)) by lifting at the rear of burner.

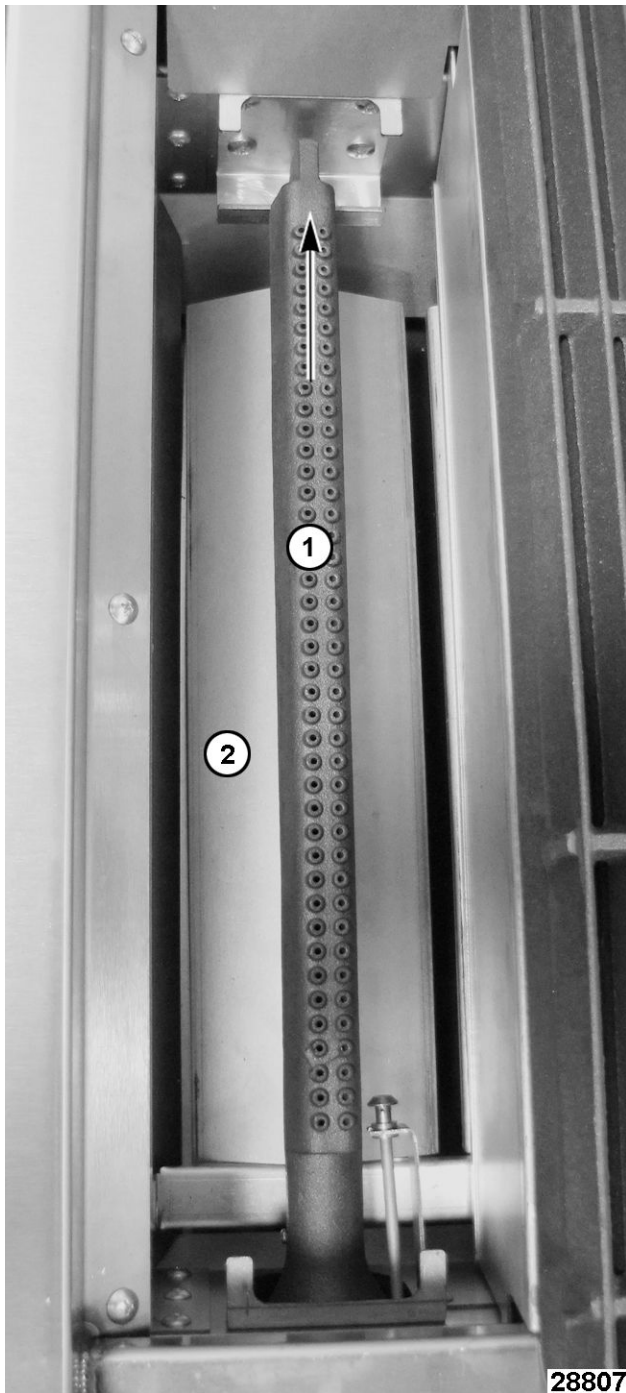

Fig. 83

4. Remove burner rod (1, [Fig. 84](#)) securing deflector (2, [Fig. 84](#)) to burner.

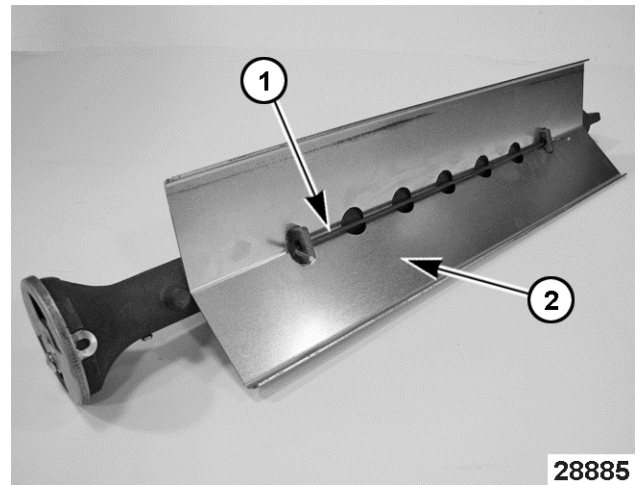

Fig. 84

5. To Install:
 - A. Install deflector onto replacement burner.
6. Verify BURNER AIR SHUTTER ADJUSTMENT.
7. Install radiant above the burner.
8. Install grate.
9. Check for proper operation.

SAFETY VALVE (FLAME SAFETY OPTION)



⚠ WARNING

Disconnect the electrical power to the machine and follow lockout / tagout procedures.



⚠ WARNING

Shut off the gas before servicing the unit and follow lockout / tagout procedures.

⚠ WARNING

All gas joints disturbed during servicing must be checked for leaks. Check with a soap and water solution (bubbles). Do not use an open flame.

1. Remove GRIDDLE MANIFOLD COVER (PREVIOUS PRODUCTION).
2. Disconnect pilot flex tube (1, [Fig. 85](#)) from gas manifold.

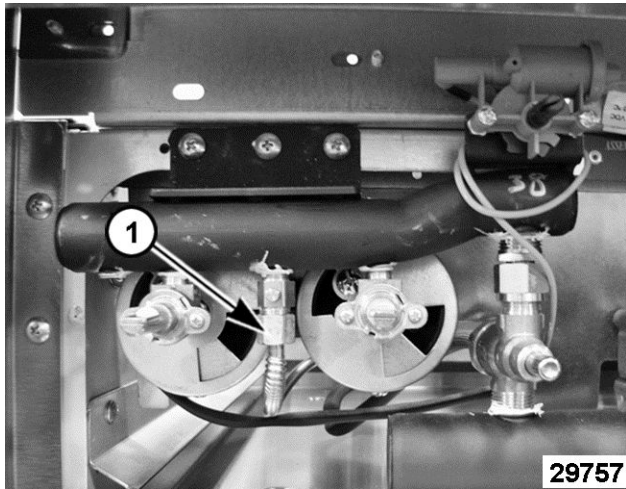

Fig. 85

3. Remove top burner grates (front and rear) from the range.
4. Lift grate support (1, Fig. 86) from range top.
5. Remove heat shield (2, Fig. 86).

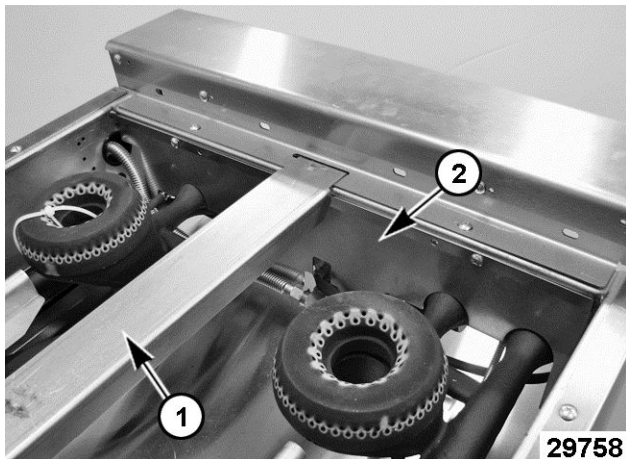

Fig. 86

6. Disconnect thermocouple (1, Fig. 87) from safety valve.

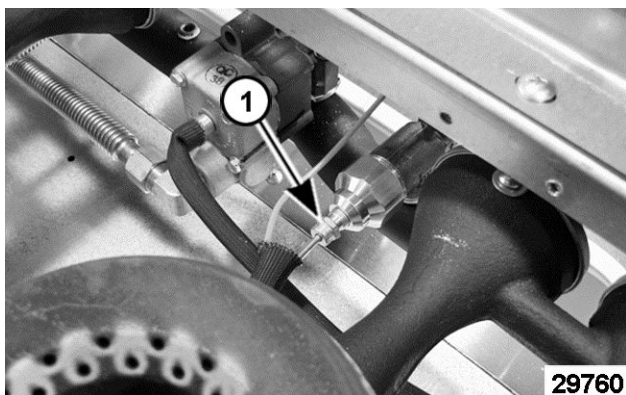

Fig. 87

7. Lift the top burner assembly at the rear and slowly pull away from manual valves. Lower the burner assembly and allow it to rest inside the burner box.
8. Remove gas manifold from frame (1, Fig. 88).
9. Disconnect safety valve compression nut (2, Fig. 88) from tube adapter on gas manifold then remove safety valve from gas manifold.

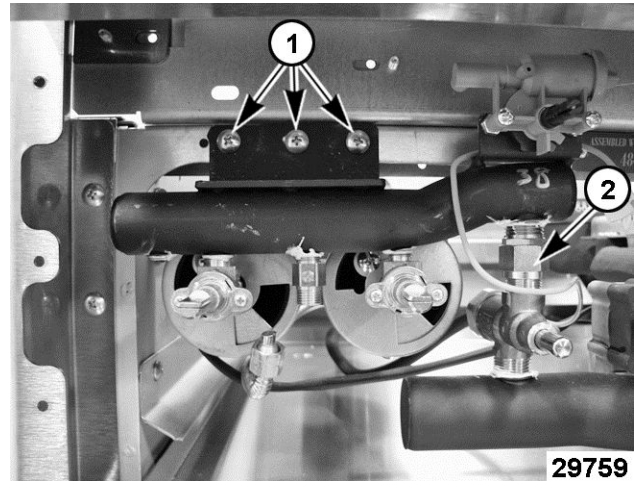

Fig. 88

⚠ WARNING

Clean pipe threads and apply thread sealant that is suitable for use with propane gases.

NOTE: See TOOLS for cleaning of pipe threads.

NOTICE

When installing, do not bend and kink the capillary tubes or damage to the controls may occur.

10. Reverse procedure to install and check for proper operation.

OVEN SAFETY VALVE (CURRENT PRODUCTION)

NOTE: The information in this section applies only to current production starting on 5-13-19 for Manual Griddles models starting at Serial Number 481949647. Starting on 2-15-19 for T-stat Griddles models Serial Number 481938362.





⚠ WARNING

Disconnect the electrical power to the machine and follow lockout / tagout procedures.



⚠ WARNING

Shut off the gas before servicing the unit and follow lockout / tagout procedures.

1. Loosen set screw in knob (1, Fig. 89) and remove.



Fig. 89

2. Remove access cover screw (Fig. 90).



Fig. 90

3. Lift cover up and off retainer screws (Fig. 91).

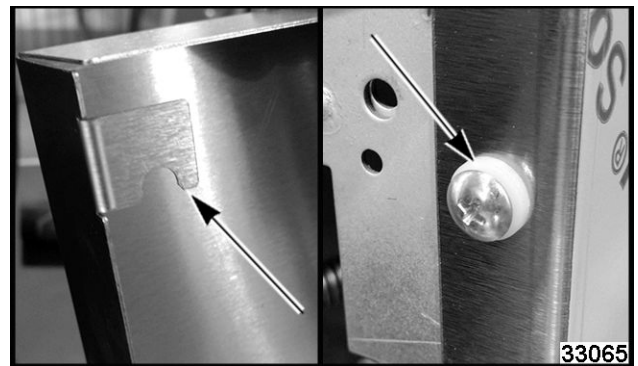

Fig. 91

4. Disconnect gas connections.
 - Main gas supply (1, Fig. 92).
 - Gas flex line (2, Fig. 92) out to burner.
 - Gas flex line (3, Fig. 92) out to pilot.

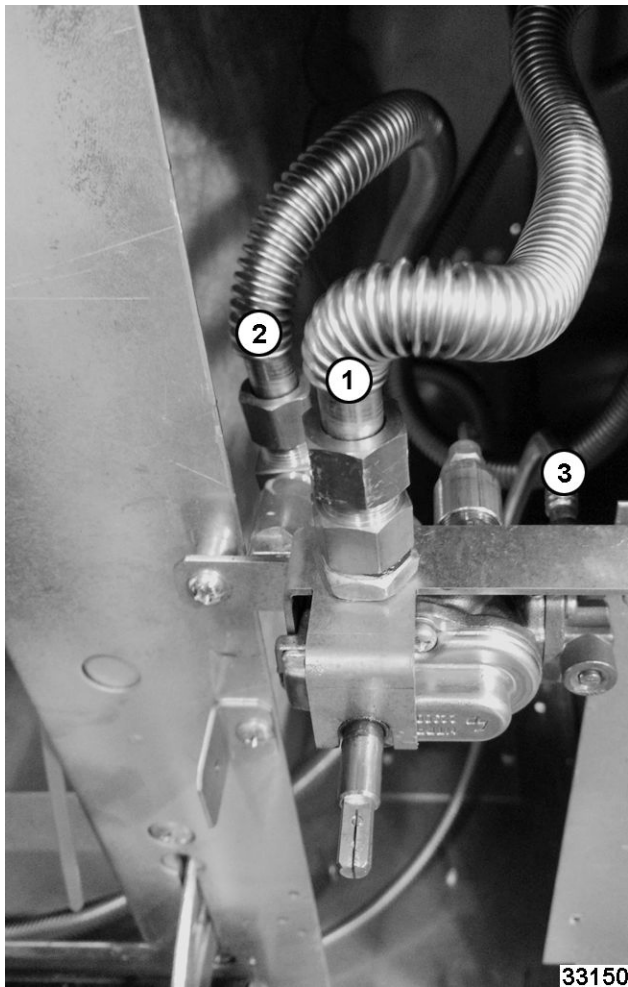

Fig. 92

5. Remove fitting (1, Fig. 93), retaining nut (2, Fig. 93) and pull assembly off bracket (3, Fig. 93)

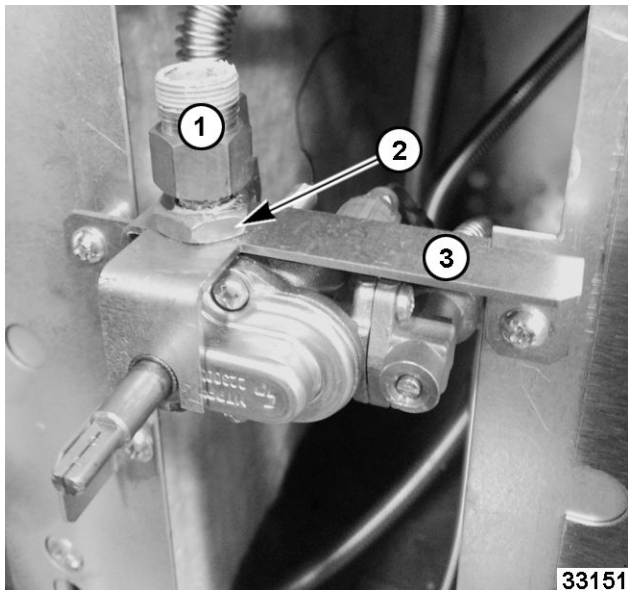

Fig. 93

6. Remove thermocouple (1, Fig. 94).

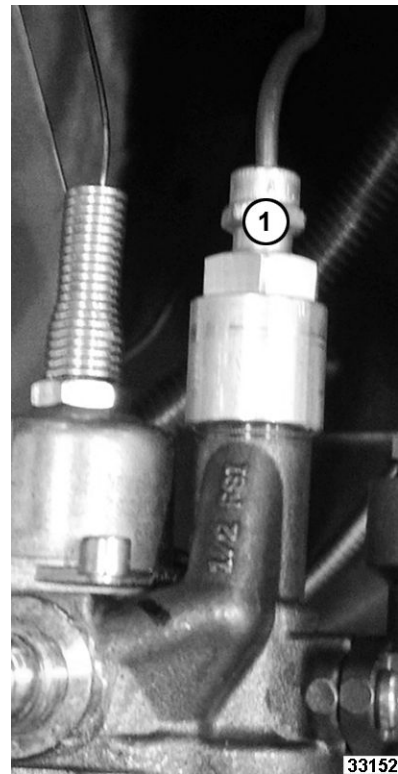

Fig. 94

7. Remove capillary from inside oven mounting bracket.

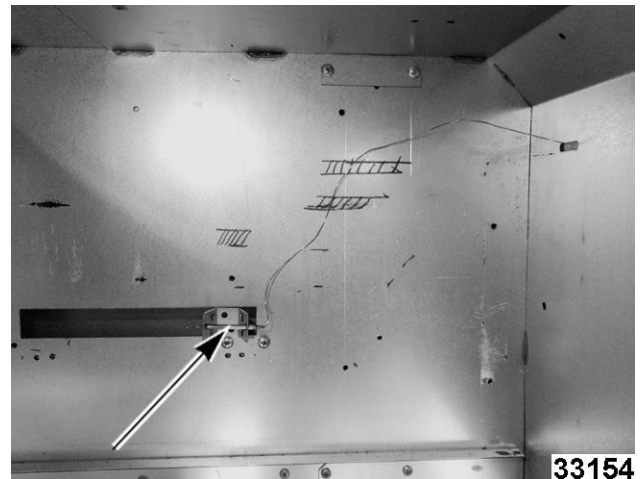

Fig. 95

NOTE: Removing bulb may be easier by removing bracket. Bracket must be pinched to relieve tension to remove bulb.

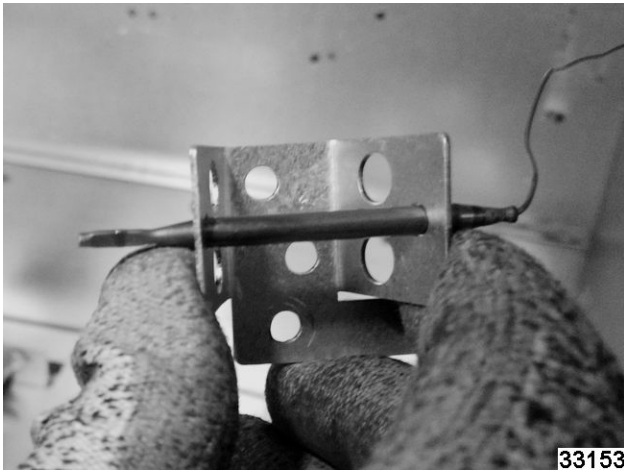

Fig. 96

8. Remove thermostat/pilot safety valve with capillary tube.
9. Reverse procedure to install.

⚠ WARNING

Clean pipe threads and apply thread sealant that is suitable for use with propane gases.

10. Verify proper operation.

ROTARY IGNITER (FLAME SAFETY OPTION)



⚠ WARNING

Disconnect the electrical power to the machine and follow lockout / tagout procedures.



⚠ WARNING

Shut off the gas before servicing the unit and follow lockout / tagout procedures.

1. Remove GRIDDLE MANIFOLD COVER (PREVIOUS PRODUCTION).
2. Disconnect igniter wires (1, Fig. 97) at the rear of rotary igniter (2, Fig. 97).
3. Remove screws and nuts (3, Fig. 97) securing rotary igniter (2, Fig. 97) to the mounting bracket on gas manifold then remove rotary igniter.
4. Remove screws and spacer nuts from rotary igniter and install them on the replacement rotary igniter.

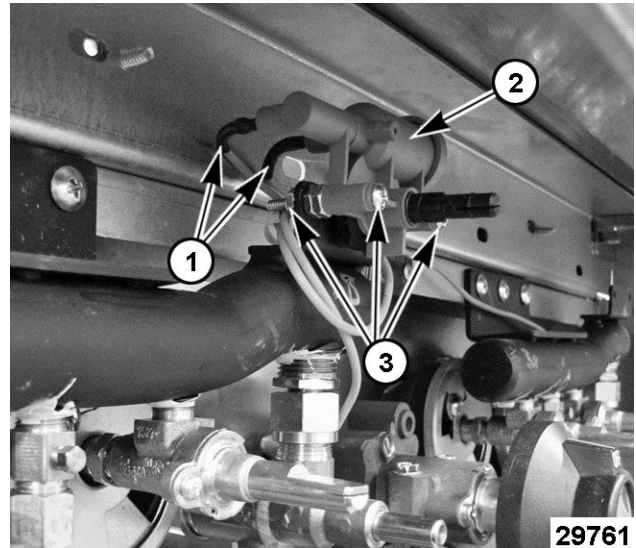

Fig. 97

5. Reverse procedure to install and check for proper operation.

TOP BURNER PILOT ASSEMBLY AND THERMOCOUPLE (FLAME SAFETY OPTION)



⚠ WARNING

Disconnect the electrical power to the machine and follow lockout / tagout procedures.



⚠ WARNING

Shut off the gas before servicing the unit and follow lockout / tagout procedures.

⚠ WARNING

All gas joints disturbed during servicing must be checked for leaks. Check with a soap and water solution (bubbles). Do not use an open flame.

1. Remove GRIDDLE MANIFOLD COVER (PREVIOUS PRODUCTION).
2. Disconnect pilot flex tube from gas manifold.



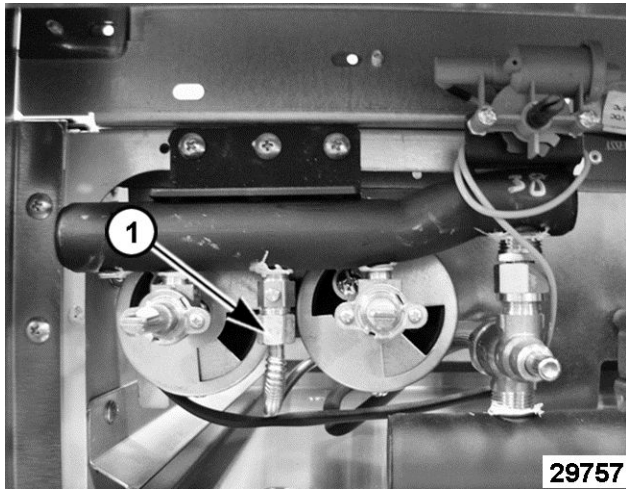

Fig. 98

3. Disconnect igniter wires (1, Fig. 99) from rotary igniter (2, Fig. 99).

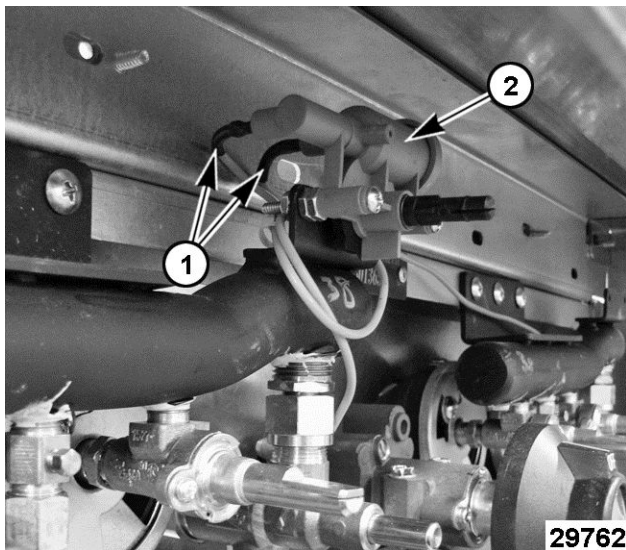

Fig. 99

4. Remove top burner grates (front and rear) from the range.
5. Lift grate support (1, Fig. 100) from range top.
6. Remove heat shield (2, Fig. 100).

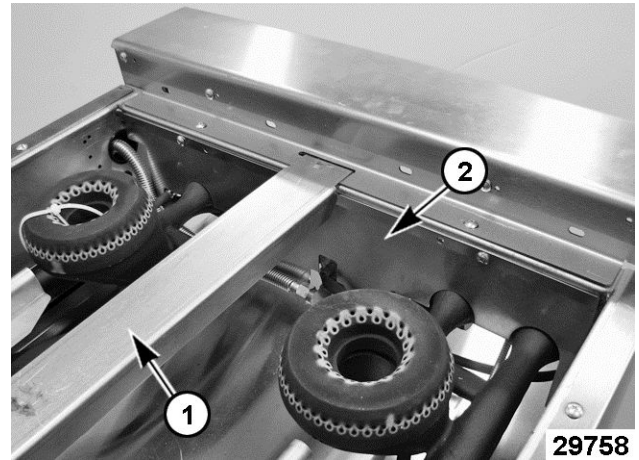

Fig. 100

7. Disconnect thermocouple (1, Fig. 101) from safety valve.

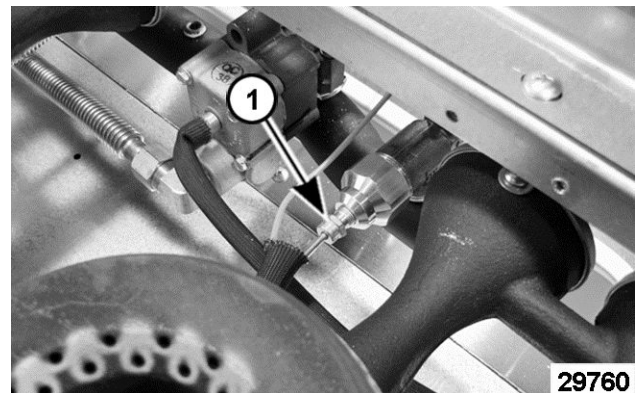

Fig. 101

8. Remove screws (1, Fig. 102) securing pilot assembly (2, Fig. 102) and flash tube (3, Fig. 102) to the burner assembly. Slide pilot assembly out from mounting slot in flash tube.

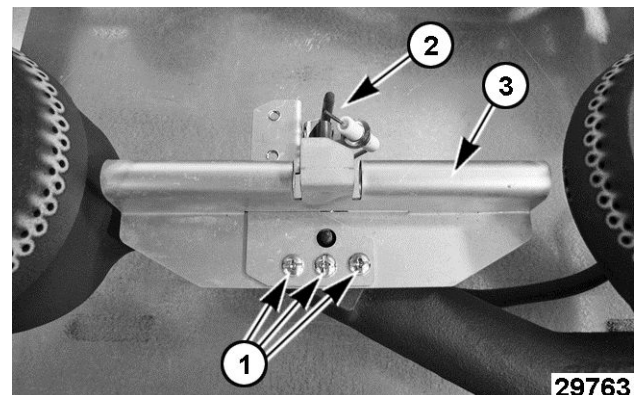

Fig. 102

NOTE: The pilot assembly picture above is shown with the pilot shield removed.

9. If replacing thermocouple only, remove thermocouple (1, Fig. 103) from pilot assembly. Continue to last step.

10. If replacing pilot assembly, remove pilot flex (2, Fig. 103) tube and thermocouple (1, Fig. 103).
 - A. Remove screw (3, Fig. 103) securing pilot assembly to mounting bracket.

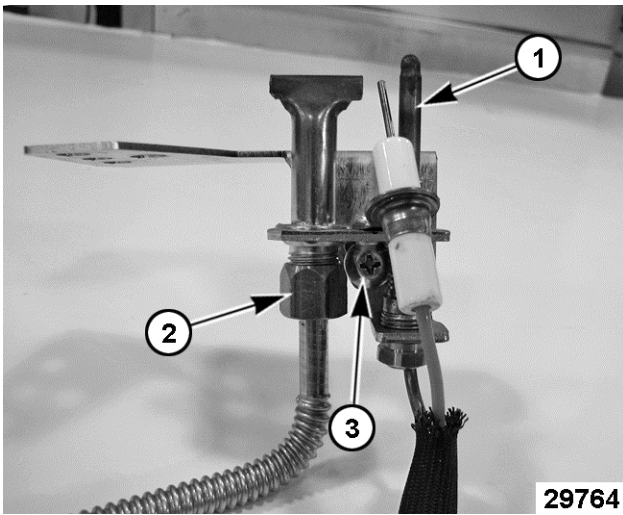

Fig. 103

11. Remove insulation sleeving from thermocouple tube and igniter wire. Retain for use on replacement part.
12. Reverse procedure to install and check for proper operation.

NOTICE

When installing, do not bend and kink the capillary tubes or damage to the controls may occur.

NOTE: When installing be sure to route thermocouple through the insulation sleeving. And, ensure the flash tube is aligned properly between the burner heads. Refer to TOP BURNER ASSEMBLY removal procedure.

DOOR STOP



WARNING

Disconnect the electrical power to the machine and follow lockout / tagout procedures.

1. Remove OVEN DOOR.
2. Tie string or flexible wire around pin or roller (1, Fig. 104).

NOTE: Holding onto string/wire while removing stop will secure it from failing down into oven cavity.

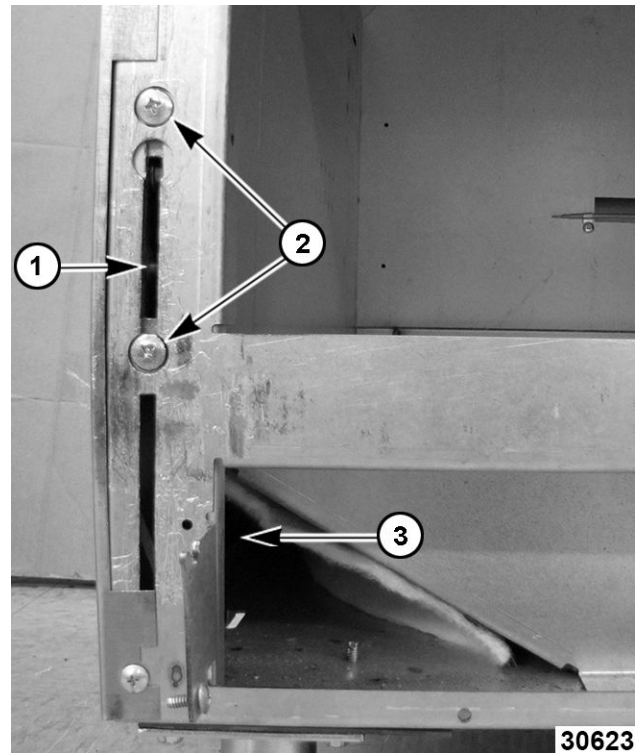

Fig. 104

3. Unscrew stop bracket from oven frame.
4. Slide stop bracket down cavity channel and out through opening (3, Fig. 104).
5. Tie string or flexible wire around pin or roller on new bracket (1, 2, Fig. 105) to assist installation up through cavity channel.



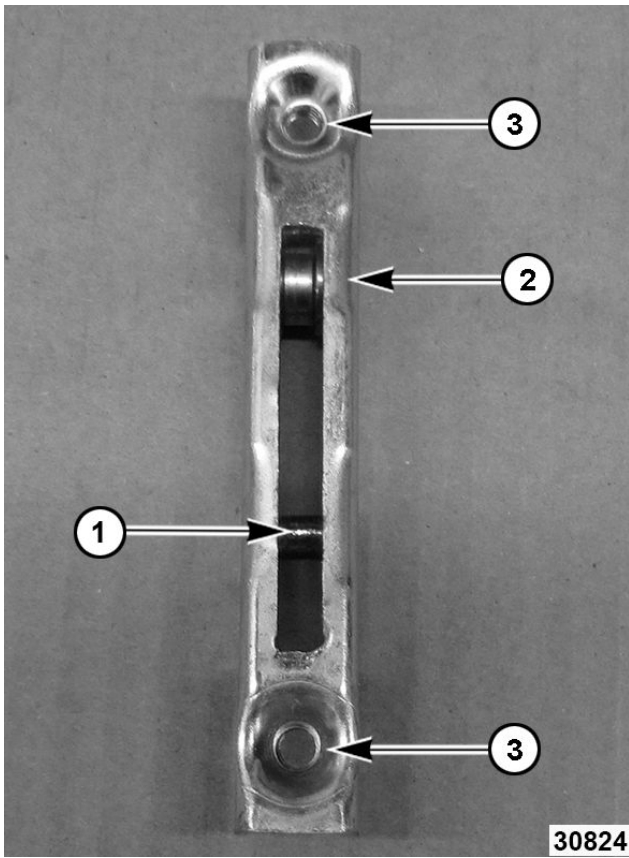

Fig. 105

6. Align oven frame and stop bracket mounting holes (2, Fig. 105) and install screws.
7. Install OVEN DOOR.
8. Verify door operation.

SERVICE PROCEDURES AND ADJUSTMENTS

PILOT FLAME HEIGHT

Oven Pilot Adjustment

1. Remove CONTROL PANEL (30" OVENS).
2. Lower the KICK PANEL (24" & 30" OVENS) to access gas safety valve on 24" standard ovens and to view pilot flame height on all ovens.
3. Remove pilot adjustment cover screw from gas safety valve.

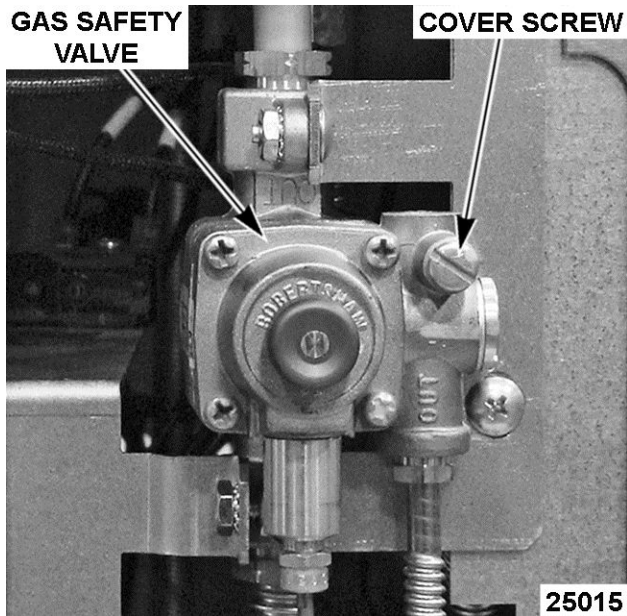

Gas Safety Valve on 30" Ovens Shown
(Convection & Standard)

4. Rotate pilot adjustment screw *clockwise* to decrease and *counterclockwise* to increase pilot flame height.
5. Pilot flame is in adjustment when it is approximately $\frac{1}{2}$ " tall and flame surrounds one third of the thermocouple down from the tip of the hot junction end.
6. Reverse procedure to install and check for proper operation.

NOTE: After adjustment, ensure cover screw is re-installed.

Top Burners Pilot Adjustment

To adjust the pilot flame height of the top burners, locate the pilot adjustment screws found on the front manifold pipe between the burner control knobs. It is not necessary to remove the gas manifold cover as adjustment access holes have been provided in the

panel. You may need to remove a knob depending on the orientation of the pilot adjustment screw.

1. Locate the pilot adjustment screw located behind the adjustment access hole in the panel.

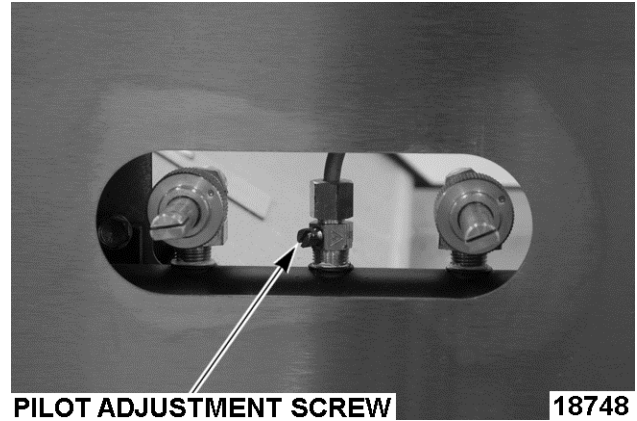

Fig. 107

2. Rotate the screw clockwise to decrease and counterclockwise to increase flame height.
3. Pilot is in adjustment when it will stay on continually and lights the burners without delayed ignition.
4. On range models with a thermocouple, the pilot burner flame should surround the thermocouple at the hot tip end and cover an area of at least $\frac{3}{8}$ " to $\frac{1}{2}$ " on the thermocouple hot tip end.

BURNER AIR SHUTTER ADJUSTMENT

The efficiency of the burner depends on a delicate balance between the air supply and volume of gas. Whenever this balance is disturbed, poor operating characteristics and excessive gas consumption may occur. An air shutter on the front of the burner controls the gas mixer balance. A yellow streaming flame on the burner is an indication of insufficient primary air.

To correct this condition, loosen the shutter screw and rotate the air shutter open until the flame begins to lift from the burner, then close the shutter slightly and tighten the shutter screw. A proper flame should be blue in color, well-defined and seated on the burner port. A white-blue flame is a result of excessive primary air.

NOTE: The factory default air shutter positions are half open natural; full open propane.

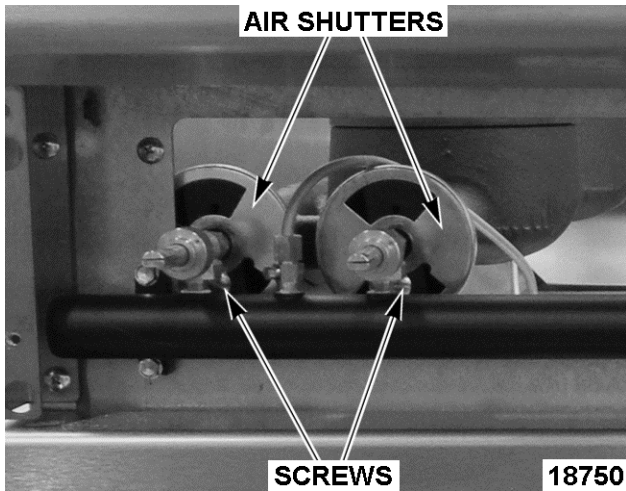

Top Burner Air Shutters

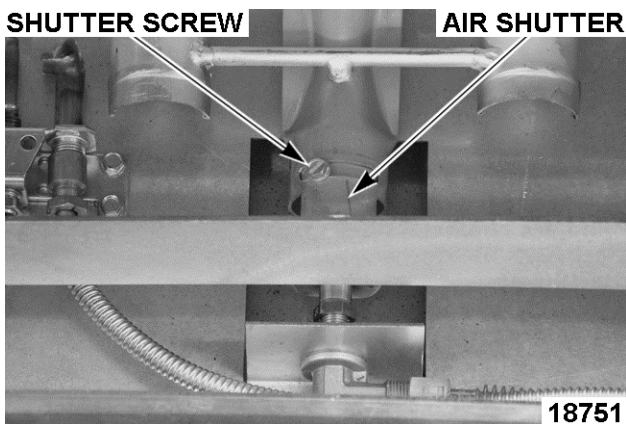

Oven Burner Air Shutter

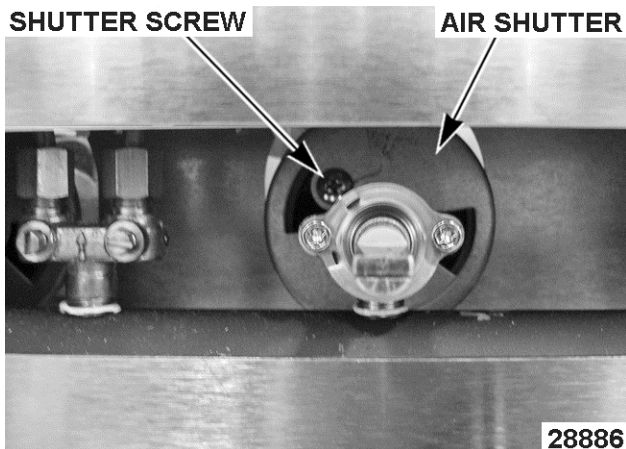

Charbroiler Burner Air Shutter

REGULATOR ADJUSTMENT

NOTE: Regulators come preset, but should be checked anytime one is installed. Before adjusting regulator, check incoming gas line pressure. Incoming pressure must be 6-14" W.C. for natural gas and 11-14" W.C. for propane gas. If incoming pressure is not correct, have the gas source checked and

adjusted as necessary. Make sure the regulator is mounted in the horizontal position with the arrow pointing in the direction of gas flow. Clean vent cap before adjusting. Fig. 111 shows gas flow direction and vent cap location.

See unit data plate, riveted inside the kick panel, for manifold pressure setting information. Fig. 112 shows manifold pressure tap location.

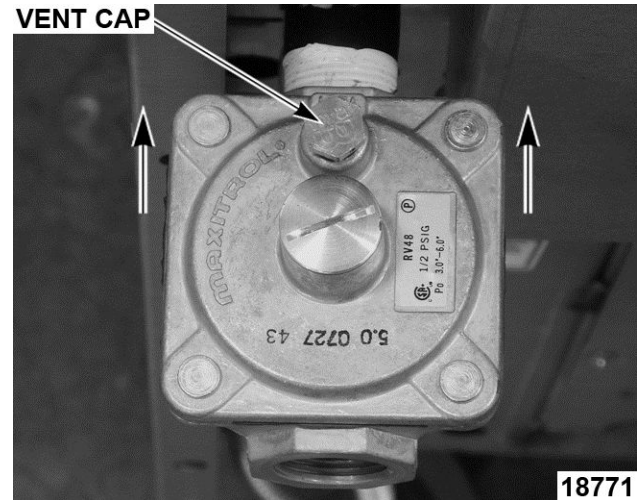

Fig. 111

1. Connect manometer to either of the pressure taps provided on the range gas piping between the burner control valve sets. If pressure taps are not available, install a pipe tee and hose barb assembly on the outlet of the regulator. See TOOLS.

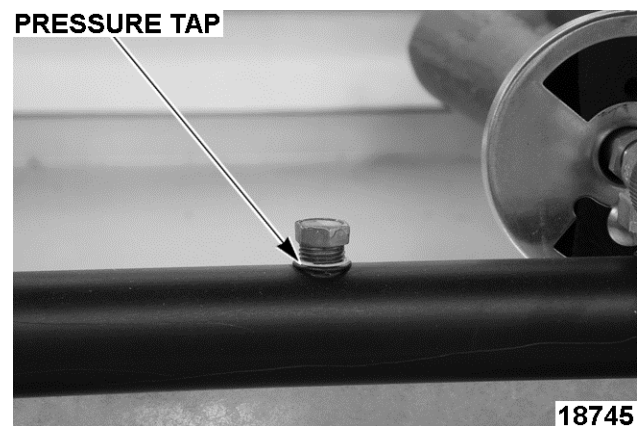

Fig. 112

2. Open the valves to turn on approximately half of the units burners to the full on position and check manometer reading. The reading should be 5" W.C. for natural gas and 10" W.C. for propane gas. Tolerance is ± 0.3 " W.C.
3. If manifold pressure is not correct, adjust the regulator as follows:
 - A. Remove the regulator closing nut.

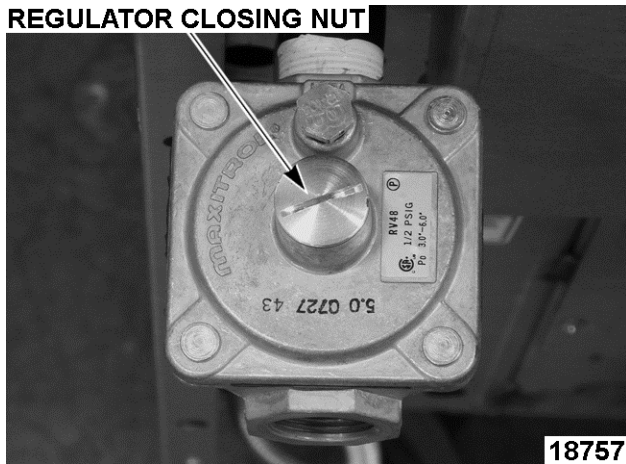

Fig. 113

- B. Insert a flat edge screwdriver into the top of regulator housing to reach the adjusting screw. While watching the manometer, turn the adjusting screw clockwise to increase pressure and counterclockwise to decrease pressure until the proper gas pressure is achieved. See data plate.
- C. Install the regulator closing nut.
- D. Remove manometer from pressure tap.
- E. Apply thread sealant to pressure tap plug and reinstall. Thread sealant must be insoluble in propane and natural gas.

BURNER NOZZLE CHECK

The burner nozzle is mounted between the oven gas supply tubing/mounting bracket and the u-burner assembly. If burner operation seems poor and other systems have been checked, access the burner for the range section being serviced and remove the burner nozzle.

- Check for blockage or damage.
- Verify gas orifice hood is correct for the altitude. See SPECIFICATIONS for Orifice Size Requirements.

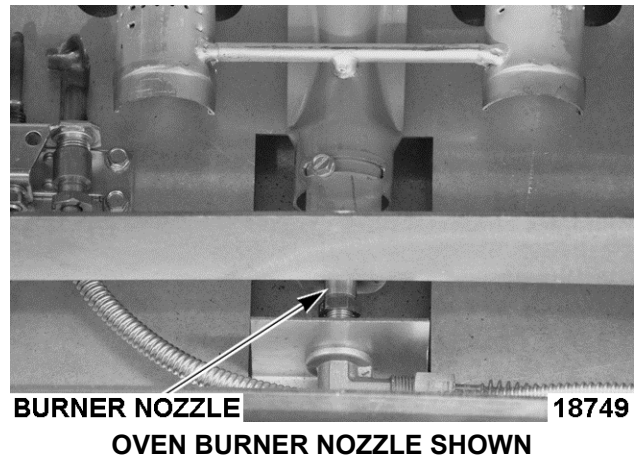

BURNER NOZZLE 18749
OVEN BURNER NOZZLE SHOWN

STANDARD OVEN THERMOSTAT BY-PASS FLAME ADJUSTMENT

NOTE: The bypass flame setting has a direct affect on calibration, and must be verified prior to checking or adjusting calibration of any "modulating thermostat". The by-pass flame can be viewed through the kick panel for adjustment.

NOTICE

All burners on the device must be on during by-pass flame adjustment.

1. Turn thermostat knob to 375°F.
2. Wait 15 minutes for oven to heat up.
3. Turn thermostat knob to lowest oven setting. **DO NOT TURN OFF.**
4. Observe burner flame. The flame should be approximately 1/8" and stable on each port as shown in Fig. 115.

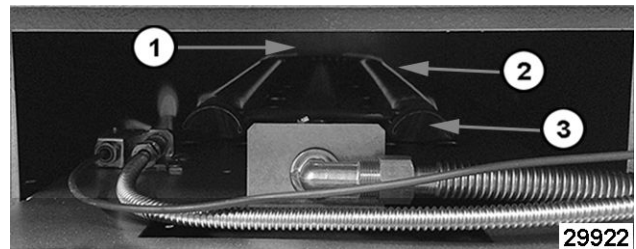

Fig. 115

By-Pass Flame shown in Fig. 115	
Item	Description
1	Gap in flame, or some flickering of the flame is acceptable, only in the U-shape bend of the burner.
2	By-Pass flame.

3	Oven burner.
---	--------------

5. Remove thermostat knob.
6. With a small flat edge screwdriver, turn by-pass flame adjustment screw Fig. 116 counterclockwise to increase by-pass flame or clockwise to decrease flame until both legs of burner have approximately 1/8" stable flame on each port. Ports should be set to just above "flickering".

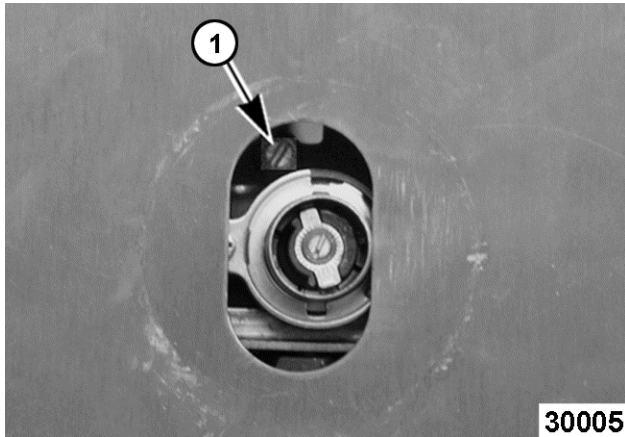

Fig. 116

7. Replace thermostat knob.
 - A. Turn knob to 400°F .
 - B. Verify increase in flame height on burner ports.
8. Turn knob back to lowest oven setting. Verify decrease in by-pass flame height on burner ports and that burner remains lit.
9. Verify STANDARD OVEN THERMOSTAT TEMPERATURE CALIBRATION.

STANDARD OVEN THERMOSTAT TEMPERATURE CALIBRATION

⚠ WARNING

Do not use bi-metal or mercury thermometers when testing food equipment or products. Chemicals within these instruments may be toxic if exposed to food.

1. Adjust by-pass flame. Refer to STANDARD OVEN THERMOSTAT BY-PASS FLAME ADJUSTMENT.

NOTE: Thermometer test instrument needed for calibration.

2. Place thermocouple of test instrument in geometric center of oven using oven rack.

3. Light burner by turning thermostat to 350°F (122° C).
4. Allow unit to heat until burner flame is observed going into bypass.
5. Wait approximately 10 minutes until burner flame has cycled on and into bypass.
6. Compare test instrument reading with dial setting when burner goes into bypass.
 - Reading within +/- 25°F (13.9°C) of dial setting is correct calibration.
 - Reading not within tolerance, RECALIBRATE.

Recalibrate

- A. Pull dial straight off dial shaft.
- B. Place screwdriver through dial shaft to push metal dial insert out of dial.
- C. Replace dial back onto unit.
- D. Hold thermostat dial in place.
- E. Insert screwdriver into dial shaft to engage calibration stem adjustment screw and push inward.

NOTICE

DO NOT TURN SCREW, this will damage thermostat.

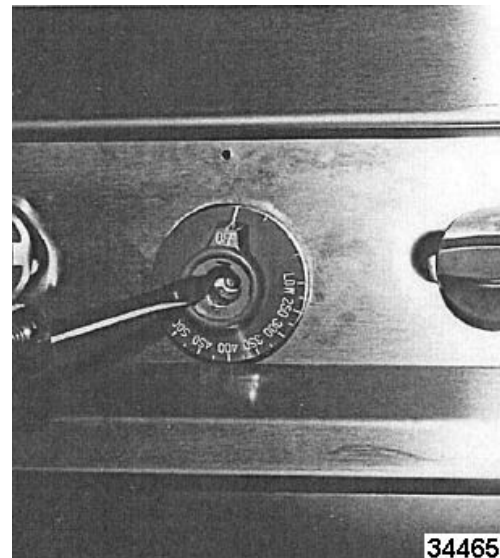

Fig. 117

- F. Hold calibration stem screw in place and turn thermostat dial until it is set on actual temperature shown on test device.
- G. Release calibration screw and reinstall dial metal insert.



- H. Set dial to 450° (232.2°C) and verify temperature in oven to dial setting.

NOTICE

If calibration is not within +/- 25°F (13.9°C) of dial setting, replace thermostat.

**CONVECTION OVEN
THERMOSTAT VALVE
CALIBRATION**

Operation

The thermostat valve is self-regulating and the thermostat is internally connected to the valve. When thermostat dial is set to 350°F and the oven is below setpoint, the valve opens to allow gas flow and burner lights. As the oven temperature rises, the pressure from the sensor bulb in the oven increases. Fluid in the capillary tube expands with the temperature increase and presses against a diaphragm in the thermostat. When the oven temperature reaches setpoint, the internal valve closes to stop gas flow to burner.

When the oven temperature decreases below setpoint, the pressure is reduced in the capillary which reduces the force on the diaphragm allowing the valve to open again.

Calibration

1. Place a thermocouple temperature probe in center of oven to verify actual temperatures throughout adjustment. See TOOLS for thermocouple type.
2. Turn power switch on.
3. Turn thermostat knob to 350°F and allow oven to cycle 3 complete times.
 - A. If the customer has a preferred temperature setting that they always operate the oven at such as 325°, 375° or 400°, you may calibrate to that temperature instead.

NOTE: Most calibrations are made at 350°F. Thermostat tolerance will increase at higher temperature settings.

4. Observe burner flame. Note temperature tester reading when burner turns ON and OFF.
5. Add these two temperatures together, then divide the sum by 2 to obtain an average temperature. If the average temperature is more than ±25°F from knob setting, calibrate as follows:

- A. Pull off knob. **Do not rotate knob during removal.**

NOTICE

Do not turn the adjustment screw more than 3/8 turn or damage to the thermostat may occur.

- B. While holding outer shaft in place, turn inner screw using a small flat edge screwdriver 1/8 turn clockwise to decrease and counterclockwise to increase. 1/4 turn = 35°F. See Fig. 118 below.
- C. Verify temperature at 350°F (or customers preferred setting). Allow oven to cycle 3 times.

NOTE: You must allow the oven to cycle 3 times to stabilize oven temperature or the calibration adjustment may be invalid. **DO NOT TURN KNOB.**

- D. Take a temperature reading. If temperature is within acceptable limits, continue to next step. If temperature is not within ±25°F then re-adjust as outlined in this procedure. If 3 consecutive adjustments do not produce acceptable results, replace thermostat and verify calibration.
- E. Apply a small amount of a non permanent type sealer (preferably fast drying) such as nail polish or equivalent around the inner screw head to prevent movement during outer shaft rotation. Allow sufficient time for the applied sealer to dry then install knob. See TOOLS.
- F. If calibrating at 350°F, verify temperature at 400°F. If calibrating at a customer preferred temperature setting, select one temperature setting above the customer preferred setting. If the customers temperature setting is 450°F, then calibrate at that temp only. Allow oven to cycle 3 times at the temperature setting. If actual oven temperature is not within ±25°F of the setting, replace thermostat and verify calibration.



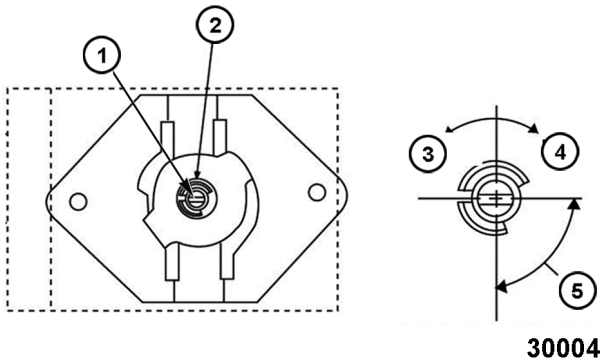

Fig. 118

Front of Thermostat Shown in Fig. 118	
Item	Description
1	Inner screw for temperature adjustment .
2	Outer Shaft.
3	Direction to <i>increase</i> temperature.
4	Direction to <i>decrease</i> temperature.
5	1/4 turn equals 35 °F.

GRIDDLE THERMOSTAT VALVE CALIBRATION

Operation

The thermostat valve is self-regulating and the thermostat is internally connected to the valve. When thermostat dial is set to 350°F and the griddle is below setpoint, the valve opens to allow gas flow and burner lights. As the griddle temperature rises, the pressure from the sensor bulb secured to the bottom of the griddle plate increases. Fluid in the capillary tube expands with the temperature increase and presses against a diaphragm in the thermostat. When the griddle temperature reaches setpoint, the internal valve closes to stop gas flow to burner.

When the griddle temperature decreases below setpoint, the pressure is reduced in the capillary which reduces the force on the diaphragm allowing the valve to open again.

Calibration

- Clean temperature test area on griddle zone surface. Apply a small amount of clean cooking oil to the test area to ensure good surface probe contact.
- Place a thermocouple surface probe in center of griddle zone to verify actual temperatures throughout adjustment. See TOOLS for thermocouple type. See table for proper testing locations according to griddle size.

NOTE: This procedure will need to be performed for each testing location on all griddle zones.

Griddle Size	Distance(s) From Left Edge of Griddle
12"	6"
24"	6", 18"
36"	6", 18", 30"

NOTE: All readings taken 12" from front of griddle.

- Turn thermostat knob to 350°F and allow griddle to cycle 3 complete times.
 - If the customer has a preferred temperature setting that they always operate the oven at such as 325°, 375° or 400°, you may calibrate to that temperature instead.
- NOTE:** Most calibrations are made at 350°F. Thermostat tolerance will increase at higher temperature settings.
- Observe burner flame. Note temperature tester reading when burner turns ON and OFF.
 - Add these two temperatures together, then divide the sum by 2 to obtain an average temperature. If the average temperature is more than ±25° from knob setting, calibrate as follows:
 - Pull off knob. **Do not rotate knob during removal.**

NOTICE

Do not turn the adjustment screw more than 3/8 turn or damage to the thermostat may occur.

- While holding outer shaft in place, turn inner screw using a small flat edge screwdriver 1/8 turn clockwise to decrease and counterclockwise to increase. 1/4 turn = 35°F. See Fig. 118 under CONVECTION OVEN THERMOSTAT-COMBO VALVE CALIBRATION.
- Verify temperature setting at 350°F (or customers preferred setting). Allow griddle to cycle 3 times.

NOTE: You must allow the griddle to cycle 3 times to stabilize oven temperature or the calibration adjustment may be invalid. **DO NOT TURN KNOB.**

- Take a temperature reading. If temperature is within acceptable limits, continue to next step. If temperature is not within ±25°F then readjust as outlined in this procedure. If 3 consecutive adjustments do not produce acceptable results, replace thermostat and verify calibration.

- E. Apply a small amount of a non permanent type sealer (preferably fast drying) such as nail polish or equivalent around the inner screw head to prevent movement during outer shaft rotation. Allow sufficient time for the applied sealer to dry then install knob. See TOOLS.
- F. If calibrating at 350°F, verify temperature at 400°F. If calibrating at a customer preferred temperature setting, select one temperature setting above the customer preferred setting. If the customers temperature setting is 450°F, then calibrate at that temp only. Allow oven to cycle 3 times at the temperature setting. If actual oven temperature is not within ±25°F of the setting, replace thermostat and verify calibration.

THERMOCOUPLE TEST

Operation

The thermocouple supplies a DC millivolt signal (MV) to the gas safety valve when heated by the pilot flame. The gas safety valve will shut off gas flow to the pilot and main burner in case of a pilot outage. When energized by the thermocouple voltage, the gas safety valve is held open to permit gas flow to the pilot and provide gas for the burner when the thermostat calls for heat. The pilot flame height is controlled by an adjustable needle valve located under a small cover screw on the gas safety valve.

Pilot Checks

If experiencing pilot outages, perform the following:

Visually check pilot flame for the proper contact on thermocouple and adjust as outlined under PILOT FLAME HEIGHT. If adjustment does not result in a pilot flame of proper height, then gas might not be flowing properly to the pilot.

Check for:

- A plugged pilot orifice.
- Kinked or plugged pilot gas tubing.
- Low gas supply pressure.

Thermocouple Checks

NOTE: Tubing connection from the thermocouple tip to gas safety valve is an electrical connection and must be clean and dry. Do not use any sealing compound on the threads of thermocouple nut.

NOTICE

Do not overtighten the thermocouple nut or the insulator could be crushed, shorting the thermocouple. Finger tighten the nut plus 1/4 turn with a wrench only.

If pilot flame is correct and there are no excessive air drafts in the room, then problem is either the thermocouple output voltage or the gas safety valve.

Visually check the thermocouple tip (hot end) and tube lead for:

- Loose thermocouple connection (electrical) at the safety valve.
- Corrosion or debris on the threaded connector or thermocouple tip causing a poor electrical connection.
- Kinks or pinches that might cause a short between the tube and the wire inside.

If thermocouple is loose, tighten mounting nut as described above in NOTICE. If thermocouple connection shows signs of corrosion or debris that cannot be cleaned; or damage as described, replace it and check pilot operation as outlined under PILOT FLAME HEIGHT.

Thermocouple Test

Check the thermocouple output voltage (DC millivolts) with a VOM as outlined in the steps below.

- If thermocouple adaptor (see TOOLS) is available, check *closed* circuit voltage as outlined in the test procedure.
 - If thermocouple adaptor is not available, check *open* circuit voltage as outlined in the test procedure.
 - If a VOM is not available, replace the thermocouple with a new one as outlined under the appropriate procedure below and check operation.
 - STANDARD OVEN PILOT ASSEMBLY AND THERMOCOUPLE.
 - CONVECTION OVEN PILOT ASSEMBLY AND THERMOCOUPLE.
 - GRIDDLE PILOT ASSEMBLY AND THERMOCOUPLE (PREVIOUS PRODUCTION)
 - SAFETY VALVE (FLAME SAFETY OPTION).
1. Disconnect thermocouple from gas safety valve.
 2. Select the test to perform.

3. **Closed Circuit.**
 - A. Install thermocouple adaptor at the threaded connection on gas safety valve.
 - B. Install thermocouple to the adaptor. Tighten mounting nut as described above in NOTICE.
 - C. Light the pilot. Allow pilot to heat thermocouple for one to two minutes.
 - D. Connect one meter lead to the adaptor test point and the other meter lead to the tube. Compare reading to the value listed in the table below.
4. **Open Circuit.**
 - A. Connect one meter lead to the tip of the threaded end and the other meter lead to the tube. Compare reading to the values listed in the table below.
 - B. Light the pilot and continue to hold down the pilot gas button on the safety valve during this test. Allow pilot to heat thermocouple for one to two minutes.
 - C. Compare reading to the value listed in the table below.

THERMOCOUPLE MV READINGS		
	Closed Circuit	Open Circuit
Range	8 to 25 MV	25 to 35 MV

5. If readings are less than the minimum stated above, replace the thermocouple as outlined under the appropriate procedure below and check for proper operation.

If a VOM is not available, replace the thermocouple with a new one as outlined under the appropriate procedure below and check operation.

- STANDARD OVEN PILOT ASSEMBLY AND THERMOCOUPLE.
- CONVECTION OVEN PILOT ASSEMBLY AND THERMOCOUPLE.
- GRIDDLE PILOT ASSEMBLY AND THERMOCOUPLE (PREVIOUS PRODUCTION).
- SAFETY VALVE (FLAME SAFETY OPTION).

6. If pilot is still not functioning properly after replacing thermocouple, then a problem exists in the gas safety valve. Install a replacement GAS SAFETY VALVE (STANDARD AND CONVECTION OVENS) or SAFETY VALVE (FLAME SAFETY OPTION).
7. Check for proper operation.

CHARBROILER PILOT ADJUSTMENT

Pilot Adjustment

- Turn pilot adjustment screws clockwise to decrease the flame.
- Turn pilot adjustment screws counter-clockwise to increase the flame.
- Pilot is in adjustment when it will stay on continually and lights the burner without delayed ignition.

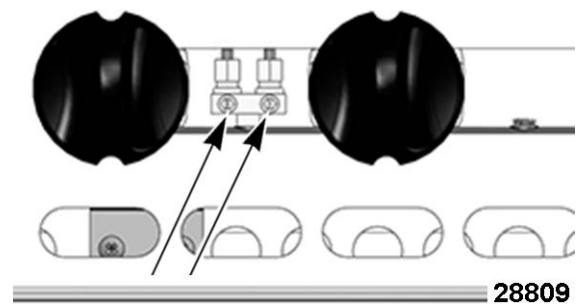

Fig. 119

ELECTRICAL OPERATION

COMPONENT FUNCTION

Power Cord	Connects range to power source.
On/Off Switch	Provides power for the convection oven motor and solenoid valve.
Solenoid Valve	Allows gas flow to the convection oven burner assembly when solenoid is energized by the door switch (normally closed valve).
Door Switch	Removes power from convection motor and solenoid valve when oven door is open (N.O. - held closed).
Convection Oven Motor (Single Phase)	Circulates heated air inside the oven. The motor electrical power is routed through door switch.
Junction Box	Connection point for electrical wires.
Safety Valve	Monitors standing pilot. All ovens, thermostatic griddles, and select open top burner devices with Flame Safety option feature a standing pilot that is monitored by a thermocouple and pilot safety valve. If the pilot goes out, the safety valve will shut-off the gas supply to the pilot and main burners. Flame safety option only.
Pilot Assembly	Provides flame to light burner.
Thermocouple	On models with a safety valve, provides milli-voltage signal to safety valve when heated by pilot flame.

COMPONENT LOCATION

FLAME SAFETY OPTION



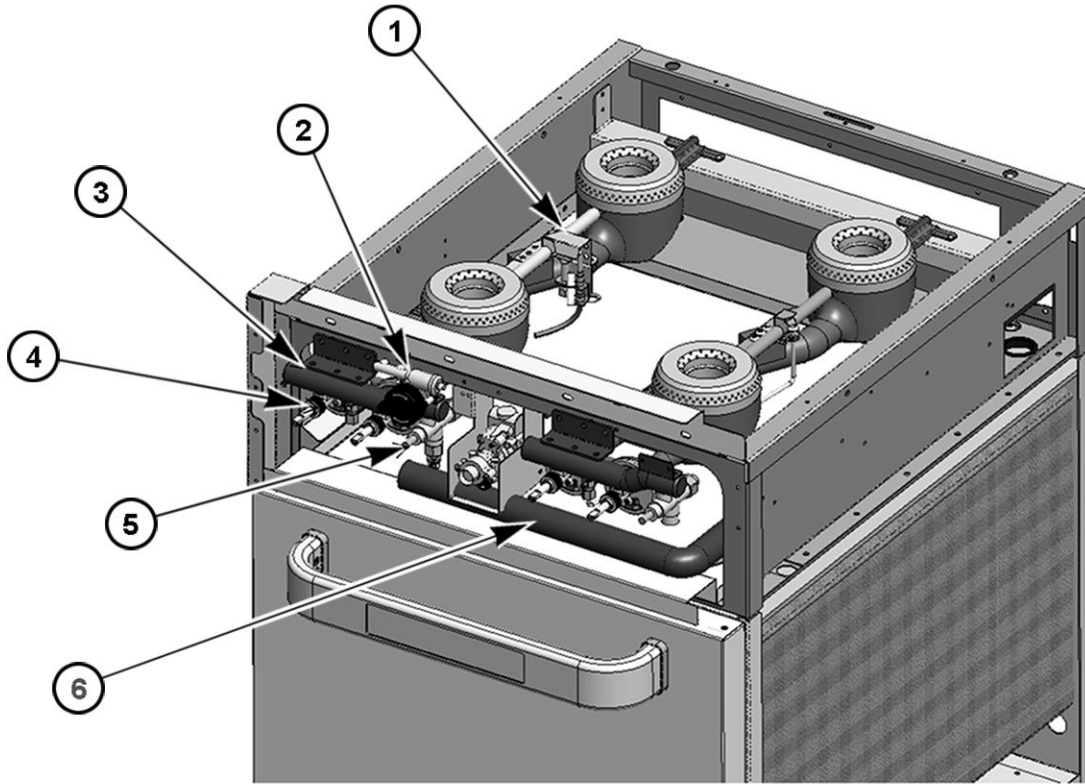

29796

Fig. 120

Item No.	Description
1	Pilot Assembly and thermocouple.
2	Rotary Igniter (Piezo type)
3	12" Manifold Sections
4	1/4 Turn Manual Valves
5	Safety Valve (1 per each 12" Manifold)
6	Manifold

SEQUENCE OF OPERATION - CONVECTION OVEN

Refer to AI3549 SCHEMATIC DIAGRAM - CONVECTION OVENS.

Oven temperature is below set point of control.

Convection Oven

1. Conditions.
 - A. 120VAC to oven controls and is properly grounded.
 - B. Power switch off.
 - C. Door switch held-closed (oven door closed).
 - D. Pilot lit.
 - E. Thermostat valve is off.
 - F. Oven at room temperature.
2. Turn power switch on.
 - A. Solenoid is energized allowing gas flow to thermostat valve.
 - B. Power to oven motor (blower circulates air inside cavity).
3. Set thermostat knob to 350°F.
 - A. Thermostat valve calls for heat and opens internal valve to allow gas flow to burner.
 - B. Pilot lights the burner and heating begins.

4. Oven reaches setpoint temperature. Thermostat valve closes internal valve to stop gas flow to burner.
5. Door switch opened (oven door open).
 - A. Power is removed from oven motor.
6. Oven door closed. Door switch contacts close and oven motor resumes operation.
7. Thermostat valve cycles the burner as required to maintain setpoint temperature until thermostat knob is turned to off; or power switch off.

SCHEMATIC DIAGRAM - CONVECTION OVENS

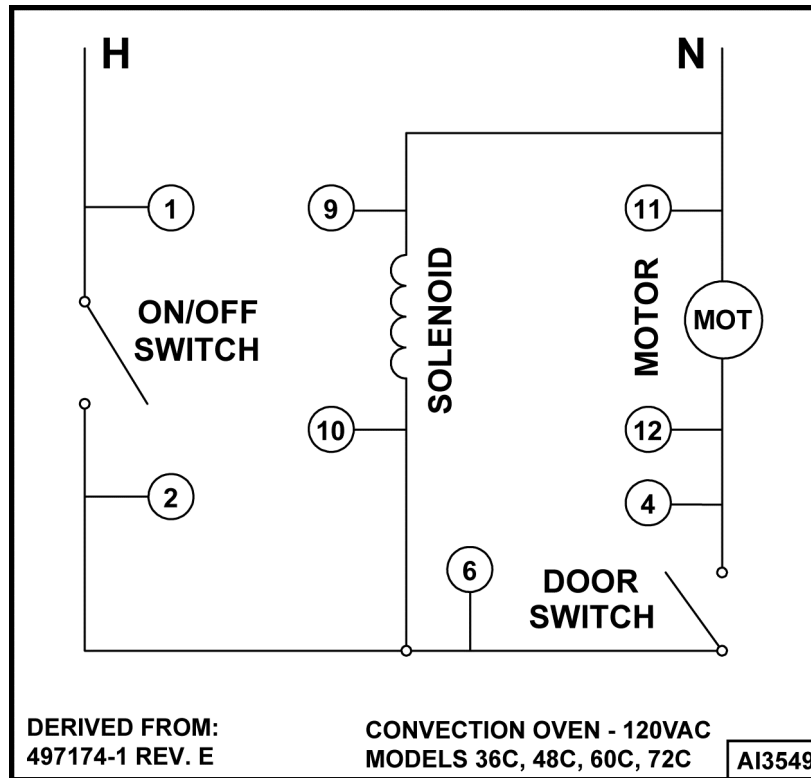

Fig. 121



WIRING DIAGRAM - CONVECTION OVENS

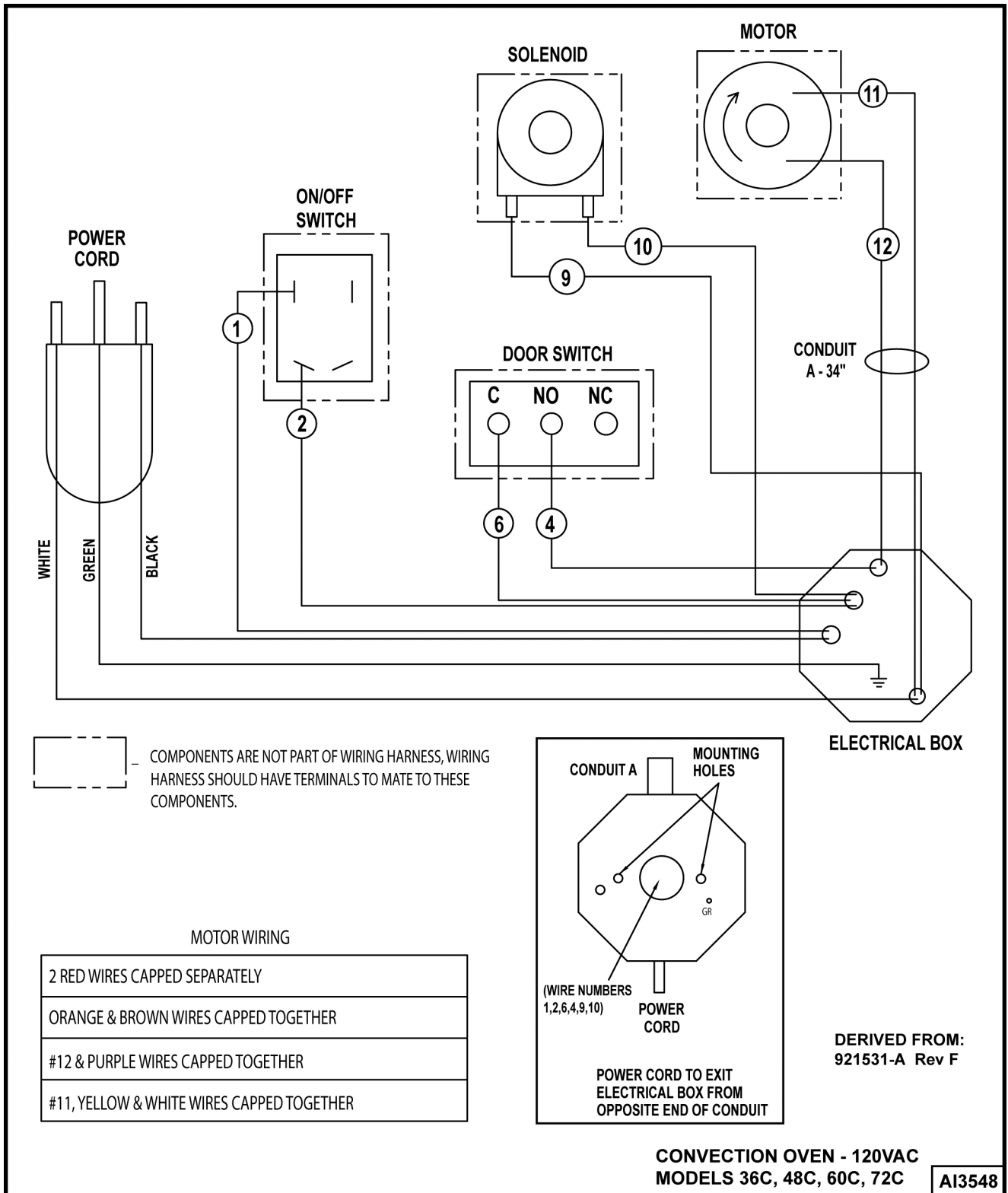

Fig. 122



TROUBLESHOOTING

TROUBLESHOOTING

GENERAL	
SYMPTOM	POSSIBLE CAUSE
Pilot does not remain lit.	<ol style="list-style-type: none"> 1. Incorrect gas pressure. 2. Pilot burner not adjusted properly. 3. Pilot burner blocked. 4. Thermocouple not positioned correctly or malfunctioning. 5. Gas safety valve malfunction. 6. Incorrect oven pilot orifice. 7. Ventilation issue in room (drafts blowing out pilot).
Pilot not lighting.	<ol style="list-style-type: none"> 1. Gas supply is off. 2. Additional time needed to bleed air out of gas line. 3. Low gas pressure. 4. Pilot burner not adjusted properly. 5. Incorrect oven pilot orifice.
Burner flame too yellow	<ol style="list-style-type: none"> 1. Orifice incorrect size or dirty. 2. Air shutter not adjusted correctly or dirty. 3. Incorrect gas pressure. 4. Incorrect gas type. 5. Orifice misaligned in venturi. 6. Appliance not venting properly.
Slow to heat or not hot enough.	<ol style="list-style-type: none"> 1. Low gas pressure. 2. Thermostat out of calibration.
Oven temperature too hot.	<ol style="list-style-type: none"> 1. Thermostat out of calibration. 2. By-pass flame to high.
Low burner flame (all burners).	<ol style="list-style-type: none"> 1. Low gas pressure. 2. Incorrect gas type.
Low burner flame (individual burner).	<ol style="list-style-type: none"> 1. Air mixture incorrect.
Flame floats on burner.	<ol style="list-style-type: none"> 1. Inadequate air supply. 2. Restricted exhaust flue (ovens).

CONVECTION OVENS ONLY	
SYMPTOM	POSSIBLE CAUSE
Oven temperature too hot.	<ol style="list-style-type: none"> 1. Thermostat out of calibration.

CONVECTION OVENS ONLY	
SYMPTOM	POSSIBLE CAUSE
Convection motor does not operate.	<ol style="list-style-type: none"> 1. Main power supply not on. 2. Incorrect voltage. 3. Oven door switch arm not engaging door hinge arm properly. 4. Oven door switch open or inoperative. 5. Power switch open or inoperative. 6. Convection motor inoperative.
Convection motor noisy.	<ol style="list-style-type: none"> 1. Motor mounting bracket or motor mounting plate to the back of the chassis is loose. 2. Fan shroud is loose or fan is rubbing shroud. 3. Fan loose on motor shaft. 4. Fan excessively dirty or debris stuck in fan. 5. Motor malfunction.
Pilot does not remain lit (no gas flow to oven burner).	<ol style="list-style-type: none"> 1. Low gas pressure. 2. Thermocouple not positioned correctly or malfunctioning. 3. Solenoid malfunction. 4. Pilot gas flow too low. Adjust on gas safety valve.

