

**DXOC 27/1-AUS**



BORN INNOVATIVE

EN





Thank-you for choosing a **Hoover** washing machine. We are proud to always offer new, innovative and technologically advanced products, with a complete range of home appliances to ensure true assistance in your daily routine.

Carefully read this manual for correct and safe appliance use and for helpful tips on efficient maintenance.



Only use the washing machine after carefully reading these instructions. We recommend you always keep this manual on hand and in good condition for any future owners.

Please check that the appliance is delivered with this instruction manual, warranty certificate, water and energy efficiency label. Also check that plugs, curve for drain hose and liquid detergent or bleach tray (only on some models) are included. We recommend you keep all these components.

Each product is identified by a unique 16-character code, also called the “serial number”, printed on the sticker affixed to the appliance (porthole area) or in the document envelope found inside the product.

## Environmental conditions



This appliance is marked according to the European directive 2012/19/EU on Waste Electrical and Electronic Equipment (WEEE).

WEEE contains both polluting substances (which can cause negative consequences for the environment) and basic components (which can be re-used). It is important to have WEEE subjected to specific treatments, in order to remove and dispose properly all pollutants, and recover and recycle all materials. Individuals can play an important role in ensuring that WEEE does not become an environmental issue; it is essential to follow some basic rules:

- WEEE should not be treated as household waste;
- WEEE should be handed over to the relevant collection points managed by the municipality or by registered companies. In many countries, for large WEEE, home collection could be present.

In many countries, when you buy a new appliance, the old one may be returned to the retailer who has to collect it free of charge on a one-to-one basis, as long as the equipment is of equivalent type and has the same functions as the supplied equipment.

## Contents

1. **GENERAL SAFETY RULES**
2. **INSTALLATION**
3. **PRACTICAL TIPS**
4. **MAINTENANCE AND CLEANING**
5. **QUICK USER GUIDE**
6. **CONTROLS AND PROGRAMS**
7. **TROUBLESHOOTING AND WARRANTY**

# 1. GENERAL SAFETY RULES

- This appliances is intended to be used in household and similar applications such as:
  - Staff kitchen areas in shops, offices and other working environments;
  - Farm houses;
  - By clients in hotels, motels and other residential type environments;
  - Bed and breakfast type environments.A different use of this appliance from household environment or from typical housekeeping functions, as commercial use by expert or trained users, is excluded even in the above applications. If the appliance is used in a manner inconsistent with this it may reduce the life of the appliance and may void the manufacturer's warranty. Any damage to the appliance or other damage or loss arising through use that is not consistent with domestic or household use (even if located in a domestic or household environment) shall not be accepted by the manufacturer to the fullest extent permitted by law.
- This appliance is not intended for use by persons (including children) with reduced physical, sensory or mental capabilities, or lack of experience and knowledge, unless they have been given supervision or instruction concerning use of

the appliance by a person responsible for their safety. Children shall not play with the appliance. Cleaning and user maintenance shall not be made by children without supervision.

- Children should be supervised to ensure that they do not play with the appliance.
- Children of less than 3 years should be kept away unless continuously supervised.
- If the supply cord is damaged, it must be replaced by the manufacturer, its service agent or similarly qualified persons in order to avoid a hazard.
- Only use the hose-sets supplied with the appliance for the water supply connection (do not reuse old hose-sets).
- Water pressure must be between 0,05 MPa and 0,8 MPa.
- Make sure that carpet does not obstruct the base of the machine and ventilation openings.
- The OFF condition is reached by placing the reference mark on the programmes control/knob in the vertical position. Any other different position of such control sets the machine in ON condition (only for models with programmes knob).

- After installation, the appliance must be positioned so that the plug is accessible.
- The maximum load capacity of dry clothes is 7 kg.



**WARNING:**  
water may reach very high temperatures during the wash cycle.

**2**

### Electrical connections and safety instructions

- The technical details (supply voltage and power input) are indicated on the product rating plate
- Make sure that the electrical system is grounded, complies with all applicable law and that the (electricity) socket is compatible with the plug of the appliance. Otherwise, seek qualified professional assistance.
- The use of converters, multiple sockets or extension cords is strongly advised against.
- Before cleaning or maintaining the washing machine, unplug the appliance and turn off the water faucet.
- Do not pull on the power cord or appliance to unplug the machine.
- Make sure there is no water in the drum before opening the porthole.
- Do not expose the washing machine to rain, direct sunlight or other weather elements. Protect from possible freezing.
- When moving, do not lift the washing machine by the knobs or detergent drawer; during transport, never rest the porthole on the trolley. We recommend two people lift the washing machine.
- In the event of fault and/or malfunction, turn off the washing machine, close the water faucet and do not tamper with the appliance. Immediately contact the Customer Service Centre and only use original spare parts. Failure to observe these instruction may jeopardise appliance safety.

## 2. INSTALLATION

- Unscrew the **2** or **4** transit screws (**A**) on the back and remove the **2** or **4** washers (**B**) as illustrated in **figure 1**.
- Close the **2** or **4** holes using the plugs included in the instruction envelope.
- In some models, **1** or **more** washers will fall inside the machine: tilt the washing machine forward to remove them. Close the holes using the plugs found in the envelope. Keep the transit screws & parts for future use in case you move house.



### **WARNING:**

**keep packaging materials away from children.**

- Place the polionda sheet on the bottom as shown in **figure 2** (according to the model, consider version **A**, **B** or **C**).

**In some models this operation will not be necessary, because the corrugated plastic sheet will be already placed on the bottom of the appliance.**

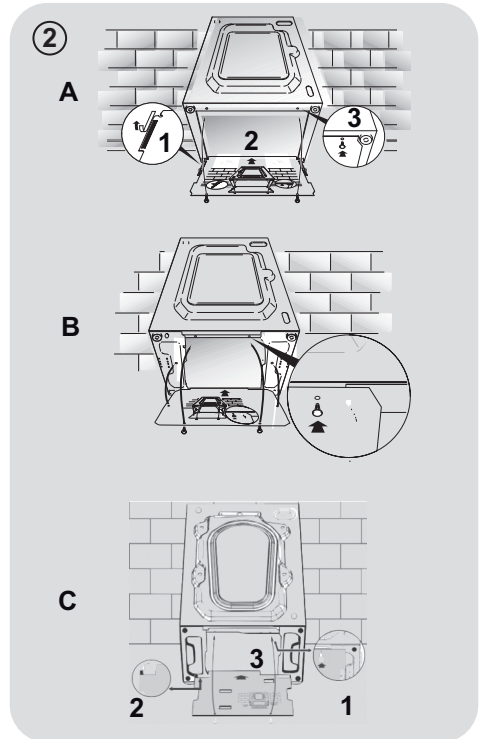
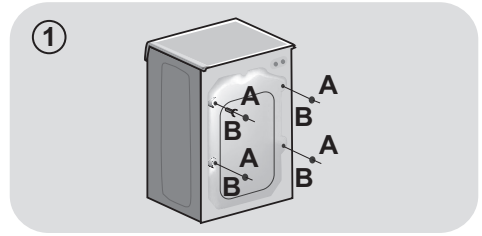

## Water connections

- Connect the water hose to the water supply faucet (**fig. 3**) only using the hose supplied with the appliance (do not reuse old hose-sets).
- Some models may include one or more of the following features:
- **HOT&COLD (fig. 4):** water mains connection settings with hot and cold water for higher energy savings. Connect the grey hose to the cold water faucet  and the red one to the hot water faucet. The machine can be connected to the cold water faucet only: in this case, some programs may start a few minutes later.

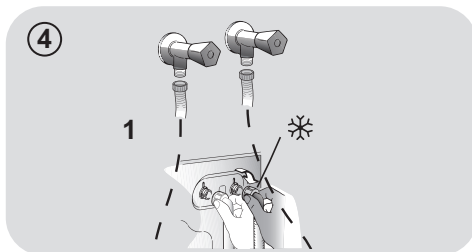
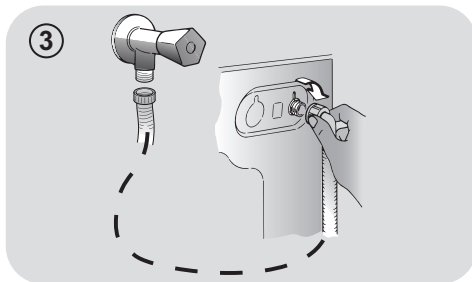

- **AQUASTOP (fig. 5):** a device located on the supply hose that stops water flow if the tube deteriorates; in this case, a red mark will appear in the window "A" and the hose must be replaced. To unscrew the nut, press the one-way lock device "B".

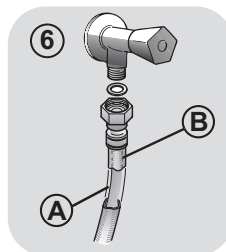
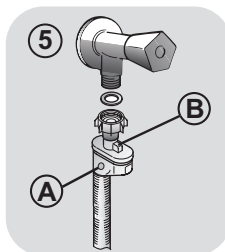

- **AQUAPROTECT – SUPPLY HOSE WITH GUARD (fig. 6):**

Should water leak from the primary internal hose "A", the transparent containment sheath "B" will contain water to permit the washing cycle to complete. At the end of the cycle, contact the Customer Service Centre to replace the supply hose.

## Setting

- The washing machine should be installed in its final position such that the water fill hose is not kinked or trapped. The corrugated drain hose should be inserted into a suitable drain pipe that is at a height between 50 cm and 85 cm above the floor using the curved drain hose support. If an under sink connection is used the drain hose must be routed above the sink overflow opening to prevent back siphoning. Care must be taken to avoid kinking or trapping the drain hose (**fig. 7**).

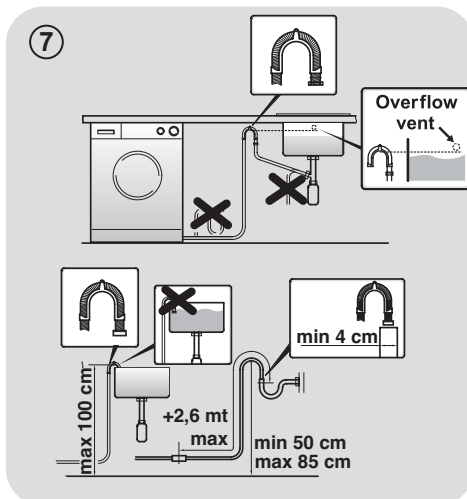

- Level the appliance using the feet as illustrated in **figure 8**:
  - a. turn the nut clockwise to release the screw;
  - b. rotate the foot to raise or lower it until it adheres to the floor;
  - c. lock the foot, screwing in the nut, until it adheres to the bottom of the washing machine.
- Plug in the appliance.

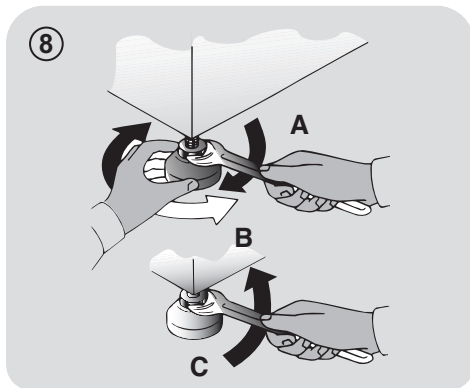

## WARNING:

contact the Customer Service Centre should the power cord need replacement.

## Detergent drawer

The detergent draw is split into 3 compartments as illustrated in **figure 9**:

- **compartment "1"**: for prewash detergent;
- **compartment "☼"**: for special additives, softeners, starch fragrances, etc.;
- **compartment "2"**: for washing detergent.

A **liquid detergent cup** is also included in **SOME MODELS (fig. 10)**. To use it, place it in **compartment "2"**. The cup can also be used for bleach when the "Rinse" program is selected.

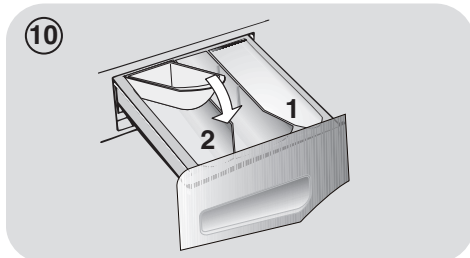
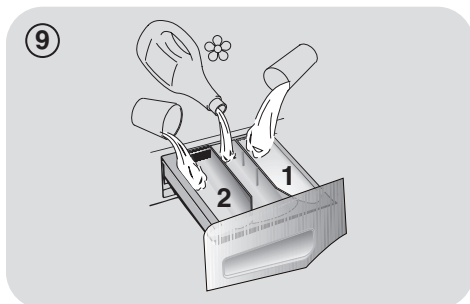

## WARNING:

Some liquid detergents are hard to dissolve. In this case we recommend diluting the detergent with warm water. We recommend you use only 20% of the recommended detergent quantities shown on the detergent pack.



## WARNING:

installation faults are not covered by the manufacturers warranty.

### 3. PRACTICAL TIPS

#### Load tips

**WARNING:** when sorting laundry, make sure:

- there are NO foreign objects such as coins, hair clips, pins, keys etc, etc, from the wash load. Check all pockets. Serious damage to the machine can result which may not be covered by warranty.
  - to have buttoned pillow cases, closed zips, tied loose belts and long robe ribbons;
  - to have removed rollers from curtains;
  - to have carefully read clothing washing labels;
  - to have removed any persistent stains using specific detergents.
- When washing rugs, bedcovers or other heavy clothing, we recommend you avoid spinning.
- To wash wool, make sure the item can be machine washed. Check the fabric label.

#### Helpful suggestions for the user

A guide to environmentally friendly and economic use of your appliance.

#### Maximise The Load Size

- Achieve the best use of energy, water, detergent and time by using the recommended maximum load size.
- Save up to 50% energy by washing a full load instead of 2 half loads.

#### Do you need to pre-wash?

- For heavily soiled laundry only!
- SAVE detergent, time, water and between 5 to 15% energy consumption by NOT selecting Prewash for slight to normally soiled laundry.

#### Is a hot wash required?

- Pretreat stains with stain remover or soak dried in stains in water before washing to reduce the necessity of a hot wash programme.

Save up to 50% energy by using a 60°C wash programme.

#### Before using a drying programme (WASHER-DRYERS)

- SAVE energy and time by selecting a high spin speed to reduce the water content in laundry before using a drying programme.

Following is a **quick guide** with tips and recommendations on **detergent use at the various temperatures**. In any case, always read the instructions on the detergent for correct use and doses.

**When washing heavily soiled whites, we recommend using cotton programs of 60°C or above and a normal washing powder (heavy duty) that contains bleaching agents that at medium/high temperatures provide excellent results.**

**For washes between 40°C and 60°C** the type of detergent used needs to be appropriate for the type of fabric and level of soiling.

Normal powders are suitable for “white” or colour fast fabrics with high soiling, while liquid detergents or “colour protecting” powders are suitable for coloured fabrics with light levels of soiling.

**For washing at temperatures below 40°C** we recommend the use of liquid detergents or detergents specifically labeled as suitable for low temperature washing.

Please note - dilute viscous liquid detergent with warm water if necessary.

For washing **wool** or **silk**, only use detergents specifically formulated for these fabrics.

## 4. MAINTENANCE AND CLEANING

To clean the washing machine exterior, use a damp cloth, avoiding abrasives, alcohol and/or solvents. The washing machine does not require any special care for ordinary cleaning: clean drawer compartments and the filter; some tips on how to move the machine or on long periods of disuse are provided below.

### Drawer cleaning

- We recommend you clean the drawer to avoid accumulating detergent and additive residue.
- To do this, extract the drawer using slight force, clean it with running water and reinsert it in its housing.

### Filter cleaning

- The washing machine comes with a special filter able to trap large residue, such as buttons or coins, which could clog the drain.
- **ONLY AVAILABLE ON CERTAIN MODELS:** pull out the corrugated hose, remove the stopper and drain the water into a container.
- Before unscrewing the filter, we recommend you place an absorbent cloth under it to keep the floor dry.
- Turn the filter counter-clockwise.
- Remove and clean the filter; when finished, replace it turning it clockwise.
- Repeat the previous steps in reverse order to reassemble all parts.

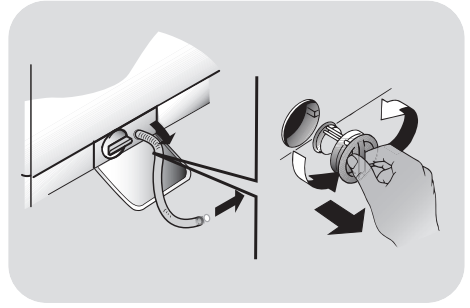

### Suggestions for moves or prolonged disuse

- If the washing machine will not be used for an extended amount of time and will be stored in a cold area ensure all water is drained from the hoses to prevent freezing.
- Unplug the washing machine.
- Detach the hose from the strap and lower it, fully draining water into a bowl.
- Secure the drain hose with the strap when finished.



**WARNING:**  
unplug the machine prior to cleaning.

## 5. QUICK USER GUIDE

This washing machine automatically adjusts the level of the water to the type and quantity of washing. This system gives a reduction in energy consumption and a saving in washing times.

### Program selection

- Turn on the washing machine and select the required program.
- Adjust the washing temperature if necessary and press the required "option" buttons.
- Press the **START/PAUSE** button to start washing.

*Should power go out when the washing machine is running, a special memory saves the settings and, when power returns, the machine resumes the cycle from where it left off.*

- At the end of the programme, the message "End" will appear on the display or, on some models, all wash stage indicator lights will turn on.

Wait until the **DOOR LOCKED** light has gone out before opening the door.

- Turn off the washing machine.

For any type of wash, see the program table and follow the operating sequence as indicated.

### Technical data

#### Water pressure:

min 0.05 Mpa / max 0.8 Mpa  
(0.05 MPa dispenses approximately 1 litre of water in 10 seconds)

**Spin r.p.m.:** See rating plate.

**Power input / Power current fuse amp / Supply voltage:** See rating plate.

## 6. CONTROLS AND PROGRAMS

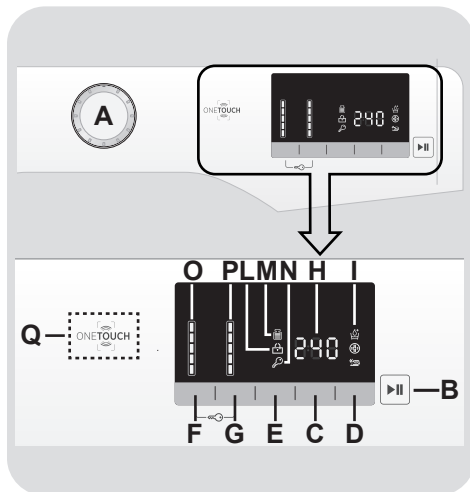

**A Programme selector with OFF position**

**B START/PAUSE button**

**C DELAY START button**

**D OPTIONS button**

**E RAPID / STAIN LEVEL button**

**F TEMPERATURE SELECTION button**

**G SPIN SPEED button**

**F+G KEY LOCK**

**H Digital display**

**I OPTIONS indicator lights**

**L DOOR LOCKED indicator light**

**M KG MODE indicator light**

**N KEY LOCK indicator light**

**O TEMPERATURE SELECTION indicator lights**

**P SPIN SPEED indicator lights**

**Q ONE TOUCH area**

## Opening the door

A special safety device prevents the door from being opened immediately after the end of the cycle.

Wait for **2 minutes** after the wash cycle has finished and the "Door Security" light has gone out before opening the door.

## PROGRAMME selector with OFF position

When the programme selector is turned the display lights up to show the settings for the programme selected.

For energy saving, at the end of the cycle or with an inactivity period, the display level contrast will decrease.

**N.B.:** To switch the machine off, turn the programme selector to the **OFF** position.

- Press the **START/PAUSE** button to start the selected cycle.
- Once a programme is selected the programme selector remains stationary on the selected programme until the cycle ends.
- Switch off the washing machine by turning the selector to **OFF**.

The programme selector must be returned to the **OFF** position at the end of each cycle or when starting a subsequent wash cycle prior to the next programme being selected and started.

## START/PAUSE button

Close the door **BEFORE** selecting the button **START/PAUSE**.

- Press to start the selected cycle.

When the **START/PAUSE** button has been pressed, the appliance can take few seconds before it starts working.

## ADD OR REMOVE ITEMS AFTER THE PROGRAMMES HAS STARTED (PAUSE)

- Press and hold the **START/PAUSE** button for about **2 seconds** (some indicator lights and the time remaining indicator will flash, showing that the machine has been paused).
- Wait **2 minutes** until the safety device unlocks the door.

Before you open the door, please check the water level is below the door opening to avoid flooding.

- After you have added or removed items, close the door and press the **START/PAUSE** button (the programme will start from where it left off).

## CANCELLING THE PROGRAMME

- To cancel the programme, set the selector to the **OFF** position.

## DELAY START button

- This button allows you to pre-programme the wash cycle and delay the start of the cycle for up to **24 hours**.
- To delay the start use the following procedure:

- Select the required programme.
- Press the delay start button once to activate it (**h00** appears on the display) and then press it again to set a **1 hour** delay (**h01** appears on the display). The pre-set delay increases by **1 hour** each

time the button is pressed, until **h24** appears on the display, at which point pressing the button again will reset the delay start to zero.

- Confirm by pressing the **START/PAUSE** button (the light on the display starts to flash). The delay countdown will begin and when it has finished the programme will start automatically.

- It is possible to cancel the delay start by turning the programme selector to **OFF**.

*If there is any break in the power supply while the machine is operating, a special memory stores the selected programme and, when the power is restored, it continues where it left OFF.*

The option buttons should be selected before pressing the **START/PAUSE** button.

### OPTIONS button

This button allows you to choose between three different options:

#### - EXTRA RINSE

- This option allows you to add one rinse at the end of the washing cycle and is useful for people with delicate and sensitive skin, for which a small amount of detergent residue can cause irritations or allergies.
- It is advisable to also use this function for the children clothes and for the washing of heavily soiled items, which requires a lot of detergent to be used, or for the washing of toweling items whose fibres mostly have the tendency to hold the detergent.

#### - HYGIENE +

Activated when you set 60°C of temperature. This option allows deep cleaning of your clothes by maintaining the same temperature for the whole wash.

### - EASY IRON

This function allows you to minimize creases as much as possible, eliminating the intermediate spins or reducing the intensity of the last one.

If an option is selected that is not compatible with the selected programme then the option indicator light first flashes and then goes off.

### RAPID / STAIN LEVEL button

This button allows you to choose between two different options, depending on the selected programme.

#### - RAPID

The button becomes active when you select the **RAPID (14/30/44 Min.)** programme on the knob and allows you to select one of three durations indicated.

#### - STAIN LEVEL button

- Once the programme has been selected the wash time set for that programme will be automatically shown.
- This option allows you to choose between 3 levels of wash intensity modifying the length of the programme, depending on how much the fabrics are soiled (can only be used on some programmes as shown in the table of programmes).

### TEMPERATURE SELECTION button

- This button allows you to change the temperature of the wash cycles.
- It is not possible to raise the temperature over the maximum allowed for the programme, in order to protect the fabrics.
- If you want carry out a cold wash all the indicators must be off.

## SPIN SPEED button

- By pressing this button, it is possible to reduce the maximum speed, and if you wish, the spin cycle can be cancelled.
- If the label does not indicate specific information, it is possible to use the maximum spin expected in the program.

**To prevent damage to the fabrics, it is not possible to increase the speed over the maximum allowed for the programme.**

- To reactivate the spin cycle press the button until you reach the spin speed you would like to set.
- It is possible to modify the spin speed without pausing the machine.

**An over dosing of detergent can cause excessive foaming. If the appliance detects the presence of excessive foam, it may exclude the spinning phase or extend the duration of the program and increase water consumption.**

**The machine is fitted with a special electronic device, which prevents the spin cycle should the load be unbalanced. This reduces the noise and vibration in the machine and so prolongs the life of your machine.**

## KEY LOCK

- Pressing simultaneously the buttons **TEMPERATURE SELECTION** and **SPIN SPEED** for about **3 seconds**, allows you to lock the keys. This will prevent accidental or unwanted changes if a button on the display is pressed accidentally during a cycle.

- The key lock can be simply cancelled by pressing the two buttons simultaneously again or turning off the appliance.

## Digital Display

The display's indicator system allows you to be constantly informed about the status of the machine.

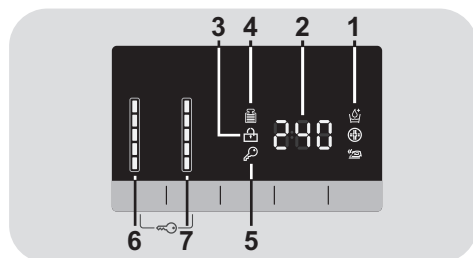

### 1) OPTIONS INDICATOR LIGHTS

The indicator lights show the options that can be selected by the relevant button.

### 2) CYCLE DURATION

- When a programme is selected the display automatically shows the cycle duration, which can vary, depending on the options selected.
- During the initial filling phase of the cycle the machine calculates the actual cycle time needed based on the load size, content and options selected. The real time of the wash will then be displayed. This time can recalculate during the wash depending on detergent levels and load balancing.

### 3) DOOR LOCKED INDICATOR LIGHT

- The indicator light is illuminated when the door is fully closed.

**Close the door BEFORE selecting the START/PAUSE button.**

- When **START/PAUSE** is pressed on the machine with the door closed, the indicator will flash momentarily and then illuminate.

- adjusts the spin speed according to the load, thus avoiding any imbalance.

#### 5) KEY LOCK INDICATOR LIGHT

The indicator light shows that the keys are locked.

#### 6) WASH TEMPERATURE INDICATOR LIGHTS

This shows the washing temperature of the selected programme that can be changed (where allowed) by the relevant button.

If you want carry out a cold wash all the indicators must be off.

#### 7) SPIN SPEED INDICATOR LIGHTS

This displays the spin speed of the selected programme it can be changed or omitted by the relevant button.

**If the door is not properly closed, the light will continue to flash for about 7 seconds, after which the start command will be automatically cancelled. In this case, close the door in the proper way and press the START/PAUSE button.**

- A special safety device prevents the door from being opened immediately after the end of the cycle. Wait for **2 minutes** after the wash cycle has finished and the **DOOR LOCKED** light has gone out before opening the door. At the end of the cycle turn the programme selector to **OFF**.

#### 4) Kg Mode INDICATOR LIGHT (*function active only on Cotton and Synthetics programmes*)

- During the first minutes of the cycle, the **"Kg MODE"** indicator remains on while the intelligent sensor will weigh the laundry and adjust the cycle time, water and electricity consumption accordingly.

- The **"Kg MODE"** displays information on the wash load. During the first couple of minutes, it will:

- adjusts the amount of water required;
- determines the length of the wash cycle;
- controls rinsing according to the type of fabric selected to be washed;
- adjusts the rhythm of drum rotation for the type of fabric being washed;
- recognizes the presence of lather, increasing, if necessary, the amount of water during rinsing;
- adjusts the spin speed according to the load, thus avoiding any imbalance.

## ONE TOUCH

This appliance is equipped with **One Touch** technology that allows you to interact, via the App, with smartphones based on Android operating system and equipped with NFC (Near Field Communication) function.

- Download on your smartphone the **Hoover Wizard** App.

The **Hoover Wizard** App is available for devices running both Android and iOS, both for tablets and for smartphones. However, you can interact with the machine and take advantage of the potential offered by One Touch only with Android smartphones equipped with NFC technology, according to following functional scheme:

Android smartphone with NFC technology	Interaction with the machine + contents
Android smartphone without NFC technology	Contents only
Android Tablet	Contents only
Apple iPhone	Contents only
Apple iPad	Contents only

## FUNCTIONS

The main functions available using the App are:

- **Voice Coach** – A guide to help you choose the ideal cycle with only three voice inputs (clothes/fabrics, color, stain level).
- **Programmes** – To download and launch new washing programmes.

- **Clever Care** – Clever Check-up and Auto-Hygiene cycles and a troubleshooting guide.
- **Reports** – Washing statistics and tips for a more efficient use of your machine.

Get all the details of the One Touch functions, browsing the App in DEMO mode or go to:  
[www.hooveronetouch.com](http://www.hooveronetouch.com)

## HOW TO USE ONE TOUCH

### FIRST TIME - Machine registration

- Enter the "Settings" menu of your Android smartphone and activate the NFC function inside the "Wireless & Networks" menu.

Depending on the smartphone model and its Android OS version, the process of the NFC activation may be different. Refer to the smartphone manual for more details.

- Turn the knob to the **One Touch** position to enable the sensor on the dashboard.
- Open the App, create the user profile and register the appliance following the instructions on the phone display or the "Quick Guide" attached on the machine.

More information, F.A.Q. and the video for an easy registration are available on:  
[www.hooveronetouch.com/how-to](http://www.hooveronetouch.com/how-to)

## NEXT TIME – Regular usage

- Every time you want to manage the machine through the App, first you have to enable the **One Touch** mode by turning the knob to the **One Touch** indicator.
- Make sure you have unlocked your phone (from stand-by mode) and you have activated the NFC function following the steps mentioned earlier.
- If you want to start a washing cycle, load the laundry, the detergent and close the door.
- Select the desired function in the App (e.g.: starting a programme, the Clever Check-up cycle, update statistics, etc...).
- Follow the instructions on the phone display, **KEEPING IT ON** the **One Touch** logo on the machine dashboard, when requested to do so by the App.



### NOTES:

Place your smartphone so that the NFC antenna on its back matches the position of the One Touch logo on the appliance (as illustrated below).









If you do not know the position of your NFC antenna, slightly move the smartphone in a circular motion over the One Touch logo until the App confirms the connection. In order for the data transfer to be successful, it is essential **TO KEEP THE SMARTPHONE ON THE DASHBOARD DURING THESE FEW SECONDS OF THE PROCEDURE**; a message on the device will inform about the correct outcome of the operation and advise you when it is possible to move the smartphone away.

Thick cases or metallic stickers on your smartphone could affect or prevent the transmission of data between machine and telephone. If necessary, remove them.

The replacement of some components of the smartphone (e.g. back cover, battery, etc...) with non-original ones, could result in the NFC antenna removal, preventing the full use of the App.

The management and the control of the machine via App is only possible "by proximity": it is therefore not possible to perform remote operations (e.g.: from another room; outside of the house).

## Table of programmes

 <b>PROGRAMME</b>	 (MAX.) (see control panel)	 °C (MAX.)	1) 			
			2		1	
<b>Rapid<sup>3)</sup></b> 14-30-44 Min.	14'	1	30°	●	●	
	30'	2,5	30°	●	●	
	44'	3,5	40°	●	●	
<b>Daily 59 Min.</b>	2,5	60°	●	●		
<b>Mixed</b>	3,5	60°	●	●		
<b>Handwash &amp; Wool</b>	1	30°	●	●		
<b>Delicates</b>	2,5	40°	●	●		
<b>Sports</b>	3	30°	●	●		
<b>Dark Colours</b>	3,5	40°	●	●		
<b>Rinse</b>	-	-	△	●		
<b>Drain &amp; Spin</b>	-	-				
<b>Baby Hygiene 60°C</b>	4,5	60°	●	●		
<b>ActivEco 20°C</b>	7	20°	●	●		
	* 2)	7	60°	●	●	
<b>Whites + Prewash</b>	7	60°	●	●	●	
<b>Whites</b>	7	90°	●	●		

**One Touch** 

Customizable setting that interacts with the App on your smartphone and to download the cycles (see the dedicated section). The factory sets the default programme Auto-Hygiene, which will sanitize the machine.

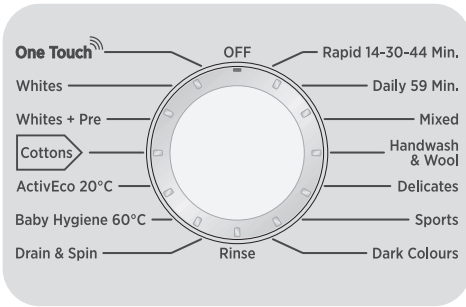

**Please read these notes:**

\* Programme tested in accordance with AS/NZS 2040.2 with a temperature of 40°C.

Programme also recommended for low-temperature washes (lower than the max. shown).

The "Cottons" programme at 40 deg.C, 1000 RPM spin with "Max soil Level" setting is the program recommended for a normally soiled load at the rated capacity 7 kg."

**△ (Only for models with liquid detergent compartment)**

When only a limited number of articles have stains which require treatment with liquid bleaching agents, preliminary removal of stain can be carried out in the washing machine.

Pour the bleach into the liquid bleach container, inserted into the compartment marked "2" in the detergent drawer, and set the special programme RINSE.

When this phase has terminated, turn the programme selector to the OFF position, add the rest of the fabrics and proceed with a normal wash on the most suitable programme.

- 1) When a programme is selected, the display shows the recommended wash temperature, it can be reduced (where allowed) by the relevant button.
- 2) For the programmes shown you can adjust the duration and intensity of the wash using the STAIN / SOIL LEVEL button.
- 3) If the RAPID program is selected with the knob, the rapid programs 14', 30' and 44' will become available to select by using the RAPID button.

## Programmes selection

To clean different types of fabrics and various levels of soil, the washing machine has specific programs to meet every need of washing (see table of programmes).

### Rapid (14-30-44 Min.)

Washing cycle suggested for low loads and slightly soiled. With this program it is recommended to reduce the quantity of detergent normally used, in order to avoid unnecessary waste. Selecting the RAPID program and acting on the button you can choose one of three programs available.

### Daily 59 Min.

This specially designed programme maintains the high quality wash performance whilst greatly reducing the wash time. The programme is designed for a reduced load (see table of programmes).

### Mixed

The washing and rinsing optimise the speed and rhythm of the drum action and water levels. The gentle spin, ensures a reduced formation of creases in the fabric.

### Handwash & Wool

This program performs a wash cycle dedicated to the wool fabrics that can be washed in a washing machine, or the articles to be washed by hand.

### Delicates

This program has reduced periods of drum rotation during the cycle and is particularly suitable or washing delicate fabrics. The wash cycle and rinses are carried out with a high level of water to ensure the best performance.

### Sports

This programme is specially designed to wash mixed sportswear fabrics that cannot be washed on hotter programmes and is designed to remove the dirt and staining created by participation in sports activities.

### Dark Colours

Program designed to mix all dark garments and to avoid the loss of colour and the formation of creases. We recommend the use of liquid detergent.

### Rinse

This program performs 3 rinses with an intermediate spin (which can be reduced or excluded by using the appropriate button). It is used for rinsing any type of fabric, for example after a wash carried out by hand.

### Drain & Spin

The program completes the drain and a maximum spin. It is possible to delete or reduce the spin with the SPIN SPEED button.

### Baby Hygiene 60°C

This program allows you to wash all baby clothes getting a perfect clean and sanitizing effect, setting the temperature at 60°C minimum.

To optimize the result of the sanitizing effect we recommend the use of powder detergent.

### ActivEco 20°C

This innovative programme, allows you to wash different fabrics and colours together, such as cottons, synthetics and mixed fabrics at only 20°C and provides an excellent cleaning performance. Consumption on this program is about 40% of a conventional 40°C. cottons wash.

### Cottons

This program is suitable to clean normally soiled cotton laundry and it is the most efficient program in terms of combined energy and water consumptions for washing cotton laundry (when selected at 40°C, maximum stain / soil level, 1000 RPM spin speed).

### Whites + Prewash

This programme has been designed to remove the stronger stains from cotton white clothes. The prewash guarantees the tough dirt removal. Add into compartment "1" a quantity of detergent equal to 20% of that used for main wash.

### Whites

An intensive wash. The final spin at maximum speed gives more efficient removal.

## One Touch

Customizable setting of the knob that you have to select when you would like to transfer a command from the App to the machine and to download/start a cycle (see the dedicated section and the user manual of the App for more info).

In the **One Touch** option the factory sets as a default the **"Auto-Hygiene"** cycle, made

to clean the drum, remove bad smells and extend the life of the washing machine.

Make sure there is no load in the drum before starting the Auto-Hygiene cycle, use a proprietary washing machine cleaning agent or powder detergent. Leave the door of the machine open at the end of the cycle to allow the drum to dry.

Recommended every 50 washes.

## 7. TROUBLESHOOTING AND WARRANTY

If you believe the washing machine is not working correctly, consult the quick guide provided below which includes some practical tips on how to fix the most common problems.

### FOR ONE TOUCH MODELS

The *Hoover Wizard* app has a **Clever Check-up** function that allows you to confirm the functionality and status of the product at any time. To use the *Hoover Wizard* app you will need an Android smartphone with NFC technology. More info can be found on the App.

If the display of the machine is showing an error (by a code or blinking LEDs), you should turn on the App on your Android smartphone, with NFC on. Place your smart phone against the One Touch logo on the control panel. You should now be able to read the fault directory to solve the issue.

### ERROR CODE FORMAT

- **Models with a display:** the error is shown by a number preceded by the letter “E” (example: E2 = Error 2).
- **Models without display:** an error is shown by a sequence of flashes of every LED. The error code is shown by the number of flashes followed by a pause of 5 seconds (example: two flashes – pause 5 seconds – two flashes – repeating = Error 2).

<b>Error shown</b>	<b>Possible causes and practical solutions</b>
<b>E2 (with display)</b> <b>2 flashes of the LEDs</b> (without display)	<b>The machine cannot load water.</b>
	Make sure the water supply tap is open.
	Make sure the water supply hose isn't bent, kinked or trapped.
	Make sure the drain pipe is at the proper height (see installation section).
<b>E3 (with display)</b> <b>3 flashes of the LEDs</b> (without display)	Close the water supply tap, unscrew the filler hose from the back of the washing machine and make sure the “anti-sand” filter is clean and not blocked.
	<b>The washing machine does not drain water.</b>
	Make sure the filter is not clogged.
	Make sure the drain hose isn't bent, kinked or trapped.
<b>E4 (with display)</b> <b>4 flashes of the LEDs</b> (without display)	Make sure the home drainage system is not blocked and is allowing water to flow through without obstruction. Try to drain the water in the sink.
	<b>There is too much foam and/or water.</b>
<b>E7 (with display)</b> <b>7 flashes of the LEDs</b> (without display)	Ensure the correct amount of detergent is being used and the detergent is designed for use in a washing machine.
	<b>Door problem.</b>
	Make sure the door is correctly closed. Make sure the clothes inside the drum are not preventing the door from closing fully.
<b>Any other code</b>	If the door is locked, turn off and unplug the washing machine from the electrical supply socket, wait 2-3 minutes and reopen the door.
	Turn off and unplug the washing machine, wait a minute. Turn on the machine and restart a program. If the error occurs again contact an Authorised Customer Service Centre directly.

## OTHER ANOMALIES

EN

Problem	Possible causes and practical solutions
<p><b><i>The washing machine does not work / start</i></b></p>	Make sure the product is plugged into a working supply socket.
	Make sure power is on.
	Make sure the wall socket is working, testing it with another appliance such as a lamp.
	The door may not be correctly closed: open and close it again.
	Check whether the required program was correctly selected and the start button pressed.
<p><b><i>Water leaked on the floor near the washing machine</i></b></p>	This may be due to a leak from the seal between the tap, supply hose and fill valve; in this case, replace it and tighten the hose connections correctly.
	Make sure the front filter is correctly closed.
<p><b><i>The washing machine does not spin</i></b></p>	The machine is fitted with a detection system that protects the load and product from damage if the load is not balanced before spinning. This may result in:-
	<ul style="list-style-type: none"> <li>• The machine attempts to balance the load, increasing the time of spin.</li> <li>• Reduction of the speed of spin to decrease vibrations and noise.</li> <li>• The spin cycle aborting to protect the machine and load.</li> </ul>
	If this is experienced remove the load de-tangle it, reload it and restart the spin program.
	This could be due to the fact that water has not been completely drained: wait a few minutes. If the problem persists, see Error 3 section.
	Some models include a "no spin" function: make sure it is not selected.
<p><b><i>Strong vibrations / noises are heard during the spin cycle</i></b></p>	Check which options are selected and their effect on the spin cycle.
	Excessive detergent can impede the spin cycle, ensure the correct amount of detergent is being used.
	The washing machine may not be fully levelled: if necessary, adjust the feet as indicated in the specific section.
	Make sure transport screws, rubber bungs and spacer tubes were removed.
Make sure there are no foreign objects inside the drum (coins, hinges, buttons, etc...).	

**The standard manufacturer warranty covers faults caused by electrical or mechanical faults in the product due to an act or omission of the manufacturer. If a fault is found to be caused by factors outside the product supplied, misuse or as a result of the instructions on use not being followed, a charge may be applied.**

The use of ecological detergents without phosphates may cause the following effects:

- **cloudier rinse drain water:** This effect is tied to the suspended zeolites which do not have negative effects on rinse efficiency.
- **white powder (zeolites) on laundry at the end of the wash:** this is normal, the powder is not absorbed by fabric and does not change its colour.  
To remove the zeolites, select a rinse programme. In the future consider using slightly less detergent.
- **foam in the water at last rinse:** this does not necessary indicate poor rinsing. Consider using less detergent in future washes.
- **abundant foam:** This is often due to the anionic surfactants found in the detergents which are hard to eliminate from laundry.  
In this case, do not re-rinse to eliminate these effects: it will not help at all.  
We suggest conducting a maintenance wash using a proprietary cleaner.

If the problem persists or if you suspect a malfunction, immediately contact an Authorised Customer Service Centre.

It is always recommended to use original spare parts, that are available at our Authorised Customer Service Centres.

#### **Warranty**

The product is guaranteed under the terms and conditions stated on the certificate included with the product. Proof of purchase must be made available at the time of any warranty related repair.

**The manufacturer declines all responsibility for any printing errors in the booklet included with this product. Moreover, it also reserves the right to make any changes deemed useful to its products without changing their essential characteristics.**

## WIRELESS PARAMETERS

(for model with Wi-Fi function)

Parameter	Specifications
Wireless Standard	802.11 b/g/n
Frequency range	2.412 GHz. - 2.484 GHz.
Max Trasmit Power	802.11b (11Mbps) +18,5 ± 2 dBm
	802.11g (54Mbps) +16 ± 2 dBm
	802.11n (HT20, MCS7) +14 ± 2 dBm
Minimum Receiving Sensitivity	802.11b (11Mbps) -93 dBm
	802.11g (54Mbps) -85 dBm
	802.11n (HT20, MCS7) -82 dBm

With this the Candy Hoover Group Srl, declares that this appliance marked with

**CE** complies with the essential requirements of the Directive 2014/53/EU. To receive a copy of the declaration of conformity, please contact the manufacturer at:  
[www.candy-group.com](http://www.candy-group.com)

## WIRELESS PARAMETERS

(for model with NFC function)

Parameter	Specifications
Wireless Standard	ISO/IEC 14443 Type A and NFC Forum Type 4
Frequency band	13.553-13.567 MHz (centre frequency 13.560 MHz)
Magnetic field limit	< 42dBµA/m (at 10 meters)

With this the Candy Hoover Group Srl, declares that this appliance marked with

**CE** complies with the essential requirements of the Directive 2014/53/EU. To receive a copy of the declaration of conformity, please contact the manufacturer at:  
[www.candy-group.com](http://www.candy-group.com)





