



User Guide

Smart Wi-Fi Light Switch Tapo S500

Contents

About This Guide	1
Introduction	2
Appearance	3
Wire Your Switch	4
Set Up Your Switch	7
Main Device Controls	8
Schedule	10
Away Mode	12
Timer	14
Check Runtime	16
Device Sharing	17
Smart Actions	18
Device Settings	23
How to Reset Your Switch	24
Authentication	26

About This Guide

This guide provides a brief introduction to the Smart Wi-Fi Light Switch and the Tapo app, as well as regulatory information.

Please note that features available in Tapo may vary by model and software version. Tapo availability may also vary by region. All images, steps, and descriptions in this guide are only examples and may not reflect your actual Tapo experience.

Conventions

In this guide, the following convention is used:

Convention	Description
Blue	Key information appears in blue, including management page text such as menus, items, buttons and so on.
<u>Underline</u>	Hyperlinks are in blue and underlined. You can click to redirect to a website.
📌Note:	Ignoring this type of note might result in a malfunction or damage to the device.

More Info

- Specifications can be found on the product page at <https://www.tapo.com>.
- Our Technical Support and troubleshooting information can be found at <https://www.tapo.com/support/>.

Introduction

Make your traditional lighting smart with the Tapo Smart Wi-Fi Light Switch. Turn your lights on and off with your voice, or control them from your phone.



Voice Control



Smarter with Sensor



Schedule & Timer



Away Mode



Easy Installation

- Voice Control – Manage your smart switch with simple voice commands via Amazon Alexa, Google Assistant, or Samsung Bixby.
- Remote Control – Instantly turn connected devices on/off from wherever you are through the Tapo app.
- Schedule – Preset a schedule to automatically manage devices.
- Auto-Off – Automatically turns off a connected device after the device is left on for a set time.
- Away Mode – Randomly turns devices on and off at different times to give the appearance that someone is home.
- Easy Installation – Interchangeable Load and Line terminals guarantee hassle-free installation
- Smarter with Sensors – Create Smart Actions triggered by Tapo smart sensors for greater automation.

Appearance

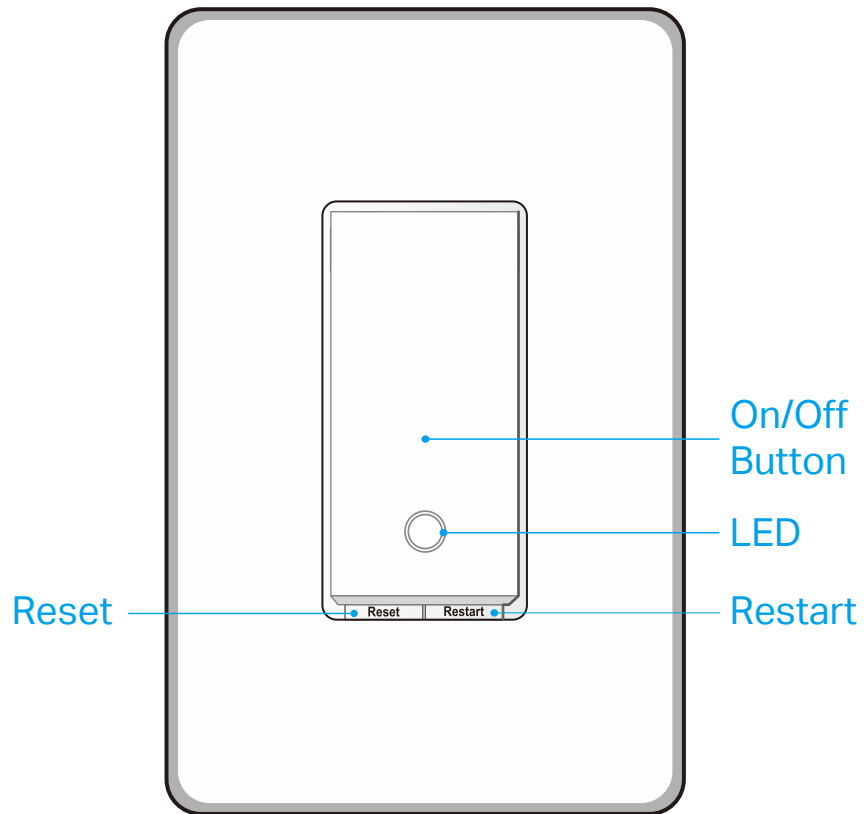

Button Explanations

Reset	Press and hold for about 5s to reset Wi-Fi while keeping other settings. Press and hold for about 10s to restore your switch to factory default settings.
Restart	Press to restart your switch.

LED Status

Solid amber	Starting up; disconnected from cloud.
Blinking amber & green	Ready for setup.
Blinking green	Connecting to Wi-Fi.
Stay green for 30s	Connected to Wi-Fi.
Solid red	Disconnected from Wi-Fi.
Blinking amber	Device resetting.
White	Light fixture is off.
Blinking green slowly	Firmware upgrading.

Wire Your Switch

Follow the steps below to wire your Smart Wi-Fi Light Switch. If you are not familiar with basic electrical wiring, please consult an electrician.

Before You Start

1. Prepare Basic knowledge of Wiring

- **Ground:** Usually green or copper.
- **Neutral:** Usually white, not connected to the dumb switch.
- **Line:** Usually black and coming from the circuit breaker.
- **Load:** Usually black. One end is connected to the light.

▀Note: If you are unsure, consult a qualified electrician.

2. Prepare Your Tools

Prepare a philips and slotted screwdriver, pliers, wire strippers and a voltage detector.

3. Check Wi-Fi Strength

Make sure your switch is in a area with strong Wi-Fi signal.

Wire Your Switch

Step 1. Turn Off Power and Remove the Wallplate

Turn off the circuit breaker. Then remove the old wallplate of the wall switch and label the wires.

CAUTION
Risk of Electric Shocks - High Voltage - Disconnect power supply before servicing.

MISE EN GARDE
Risque d'électrocution - Haute tension. Débrancher l'alimentation électrique avant d'utiliser.

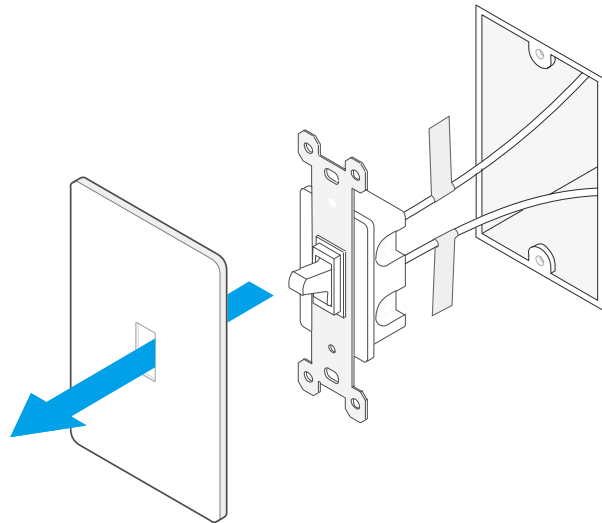

Step 2. Expose Your Switch Wiring

Remove the screws securing your old switch to the wall box. Gently pull the switch out and disconnect wires from the old switch.

Step 3. Label and Connect the Wires

Label the wires. Use the wire nuts to connect your smart switch to the wall box as shown below.

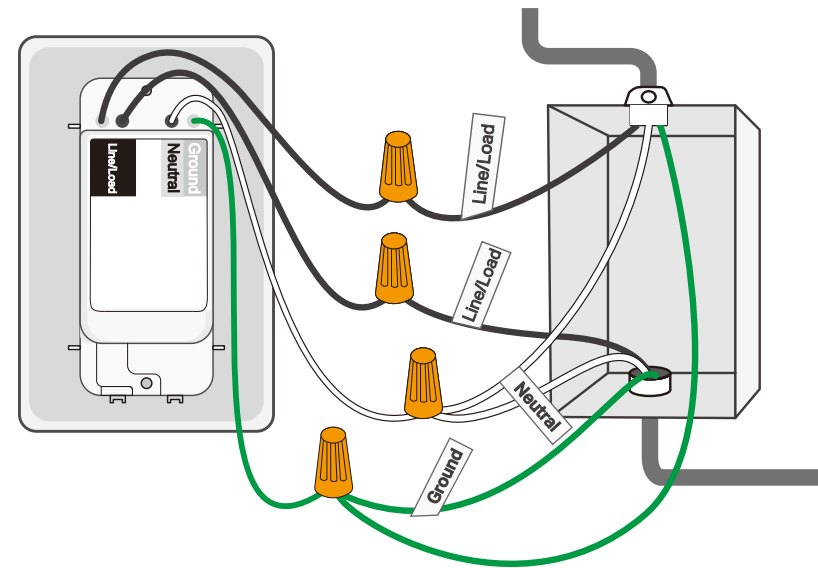

■ Note: No need to distinguish between Line and Load wires.

Step 4. Install Smart Light Switch

Gently fold all of the wires back into the wall box. Line up the switch with the mounting holes. Secure it with screws.

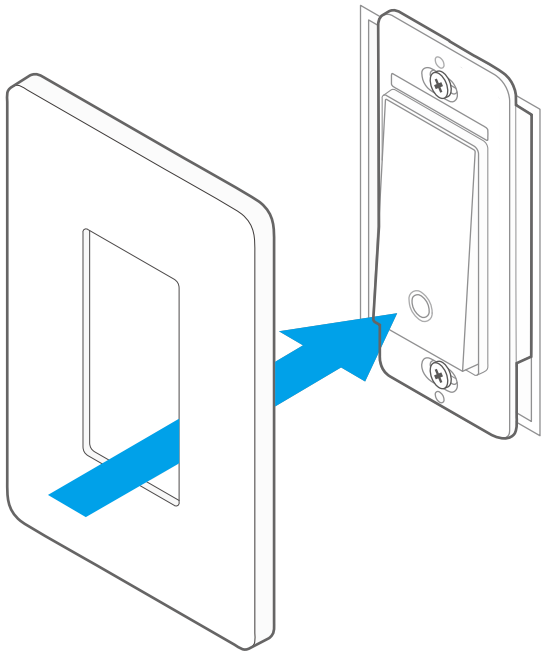

Step 5. Attach the Wallplate and Turn on Power

Attach the wallplate and turn on the circuit breaker. Then the wiring is finished.

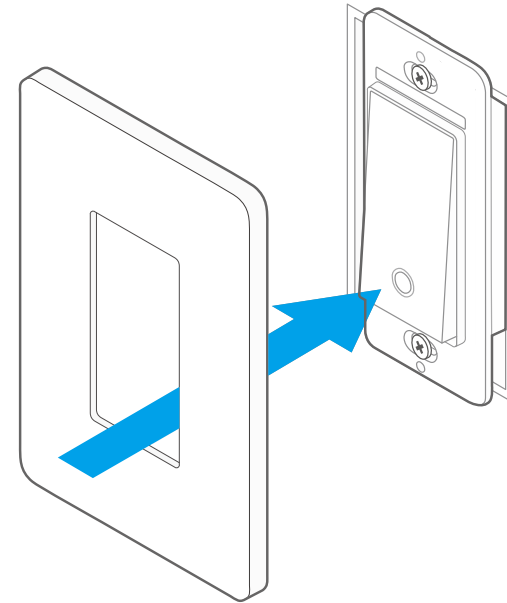

Set Up Your Switch

Follow the steps below to set up your switch.

Step 1. Download Tapo App

Get the Tapo app from the App Store or Google Play, or by scanning the QR code below.



OR



Step 2. Log In

Open the app, and log in with your TP-Link ID. If you don't have an account, create one first.

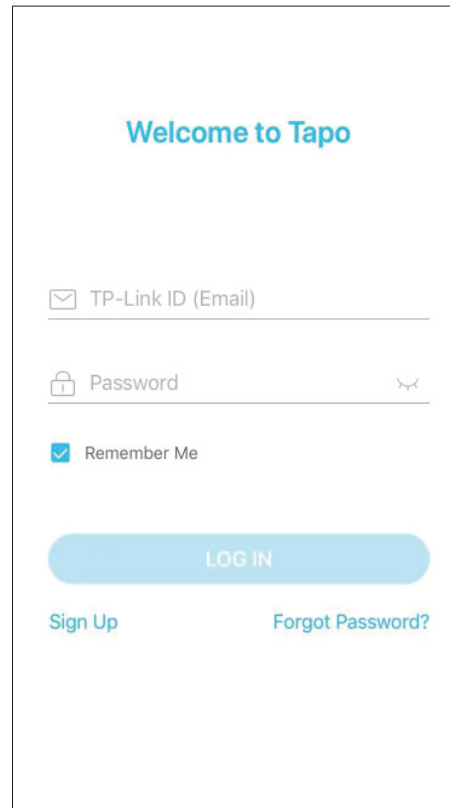

Step 3. Add Your Switch

Tap the ⊕ button in the app and select your switch. Then follow app instructions to set up your switch.

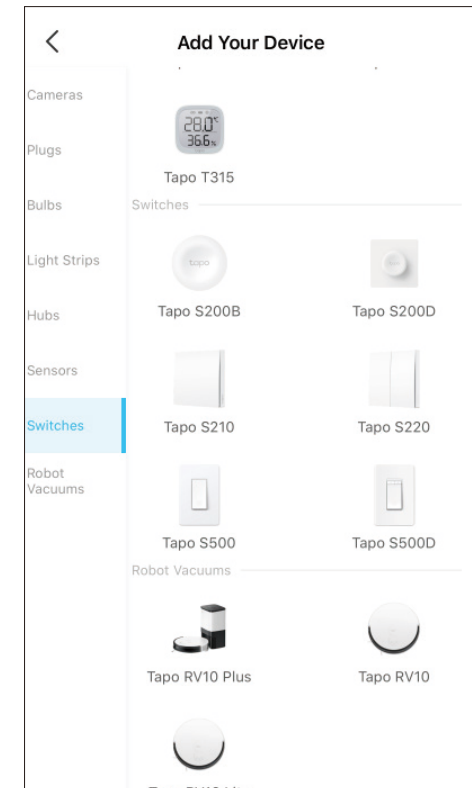

Main Device Controls

After setting up your device successful, you will see your switch listed on the home page. You can manage it from anywhere at any time with the Tapo app.

Home Page

This page lists all your devices you've added and you can view them directly and manage them easily. Tap your switch to enter the [Status](#) page.

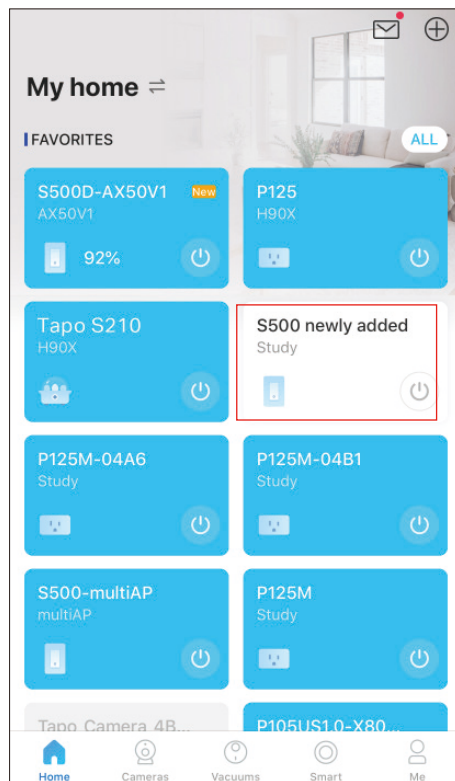

Status Page

You can turn on or off your device in this page. You can also configure advanced features like Schedule, Away Mode, Timer to control your device according to your daily routine.

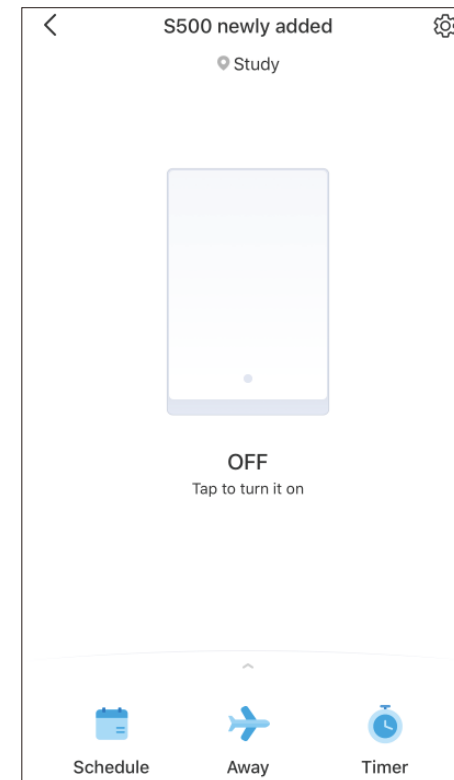

Switch Settings

On [Status](#) page, tap  to enter the [Device Settings](#) page. You can change your device name and icon, set Delayed Shut Off, etc.

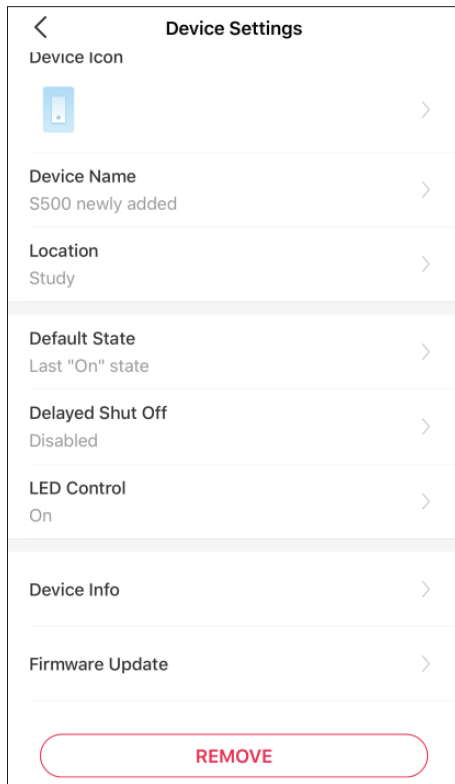

Schedule

Set schedules for your switch to automatically turn on/off at set times to simplify your daily routine.

Step 1: Go to [Status](#) page and swipe up. Tap  to set a schedule.
Schedule

Step 2: Tap  on the top right corner.

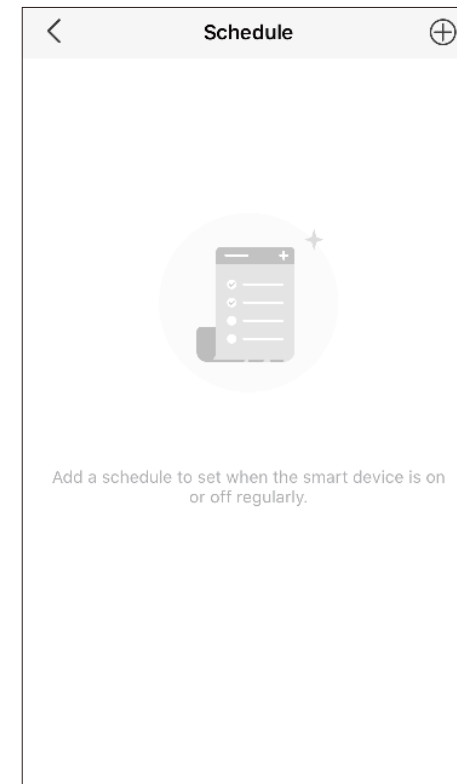
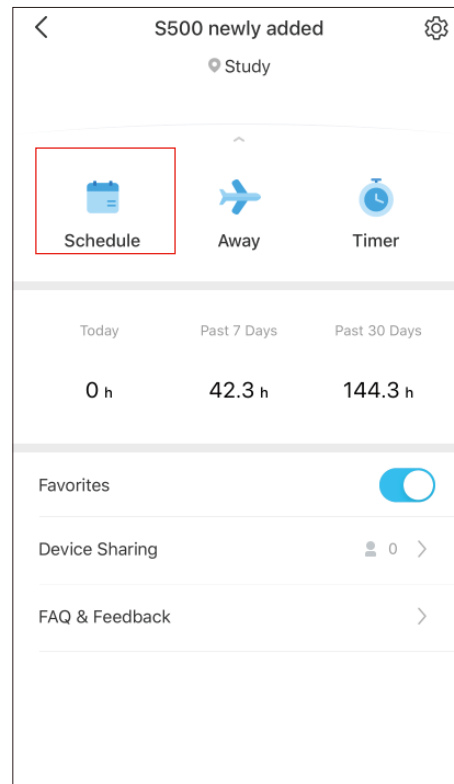
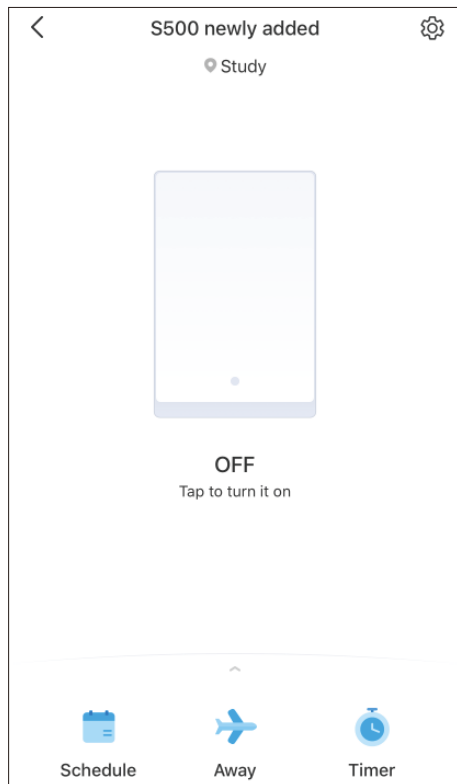

Step 3: Set the time and frequency to turn on/off your device automatically.

Done!

You can see the set schedule listed in the Schedule page.

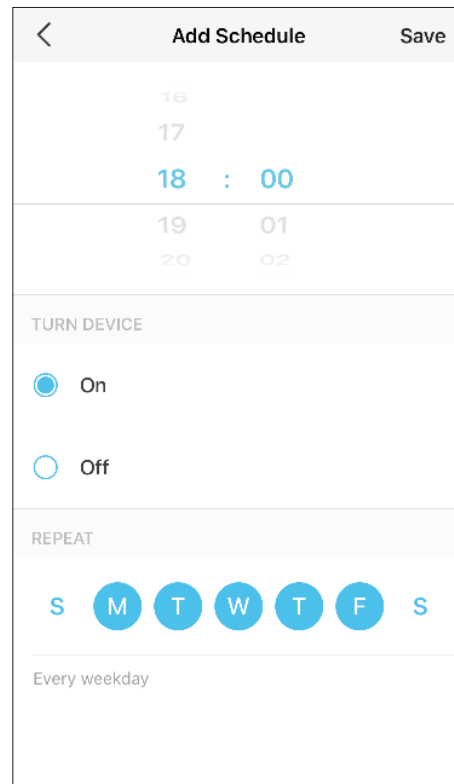
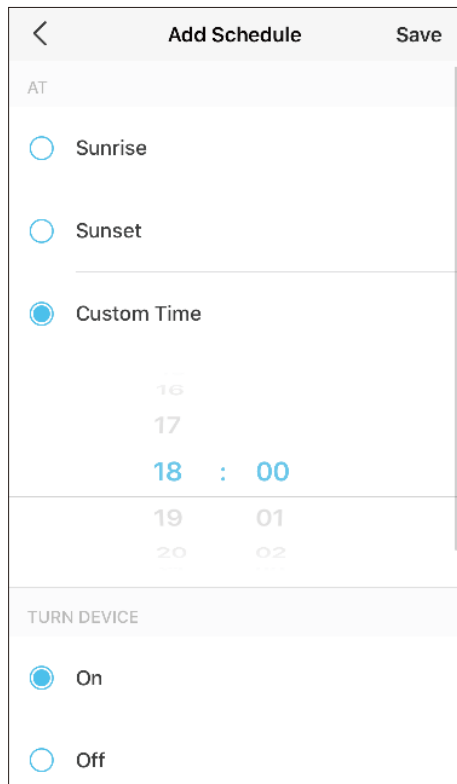

Away Mode

Set your device to turn on and off randomly during a set time period to make the appearance that someone is at home.

Step 1: Go to [Status](#) page and swipe upforward. Tap  to set Away Mode.

Step 2: Set the time period and the repeating frequency.

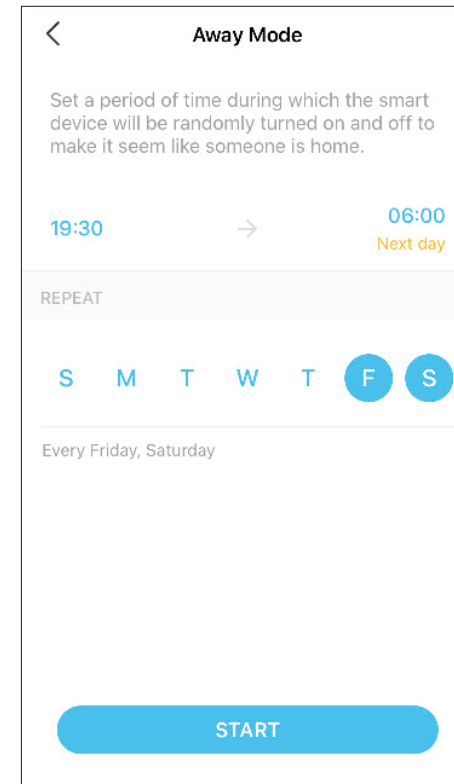
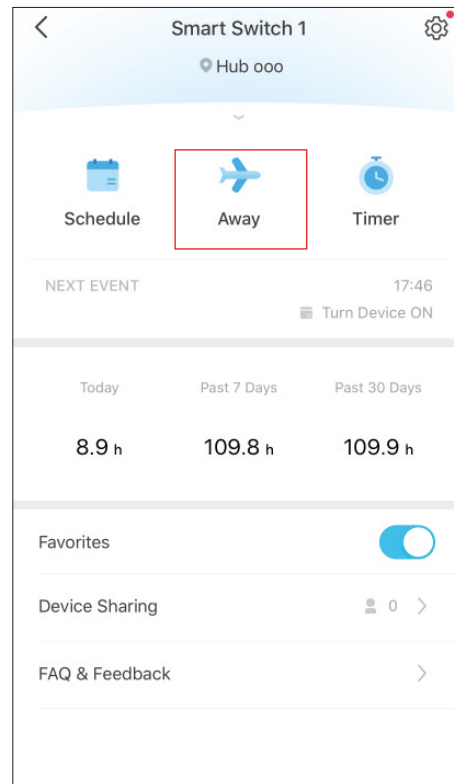
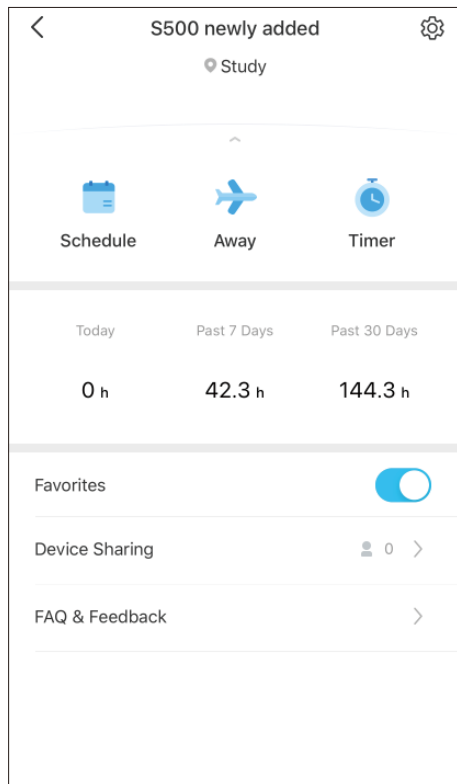

Done!

Away Mode is active. Your device will be turned on and off randomly during the time period.

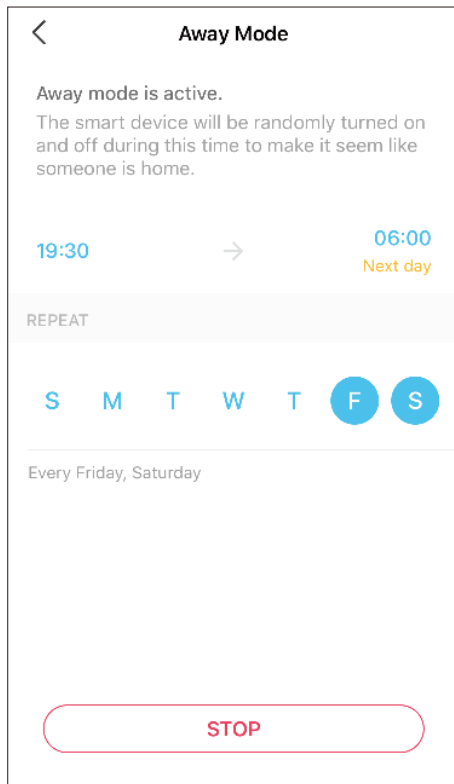

Timer

Set a countdown timer for your device to automatically turn on/off after the timer ends.

Step 1: Go to [Status](#) page and swipe upforward. Tap  to set a countdown timer.

Step 2: Set the time period and whether to turn on or off the switch after the time ends.

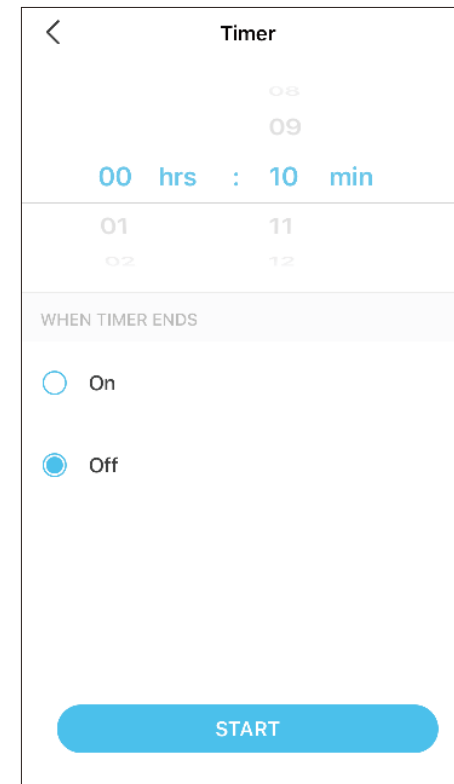
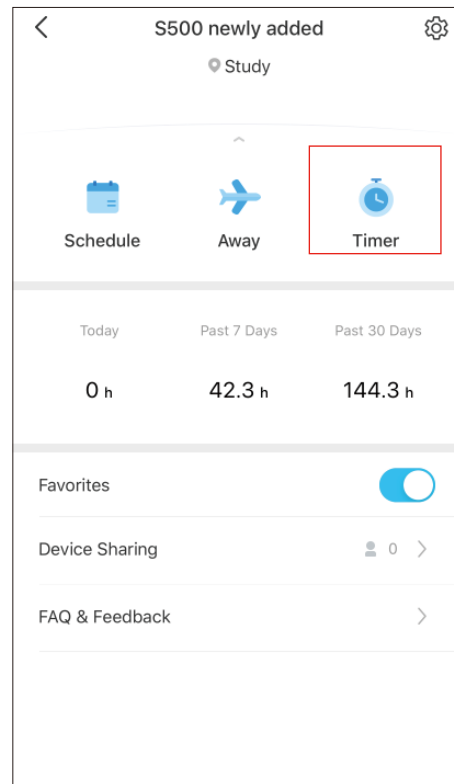
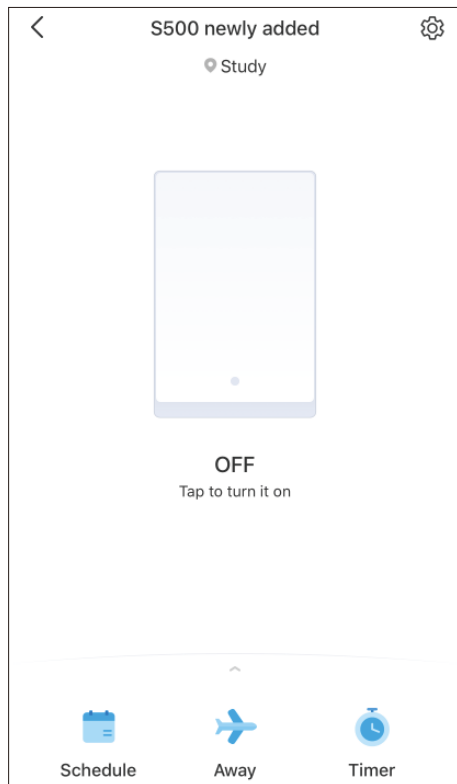

Done!

The timer is counting down. You can also see the time counting down in the Home page.

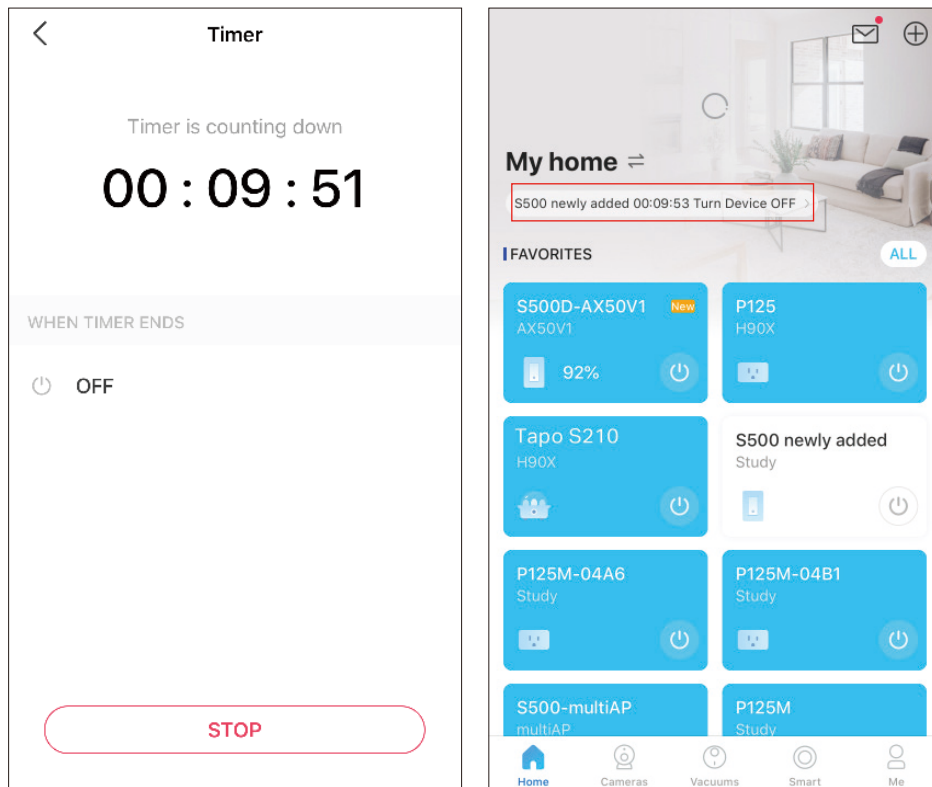

Check Runtime

Check how long the switch has been running today, for the past 7 days, or for the past 30 days.

Go to [Status](#) page and swipe upforward. You can the runtime for today, past 7 days and past 30 days.

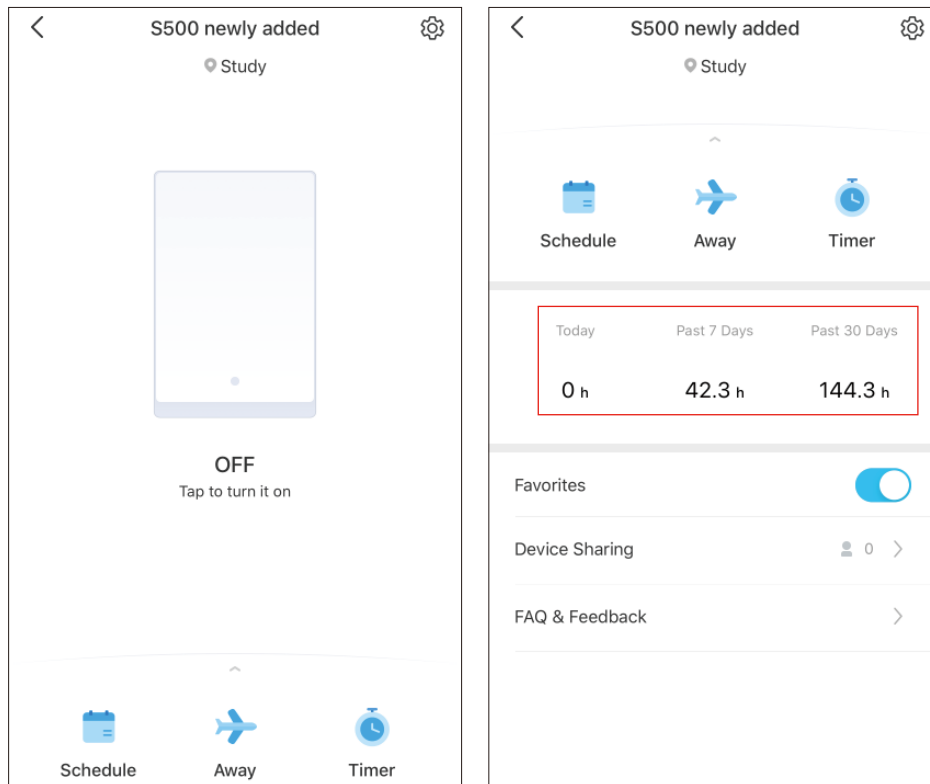

Device Sharing

Share your device to your family by entering their TP-Link ID.

Go to [Status](#) page and swipe upforward. Then tap [Device Sharing](#).

Tap [Share](#) and then enter the TP-Link ID of your family member.

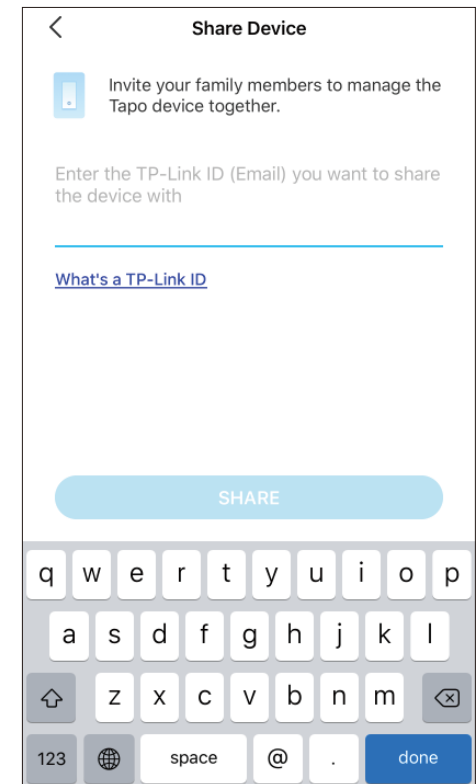
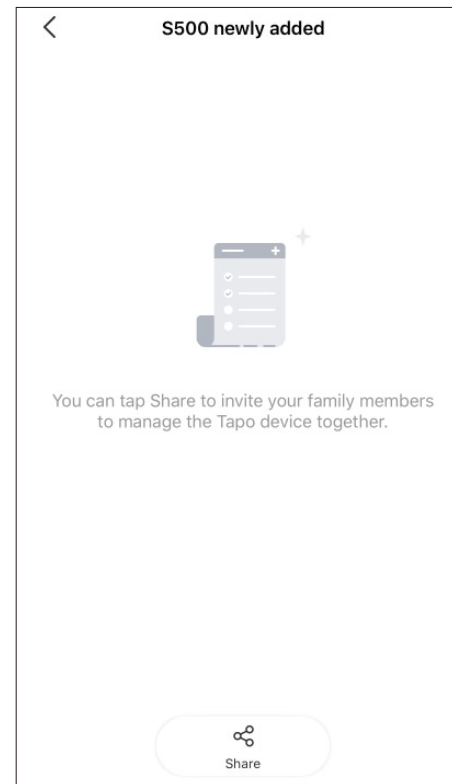
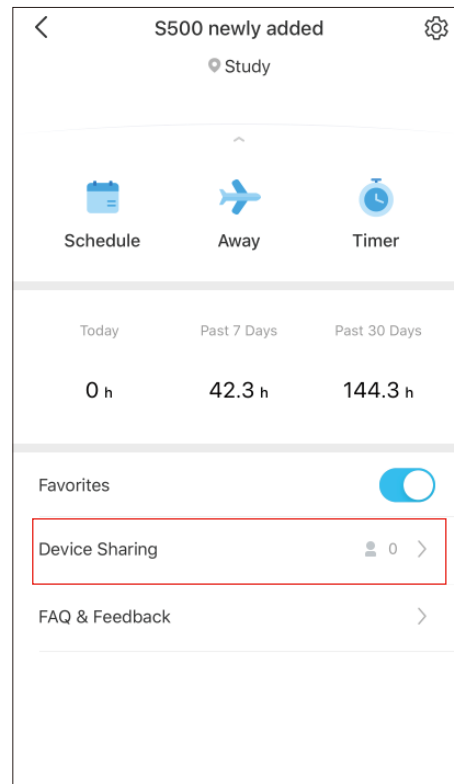
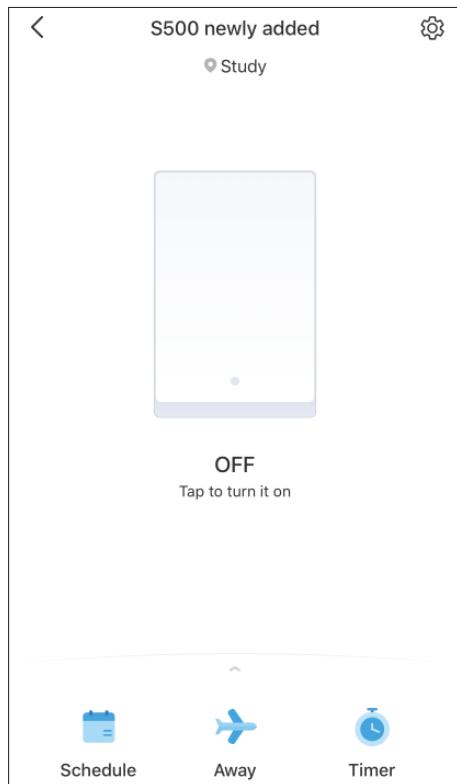

Smart Actions

Smart Actions automate repetitive tasks, allowing you to blaze through tedium with utmost ease. Set everything up once and never have to worry about it again. With Smart Actions, giving your home that level of intelligence is a snap. Shortcut lets you perform an action with a simple tap. Automation allows you to automate tasks to be performed at a set time. e.g. The light will light on at sunset.

Option 1: Edit based on the routine actions

1. Go to the [Smart Actions](#) page and you will see the [Featured Actions](#) (Shortcut or Automation).

2. Tap on a featured action. Tap [EDIT](#) to change the settings as needed and tap [APPLY](#) to save changes.

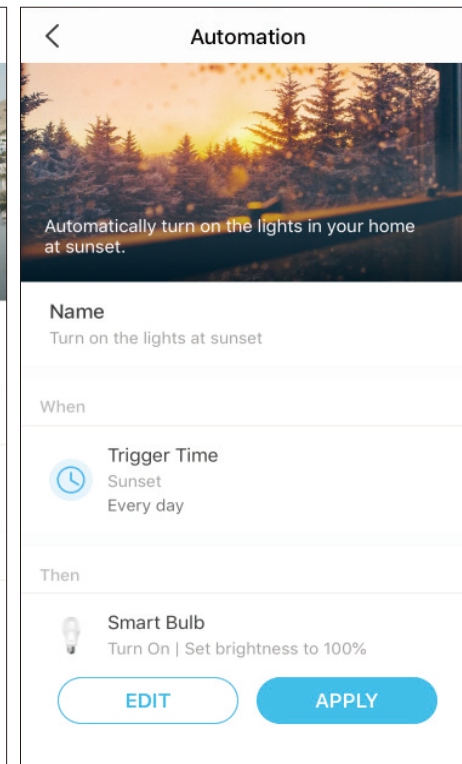
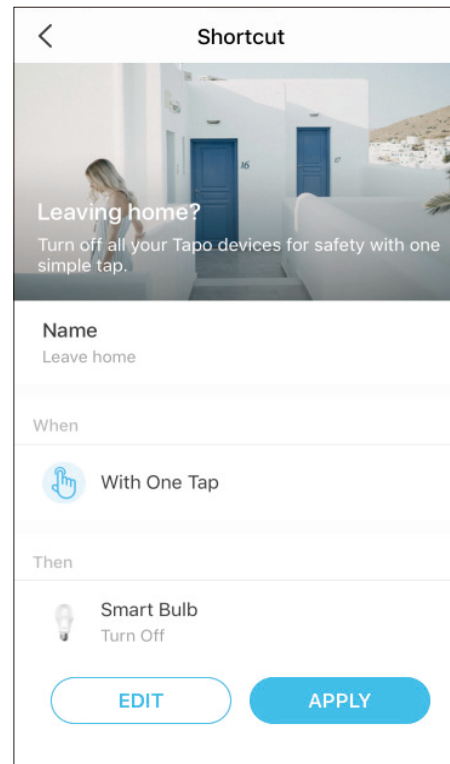
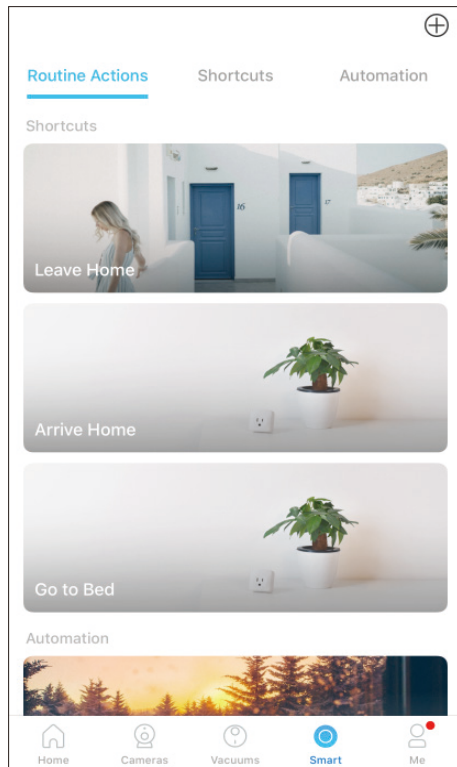

Option 2: Create your own shortcuts

1. Go to [Shortcuts](#) page. Tap + on the top right to add a shortcut.

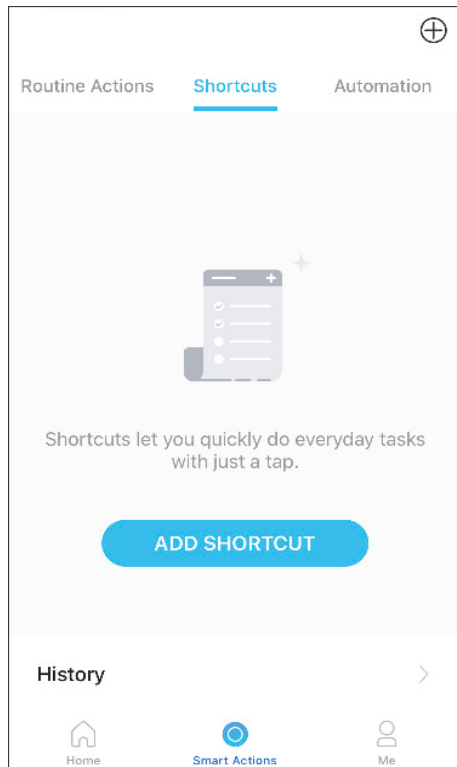

2. Add an action and choose whether to delay the action.

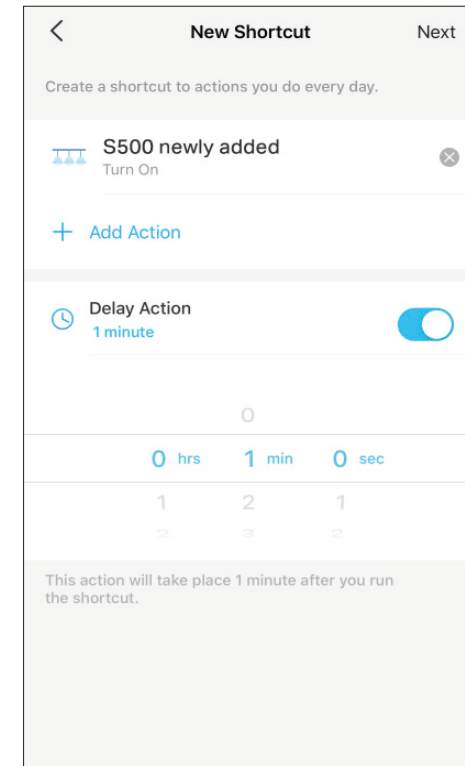
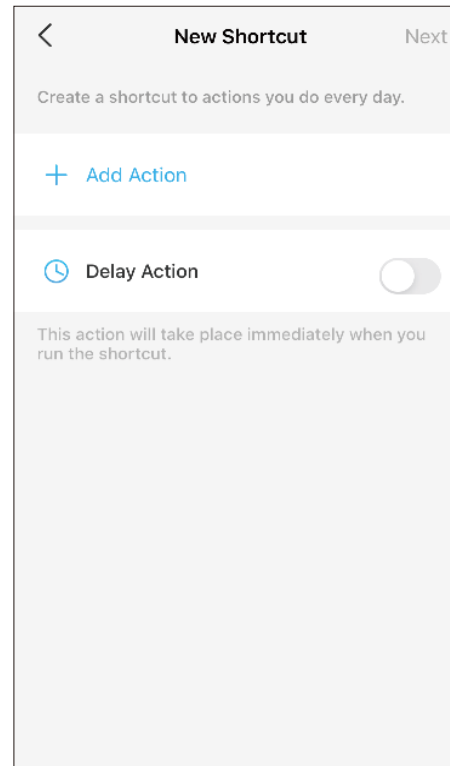

3. Name your shortcut and choose an icon and tap **Done** to save all the settings.

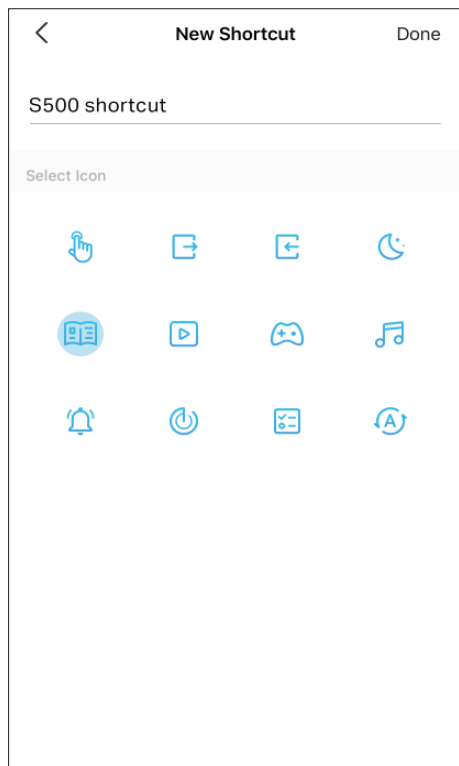

Option 3: Create your own actions

1. Go to [Automation](#) page. Tap + on the top right to add a simple and smart action.

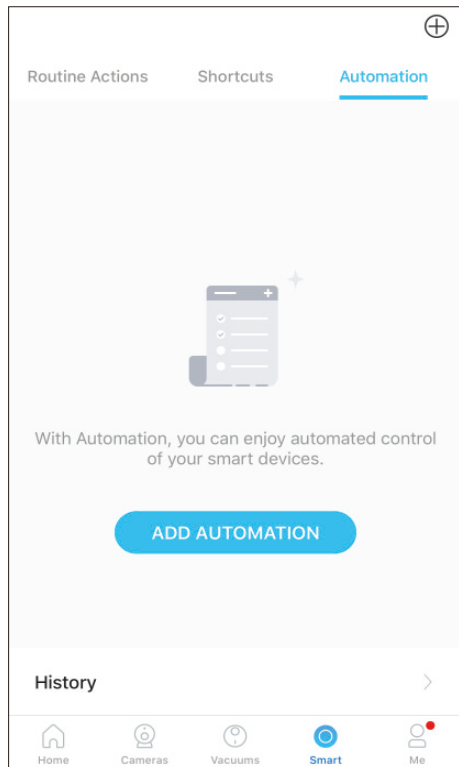

2. Name the new action. Tap + to add conditions ([When](#)) like the trigger time, and tap + to add tasks ([Then](#)) like turning on the switch.

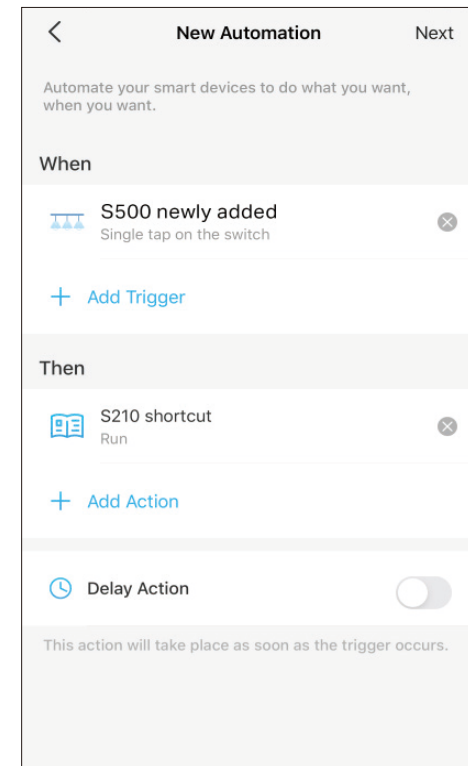
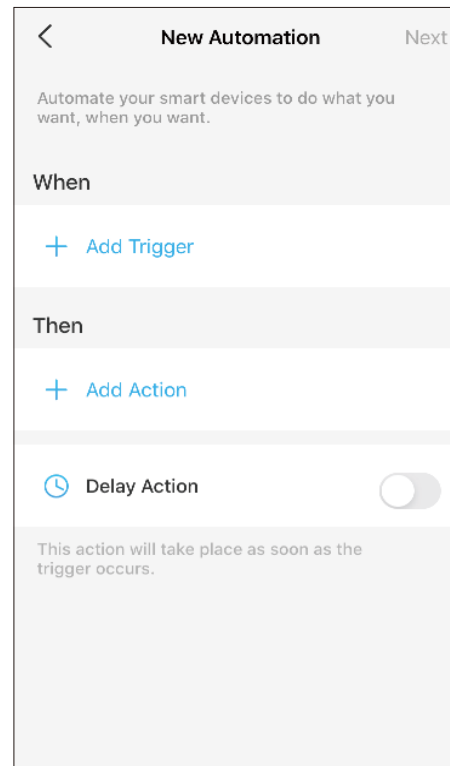

3. Name your automation and set the effective time for the automation. Tap **Done** to save all the settings.

< **New Automation** Done

Switch Control

Effective Time

Always >

Set the time for your smart actions to take effect.

Device Settings

In the Device Settings page, you can edit the basic information, set delayed shut off and double tap effect, update firmware and more.

1: Change Device name, icon and location

In the [Status](#) page, tap  to go to the Device Settings page. Then you can change the device icon, name, and its location.

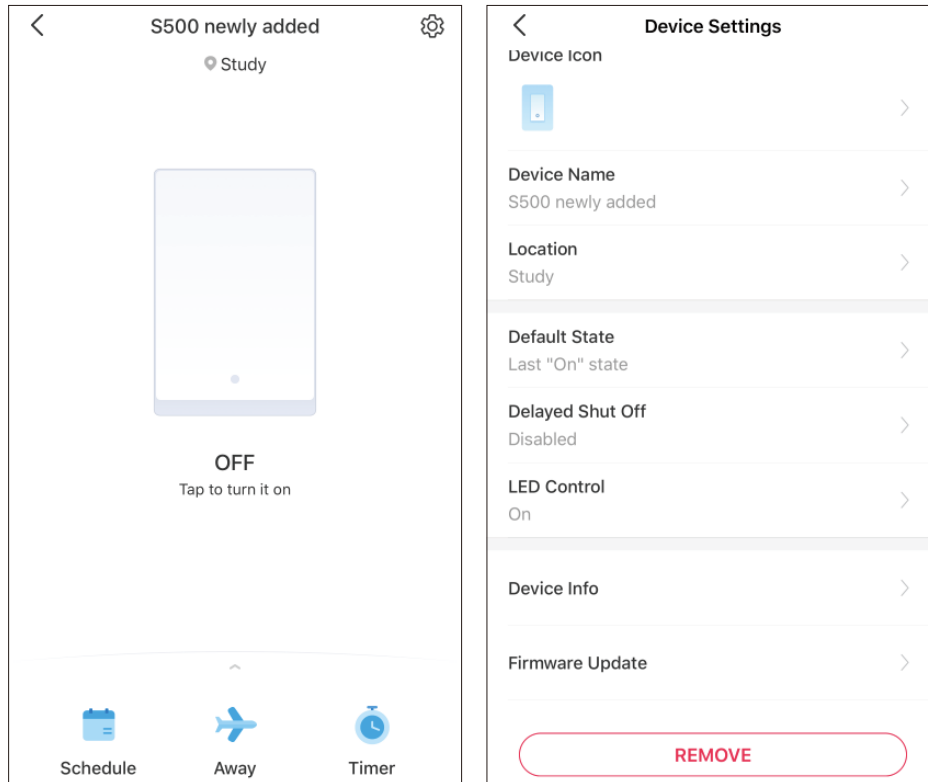

2: Set Delayed Shut Off

When Delayed Shut Off is enabled, you can press the switch to make your light remain on for a set amount of time before going off. To turn the light off instantly, press the switch once more.

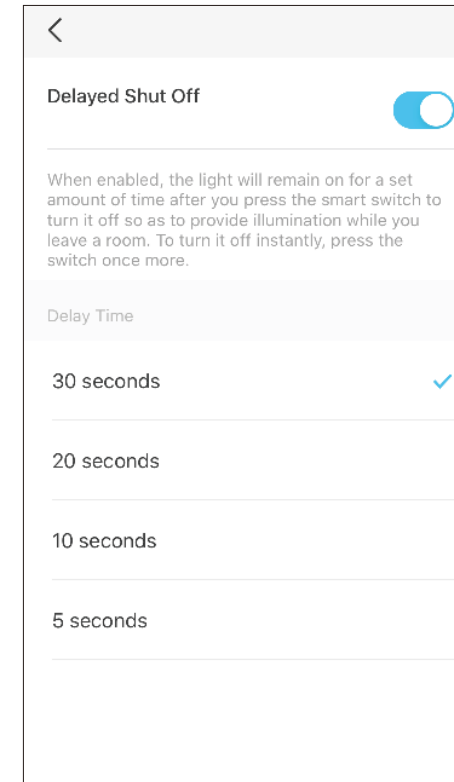

How to Reset Your Switch

There are two methods to reset your switch.

Method 1: Press the RESET button on the switch

Press and hold the **RESET** button for about 10 seconds until the LED blinks amber quickly.

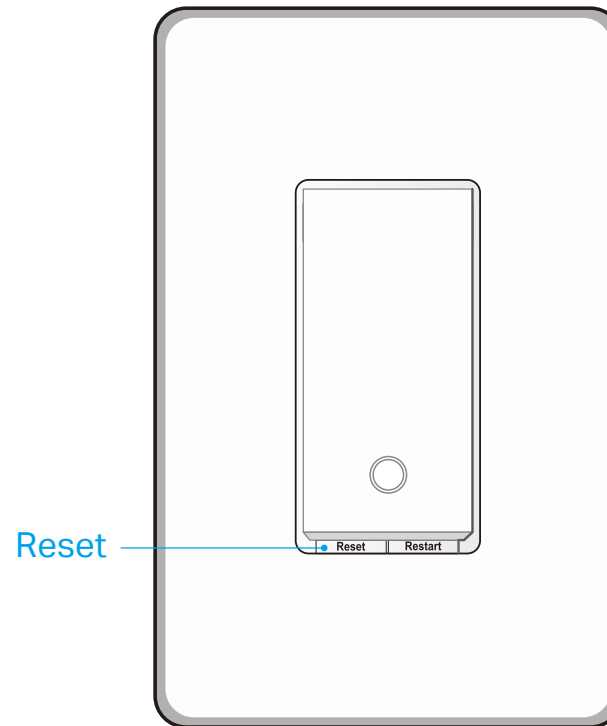

Method 2: Remove the device in the Settings page

Go to the Settings page of your switch. Tap **REMOVE** to remove your switch from Tapo.

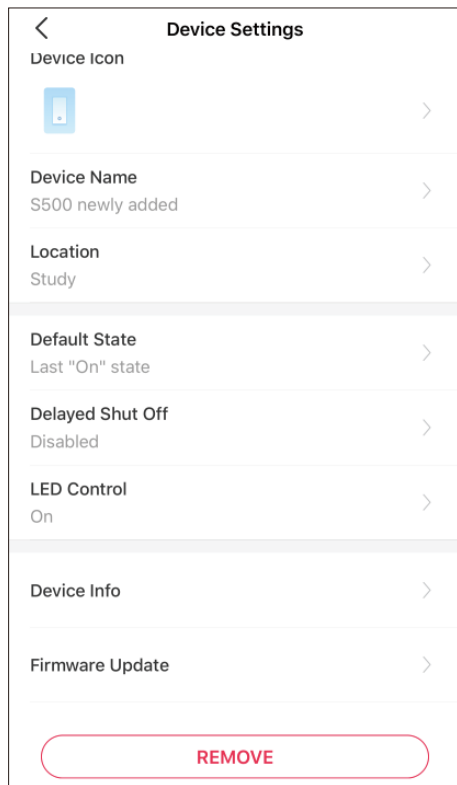

Authentication

FCC compliance information statement



Product Name: Tapo Smart Wi-Fi Light Switch, Single Pole

Model Number: Tapo S500

Responsible party:

TP-Link USA Corporation

Address: 10 Mauchly, Irvine, CA 92618

Website: <http://www.tp-link.com/us/>

Tel: +1 626 333 0234

Fax: +1 909 527 6804

E-mail: sales.usa@tp-link.com

This equipment has been tested and found to comply with the limits for a Class B digital device, pursuant to part 15 of the FCC Rules. These limits are designed to provide reasonable protection against harmful interference in a residential installation. This equipment generates, uses and can radiate radio frequency energy and, if not installed and used in accordance with the instructions, may cause harmful interference to radio communications. However, there is no guarantee that interference will not occur in a particular installation. If this equipment does cause harmful interference to radio or television reception, which can be determined by turning the equipment off and on, the user is encouraged to try to correct the interference by one or more of the following measures:

- Reorient or relocate the receiving antenna.
- Increase the separation between the equipment and receiver.
- Connect the equipment into an outlet on a circuit different from that to which the receiver is connected.
- Consult the dealer or an experienced radio/ TV technician for help.

This device complies with part 15 of the FCC Rules. Operation is subject to the following two conditions:

1. This device may not cause harmful interference.
2. This device must accept any interference received, including interference that may cause undesired operation.

Any changes or modifications not expressly approved by the party responsible for compliance could void the user's authority to operate the equipment.

Note: The manufacturer is not responsible for any radio or TV interference caused by unauthorized modifications to this equipment. Such modifications could void the user's authority to operate the equipment.

FCC RF Radiation Exposure Statement

This equipment complies with FCC RF radiation exposure limits set forth for an uncontrolled environment. This device and its antenna must not be co-located or operating in conjunction with any other antenna or transmitter.

"To comply with FCC RF exposure compliance requirements, this grant is applicable to only Mobile Configurations. The antennas used for this transmitter must be installed to provide a separation distance of at least 20 cm from all persons and must not be co-located or operating in conjunction with any other antenna or transmitter."

We, **TP-Link USA Corporation**, has determined that the equipment shown as above has been shown to comply with the applicable technical standards, FCC part 15. There is no unauthorized change is made in the equipment and the equipment is properly maintained and operated.

Issue Date: 2021.03.25

Canadian Compliance Statement

This device contains licence-exempt transmitter(s)/receiver(s) that comply with Innovation, Science and Economic Development Canada's licence-exempt RSS(s). Operation is subject to the following two conditions:

- (1) This device may not cause interference.
- (2) This device must accept any interference, including interference that may cause undesired operation of the device.

L'émetteur/récepteur exempt de licence contenu dans le présent appareil est conforme aux CNR d'Innovation, Sciences et Développement économique Canada applicables aux appareils radio exempts de licence. L'exploitation est autorisée aux deux conditions suivantes :

- 1) L'appareil ne doit pas produire de brouillage;
- 2) L'appareil doit accepter tout brouillage radioélectrique subi, même si le brouillage est susceptible d'en compromettre le fonctionnement.

Radiation Exposure Statement:

This equipment complies with IC radiation exposure limits set forth for an uncontrolled environment. This equipment should be installed and operated with minimum distance 20cm between the radiator & your body.

Déclaration d'exposition aux radiations:

Cet équipement est conforme aux limites d'exposition aux rayonnements IC établies pour un environnement non contrôlé. Cet équipement doit être installé et utilisé avec un minimum de 20 cm de distance entre la source de rayonnement et votre corps

Industry Canada Statement

CAN ICES-3 (B)/NMB-3(B)

NCC Notice

注意!

取得審驗證明之低功率射頻器材，非經核准，公司、商號或使用者均不得擅自變更頻率、加大功率或變更原設計之特性及功能。

低功率射頻器材之使用不得影響飛航安全及干擾合法通信；經發現有干擾現象時，應立即停用，並改善至無干擾時方得繼續使用。

前述合法通信，指依電信管理法規定作業之無線電通信。

低功率射頻器材須忍受合法通信或工業、科學及醫療用電波輻射性電機設備之干擾。

BSMI Notice

安全諮詢及注意事項

- 請使用原裝電源供應器或只能按照本產品注明的電源類型使用本產品。
- 清潔本產品之前請先拔掉電源線。請勿使用液體、噴霧清潔劑或濕布進行清潔。
- 注意防潮，請勿將水或其他液體潑灑到本產品上。
- 插槽與開口供通風使用，以確保本產品的操作可靠並防止過熱，請勿堵塞或覆蓋開口。
- 請勿將本產品置放於靠近熱源的地方。除非有正常的通風，否則不可放在密閉位置中。
- 不要私自拆開機殼或自行維修，如產品有故障請與原廠或代理商聯繫。

限用物質含有情況標示聲明書

設備名稱： Equipment name Kasa Smart Wi-Fi Light Switch, Single Pole		型號（型式）：Tapo S500 Type designation (Type)				
單元 Unit	限用物質及其化學符號 Restricted substances and its chemical symbols					
	鉛 Lead (Pb)	汞 Mercury (Hg)	鎘 Cadmium (Cd)	六價鉻 Hexavalent chromium (Cr+6)	多溴聯苯 Polybrominated biphenyls (PBB)	多溴二苯醚 Polybrominated diphenyl ethers (PBDE)
PCB	○	○	○	○	○	○
外殼	○	○	○	○	○	○
電源供應板	—	○	○	○	○	○
其他及其配件	—	○	○	○	○	○

備考 1. “超出 0.1 wt %” 及 “超出 0.01 wt %” 係指限用物質之百分比含量超出百分比含量基準值

Note 1: “Exceeding 0.1 wt %” and “exceeding 0.01 wt %” indicate that the percentage content of the restricted substance exceeds the reference percentage value of presence condition.

備考 2. “○” 係指該項限用物質之百分比含量未超出百分比含量基準值。

Note 2: “○” indicates that the percentage content of the restricted substance does not exceed the percentage of reference value of presence.

備考 3. “—” 係指該項限用物質為排除項目。

Note 3: The “—” indicates that the restricted substance corresponds to the exemption.

Safety Information

Before installing, servicing or removing the switch, read and follow all safety precautions including the following:

- Follow all national and local safety regulations and practices. If you are uncertain or uncomfortable when performing the installation, consult a qualified electrician.
- CAUTION – Risk of Electric Shock – More than one disconnect switch may be required to de-energize the equipment and luminaire before servicing. A circuit breaker which disconnects the Line and Neutral conductor simultaneously is suitable. Ensure power is off at the circuit breaker before removing or installing any switch. Use a non-contact voltage tester to ensure the power is off.
- Do not install the Smart Switch with wet hands or when standing on wet or damp surfaces.
- Keep the device away from water, fire, humidity or hot environments.
- Do not attempt to disassemble, repair, or modify the device. If you need service, please contact us.
- Do not use the device where wireless devices are not allowed.
- Install only in a suitable UL Listed outlet box (suitable dimensions: H > 2.95 in./75 mm, W > 1.81 in./46 mm, D > 2 in./51 mm).



CAUTION

Electronic switch integrated in this product is only intended for functional purposes. De-energized the product at the circuit breaker before servicing.

Explanation of the symbols on the product label

Symbol	Explanation
	Alternating current
	Indoor use only
	RECYCLING This product bears the selective sorting symbol for Waste electrical and electronic equipment (WEEE). This means that this product must be handled pursuant to European directive 2012/19/EU in order to be recycled or dismantled to minimize its impact on the environment. User has the choice to give his product to a competent recycling organization or to the retailer when he buys a new electrical or electronic equipment.