

gorenje

EN

GB

IE

INSTRUCTIONS FOR USE

Induction hob

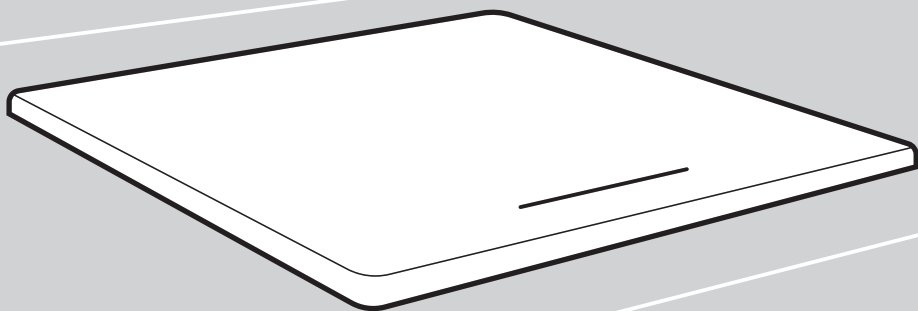

We thank you for your trust and the purchase of our appliance.

This detailed instruction manual is supplied to make the use of this product easier. The instructions should allow you to learn about your new appliance as quickly as possible.

Make sure you have received an undamaged appliance. If you do find transport damage, please contact the seller from which you purchased the appliance, or the regional warehouse from which it was supplied. The telephone number can be found on the invoice or on the delivery note.

Instructions for installation and connection are supplied on a separate sheet.

Carefully read the instructions for use before connecting the appliance. Repair or any warranty claim resulting from incorrect connection or use of the appliance shall not be covered by the warranty.



For more detailed instructions and tips, please visit <http://www.gorenje.com> or scan the QR code on the rating plate.

For more detailed instructions and tips scan the QR code on the rating plate.

The following symbols are used throughout the manual and they have the following meanings:

 **INFORMATION!**
Information, advice, tip, or recommendation

 **WARNING!**
Warning – general danger

Contents

1. Safety precautions	5
2. Other important safety warnings	7
2.1 Before connecting the appliance	7
3. Induction hob installation	8
3.1 Flush-mount installation into the worktop	10
4. Connecting the induction hob to the power mains	14
4.1 Power cord	14
4.2 Connecting the appliance	15
5. Appliance description	18
5.1 Before first use	18
6. Operating the cooking hob	19
6.1 Control unit	19
6.2 Switching the hob on/off	21
6.3 Automatic pan detection	21
6.4 Pan movement detection	22
6.5 Switching the cooking zone on/off	22
6.6 High heating setting - "Power boost"	23
6.7 Automatic heating	23
6.8 Bridged cooking zone - "Bridge"	24
6.9 Pause - "Stop&Go"	24
6.10 Memory function - "Recall function"	25
6.11 Pan detection indicator	25
6.12 Hot cooking zone indicator	26
6.13 Time functions	26
6.14 User settings	27
6.15 Child lock	29
6.16 The additional functions with automatic programs	29
6.17 Maximum cooking time	31
6.18 Automatic overheat protection	31
6.19 Automatic switch off	31
6.20 ConnectLife	32
6.21 Wi-Fi management	32
6.22 Connecting an external hood - "Hob to Hood"	33
7. Tips and hints	34
7.1 Cooking hob (conventional or glass ceramic)	34
7.2 Induction cooking zone operating principle	34
7.3 Induction cookware	35
7.4 Energy saving tips	36
8. Cleaning and maintenance	37
9. Problems and errors	38
9.1 Noises during induction cooking	40
10. Technical data	40
11. Disposal	41

1. Safety precautions

IMPORTANT SAFETY PRECAUTIONS – CAREFULLY READ THE INSTRUCTIONS AND SAVE THEM FOR FUTURE REFERENCE.

This appliance can be used by children aged from 8 years and above and persons with reduced physical, sensory or mental capabilities or lack of experience and knowledge if they have been given supervision or instruction concerning use of the appliance in a safe way and understand the hazards involved. Children shall not play with the appliance. Cleaning and user maintenance shall not be made by children without supervision.

WARNING: The appliance and its accessible parts become hot during use. Care should be taken to avoid touching heating elements.

Children less than 8 years of age shall be kept away unless continuously supervised.

Do not use steam cleaners or high-pressure cleaners to clean the appliance, as this may result in an electric shock.

The appliance is not intended to be controlled by external timers or separate remote control system.

Appliance must be connected to fixed wiring which has incorporated means of disconnection. Fixed wiring must be made in accordance with the wiring rules.

If the supply cord is damaged, it must be replaced by the manufacturer, its service agent or similarly qualified persons in order to avoid a hazard (only for appliances supplied with connection cord).

WARNING: If the surface is cracked, switch off the appliance to avoid the possibility of electric shock. Switch off all cooking zones using their respective controls and remove the fuse or trip the main circuit breaker so that the appliance is fully isolated from the power mains.

WARNING: Unattended cooking on a hob with fat or oil can be dangerous and may result in fire. NEVER try to extinguish a fire with water, but switch off the appliance and then cover flame e.g. with a lid or a fire proof blanket.

WARNING: Danger of fire: do not store items on the cooking surfaces.

CAUTION: The cooking process has to be supervised. A short term cooking process has to be supervised continuously.

CAUTION: This appliance is for cooking purposes only. It must not be used for other purposes, for example room heating.

WARNING: Use only hob guards designed by the manufacturer of the cooking appliance or indicated by the manufacturer of the appliance in the instructions for use as suitable or hob guards incorporated in the appliance. The use of inappropriate guards can cause accidents.

Metalic objects such as knives, forks, spoons and lids should not be placed on the hob surface since they can get hot.

After use, switch off the hob element by its control and do not rely on the pan detector.

The appliance may only be connected to the power mains by an authorized service technician or expert. Tampering with the appliance or nonprofessional repair thereof may result in risk of severe injury or damage to the product.

2. Other important safety warnings

The appliance is intended for household use. Do not use it for any other purpose, such as room heating, drying of pets or other animals, paper, fabrics, herbs etc. As this may lead to injury or fire hazard.

The appliance may only be connected to the power mains by an authorized service technician or expert. Tampering with the appliance or nonprofessional repair thereof may result in risk of severe injury or damage to the product.

If another electrical appliance is connected to an AC power socket near the appliance, make sure the power cord does not come in to contact with hot cooking zones.

If the power cord is damaged, it should be replaced by the manufacturer or an authorised service technician, in order to avoid hazard.

Using the glass ceramic hob as a storage area may result in scratches or other damage to it. Never heat food in aluminium foil or in plastic containers on the cooking hob. Such foil or containers may melt which can result in a fire or damage to the cooking hob.

Do not store temperature-sensitive items underneath the appliance, such as cleaners or detergents, spray cans etc.

Eventual mismatches in colour shades between different appliances or components within a single design line may occur due to various factors, such as different angles under which the appliances are observed, different coloured backgrounds, materials, and room illumination.

2.1 Before connecting the appliance



WARNING!

Carefully read the instructions for use before connecting the appliance. Repair or any warranty claim resulting from incorrect connection or use of the appliance shall not be covered by the warranty.

3. Induction hob installation

Installation dimensions

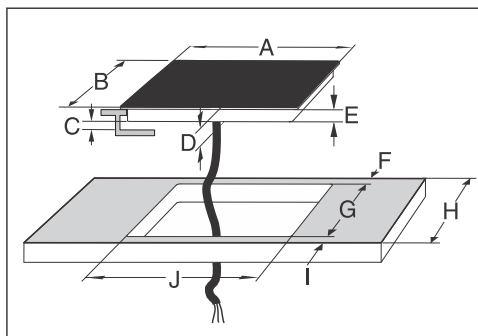

	A	B	C	D	E	F	G	H	I	J
60 cm	595	520	min.10	54	50	min.40	490-492	min.600	min.50	560-562
80 cm	795	520	min.10	54	50	min.40	490-492	min.600	min.50	760-762



INFORMATION!

Installation and connection of the appliance to the power mains may only be carried out by a qualified technician.

Installation procedure

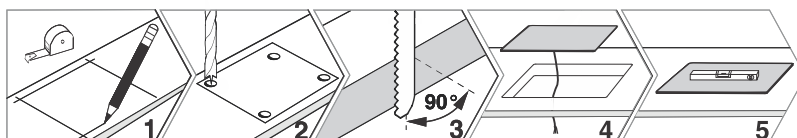

- Suitably protect the edges of the cut aperture.
- Connect the induction cooking hob to the mains power supply (see instructions for the connection of the induction cooking hob to mains power supply).
- Place the induction hob into the cut aperture.
- Veneer or other finish of the piece of kitchen furniture into which the hob is to be built in should be treated with heat resistant glue (100 °C); otherwise, the worktop finish may be discolored or deformed.
- Use of solid wood corner trims on worktops behind the induction cooking hob is only allowed if the clearance between the trim and the hob is no smaller than indicated on the installation plans.



INFORMATION!

The worktop has to be completely level.



INFORMATION!

The appliance already has a pre-installed gasket.

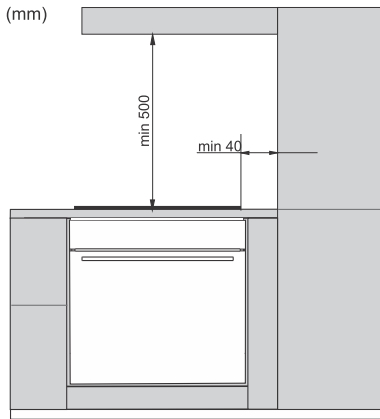

- The induction hob is suitable for installation into a worktop above a kitchen cabinet with a minimum width of 600 mm.
- Any kitchen cabinetry suspended above the induction hob should be high enough not to disturb the work process.
- The vertical distance between the induction hob and the kitchen hood must be at least the distance specified in the instructions for installation of the kitchen hood and no less than 500 mm.
- The distance between the edge of the induction hob and the adjacent kitchen cabinet should be no less than 40 mm.
- Minimum clearance between the induction hob and the rear wall is indicated in the installation diagram.

Lower cabinet with a drawer

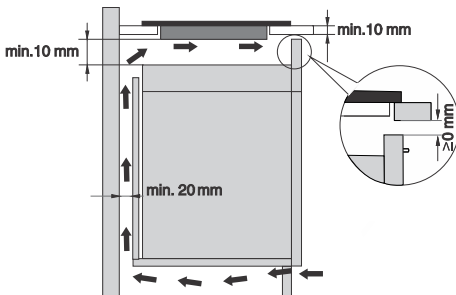

- There must be an opening with a height of no less than 140 mm along the entire width of the cabinet in the cabinet rear wall.
- Adequate ventilation should be allowed.
- There must be a drawer under the kitchen cabinet. Do not store aluminium foil, flammable substances or liquids (such as sprays) in it. Keep such substances away from the cooking hob. Danger of explosion! It should also not be used to store small objects and paper, as they may be sucked in.

Lower cabinet with an oven

- Installing an oven under the induction hob is possible for oven models with a cooling fan.
- Before installing the oven, the kitchen cabinet rear wall has to be removed in the area of the opening for installation.
- If other appliances are installed under the induction cooking hob we cannot guarantee their correct operation.

💡 INFORMATION!
Normal operation of the induction cooking hob electronic components requires sufficient air circulation.

💡 INFORMATION!
The recommended height of the front ventilation slot is 4 mm.

3.1 Flush-mount installation into the worktop

Installation dimensions

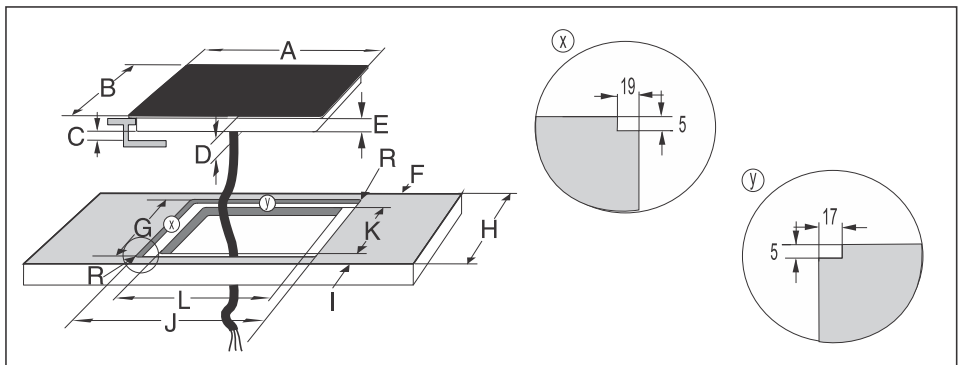

	A	B	C	D	E	F	G	H	I	J	K	L
60 cm	595	520	min.10	54	50	min.40	524-525	min.600	min.50	599-600	490-492	560-562
80 cm	795	520	min.10	54	50	min.40	524-525	min.600	min.50	799-800	490-492	760-762

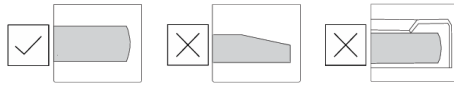

Appliances without faceted edges or decorative frames, are suitable for flush mounting.

GLASS	CUT-OUT

Installation procedure

- The appliance may only be installed into a temperature- and water-resistant countertop, such as a countertop made of natural stone (marble, granite) or solid wood (the edges along the cut-out have to be sealed).
- When installing into a countertop made of ceramics, wood, or glass, a wooden sub-frame should be used. The frame is not supplied with the appliance. The appliance may only be installed into a countertop made of other materials after you have consulted the countertop manufacturer and obtained his express approval.
- Internal dimension of the basic unit should be at least equal to the internal cut-out for the appliance. This will allow simple removal of the appliance from the countertop.

	1. First, feed the power cord through the cut-out.
	2. Place the appliance over the centre of the cut-out.
	3. Connect the appliance to the power mains.
	4. Test appliance operation.
	5. Seal the slot between the appliance and the countertop using a silicone sealant. The silicone sealant used to seal the appliance has to be temperature-resistant (to at least 160 °C).
	6. Smooth out the silicone sealant using a suitable tool. Do not switch on the appliance until the silicone sealant has dried completely.

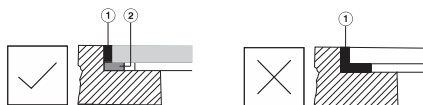

1. Silicone sealant
2. Sealing tape

Stone countertop



WARNING!

Pay particular attention to built-in dimensions with (natural) stone countertops. When choosing the silicone sealant, observe the countertop material and consult the countertop manufacturer. Use of inappropriate silicone sealants can result in permanent discolouration of some parts.

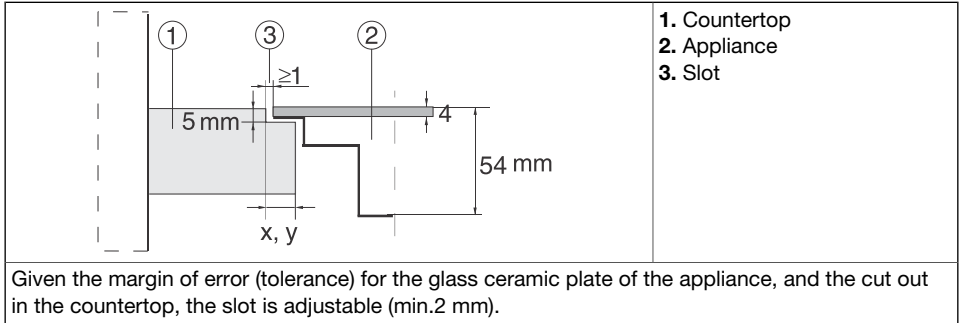

Ceramic, wooden, or glass countertop

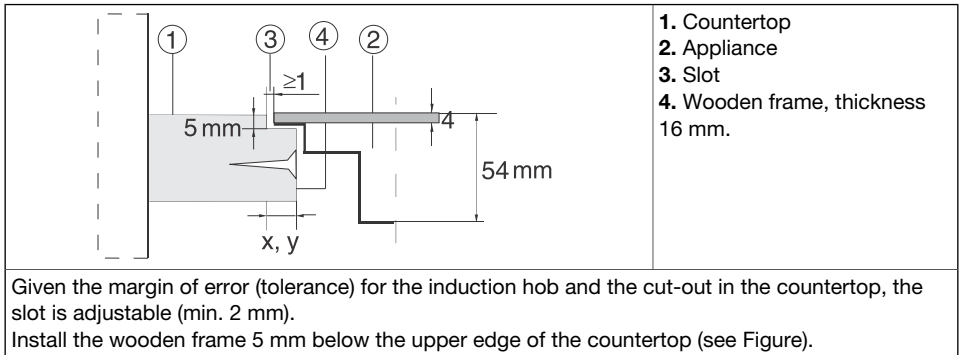

Removing the built-in appliance

Disconnect the induction hob from the power mains. Use a suitable tool to remove the silicone gasket from the perimeter. Remove the induction hob by pressing from the lower side upwards.



WARNING!

Do not attempt to remove the appliance from the upper side of countertop!



WARNING!

The service department shall only be responsible for repair and servicing of the induction hob. Consult your specialized kitchen equipment dealer regarding the re-installation of the flush-mount induction hob.

**WARNING!**

If the oven is installed under a flush-mounted cooking hob, then the worktop thickness should be at least 40 mm.

4. Connecting the induction hob to the power mains

- Power mains protection must conform to the relevant regulations.
- Before connecting the appliance, make sure the voltage specified on the rating plate conforms to the voltage of the power mains.
- There should be a switching device in the electrical installation that can disconnect all poles of the appliance from the power mains, with a minimum clearance of 3 mm between the contacts when open. Suitable devices include fuses, protective switches etc.
- The connection should be adjusted to the current and fuses.
- After installation, the parts carrying electrical current and insulated parts shall be protected against contact.



WARNING!

The appliance may only be connected by an authorised expert. Incorrect connection may damage parts of the appliance. In such case, there is no right to warranty! Disconnect the appliance from the power mains before any repair or maintenance operation.



WARNING!

The appliance can be connected to the power mains when the temperature of the appliance is that of room temperature.

4.1 Power cord

(appliance without a power cord)

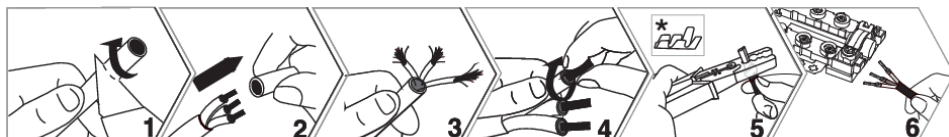

* Ferrules are not supplied.



INFORMATION!

We recommend using electric wire ferrules (end terminals).

- The following may be used for connection:
- PVC insulated connection cables type H05 VV-F with yellow-green protective conductor, or other equivalent or superior cables.
- Exterior cable diameter should be at least 8.00 mm.
- Run the power cord through a cord strain relief (clamp) that protects the cable from being pulled out.

4.2 Connecting the appliance

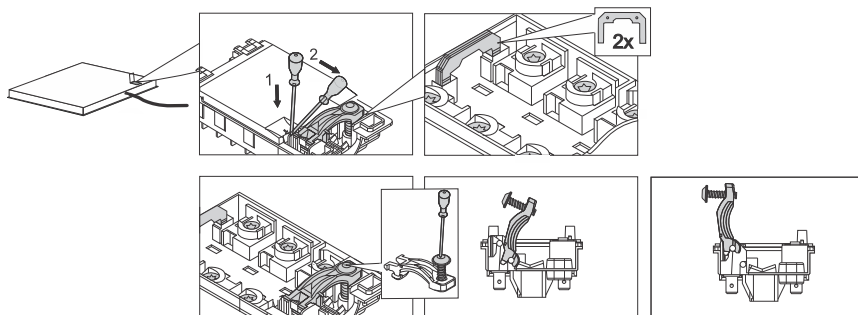

1. Open the cover of the connection terminal box.
2. Connect everything according to your type of appliance. The jumpers are provided on the connection terminal.
3. Run the power cord through a cord strain relief (clamp) that protects the cable from being pulled out.
4. For smaller diameter cables, remove the cord strain relief from the terminal and place it at a lower position as shown in the figure below.

Terminal

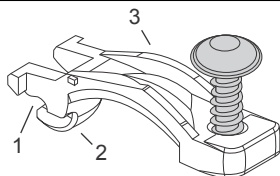

1. Higher position (cables of larger diameters)
2. Lower position (cables of smaller diameters)
3. Cord strain relief

To remove the cord strain relief from a higher position, unscrew it first with a screwdriver, place it in a vertical position and pull it out of the bracket with some force in the direction of the arrow.

To attach the cable holder to a lower position, first place it in a vertical position, then attach it to the bracket using vertical force.

Connection diagram

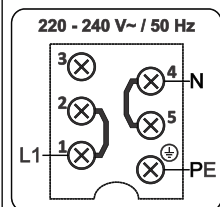

Single phase connection (up to 32 A)

- Single-phase connection (1 1N, 220-240 V~/50 Hz):
 - Voltage between line and neutral conductor is 220–240 V~. Install a jumper between terminals 1 and 2, and between terminals 4 and 5.
 - The circuit should be fitted with a fuse of up to 32 A. Power cord core cross-sectional area should be at least 4 mm².
 - If fuse is lower than 32 A, max current can be reduced in user settings (see chapter Maximum power setting - "Power management").

Connection diagram	
<p>380 - 415 V 2N~ / 50 Hz</p>	<p>2-phase connection (16A)</p> <ul style="list-style-type: none"> • 2 phases, 1 neutral conductor (2 1N, 380–415 V~ /50 Hz): <ul style="list-style-type: none"> - Voltage between the line and neutral conductor is 220–240 V~.; voltage between lines is 380–415 V~. Install a jumper between the terminals 4 and 5. The circuit should be fitted with at least two fuses of at least 16 A each. Power cord core cross-sectional area should be at least 1.5 mm².
<p>220 - 240 V 2-2N~ / 50 Hz</p>	<p>2-phase connection with two neutral conductors (16A)</p> <ul style="list-style-type: none"> • 2 phases, 2 neutral conductors (2 2N, 220–240 V 2 2N ~ /50 Hz): <ul style="list-style-type: none"> - Voltage between phases and neutral conductor is 220-240 V~. - The circuit should be fitted with at least two fuses of at least 16 A each. Power cord core cross-sectional area should be at least 1.5 mm².

Connecting the power cord to the power mains

(appliance with a power cord)

- The cooking hob has to be hard-wired directly to the power mains.
- Devices for disconnecting from the power mains have to comply with the relevant regulations.
- Do not extend the power cord and do not lead it over sharp edges.
- If the appliance is installed above an oven, make sure the power cord is never in contact with the oven's hot parts.

Single-phase connection	Two-phase connection		
<p>1x < 32A 220-240 V 50Hz</p> <p>A</p>	<p>2N 2 x 16 A 380-415 V 50Hz</p> <p>B</p>	<p>2 2N 2 x 16 A 220-240 V 50Hz</p> <p>C</p>	<p>L, L1 = brown L2 = black N, N1 = grey ⊕ = yellow and green</p>

Single-phase connection	Two-phase connection	
<p>If your electric mains have 1 phase and 1 neutral conductor, connect the appliance as shown in Figure A.</p>	<p>If your electric mains have 2 line conductors and 1 neutral conductor, connect the appliance as shown in Diagram B.</p>	<p>If your electric mains have 2 line conductors and 2 neutral conductors, connect the appliance as shown in Diagram C.</p>

Maximum power setting - "Power management"



After connecting the appliance to the power mains, press the following key for 3 seconds . As you hold down the key, a short audible signal sounds twice. The following menu will open P_{0U} . By pressing the key, you enter the additional menu, where you can use the < or > keys to select the maximum power of the appliance. The first number represents the number of connection phases, and the second and third numbers represent the current value per phase. To save the settings, press and hold for 3 seconds or press if you do not want to save the settings. Two minutes after connecting the appliance to the power mains, the power settings can no longer be changed.



INFORMATION!

If the cooking zone power settings exceed the maximum allowed power, the user interface automatically lowers the power to the maximum allowed power.

Number of phases	Current [A]	Total power [W]	Number and cross-section of power cable wires
1	32	7360	3 x 4.0 mm ²
1	16	3680	3 x 4.0 mm ²
1	13	2990	3 x 4.0 mm ²
1	12	2760	3 x 4.0 mm ²
1	10	2300	3 x 4.0 mm ²
2	16	7360	4 x 1.5 mm ² or 5 x 1.5 mm ² (only for NL)
2	13	5980	4 x 1.5 mm ²
2	12	5520	4 x 1.5 mm ²
2	10	4600	4 x 1.5 mm ²



INFORMATION!

The maximum allowed power depends on the model.

5. Appliance description



INFORMATION!

Appliance functions and equipment depend on the model.

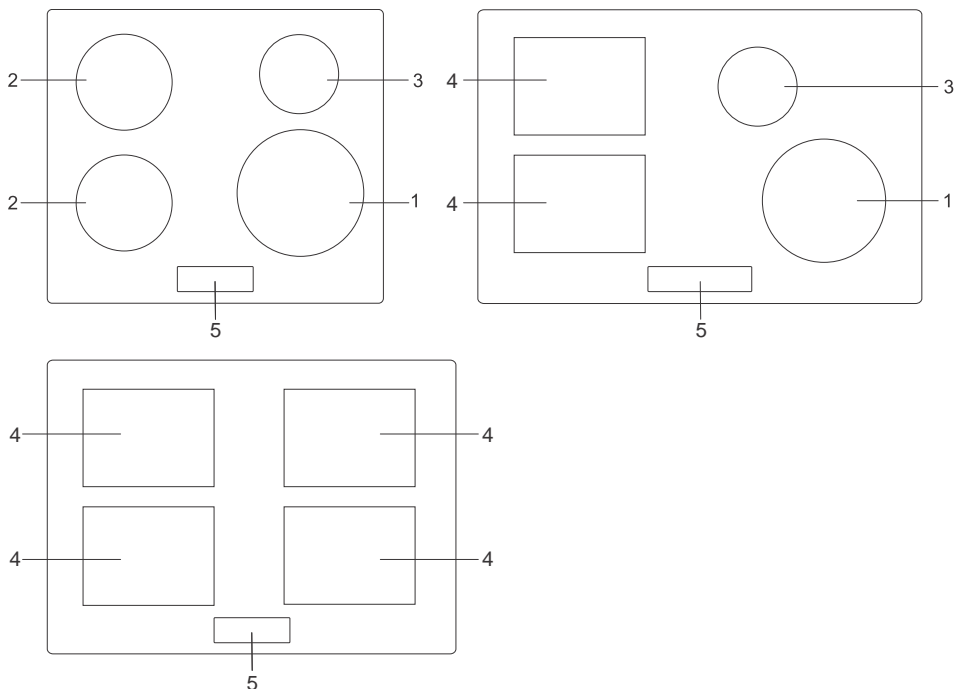

1. Induction cooking zone \varnothing 230 mm - 2300W - 3000W (boost)
2. Induction cooking zone \varnothing 180 mm - 1400W - 2100W (boost)
3. Induction cooking zone \varnothing 145 mm - 1200W - 1800W (boost)
4. Bridge induction cooking zone 210 x 180 mm - 2300W - 3000W (boost)
5. Cooking hob control module

5.1 Before first use

Clean the cooking surface using a damp cloth and some mild washing-up liquid.

During initial use, the characteristic "new appliance smell" may appear; it will gradually disappear.

6. Operating the cooking hob

6.1 Control unit





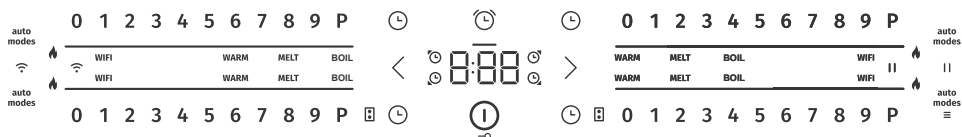



(depending on the model)





The appliance can have 3 or 4 sliders.



Key/Display	Description
	<p>Switching the hob on/off</p> <p>The key can be used to turn the appliance on or off.</p>
	<p>Lock/child lock</p> <p>The appliance can be locked and unlocked to prevent it from being switched on unintentionally. Press and hold it for 3 seconds. The appliance is now locked.</p>
	<p>Time functions</p> <ul style="list-style-type: none"> countdown timer for the entire cooking hob; does not power off the cooking zone.
	<ul style="list-style-type: none"> shut-off timer for respective cooking zones; when the time expires, the cooking zone is powered off.
	<p>Increase time settings</p> <ul style="list-style-type: none"> Touch the key to increase the timer or program timer settings by 1 minute. Long press to quickly increase the timer or program timer settings to the desired value.
	<p>Decrease time settings</p> <ul style="list-style-type: none"> Touch the key to decrease the timer or program timer settings by 1 minute. Long press to quickly decrease the timer or program timer settings to the desired value.
	<p>User settings</p> <p>Touch the key for 3 seconds to turn on the user settings, where you can adjust the volume, brightness, automatic pan detection, child lock and alarm duration, pair the external hood or restore the user settings to the factory settings. Access is only possible when the hob is turned off.</p>
auto modes	<p>Extra functions</p> <p>Touch the key to activate additional hob settings: reheating, defrosting and boiling.</p>

Table continued from last page

Key/Display	Description
	Wi-Fi connectivity settings (depending on the model) When the user interface is on and the cooking zones are off, hold down the key and release it when you want to enter the menu displayed on the timer.
	Pause With this function, you can pause the operation of the entire hob for up to 10 minutes. In the meantime, you can safely clean the hob without losing your settings. Press the key to turn on or off the cooking pause and turn it on again.
WARM	Keep warm/reheat This function allows you to keep warm and reheat ready-made dishes.
MELT	Melting/defrosting The function allows you to gently melt foods such as chocolate or butter. It also allows defrosting of frozen food.
BOIL	Bringing to the boil / boiling in water This function automatically brings water to the boil and then keeps it boiling.
	Bridge (depending on the model) Combine the cooking zones by pressing this key.
	Timer related to the cooking zone The symbol lights up when you select the corresponding timer connected to the cooking zone.
	Timer related to the entire hob The symbol lights up when you select the countdown timer for the entire cooking hob.
	Timer settings display Display the time settings.
	Slider Touch or slide the slider to set the cooking power or switch off the cooking zone.
	Power level display When the FLUE function is not on, the cooking zone display is partially illuminated. When the value is selected, it will illuminate fully.
	Hot zone indicator The cooking hob has an indicator light for each of the cooking zones, indicating that the cooking zone is still hot after switching off. Even if you switch off the hob, this indicator light will be on as long as the cooking zone is hot! Do not touch the cooking zone while this indicator light is on.

			
short press	long press	swipe	acoustic signal

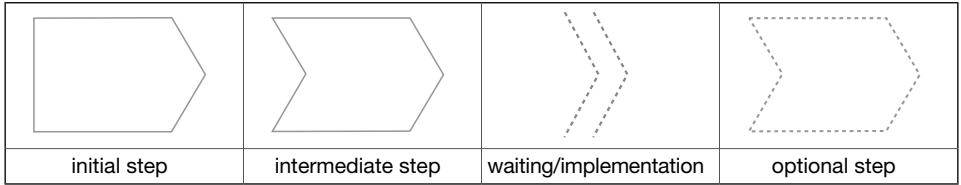

6.2 Switching the hob on/off

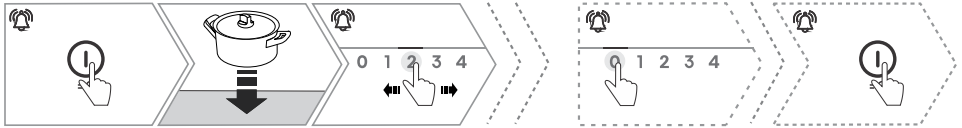

1. By pressing you switch on the cooking hob.
2. The slider indicating the cooking zones is half-illuminated (when automatic pan detection is on).
3. Place the cookware onto the selected cooking zone, and the corresponding slider bar will light up fully.
4. Set the cooking power by touching or swiping the slider. A short audible signal will be emitted.
5. Switch off the hob by pressing the key or by touching 0 on the slider on the selected zone.



INFORMATION!

If no cooking zone is switched on in 20 seconds, the induction hob will power off.



INFORMATION!

The total power of the appliance is limited and also depends on the configuration of the cooking zones. In certain cases, you cannot set two or more cooking zones to the highest power simultaneously. This is especially noticeable if an additional power limit has been set on the appliance due to the household electrical installation.

6.3 Automatic pan detection

The hob has a preset automatic detection of the presence of cookware on the cooking zone.

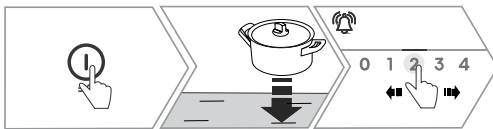

1. By pressing you switch on the cooking hob.
2. Place the cookware onto the selected cooking zone, and the hob will automatically detect the presence of cookware. The corresponding slider bar will light up fully.

Table continued from last page

3. Set any cooking level.

6.4 Pan movement detection

The hob automatically detects the movement of the pan from one cooking zone to another if the "automatic pan detection" function is enabled. All power and timer settings can be transferred.

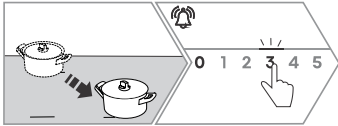

1. Transfer the cookware from one active cooking zone to another free cooking zone. The preset power level and the preset timer will start flashing on the new cooking zone.
2. Within 3 seconds, confirm the transfer of settings by pressing one of the levels on the slider of the new zone. A short audible signal will be emitted.
3. If the transfer of settings is not confirmed after the time has elapsed or when pressing level 0 on a new cooking zone, the settings are not transferred.



INFORMATION!

The pan movement function is not possible on a cooking zone with the automatic WARM, MELT or BOIL programs switched on.

6.5 Switching the cooking zone on/off

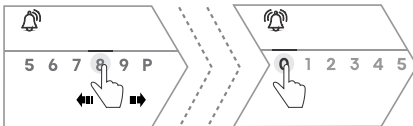

1. Touch or swipe the selected slider to select the desired power level.
2. A short beep sounds, the selected power is fully illuminated.
5. Switch off the hob by touching 0 on the slider or by pressing  to switch off the hob.

6.6 High heating setting - "Power boost"

For quick cooking, the high heating setting can be additionally activated on the cooking zones. Thus, with the additional power of the cooking zones, you can quickly heat up even larger quantities of food. The additional operating power is activated for a maximum of 10 minutes and then automatically decreases to level 9. If the hob is not too hot, it can be reactivated.



1. Place the cookware onto the selected cooking zone.
2. Set the level with increased power.
3. To switch off the "Power boost" function, reduce the cooking zone power.

6.7 Automatic heating

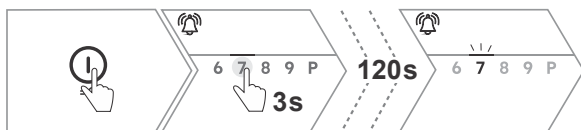

By activating the function, the selected cooking zone heats up for a period of time at a higher power, before it automatically switches to the set level. To turn on the function, select the power level and hold it for 3 seconds. The automatic function can only be switched on if the cooking zone has been switched off.

Power grade	1	2	3	4	5	6	7	8
Heating time [s]	40	70	120	180	260	430	120	195



INFORMATION!

The automatic rapid heating function is suitable for dishes that have to be heated up at maximum power first, and then cooked for a longer period of time at a lower power level without the need for constant supervision.

The automatic rapid heating function is not suitable for braising, frying, or sautéing, food that requires frequent turning, basting, or mixing, or food that has to boil for a longer period of time in a pressure cooker.

During automatic operation, the set power level is illuminated, and level 9 flashes.

During the operation of the automatic function, it will deactivate if the power level is decreased. If the power level is increased during the operation of the automatic function, the new set timer will include the time that has already elapsed at the previous selected level. If the elapsed time is longer than the time you want to reset, the automatic program will automatically end.

6.8 Bridged cooking zone - "Bridge"

(depending on the model)

The cooking zones on the left or right side of the cooktop can be combined into one large connected zone. You can place an oval baking dish or grill plate on this zone.



NOTE!

The pan must be large enough to cover the centres of the upper and lower cooking zones.

- The maximum size of the baking tray is 40 x 25 cm.
- For an even heat distribution, we recommend a baking tray with a thicker bottom.
- The baking tray gets very hot during cooking, so take care to protect against burns.
- When placing the baking tray on the hob, be careful not to cover the control module with it.

Cooking zones can be combined if:

- Both fields are inactive.
- One of the compatible zones is active – the set level of the connected cooking zone is transferred from the active zone.
- Both cooking zones are active – the set level of the connected cooking zone is transferred from the active zone that was operating at a lower level. If both cooking zones are set to the same level before combining, the same power is transferred.



1. By pressing for 1 second **1s** you activate the function. A short audible signal will be emitted.

2. Set the cooking level on the lower or upper slider.

3. Switch off the function by pressing **P** or by touching 0 on the slider. A short audible signal will be emitted.



NOTE!

Active timers that are linked to the cooking zones that you wish to combine are switched off when activated.

6.9 Pause - "Stop&Go"

With this function, you can pause the operation of the entire hob during cooking.



1. By pressing for 1 second **||** you activate the function. A short audible signal sounds, the pause key flashes, and all set timers are temporarily stopped. If the activated countdown timer is connected to the entire hob, it continues to run.

2. All buttons are inactive except **||** and .

3. By pressing for 1 second **||** within 10 minutes you deactivate the function. The hob continues to operate with the same settings as before the function was activated.

 **INFORMATION!**

If no key is pressed within 10 minutes, the hob will switch off automatically.

 **INFORMATION!**

If the global timer is activated, it remains active in Stop&Go mode and can be confirmed with any button.

6.10 Memory function - "Recall function"

In case of switching off the user interface, the function allows you to restore the cooking zone setting when switching on again.



1. Restart the user interface within 9 seconds of switching off the hob.

2. After power-up, the indicator **||** flashes for 7 seconds.

3. Within 7 seconds of switching on the appliance, activate the **||** key, to restore the settings set before switching off the hob. When the settings are restored, an acoustic signal will be emitted.

4. If the **||** key is not activated within a time interval of 7 seconds, or any other key is activated immediately after power on, the settings cannot be reversed.

6.11 Pan detection indicator



The appliance automatically detects a missing pan on an active cooking zone. In case of a missing pan, the entire slider with the set power will flash. During this time, the corresponding timers are temporarily paused on the cooking zone where no pans are present.



INFORMATION!

If you do not put the cookware back on the cooking zone within 2 minutes, an acoustic signal will be emitted and the cooking zone will be switched off.

6.12 Hot cooking zone indicator

The hob is equipped with a hot cooking zone indicator.

The cooking zone heats up via residual heat emitted by the cookware. When you remove the cookware from the cooktop or turn off the cooking zone, the indicator light  illuminates; during this time, you can use this heat to keep food warm or melt dishes.



INFORMATION!

When  goes out, the cooking zone can still be hot!



WARNING!

Be careful, there is a risk of burns!

6.13 Time functions

The appliance allows you to set a countdown timer that is connected to the entire cooking hob or to set the programme hours that are connected to each cooking zone.

Countdown timer for the entire cooking hob



The countdown timer  can only be set when the user interface is switched on. When the countdown timer is set, it will continue to count down even after the hob is switched off or while the Stop&Go function is active. After the set time expires, an audible signal is triggered, which can be deactivated by pressing any key.



INFORMATION!

After the time has elapsed, the audible signal can also be switched off when the hob is switched off or paused. Press any key to confirm.

Programme timer

After the set program timer expires , the cooking zone that was connected to the timer will be switched off and an audible signal will be heard. You can deactivate the audible signal by pressing any key. The program timer can only be set when the cooking zone is active.



Time function settings

1. By pressing / you turn on the time settings. The display starts flashing and shows the corresponding icon of the selected time function.
2. By pressing and you set the desired time in the range between 1 minute and 9 hours and 59 minutes.
3. The time function can be confirmed manually by pressing / or automatically after 7 seconds from the last change of the desired time.
4. After the timer has been successfully confirmed, an acoustic signal will be emitted and the corresponding icon for the timer function will be fully illuminated.
5. During the last minute of countdown, remaining time will be displayed in seconds.



INFORMATION!

When using two or more time functions, the associated timer icon currently displayed on the screen is fully illuminated. Other icons of the set time functions will be half-illuminated, indicating that the functions are set but currently not shown on the display. To display the selected set time function, click on the corresponding key.

Changing the time function

1. Make sure that the time function to be adjusted is shown on the display. If it is not, do so by pressing the key belonging to the time function.
2. Press again the key / , so that the timer display, together with the associated time function icon, will start flashing.
3. Change the time function arbitrarily by pressing and .
4. The time function can be confirmed manually by pressing / or automatically after 7 seconds from the last change of the desired time.

Switching off the time function

The time function can be terminated by simultaneously pressing and when it is shown on the display or if the time function to be interrupted is set to 0:00 and then confirmed (see changing the time function).

6.14 User settings

On the appliance, you can set: volume, brightness, automatic pan detection, child lock, alarm duration, external hood connection (depending on the model) and factory reset.

**INFORMATION!**

The hob must be switched off to access the user settings.

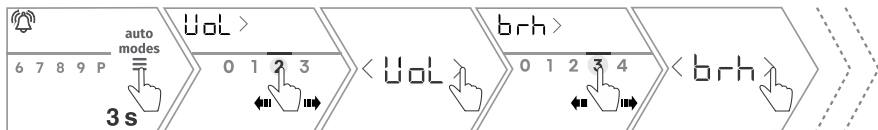

1. When the user interface is switched off, enter the parameter setting menu with a 3-second press on .
2. The display shows **SEt** and after 2 seconds it displays **UoL** .
3. Use **<** and **>** to navigate the menu between the possible settings.
4. The available settings of the selected parameter are displayed with a half-illuminated line above the values that can be set. The currently set value is fully illuminated.
5. Exit the user settings by pressing for 3 seconds the key (the settings will be saved) or the key (the settings will not be saved).

**INFORMATION!**

Entering the user settings is disabled if the active timer is connected to the entire cooking hob.

Key/Display	Description
	Setting the power limit After connecting the appliance to the mains, activate the following key . After 2 minutes, the power setting is no longer possible.
UoL	Volume adjustment Use the slider to set the desired volume level from 0 to 3.
brh	Brightness setting Use the slider to set the desired level of illumination from 1 to 3.
Aut	Automatic pan detection Use the slider to turn the function on 1 or off 0.
Loc	Child lock setting Use the 0 or 1 setting to turn on or off the automatic locking of the appliance.
dur	Alarm duration setting Use the slider to set the alarm duration from 0 to 2. 0 = 5 seconds 1 = 1 minute 2 = 2 minutes
FAc	Factory reset Long press on 1 to activate and return user settings to default values.

Table continued from last page

Key/Display	Description
Hood	Hood mode (depending on the model) The setting has a function only if the hob is connected to the cooker hood 1 = Manual mode 2 = Automatic mode (preset)
Sen	Hood sensitivity (depending on the model) The setting has a function only if the hob is connected to the cooker hood Various profiles can be set that are related to the sensitivity of the hood in automatic operation mode 2 = Medium sensitivity 3 = High sensitivity

6.15 Child lock



The hob can be locked against unwanted switching on.



INFORMATION!

The hob must be switched off to activate the child lock.



1. Touch  and hold for 3 seconds.
2. Loc appears on the timer function display. A beep sounds, and the hob is now locked.
3. When the hob is locked, touch  and hold for 3 seconds. A beep sounds, and the hob is now unlocked.

6.16 The additional functions with automatic programs

The appliance provides three additional functions: reheating, melting/defrosting and boiling.

The additional functions allow automatic temperature control, without the need to adjust the heating level during cooking.

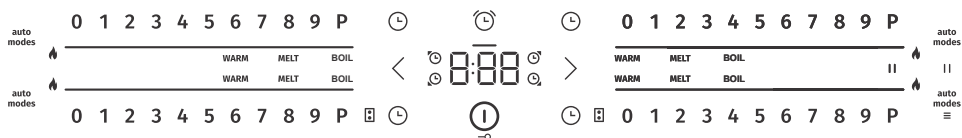

1. Pressing  opens the additional menu. The slider bar on the selected cooking zone disappears and additional functions are displayed.

Table continued from last page

2. The additional function is activated by pressing the number below or above (depending on the cooking zone) the additional function to be activated. The additional menu closes when you press ^{auto} _{modes} again or automatically if you do not select a program within 5 seconds.
3. When an acoustic signal is emitted, the additional function is activated.
4. The WARM and BOIL functions consist of a preheating phase and a temperature maintenance phase. Until the ideal temperature is reached, the additional function icon will flash. When an audible signal is emitted, the preheating phase is complete and the program icon is fully illuminated.
5. The active function can be deactivated at any time by pressing the 0 value on the corresponding cooking zone.
6. After activating the additional function, the program timer can be set on the corresponding cooking zone. After the set program timer has elapsed, the additional function is switched off (see "Timer functions" to set it).
7. If you want to change the additional function after it has already been set, do so by pressing ^{auto} _{modes}. The menu with additional programs opens. Set the desired program again or close the menu.

Key/Display	Description
WARM	Keep warm/reheat This function allows you to keep warm and reheat ready-made dishes.
MELT	Melting/defrosting The function allows you to gently melt foods such as chocolate or butter. It also allows defrosting of frozen food.
BOIL	Bringing to the boil / simmering in water This function automatically brings water to the boil and then keeps it simmering. When preheating is complete, the water has reached temperature and is ready for use. Add food after preheating is complete. Recommended for cooking dishes with a water content of more than 500ml.



INFORMATION!

Using the ConnectLife app, in addition to other additional functions, the possibility of using more than 100 guided recipes and easy monitoring of the cooking status opens up. If any additional function is started via the ConnectLife app, the display of operation on the user interface is different from the above. The user manual is available in the ConnectLife app.



INFORMATION!

If the pan is removed from the cooking zone during the active additional function, the active function is paused. The selected additional function is blinking together with the corresponding illuminated slider bar. If you put the pan back within 20 seconds, the additional function will be resumed, otherwise it will be switched off.



INFORMATION!

The additional function continues to be active even if the pause – "Stop&Go" function is used for less than 20 seconds. It can also be restored with the memory function.

6.17 Maximum cooking time

For safety reasons, the cooking time for each cooking zone on the induction hob is restricted to a maximum duration.

Maximum cooking time depends on the most recently set power level. If the power level is not changed for a long time, the cooking zone will be switched off automatically after the maximum cooking duration is reached (see table below).

Cooking power level	A**	1	2	3	4	5	6	7	8	9	P*
Maximum operating time (h)	8	8	8	6	6	4	4	2	2	1,5	1,5

* After 10 minutes, the power level automatically decreases to 9; after 1.5 hours, the cooking zone is switched off.

** Automatic programs

6.18 Automatic overheat protection

The induction hob is fitted with a cooling fan that cools the electronic components during cooking. The fan may operate for a while even after the end of the cooking process.

The hob is also fitted with an overheating protector that protects the electronics from damage. The protector operates at several levels. When the cooking zone temperature gets very high, the cooking power is automatically reduced. If this does not suffice, the cooking zone power continues to decrease, or the safety mechanism switches off the cooking zone completely. When the induction hob cools down, its total power is available again.

6.19 Automatic switch off

If the keys are activated for too long during cooking (e.g., due to spilt liquid or an object placed over the sensor keys), all cooking zones will be switched off automatically after 10 seconds.

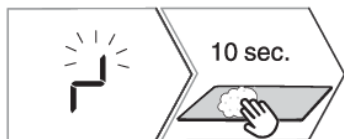

1. On the display flashes r^{I} .

2. Remove the object or wipe spilt liquid from the sensor keys within 5 seconds to retain the power level settings. If you do not remove the object or wipe the spilt liquid within 10 seconds, the induction hob will be powered off automatically.

6.20 ConnectLife

Connecting the appliance to the ConnectLife application

ConnectLife is a smart home platform that connects people, devices and services. The **ConnectLife** application includes advanced digital services and carefree solutions that allow users to monitor and control appliances, receive notifications from a smartphone, and update software (supported features may vary depending on your appliance and the region/country in which you are located).

To connect your smart device, you need a home Wi-Fi network (only 2.4 GHz networks are supported) and a smartphone equipped with the application **ConnectLife**.

 **ConnectLife**



To download the **ConnectLife**, application, scan the QR code or search for **ConnectLife** in your favourite app store.

1. Install the **ConnectLife** application and create an account.
2. In the **ConnectLife** application, go to the "Add device" menu and select the appropriate type of device. Then scan the QR code (it can be found on the nameplate of the appliance; you can also enter the AUID/MV number manually).
3. The application then guides you through the entire process of connecting the appliance to your smartphone.
4. After a successful connection, the appliance can be operated remotely via the mobile application.

6.21 Wi-Fi management

(depending on the model)

To enter the Wi-Fi module function settings, switch on the appliance and press .





1.	Switching on the Wi-Fi module: Press and hold the key between 1 and 4 seconds to activate the Wi-Fi module. The display will show "On". When you release the key, the Wi-Fi module is activated. After activation, the  symbol will flash.
2.	Connecting the appliance: With a long press of the key (between 4 and 7 seconds), "CSt" will appear on the display unit. By releasing the key, the connection is activated. A 5-minute timer appears on the display. During this time, scan the enclosed 3D code. NOTE: For further settings, follow the instructions in the ConnectLife app.

Table continued from last page



3.	Connecting additional users: To connect additional users, press and hold the key (between 7 and 10 seconds) until "PAr" appears on the display unit. By releasing the key, a 3-minute timer appears. During this time, additional users can be connected to the device using the ConnectLife app. After successfully establishing the connection, the Wi-Fi symbol will  stay on. NOTE: To continue the set-up, follow the instructions in the ConnectLife app.
4.	Removing all connected users: After long-pressing the key (between 10 and 13 seconds), UPr will appear on the display unit, and a line will flash below the timer key. By pressing the timer, you activate the remove function. When you enter the menu, a 1-minute timer is displayed, which is present until the connected users are removed from the device. Use this setting to remove all connected users from the ConnectLife app.
5.	Switching off the Wi-Fi module: After long-pressing the key (between 13 and 16 seconds), "OFF" will appear on the display unit. By releasing the key, the Wi-Fi module is switched off. After switching off the module, the symbol  goes out.

6.22 Connecting an external hood - "Hob to Hood"

(depending on the model)

A connected appliance allows an external hood that is compatible with your appliance to be connected. Check with the manufacturer for compatible hoods.

Switch on the user interface and make sure that the cooking zones are not active.

1. Switch on the Wi-Fi module (see chapter 5.18 Wi-Fi operation)
2. Before using the Hob to Hood function for the first time, the hob must be updated using the ConnectLife app
3. To pair the devices, press and hold  (between 7 and 10 seconds) until "PAr" appears on the display unit. By releasing the key, a 3-minute timer appears. During this time, enable pairing on the other device (see the instructions of the external hood). The devices are automatically connected.
4. After successfully establishing the connection, the symbol  will stay on.
5. To disconnect the appliance from the hood, press and hold  until the "UPr" menu appears, and a line flashes below the timer key. By pressing the timer, you activate the remove function. When you enter the menu, a 1-minute timer is displayed, which is present until the connected users are removed from the device.



INFORMATION!

With the "UPr" function, you will also remove other connected users at the same time as the hood.

7. Tips and hints

7.1 Cooking hob (conventional or glass ceramic)

- The hob is resistant to temperature changes.
- Using the cooking hob surface as a storage area may result in scratches or other damage to it.
- Do not use the glass ceramic hob if it is cracked or broken. If a sharp object falls on the hob, the hob may break. The consequences of such occurrence may be visible immediately or only after a while.
- If any visible crack appears in the hob, immediately cut off the power supply to the appliance.
- Make sure the cooking zone and the cookware bottom is clean and dry. This will allow better conduction of heat and prevent any damage to the heating surface.
- Do not place empty cookware on the cooking zone, as this may result in damage.



WARNING!

If sugar or food with high sugar content is spilled over a hot glass ceramic hob, immediately wipe the hob or remove the sugar with a scraper, even if the cooking zone is still hot. This will prevent any damage to the glass ceramic surface.

Do not use detergents and other cleaners to clean a hot glass ceramic hob as this could damage the surface.

7.2 Induction cooking zone operating principle

Cooking on an induction hob differs from cooking on traditional appliances. Induction hob uses magnetic field for generating heat and cooking. This means that not all types of cookware can be used on an induction hob.

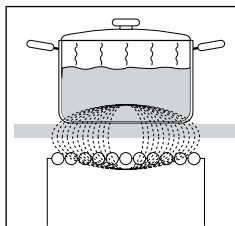

The cooking hob is fitted with highly efficient induction cooking zones. The heat is generated directly in the bottom of the pan where it is needed the most. This avoids any losses through the glass ceramic surface. Power consumption is considerably lower than in conventional cooking zones with radiation heaters.

The glass ceramic cooking zone is not heated directly, but only indirectly with the heat radiated back by the pan. After the cooking zone is switched off, this residual heat is indicated by  .

In induction cooking zones, heating is made possible by the induction coil installed under the glass ceramic surface. The coil induces a magnetic field which generates eddy currents in the bottom of a ferromagnetic pan, which in turn heats the pan.

The induction will work correctly if you use suitable cookware.

7.3 Induction cookware

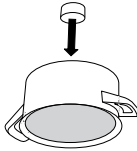
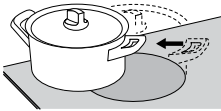
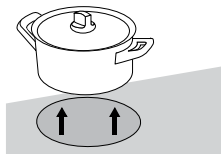
	<p>The magnet test: Use a small magnet to check whether the pan or pot bottom is ferromagnetic. If the magnet sticks to the bottom of the pan, then it is suitable for an induction cooker.</p>
	<p>Make sure the pot or pan is in the middle of the cooking zone</p>
	<p>For best cooking results, the ferromagnetic area on the cookware bottom should match the size of the cooking zone. If the cooking zone does not recognize the pan, try placing it on a different cooking zone with a smaller diameter.</p>

Suitable cookware	Unsuitable cookware
steel	glass
enamel-coated steel	alloy steel with copper bottom
cast iron	alloy steel with aluminium bottom

- When using a pressure cooker, keep an eye on it until the right pressure is reached. First, set the cooking zone to maximum power; then, following the pressure cooker manufacturer's instructions, decrease the cooking power when appropriate.
- Make sure there is enough liquid in the pressure cooker, or any other pot or pan. Due to overheating, using an empty pot on the cooking zone may result in damage to both the pot and the cooking zone.
- Some cookware does not have a fully ferromagnetic bottom. In such case, only the magnetic part will heat up, while the rest of the bottom will remain cool.
- When using special cookware, observe the manufacturer's instructions.

Cooking zone	Minimum pan bottom diameter
Ø 145 mm	Ø 90 mm
Ø 180 mm	Ø 110 mm
Ø 230 mm	Ø 110 mm
Ø 195 x 210 mm	Ø 110 mm

Pan bottom has to be flat.

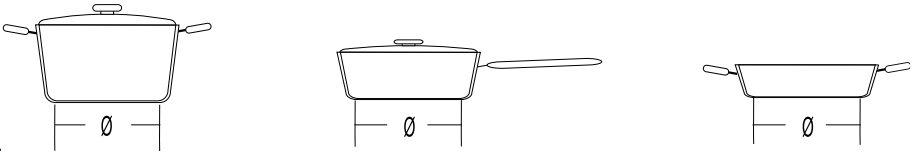

7.4 Energy saving tips

- When purchasing cookware, consider that the diameter indicated on the pan usually pertains to the upper edge or the lid, which is normally larger than the diameter of the pan bottom.
- If a dish takes a long time to cook, use a pressure cooker. Make sure there is always sufficient liquid in the pressure cooker. If an empty cooker is placed on the cooking hob, it may overheat which in turn may lead to damage to both the pot and the cooking zone.
- Whenever possible, cover the pot or pan with a suitably sized lid. Use cookware that fits the amount of food you are cooking. Cooking in a large partly full pot will consume much more energy.
- Even if there is no pot or pan on the cooking zone or if the pan used has a diameter that is smaller than the diameter of the cooking zone, there will be no losses of energy.
- If the pan is much smaller than the cooking zone, there is a possibility that it will not be detected.
- If a smaller pan or pot is placed on the cooking zone and it is recognized, the hob will only use as much power as necessary given the pan size.

8. Cleaning and maintenance

After each use, wait for the glass-ceramic surface to cool down and clean it. Otherwise, all remaining impurities will burn onto the hot surface the next time you use the hob.

For regular maintenance of the glass-ceramic hob, use special care products that create a protective film on the surface to prevent the dirt from sticking onto it.

Before each use of the glass-ceramic surface, wipe off the dust or any other impurities that could scratch the surface, from both the hob and the pan bottom.



INFORMATION!

Steel wool, coarse cleaning sponges, and abrasive powders may scratch the surface. The surface may also be damaged by aggressive spray cleaners and unsuitable liquid cleaners.

Signage may be worn when using aggressive or abrasive cleaners or cookware with coarse or damaged bottom.

Use a damp soft cloth to remove minor impurities. Then, wipe the surface dry.

Remove water stains with a mild vinegar solution, which should not be used to wipe the frame (in some models), as it could lose its shine. Do not use aggressive sprays or cleaners to remove limestone.

Remove heavy dirt with special cleaners for cleaning glass-ceramic surfaces. Follow the detergent manufacturer's instructions. Be careful to thoroughly remove cleaner residues after cleaning, as they may damage the glass-ceramic surface when heated up.

Remove stubborn and burnt dirt with a scraper. When using the scraper, be careful not to injure yourself.

Immediately remove any sugar or sugar-laden food from the glass-ceramic hob using a scraper, even if the hob is still hot, as sugar may permanently damage the glass-ceramic surface.



INFORMATION!

The scraper is not included in appliance equipment.

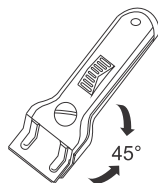

INFORMATION!

Only use the scraper when dirt cannot be removed with a wet cloth or special cleaners for glass-ceramic surfaces.

Hold the scraper at the correct angle (45° to 60°). Gently press the scraper against the glass and slide it over the signage to remove the dirt. Make sure the plastic handle of the scraper (in some models) does not come into contact with a hot cooking zone.



INFORMATION!

Do not press the scraper perpendicularly against the glass and do not scratch the hob surface with its tip or blade.

9. Problems and errors

During the warranty period, only a service centre authorised by the manufacturer may carry out any repairs.



Before making any repairs, make sure the appliance is disconnected from the power mains by disconnecting the fuse.

Do not perform any unauthorised repairs to the appliance, as this may result in electric shock and a short circuit hazard. Such work should be left to a professional or a service technician.

In case of minor issues with the operation of the appliance, refer to this manual to see if the problem can be fixed by yourself.

Keep this user manual for future reference and pass it on to any subsequent owners or users of the appliance.

Following is some advice on rectifying some common problems.

Problem/error	Cause of/rectifying a fault
The main fuse in your home trips often.	To troubleshoot the problem, check that you have the correct input current limit set in the user settings (parameter). In the event that the problem is still present, call a service technician. 
Audible signal and display 	Water spilt over the sensor surface, or an object placed over the sensors. Wipe the sensor surface.
Poor key responsiveness	Clean the operating area of the appliance and dry it completely. Remove any pans or plates. Allow the appliance to cool. Disconnect the appliance from the power mains for one minute (unscrew the fuse or switch off at the main power switch).
Hot	The user interface is too hot to operate. Please wait for the interface to cool down.
Err	Appliance could not connect to the ConnectLife app or disconnect from it. Try a factory reset.
E20, E47, E48	Internal fault in the electronics. Disconnect the appliance from the power mains for one minute (unscrew the fuse or switch off at the main power switch).
E42	Fault on the control interface. Clean the control interface area and allow it to dry. Disconnect the appliance from the power mains for one minute (unscrew the fuse or switch off at the main power switch).
E00, E01, E02, E03, E04, E05, E21	Check that the appliance is properly connected to the power mains and that all terminal contacts are properly screwed in. Check whether the connected voltage is suitable.
E18	Insufficient cooling of the appliance. Check that the appliance is installed according to the user manual.
E19	The cooking zone temperature is too high. Do not attempt to heat empty pans.

If, despite following the above tips, you are unable to remedy the interference, disconnect the appliance from the power mains for one minute (unscrew the fuse or switch off at the main power switch). If the error reappears, please call a service technician. Elimination of defects or complaints arising from improper connection or use of the appliance are not covered by the warranty. In this case, the repair costs will be borne by you.



WARNING!

Before repairs, disconnect the appliance from the power mains (by removing the fuse).

9.1 Noises during induction cooking

Noises and sounds	Cause	Solution
Inductiongenerated operating noise	Induction technology is based on the properties of some metals under electromagnetic effect. It results in so-called eddy currents that force the molecules to oscillate. These oscillations (vibrations) are transformed into heat. Depending on the type of metal, this could result in quiet noises.	This is normal and it is not a result of any malfunction.
Transformer-like buzz	Occurs when cooking at a high power level. The reason for this is the amount of energy transferred from the cooking hob to the pot or pan.	This noise will disappear or weaken when you reduce the power level.
Vibration and crackling of the cookware	This noise appears in cookware (pots or pans) made of different materials.	It results from vibrations along the adjacent surfaces of different material layers. This noise depends on the cookware. It can vary depending on the amount and type of food being cooked.
Fan noise	Correct operation of induction electronic components requires temperature control. Therefore, the cooking hob is fitted with a fan that cools the electronics depending on the sensed temperature.	The fan may operate even after the cooking hob has been switched off, if the temperature remains too high.

10. Technical data

(depending on the model)

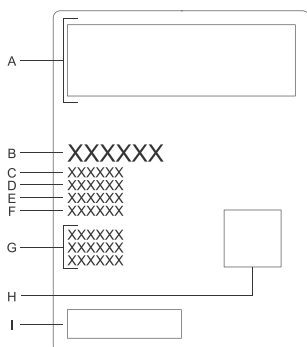

- A. Wiring diagram
- B. Trademark
- C. Model
- D. Type
- E. Code
- F. Serial number
- G. Technical data
- H. QR code
- I. Compliance labels

The rating plate with basic information on the appliance is located on the bottom side of the cooking hob. Information on appliance type and model can be found on the warranty sheet.

11. Disposal



Our product packaging is made of environmentally friendly materials that can be recycled, disposed of, or destroyed without any hazard to the environment. To this end, packaging materials are labelled appropriately.

The symbol on the product or its packaging indicates that the product should not be treated as normal household waste. Take the product to an authorized collection centre for waste electric and electronic equipment processing.

Correct **disposal** of the product will help prevent any negative effects on the environment and health of people, which could occur in case of incorrect product removal. For detailed information on removal and processing of the product, please contact the relevant municipal body in charge of waste management, your waste disposal service, or the store where you bought the product.

We reserve the right to any changes and errors in the instructions for use.

12. Compliance information

Radio equipment type:	HLW3215-TG01 module
Wi-Fi indicator	
Operating frequency range:	2.4000 GHz - 2.4835 GHz
Maximum output power:	≤10 dBm/MHz (EIRP) (Antenna gain <10 dBi)
Maximum antenna gain:	Gain: 0 dBi
Bluetooth indicator	
Frequency range:	2.400 GHz - 2.4835 GHz
Carrier Output:	6 dBm (≤10 dBm)
Emission type:	F1D

The company declares that the device with the function Connectlife complies with the essential requirements and other relevant provisions of Directive 2014/53/EU. The detailed Declaration of Conformity can be found at the web address <https://auid.connectlife.io> on the page of your device among the additional documents.

gorenje



927113-a19

