





Before Getting Started

Read and follow safety instructions. Refer to product data plate(s) for additional operating instructions and specifications.

This is the safety alert symbol. When you see this  symbol on your pump or in this manual, look for one of the following signal words and be alert to the potential for personal injury or property damage if ignored:

 **DANGER** warns about hazards that will cause serious personal injury, death or major property damage if ignored.

 **WARNING** warns about hazards that can cause serious personal injury, death or major property damage if ignored.

 **CAUTION** warns about hazards that will or can cause minor personal injury or major property damage if ignored.

 **NOTICE** indicates special instructions which are important but not related to hazards. Carefully read and follow all safety instructions in this manual and on pump.



WARNING

 **WARNING RISK OF ELECTRIC SHOCK** - This pump is supplied with a grounding conductor and grounding type attachment plug. To reduce risk of electric shock, be certain that it is connected only to a properly grounded, grounding-type receptacle. Disconnect power before working on or around the sump pump or battery backup system.

This equipment should be installed by technically qualified personnel. Failure to install in compliance with national, local electrical, and within Franklin Electric recommendations may result in electrical shock or fire hazard, unsatisfactory performance, or equipment failure. Installation information is available through pump manufacturers and distributors, or directly from Franklin Electric at our toll free number 1-800-701-7894.

This equipment must not be used by children or persons with reduced physical, sensory or mental abilities, or lacking in experience and expertise, unless supervised or instructed. Children may not use the equipment, nor may they play with the equipment or in the immediate vicinity.

If the power cord is damaged, it must only be replaced by qualified personnel.

- Keep work area clean, well-lit, and uncluttered.
- Keep safety labels clean and in good condition.
- Wear safety glasses while installing or performing maintenance on pump.
- Do not run pump dry. Fill pump with water before starting or pump will be damaged.
- Make sure all **ELECTRICAL POWER IS OFF** before connecting any electrical wires. Wire sump pump system for correct voltages. Follow all pump wiring instructions provided in the “Wiring” section of this manual.

CAUTION

- Keep work area clean, well-lit, and uncluttered.
- Keep safety labels clean and in good condition.
- Wear safety glasses while installing or performing maintenance on pump.
- Do not run pump dry. Fill pump with water before starting or pump will be damaged.
- Make sure all **ELECTRICAL POWER IS OFF** before connecting any electrical wires. Wire sump pump system for correct voltages. Follow all pump wiring instructions provided in the “System Wiring Diagram” and “Electrical Connections” sections of this manual.

Table of Contents

- Getting Started 4
- Specifications 5
- Pump Performance Curves..... 7
- Installation of Backup System on Common Discharge (Models SPBS-10HF and SPBS-12HF)..... 8
- Installation of Backup System on Separate Discharge (Models SPBS-10HF and SPBS-12HF). 11
- Installation of Pre-assembled Backup System on Common Discharge
(Models SPBS-10HF-6 and SPBS-12HF-10) 14
 - Charger/Controller Unit Installation..... 15
 - Electrical Connections..... 17
 - System Wiring Diagram 17
- Charger/Controller Unit Operation 18
- Sump System Operation Testing 19
- System Maintenance..... 20
- System Troubleshooting 21
- Limited Warranty 22



Getting Started

This owner's manual provides you with the information required to safely own and operate your Little Giant battery backup system. Retain these instructions for future reference. The Little Giant battery backup system you have purchased is of the highest quality workmanship and material, and has been engineered to give you long and reliable service. Little Giant pumps are carefully tested, inspected, and packaged to ensure safe delivery and operation. Please examine your pump carefully to ensure that no damage occurred during shipment. If damage has occurred, please contact the place of purchase. They will assist you in replacement or repair, if required.

⚠ WARNING READ THESE INSTRUCTIONS CAREFULLY BEFORE ATTEMPTING TO INSTALL, OPERATE, OR SERVICE YOUR LITTLE GIANT PUMP. KNOW THE PUMP'S APPLICATION, LIMITATIONS, AND POTENTIAL HAZARDS. PROTECT YOURSELF AND OTHERS BY OBSERVING ALL SAFETY INFORMATION. FAILURE TO COMPLY WITH THESE INSTRUCTIONS COULD RESULT IN PERSONAL INJURY AND/OR PROPERTY DAMAGE!

Description

The battery backup system is designed as a backup to work in conjunction with a primary sump pump providing operation during temporary power outages or if the primary pump fails to function due to a blown fuse, tripped circuit breaker, defective switch, debris clogging the primary pump, or for any other reason.



⚠ DANGER Do not use to pump flammable or explosive fluids such as gasoline, fuel oil, kerosene, etc. Do not use in explosive atmospheres. Pump should only be used with liquids compatible with pump component materials. Do not handle pump or Charger/Controller Unit with wet hands or when standing on a wet or damp surface, or in water.

⚠ WARNING To reduce risk of electric shock which can result in personal injury, death or major property damage if ignored, be certain that the 115 VAC pump and the Charger/Controller Unit are connected to outlets protected by ground fault circuit interrupters (GFCI). Comply with all national and local electrical and plumbing codes when installing this unit. Do not use the same 115 VAC outlet for primary pump and Battery Charger/Controller Unit. Do not use extension cord.

⚠ WARNING A spark near the battery may cause an explosion. Always unplug Charger/Controller Unit prior to making connections to or disconnections from the battery. Take care to prevent accidental shorting across battery terminals during handling. Do not leave battery uncovered. Attach or strap cover security on battery box when completing installation.

⚠ CAUTION The battery required to operate this unit contains acid and proper precautions must be taken when handling. Refer to battery manufacturer's safety guidelines. Failure to use proper personal protective equipment or electrical caution can result in hazards that will or can cause personal injury or major property damage if ignored.

⚠ CAUTION If a Carbon Monoxide (CO) sensor is installed near the battery backup system, battery, or Charger/Controller Unit, nuisance or false alarms could result. CO detectors should be a minimum of 15 feet from the systems. Refer to the manufacturer of CO detector for additional instructions or information.

⚠ NOTICE The Charger/Controller Unit emits an audible alarm when running the 12 VDC backup pump. An additional (not supplied in this kit) audible high water alarm on the sump system is recommended in any installations where property damage and/or personal injury might result from an inoperative sump system due to long term power outages, discharge line blockage, or any other reason.

Specifications

Item Number	Model Number								
506406	SPBS-10HF								
Charging Unit	Model Number	Volts	Hz	Max Input Amps at 115 VAC	Max Output Amps at 12 VDC	Watts	Cord (ft)	Weight (lb)	Battery Leads (ft)
Item Number									
106469	1210HF	115 VAC	60	3	10	345	6	5	6
Backup Pump Switch	Model Number	Volts	Hz	Switch On Level	Switch Off Level	Watts	Cord (ft)	Weight (lb)	Battery Leads (ft)
Item Number									
105601	RS-12	12 VDC	-	13.5"	9"	-	9	0.5	-
Backup Pump	Model Number	Volts	Hz	Amps		Watts	Cord (ft)	Weight (lb)	Battery Leads (ft)
Item Number				FLA	Start				
106963	2500	12 VDC	-	14	32	168	6	6	-

Item Number	Model Number								
506407	SPBS-12HF								
Charging Unit	Model Number	Volts	Hz	Max Input Amps at 115 VAC	Max Output Amps at 12 VDC	Watts	Cord (ft)	Weight (lb)	Battery Leads (ft)
Item Number									
106486	1212HF	115 VAC	60	3	12	345	6	5	6
Backup Pump Switch	Model Number	Volts	Hz	Switch On Level	Switch Off Level	Watts	Cord (ft)	Weight (lb)	Battery Leads (ft)
Item Number									
105601	RS-12	12 VDC	-	13.5"	9"	-	9	0.5	-
Backup Pump	Model Number	Volts	Hz	Amps		Watts	Cord (ft)	Weight (lb)	Battery Leads (ft)
Item Number				FLA	Start				
106961	3360	12 VDC	-	15	32	180	6	6	-



Specifications

Item Number	Model Number								
506411	SPBS-10HF-6								
Charging Unit									
Item Number	Model Number	Volts	Hz	Max Input Amps at 115 VAC	Max Output Amps at 12 VDC	Watts	Cord (ft)	Weight (lb)	Battery Leads (ft)
106469	1210HF	115 VAC	60	3	10	345	6	5	6
Backup Pump		AMPS							
Item Number	Model Number	Volts	Hz	FLA	Start	Watts	Cord (ft)	Weight (lb)	Battery Leads (ft)
106963	2500	12 VDC	-	14	32	168	6	6	-
Backup Pump Switch									
Item Number	Model Number	Volts	Hz	Switch On Level	Switch Off Level	Watts	Cord (ft)	Weight (lb)	Battery Leads (ft)
105601	RS-12	12 VDC	-	13.5"	9"	-	9	0.5	-
Primary Pump									
Item Number	Model Number	Volts	Hz	Horsepower (HP)	Amps - FLA	Watts	Cord (ft)	Weight (lb)	Battery Leads (ft)
506807	6EC-CIA-SFS	115 VAC	60	1/3	5	600	10	30	-

Item Number	Model Number								
506410	SPBS-12HF-10								
Charging Unit									
Item Number	Model Number	Volts	Hz	Max Input Amps at 115 VAC	Max Output Amps at 12 VDC	Watts	Cord (ft)	Weight (lb)	Battery Leads (ft)
106486	1212HF	115 VAC	60	3	12	345	6	5	6
Backup Pump		Amps							
Item Number	Model Number	Volts	Hz	FLA	Start	Watts	Cord (ft)	Weight (lb)	Battery Leads (ft)
106961	3360	12 VDC	-	15	32	180	6	6	-
Backup Pump Switch									
Item Number	Model Number	Volts	Hz	Switch On Level	Switch Off Level	Watts	Cord (ft)	Weight (lb)	Battery Leads (ft)
105601	RS-12	12 VDC	-	13.5"	9"	-	9	0.5	-
Primary Pump									
Item Number	Model Number	Volts	Hz	Hz	Amps - FLA	Watts	Cord (ft)	Weight (lb)	Battery Leads (ft)
510803	10EC-CIA-SFS	115 VAC	60	1/2	6.5	750	10	26	-



Pump Performance Curves

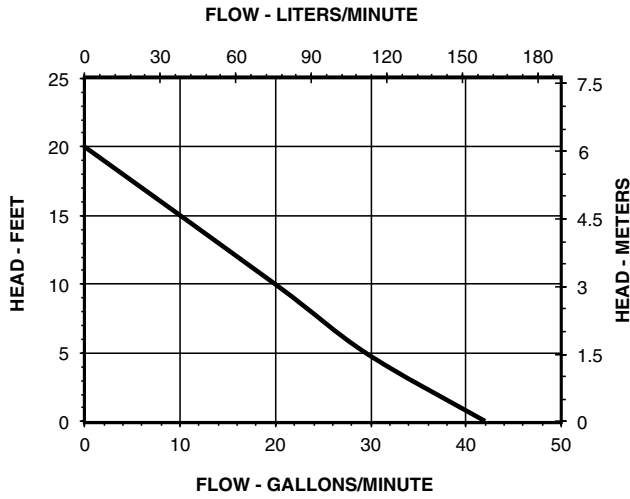

2500 12 VDC (106963)

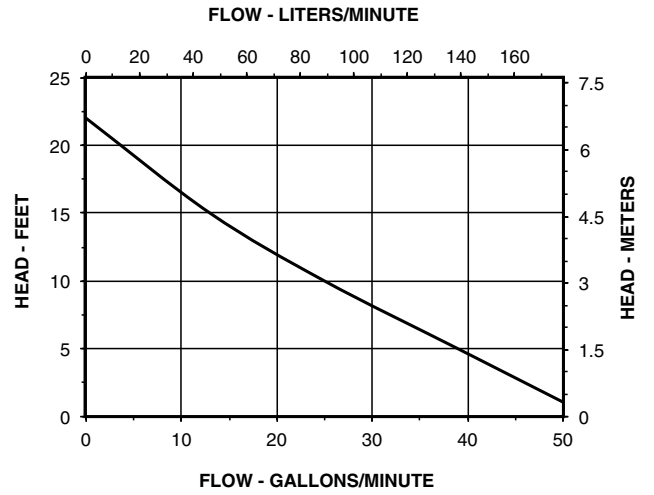

3360 12 VDC (106961)

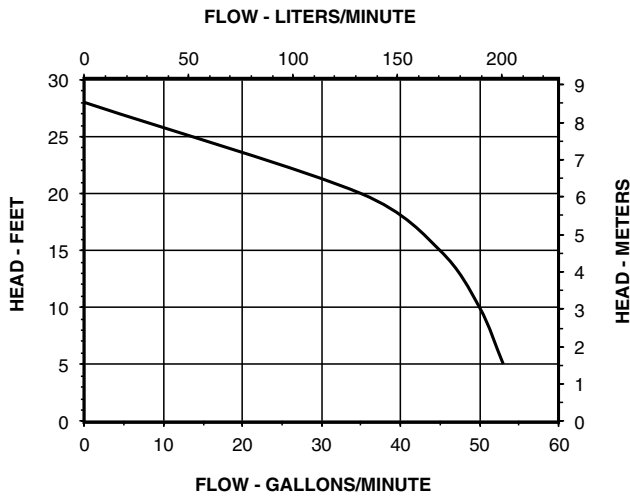

6EC-CIA-SFS (506807)

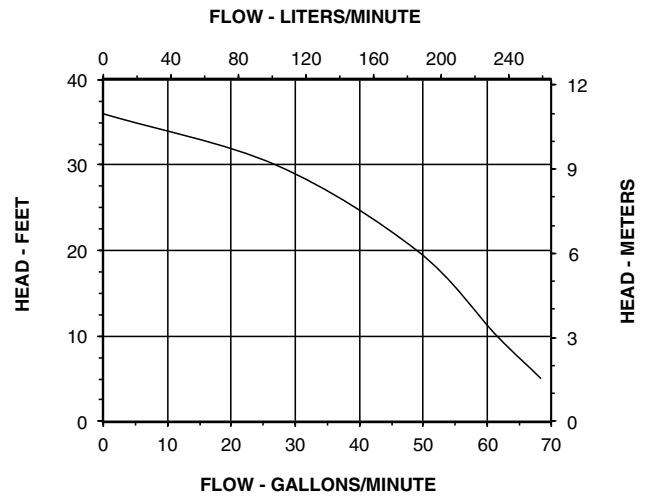

10EC-CIA-SFS (510803)



Installation of a Backup System on a Common Discharge

(For 12 VDC Backup Systems SPBS-10HF and SPBS-12HF which do not include a 115 V primary sump pump assembly)



WARNING Comply with all national and local electrical and plumbing codes when installing this unit. Disconnect power from all electrical equipment housed within the sump system before working on or around the sump pump or battery backup system beginning with 115 VAC powered pumps, level switches, and charger controllers; followed by DC powered items. Includes all items such as pumps, level control switches, Charger/Controller Unit, and battery systems.

Included in the SPBS-10HF and SPBS-12HF Kits:

1. Battery charger/controller
2. Battery case (battery not included)
3. (1) 1-1/2" street elbow near 12 VDC pump
4. Flexible coupling from 12 VDC pump discharge
5. Check valve for 12 VDC pump
6. Switch to control 12 VDC pump
7. 12 VDC backup pump
8. (4) Cable ties

Customer required to purchase separately:

1. 12 VDC deep cycle battery – BCI Group 27, rated 85 – 140Ah, lead-acid or AGM
2. 115 VAC primary pump. Little Giant's 6EC-CIA-SFS or 10EC-CIA-SFS automatic pump is recommended
3. Check valve for 115 VAC pump
4. 1-1/2" pipe as needed
5. 1-1/2" DWV street elbow H-SPG 45 degree
6. 1-1/2" DWV wye
7. Fittings – as required

Backup System on a Common Discharge

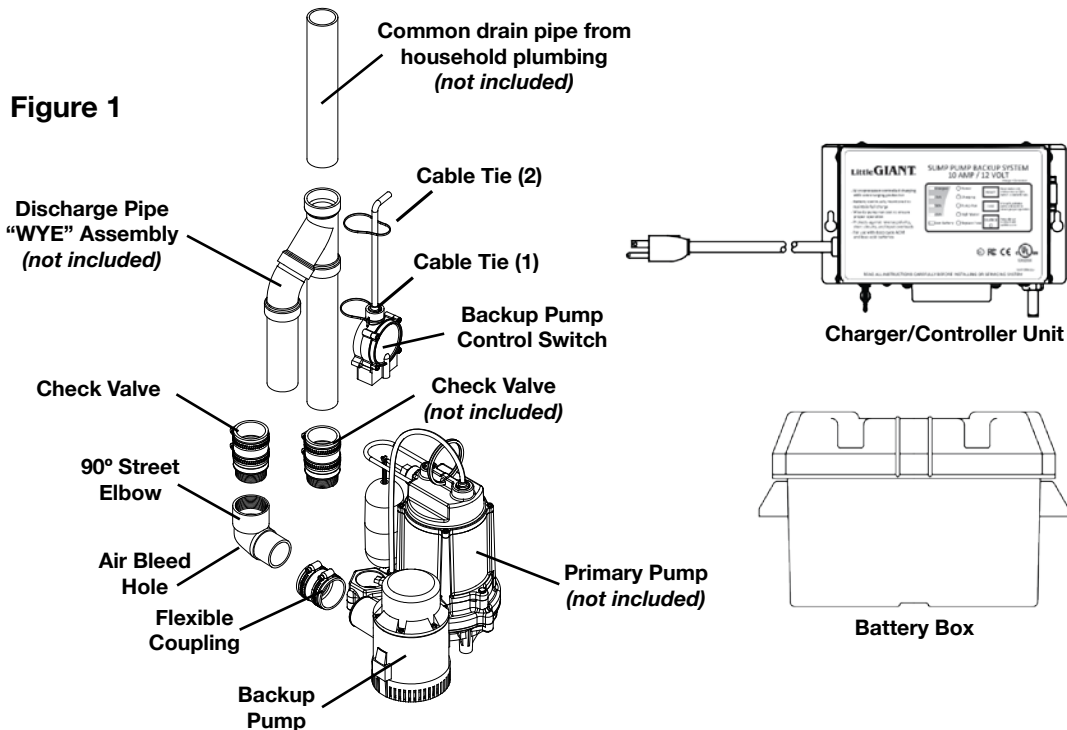

⚠ CAUTION Reduction of plumbing sizes from what is used for the discharges of the primary 115 VAC pump and 12 VDC pump can result in system underperformance. Discharge piping that is of insufficient size can result in premature pump and/or system operation failure.

Figure 2

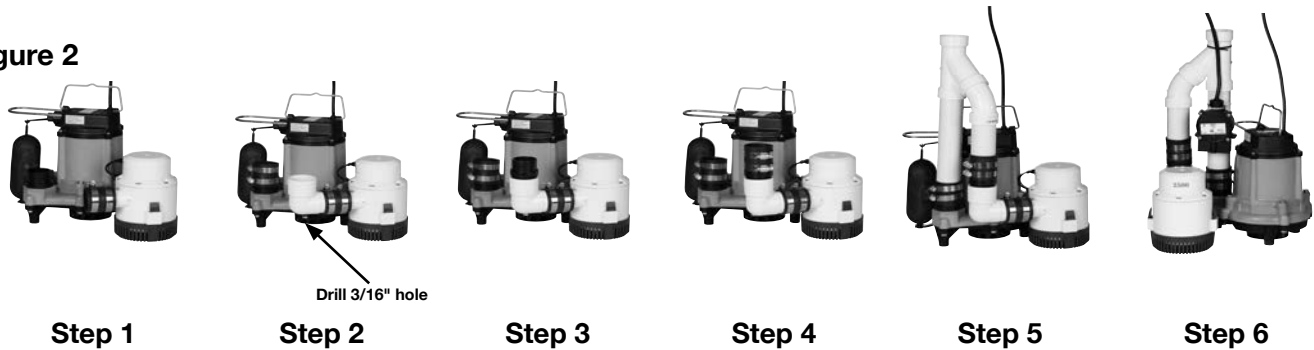

⚠ NOTICE: Do not glue any parts until the entire assembly, including primary pump, has been dry-assembled to verify fits. Fitting plumbing and routing wiring away from control floats will be much easier on a bench rather than working down inside a sump pit. (Fig. 2)

Step 1

- Install flexible coupling onto 12 VDC pump discharge.
- Position two hose clamps in the grooved recesses of flexible coupling installed on the 12 VDC pump.
- Tighten the flexible coupling's first hose clamp connection to securely fasten it to the 12 VDC pump discharge.
- Leave the hose clamp on the opposite end loose for the next plumbing piece.

Step 2

- A 3/16" diameter air bleed hole has been drilled in the 90° street elbow that is provided with the kit. (**NOTICE:** Air bleed hole must be located between the check valve and the 12 VDC pump to prevent the 12 VDC pump from air-locking.) The bleed hole is located so that the water flow through it will be at a downward angle to prevent splashing from the basin/pit.
- Slip 90° street elbow into the flexible coupling attached to the 12 VDC pump discharge, and tighten the hose clamp to secure elbow to the 12 VDC pump's discharge. (When properly installed the threaded elbow connection of the 90° street elbow should be facing straight up toward the top of the sump pit).

Step 3

⚠ NOTICE: A check valve is supplied and required for the backup pump's discharge plumbing. This check valve must be installed in the discharge plumbing between the backup pump and the wye connection joining the backup pump's discharge to that of the primary pump's discharge.

- Apply PTFE tape to male threads of provided check valve.
- Thread PTFE taped end of check valve into 90° elbow.

Step 4

- Position two hose clamps in the grooved recesses of the flexible coupling on the check valve installed in the elbow.
- Tighten the lower hose clamp to secure the flexible coupling to the check valve body.
- Loosely tighten the upper hose clamp so it does not fall off. This clamp will be used to secure the check valve to the discharge pipe "wye" assembly.

Step 5

- Review the discharge plumbing of the 115 VAC primary pump.

⚠ NOTICE: A customer-supplied check valve is required in the discharge plumbing of the 115 VAC primary sump pump.

- This check valve must be installed in the discharge plumbing between the primary pump and the wye connection joining the backup pump's discharge to that of the primary pump's discharge. A 3/16" diameter air bleed hole must be located between the check valve and the 115 VAC pump to prevent the 115 VAC pump from air-locking. Locate the bleed hole so that the water flow through it will be at a downward angle to prevent splashing from the basin/pit.
- The 1-1/2" PVC pipe used in making the discharge pipe "wye" assembly must be cut so as to ensure that both the 115 VAC primary pump and the 12 VDC backup pump rest flat on the floor of the sump basin when the plumbing is completely assembled and to align connection to the drain piping from the home. Dry-fit the assembly to confirm prior to gluing (see Figure 1).
 - Once dry-fit confirms that both pumps rest flat on the sump basin floor and the wye Assembly piping aligns with drain piping from the home, secure all connections by applying approved waterproof adhesive to all necessary joints and confirm that all flexible coupling hose clamps are fully engaged with plumbing and fully tightened.

Step 6

- a. Cable Ties (1) and (2) will be used to attach the 12 VDC pump control switch housing and power cord to the discharge pipe. Installing both cable ties to 12 VDC pump control switch is critical for proper operation of 12 VDC pump. (see Figure 1).
- b. Thread cable tie (1) through the eyelets on the 12 VDC pump control switch housing.
- c. Position the 12 VDC pump control switch on the discharge pipe such that cable tie (1) is 4" to 6" above the "ON" water level of the 115 VAC primary pump.
- d. Tighten cable tie (1) to secure the 12 VDC pump control switch to the discharge pipe.
- e. Install cable tie (2) around both the power cord of the 12 VDC pump control switch and the discharge pipe such that the power cord is securely routed away from any control floats.
- f. Use electrical tape to further secure the power cord of the 12 VDC pump control switch to the discharge pipe.

▲ NOTICE: RS-12 switch cord contains a breather tube. Be sure switch cord is not pinched so that breather tube is obstructed. Non-restrictive air flow in breather tube is required for proper RS-12 operation.

▲ NOTICE: For proper pump operation the exit point of all drain piping from the home must be lower, or sloping away, from the discharge plumbing's highest point. Improper water drainage can allow freezing within the line leading to system or component damage or failure.

▲ CAUTION Ensure all hose clamp connections and threaded connections are tight, and that all plumbing slip fit connections are properly glued prior to starting the sump pump system. Failure to do so can result in damage to pump system and/or cause property damage due to flooding.

▲ CAUTION Do not install or store the pump where it will be exposed to the weather or to temperatures below freezing or damage to the pump will occur.

Installation of a Backup System on a Separate Discharge

(For 12 VDC Backup Systems SPBS-10HF and SPBS-12HF which do not include a 115 V primary sump pump assembly)



WARNING Comply with all national and local electrical and plumbing codes when installing this unit. Disconnect power from all electrical equipment housed within the sump system before working on or around the sump pump or battery backup system beginning with 115 VAC powered pumps, level switches, and charger controllers; followed by DC powered items. Includes all items such as pumps, level control switches, Charger/Controller Unit, and battery systems.

Included in the SPBS-10 and SPBS-12 Kits:

1. Battery charger/controller
2. Battery case (battery not included)
3. (1) 1-1/2" 90° street elbow near 12 VDC pump
4. Flexible coupling from 12 VDC pump discharge
5. Check valve for 12 VDC pump
6. Switch to control 12 VDC pump
7. 12 VDC backup pump
8. (4) Cable ties

Customer required to purchase separately:

1. 12 VDC deep cycle battery – BCI Group 27, rated 85 – 140Ah, lead-acid or AGM
2. 115 VAC primary pump. Little Giant's 6EC-CIA-SFS or 10EC-CIA-SFS automatic pump is recommended
3. Check valve for 115 VAC pump
4. 1-1/2" pipe as needed
5. Fittings – As required

Figure 3

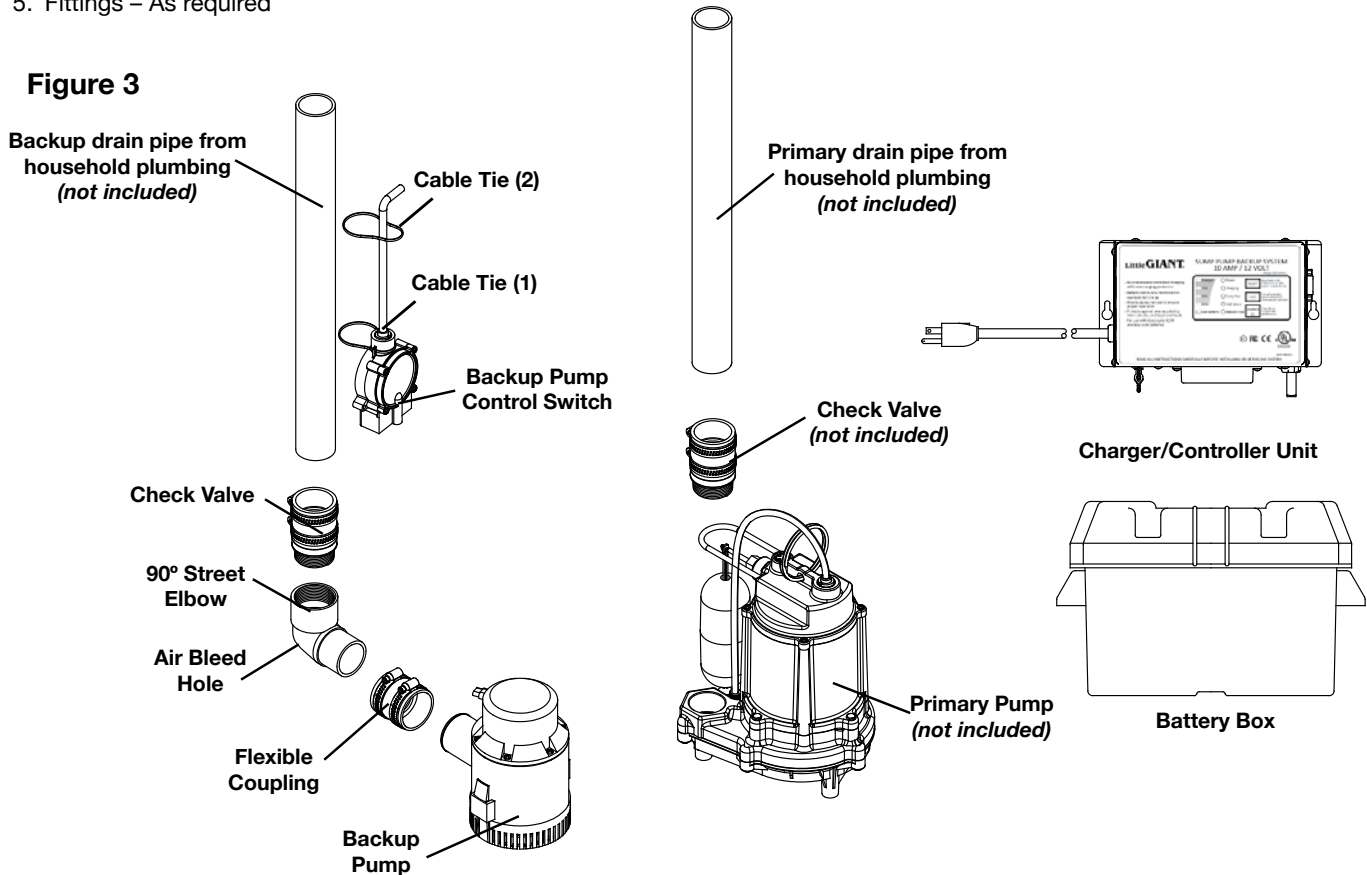

⚠ CAUTION Reduction of plumbing sizes from what is used for the discharges of the primary 115 VAC pump and 12 VDC pump can result in system under performance. Discharge piping that is of insufficient size can result in premature pump and/or system operation failure.

Figure 4

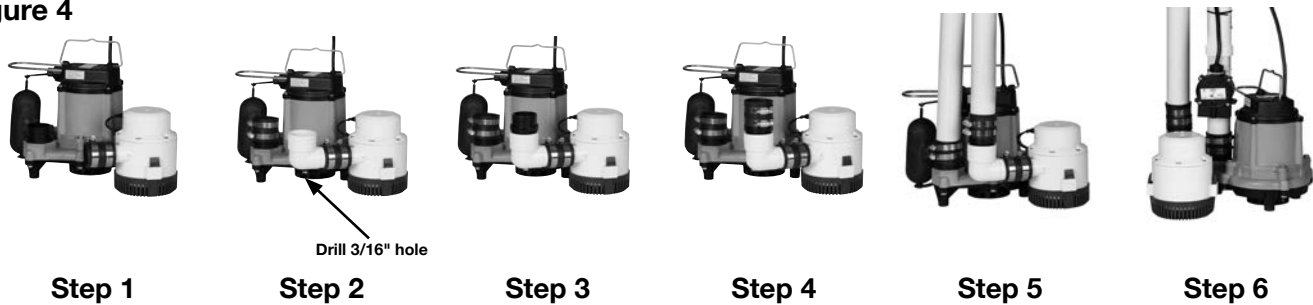

⚠ NOTICE: Do not glue any parts until the entire assembly, including primary pump, has been dry-assembled to verify fits. Fitting plumbing and routing wiring away from control floats will be much easier on a bench rather than working down inside a sump pit. (Fig. 4)

Step 1

- Install flexible coupling onto 12 VDC pump discharge.
- Position two hose clamps in the grooved recesses of flexible coupling installed on the 12 VDC pump.
- Tighten the flexible coupling's first hose clamp connection to securely fasten it to the 12 VDC pump discharge.
- Leave the hose clamp on the opposite end loose for the next plumbing piece.

Step 2

- A 3/16" diameter air bleed hole has been drilled in the 90° street elbow that is provided with the kit. (NOTICE: Air bleed hole must be located between the check valve and the 12 VDC pump to prevent the 12 VDC pump from air-locking.) The bleed hole is located so that the water flow through it will be at a downward angle to prevent splashing from the basin/pit.
- Slip 90° street elbow into the flexible coupling attached to the 12 VDC pump discharge, and tighten the hose clamp to secure elbow to the 12 VDC pump's discharge. (When properly installed the threaded elbow connection of the 90° street elbow should be facing straight up toward the top of the sump pit).

Step 3

⚠ NOTICE: A check valve is supplied and required for the backup pump's discharge plumbing. This check valve must be installed in the discharge plumbing between the backup pump and the connection joining the backup pump's discharge to the separate backup pump drain piping from the home.

- Apply PTFE tape to male threads of provided check valve.
- Thread PTFE taped end of check valve into 90° elbow.

Step 4

- Position two hose clamps in the grooved recesses of the flexible coupling on the check valve installed in the elbow.
- Tighten the lower hose clamp to secure the flexible coupling to the check valve body.
- Loosely tighten the upper hose clamp so it does not fall off. This clamp will be used to secure the check valve to the separate backup pump drain piping from the home.

Step 5

- Review the discharge plumbing of the 115 VAC primary pump.

⚠ NOTICE: A customer-supplied check valve is required in the discharge plumbing of the 115 VAC primary sump pump. This check valve must be installed in the discharge plumbing between the primary pump and the separate primary pump drain piping from the home. A 3/16" diameter air bleed hole must be located between the check valve and the 115 VAC pump to prevent the 115 VAC pump from air-locking. Locate the bleed hole so that the water flow through it will be at a downward angle to prevent splashing from the basin/pit.

- The 1-1/2" PVC pipe used in making the separate backup pump drain piping from the home must be cut so as to ensure that the 12 VDC backup pump rests flat on the floor of the sump basin when the plumbing is completed. Dry-fit the assembly to confirm prior to gluing (see Figure 4).
- Once dry-fit confirms that the 12 VDC backup pump rests flat on the sump basin floor and aligns with the separate backup pump drain piping from the home, secure all connections by applying approved waterproof adhesive to all necessary joints and confirm that all flexible coupling hose clamps are fully engaged with plumbing and fully tightened.

Step 6

- a. Cable ties (1) and (2) will be used to attach the 12 VDC pump control switch housing and power cord to the discharge pipe. Installing both cable ties to 12 VDC pump control switch is critical for proper operation of 12 VDC pump. (See Figure 3).
- b. Thread cable tie (1) through the eyelets on the 12 VDC pump control switch housing.
- c. Position the 12 VDC pump control switch on the discharge pipe such that cable tie (1) is 4" to 6" above the "ON" water level of the 115 VAC primary pump.
- d. Tighten cable tie (1) to secure the 12 VDC pump control switch to the discharge pipe.
- e. Install Cable Tie (2) around both the power cord of the 12 VDC pump control switch and the discharge pipe such that the power cord is securely routed away from any control floats.
- f. Use electrical tape to further secure the power cord of the 12 VDC pump control switch to the discharge pipe.

▲ NOTICE: RS-12 switch cord contains a breather tube. Be sure switch cord is not pinched so that breather tube is obstructed. Non-restrictive air flow in breather tube is required for proper RS-12 operation.

▲ NOTICE: For proper pump operation the exit point of all drain piping from the home must be lower, or sloping away, from the discharge plumbing's highest point. Improper water drainage can allow freezing within the line leading to system or component damage or failure.

▲ CAUTION Ensure all hose clamp connections and threaded connections are tight, and that all plumbing slip fit connections are properly glued prior to starting the sump pump system. Failure to do so can result in damage to pump system and/or cause property damage due to flooding.

▲ CAUTION Do not install or store the pump where it will be exposed to the weather or to temperatures below freezing or damage to the pump will occur.

Installation of Pre-assembled Backup System on a Common Discharge

(For 12 VDC Backup Systems SPBS-10HF-6 and SPBS-12HF-10 with included 115 VAC Primary Pump)



WARNING Comply with all national and local electrical and plumbing codes when installing this unit. Disconnect power from all electrical equipment housed within the sump system before working on or around the sump pump or battery backup system beginning with 115 VAC powered pumps, level switches, and charger controllers; followed by DC powered items. Includes all items such as pumps, level control switches, Charger/Controller Unit, and battery systems.

CAUTION Reduction of plumbing sizes from what is used for the discharges of the primary 115 V and 12 VDC can result in system under performance. Discharge piping that is of insufficient size can result in premature pump and/or system operation failure.

Included in the SPBS-10HF-6 and SPBS-12HF-10 kits: **Figure 5**

1. 12 VDC backup pump
2. 115 VAC primary pump
3. Battery charger/controller
4. Battery case (battery not included)
5. (1) 1-1/2" street elbow near 12 VDC pump
6. Coupling for 12 VDC pump discharge
7. Check valve for 12 VDC pump
8. Switch to control 12 VDC pump
9. Check valve for 115 VAC pump
10. Discharge pipe "wye" assembly connected to the 12 VDC pump and 115 VAC pump

Figure 5
Pre-assembled with Common Discharge Pipe "WYE" Assembly

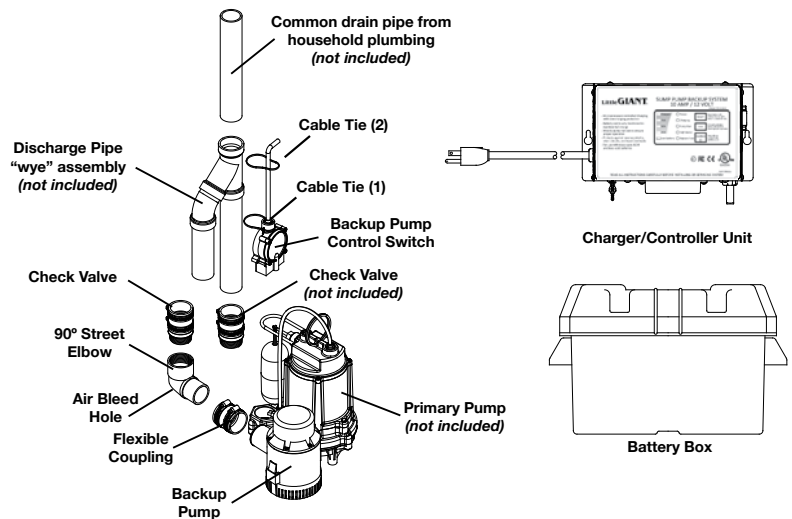

Customer required to purchase separately:

1. 12 VDC deep cycle battery – BCI Group 27, rated 85 – 140Ah, Lead-acid or AGM
2. Pipe and coupling or check valve (For connection to drain pipe from household plumbing to discharge pipe "wye" assembly)
3. Waterproof adhesive for plumbing connections

Step 1

- a. Remove all debris from the sump basin.
- b. Confirm that all flexible couplings and hose clamps are properly seated and tight on the PVC plumbing discharge piping that is part of the sump pump backup system.
- c. Place the sump pump backup system into the sump pit/basin. Support both pumps as the assembly is lowered into the basin. Do not use the PVC plumbing as a handle during this process as the connections might come loose.
- d. The connection from the discharge pipe "wye" assembly to the drain piping from the home must be made so as to ensure that both the 115 VAC primary pump and the 12 VDC backup pump rest flat on the floor of the sump basin when the plumbing is completely assembled and to align connection to the drain piping from the home. Dry-fit the assembly to confirm prior to gluing (see Figure 5).
- e. Once dry-fit confirms that both pumps rest flat on the sump basin floor and the wye assembly piping aligns with drain piping from the home, secure all connections by applying approved waterproof adhesive to all necessary joints and confirm that all flexible coupling hose clamps are fully engaged with plumbing and fully tightened.

CAUTION For proper pump operation the exit point of all drain piping from the home must be lower or sloping away, from the discharge plumbing's highest point. Improper water drainage can allow freezing within the line leading to system or component damage or failure.

CAUTION Ensure all hose clamp connections and threaded connections are tight and that all plumbing slip fit connections are properly glued prior to starting the sump pump system. Failure to do so can result in damage to pump system and/or cause property damage due to flooding.

CAUTION Do not install or store the pump where it will be exposed to the weather or to temperatures below freezing or damage to the pump will occur.

Charger/Controller Unit Installation

Little GIANT

SUMP PUMP BACKUP SYSTEM 10 AMP / 12 VOLT

Charger P/N 1210HF

- Microprocessor controlled charging with overcharging protection
- Battery continually monitored to maintain full charge
- Weekly pump run test to ensure proper operation
- Protects against reverse polarity, short circuits, and input overloads
- For use with deep cycle AGM and lead-acid batteries

<input type="checkbox"/> Charged	<input type="radio"/> Power	<input type="button" value="RESET"/>	Reset button will reset pump run light. System is ready for use.
<input type="checkbox"/> 75%	<input type="radio"/> Charging	<input type="button" value="TEST"/>	Manually activates pump and alarm to ensure proper operation
<input type="checkbox"/> 50%	<input type="radio"/> Pump Run	<input type="button" value="SILENCE"/>	Press silence to deactivate audible alarm
<input type="checkbox"/> 25%	<input type="radio"/> High Water		
<input type="checkbox"/> Low Battery	<input type="radio"/> Replace Fuse		



E302556

Form 986335

READ ALL INSTRUCTIONS CAREFULLY BEFORE INSTALLING OR SERVICING SYSTEM

Charger/Controller Electrical Ratings:

Input: 120 VAC, 3 Amp

Output (Maximum Charging Current):

- Model 1210HF: 12 VDC, 10 Amps
- Model 1212HF: 12VDC, 12 Amps

Use only with 12 VDC deep cycle battery rated 85 – 140Ah, lead-acid or AGM

⚠ WARNING Do not use in explosive atmospheres. Do not handle Charger/Controller Unit with wet hands or when standing on a wet or damp surface, or in water.

⚠ WARNING To reduce risk of electric shock which can result in personal injury, death or major property damage if ignored, be certain that the 115 VAC pump and the Charger/Controller Unit are connected to outlets protected by ground fault circuit interrupters (GFCI). Comply with all national and local electrical and plumbing codes when installing this unit. Do not use the same 115 VAC outlet for primary pump and Battery Charger/Controller Unit. Do not use extension cord.

⚠ WARNING A spark near the battery may cause an explosion. Always unplug Charger/Controller Unit prior to making connections to or disconnections from the battery. Take care to prevent accidental shorting across battery terminals during handling. Do not leave battery uncovered. Attach or strap cover securely on battery box when completing installation.

⚠ CAUTION The battery required to operate this unit contains acid and proper precautions must be taken when handling. Refer to battery manufacturer's safety guidelines. Failure to use proper personal protective equipment or electrical caution can result in hazards that will or can cause personal injury or major property damage if ignored.

⚠ CAUTION If a Carbon Monoxide (CO) sensor is installed near the battery backup system, battery, or Charger/Controller Unit, nuisance or false alarms could result. CO detectors should be a minimum of 15 feet from the systems. Refer to the manufacturer of CO detector for additional instructions or information.

⚠ CAUTION The backup pump relies on a sufficiently charged battery to operate the pump. The charger is designed to charge the battery and maintain charge level when the backup pump is not in use.

⚠ NOTICE: The Charger/Controller Unit emits an audible alarm when running the 12 VDC backup pump. An additional (not supplied in this kit) audible high water alarm on the sump system is recommended in any installations where property damage and/or personal injury might result from an inoperative sump system due to long term power outages, discharge line blockage, or any other reason.

Charger/Controller Unit Installation (continued)

Step 1 – Mounting the Charger/Controller Unit

▲ NOTICE: Do not expose the charger to excessive moisture. Install charger in a dry location. Indoor use only.

- Complete all plumbing, pump installation and pump control switch installation before installing the Charger/Controller Unit and before beginning work on the electrical connections to the Charger/Controller Unit or the battery.
- Charger/Controller Unit is designed to be installed on the wall in a visible location. The LED lights on the front of the charger as well as the switches on the face of the unit should be accessible and clearly visible.
- Select a location for the Charger/Controller Unit and the battery relative to the sump basin such that all the provided wiring will reach their respective connections with some slack remaining in the wiring. Locate the Charger/Controller Unit as far away from battery as the provided wiring permits. Charger/Controller Unit should not be installed directly over the battery. Gases from the battery will corrode and damage the Charger/Controller Unit. Battery should be positioned away from the wall to allow adequate ventilation of any fumes that are given off during charging.
- Use the Charger/Controller Unit's mounting holes to mark location on the wall for the included anchors and mounting screws.
- Install the Charger/Controller Unit on the wall using the included anchors and mounting screws, if suitable. Installer to confirm suitability of the mounting surface, method, and hardware.

▲ CAUTION The long ribs on the Charger/Controller Unit should be on top and the cords exit downward when the Charger/Controller Unit is installed on the wall. The long ribs are heat sinks and may become hot in normal operation. Do not allow these surfaces to become covered in combustible materials and do not touch these during normal operation. All combustible materials should be kept away from the hot surfaces of the Charger/Controller Unit, and the Charger/Controller Unit should be well away from other sources of heat such as space heaters, radiators, boilers, furnace etc.

▲ CAUTION The Charger/Controller Unit has a 115 VAC power supply cord, a cord for connecting to the battery, and a cord for connecting to the pump cord. If any of the cords are damaged, or the Charger/Controller Unit itself becomes damaged, immediately un-plug the Charger/Controller Unit and remove it from service. Always disconnect 115 VAC power supply cord before doing any service of the product and allow the Charger/Controller Unit to cool. Disconnect 115 VAC before disconnecting battery leads.

▲ CAUTION Power is being supplied to the 12 VDC backup pump when the “Water High” indicator is on or the test button is held down. Do not disconnect the pump cable while power is going to the 12 VDC backup pump.

▲ CAUTION There are no serviceable parts inside the Charger/Controller Unit body. Do not open or attempt any repairs inside the Charger/Controller Unit body. Hazardous voltage exists inside the enclosure.

▲ CAUTION Do not try to charge non rechargeable batteries.

▲ NOTICE: 12 VDC backup pump fuse is located on the bottom of the charger. Replacement fuse should be automotive type 32 V, 20A type ATC.

Figure 6

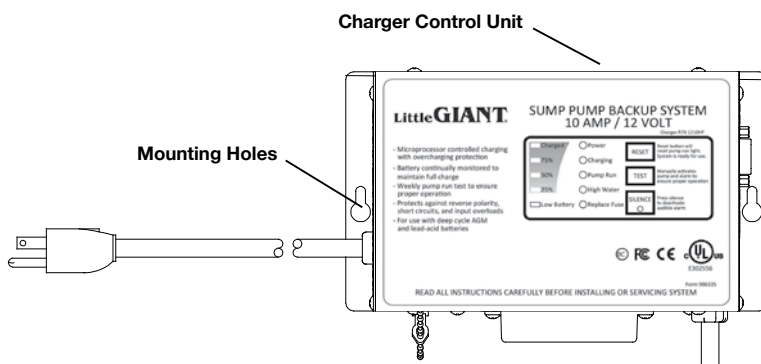
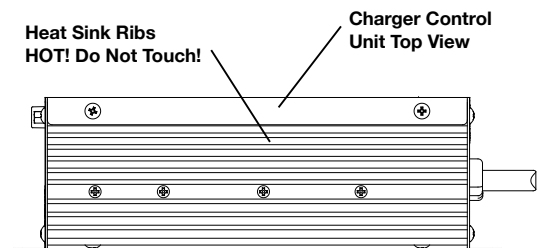

Figure 7



Charger/Controller Unit Installation (continued)

Step 2 – Electrical Connections



WARNING Comply with all national and local electrical and plumbing codes when installing this unit. Disconnect power from all electrical equipment housed within the sump system before working on or around the sump pump or battery backup system beginning with 115 VAC powered pumps, level switches, and charger controllers; followed by DC powered items. Includes all items such as pumps, level control switches, Charger/Controller Unit, and battery systems.

NOTICE: Installation of the 115 VAC electrical supply circuit to the battery charger is to be done by a certified licensed electrician in accordance with national and local codes.

- Verify that Charger/Controller Unit is not connected to power supply source. Remove plastic cover on the bottom of Charger/Controller Unit. Connect the terminals from the control switch cord to the (2) male tab terminals on the Charger/Controller Unit marked "SWITCH". Reinstall plastic cover.
- Verify that all plumbing is complete per instructions.
- Connect the terminals from the backup pump cord to the terminals from the Charger/Controller Unit cord for the pump being careful to match the correct polarity.
- Connect Charger/Controller Unit to the battery. Be certain to connect positive terminal of the Charger/Controller Unit cord for the battery to the positive post of the battery. Correct polarity is marked on the cord as well as the battery. In case of reverse connection the Charger/Controller Unit will sound an alarm when 115 VAC power is supplied to the Charger/Controller Unit.
- Do not connect this Charger/Controller Unit to the same circuit as is used for the primary pump. The AC outlet used for the Charger/Controller Unit requires separate 3A, 115 VAC circuit.
- Verify that all wiring is per instructions. Once all plumbing and electrical connections are complete and verified, plug 115 VAC power supply cord for the Charger/Controller Unit into a 115 VAC electrical outlet.
- Press the "test switch" and observe that the 12 VDC pump is running.
- Review Charger/Controller Operation section.
- Perform testing per the Sump System Operation Testing Section.

NOTICE: The Charger/Controller Unit has provisions for connection to auxiliary Class 2 alarm system or phone dialer (not included). This circuit is normally open and closes when the 12 VDC pump switch circuit closes. Once closed, the circuit remains closed until "RESET" button is pushed on the Charger/Controller Unit. This circuit requires Class 2 wiring. If used, route this wiring away from the Charger/Controller Unit power supply cord, battery cord, and pump cord. Follow manufacturer's instructions for dialer or alarm system.

Charger/Controller Unit Electrical Connections

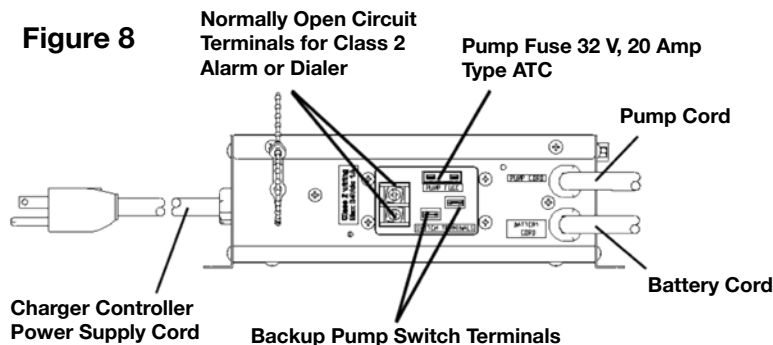

Wiring Diagram

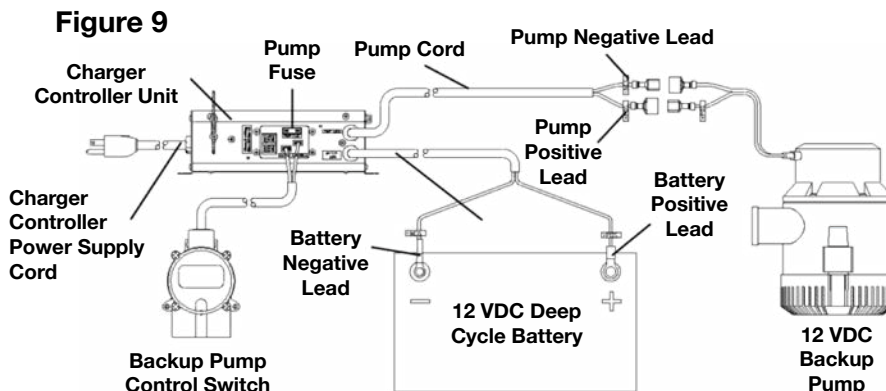

Charger/Controller Unit Operation

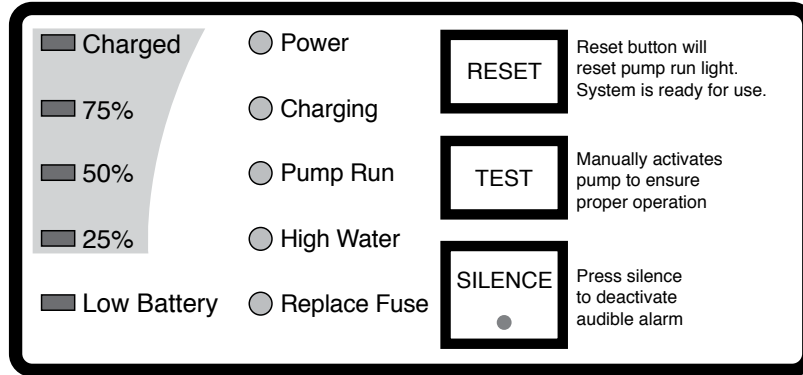

Figure 10

1. The upper left side of the face plate provides an approximation of the battery charge. In normal operation the charge will typically show 25%, 50%, and 75% lights lit. When these are lit the system is indicating the approximate power available to the pump. A maintenance charge to the battery is happening between “75% and Charged” which means the charger is maintaining the maximum capacity the battery is capable of producing when “75% and Charged” indicators are lit.
2. The green “Charging” indicator is lit when the battery is charging. When the “Low Battery” indicator is lit the 12 VDC backup pump will not function properly. A new fully charged 90AH deep cycle battery will allow the 12 VDC backup pump to operate for about 1 day assuming that the pump has a cycle of 1 minute on and 4 minutes off. The time you have will depend upon the age of the battery, the charge in the battery, and how often the 12 VDC pump must run. An older battery will provide less time. The 115 VAC primary pump must be made operational in the time you have before the “Low Battery” light comes on. For the battery to begin recharging, 12 VDC pump must not be drawing power from the battery. A fully discharged 90AH battery requires approximately 9 hours to fully charge. Batteries must be re-charged soon after being discharged or possible damage to the battery will occur.
3. The red “Power” indicator will come on when the 115 VAC plug is plugged into power and power is available. If no power is available then the light does not light and the charger will not charge the battery.
4. The “Pump Run” indicator comes on when the switch that controls the battery backup pump first activates. The indicator will remain on until “RESET” button is pushed.
5. The “High Water” indicator comes on when the pump is actively trying to remove water from the sump. The switch for the 12 VDC pump is in the on position and providing power to the 12 VDC pump when lit. When switch is in off position the indicator is off and no power is going to the pump.
6. The “Fuse” indicator is lit when the Fuse has failed. Replace with automotive type 32 V, 20A type ATC fuse, on the bottom of the charger.
7. The “RESET” switch will reset the system if the switch is no longer activated. System will then check to verify everything is normal and if so, system re-sets. If any problems such as switch still activated, this indicator will again be lit, the audible alarm will sound and the battery status will be verified.
8. The “Test” button allows you to manually verify that pump operates without having to activate the switch. Press and hold the button and you should hear the pump operating.
9. The “Silence” button turns off the audible alarm.

ITEM	FUNCTION	DESCRIPTION / OPERATIONS
Charged – 75%	LED Indicators	Indicates battery is between 75% and Fully Charged. Charger is in maintenance mode to maintain highest battery capacity possible.
50%	LED Indicator	Indicates the battery level based on a voltage level
25%	LED Indicator	Indicates the battery level based on a voltage level
Low Battery	LED Indicator	Indicates battery is critically discharged, pump will not work
Power	LED Indicator	Indicates AC power is present
Charging	LED Indicator	Indicates battery is receiving current from the charger
Pump Run	LED Indicator	Indicates the pump ran and system has not been re-set
High Water	LED Indicator	Indicates the switch contact is closed
Replace Fuse	LED Indicator	Indicates the pump circuit has no power & 20A fuse must be replaced
RESET	Button/Key	This switch will reset system
TEST	Button/Key	Depress & hold this switch allows you manually test 12 VDC pump.
SILENCE	Button/Key	This switch turns off the buzzer and a yellow silence indicator comes on

Sump System Operation Testing

⚠ WARNING Always disconnect the electrical power before touching the pump or discharge when water is present in the area of the pump. Failure to do so can result in hazardous electrical shock.

⚠ CAUTION Ensure all hose clamp connections and threaded connections are tight and that all plumbing slip fit connections are properly glued prior to starting the sump pump system. Failure to do so can result in damage to pump system and/or cause property damage due to flooding.

⚠ CAUTION Do not allow the pump to run dry or damage to the pump will occur. Do not allow the sump basin to overflow during this testing.

Step 1

- a. Verify that all wiring is per instructions and that primary pump and controller are connected to power.
 - i. The red "Power" indicator light should be lit on the Charger/Controller Unit.

Step 2

- a. Run water into the sump basin until the primary pump is activated.
 - i. Do not attempt to run the pump without water; this could result in permanent damage to the pump.
 - ii. Confirm that primary pump and its control switch are functioning as intended.
 - iii. Confirm that ON-OFF levels are within specification and confirm that no potential obstructions exist that could inhibit switch operation.
 - iv. Confirm that there are no leaks in the primary pump discharge plumbing and main home drain pipe plumbing.
 - a) It is normal for a stream of water to spray from the air bleed hole in the primary pump's plumbing. Confirm that this spray is captured within the sump basin.

Step 3

- a. After primary pump function has been confirmed, disconnect power to primary pump.
 - i. This is typically done at an electrical connection box or a plug receptacle.

Step 4

- a. Run water into the sump basin until the backup pump is activated.
 - i. Do not attempt to run the pump without water; this could result in permanent damage to the pump.
 - ii. Confirm that backup pump and its control switch are functioning as intended.
 - iii. Confirm that the Charger/Controller Unit emits an audible alarm when running the backup pump.
 - a) Press SILENCE button on the Charger/Controller Unit to silence the audible alarm.
 - iv. Confirm that ON-OFF levels are within specification and confirm that no potential obstructions exist that could inhibit switch operation.
 - a) The RS-12 switch will activate the 12 VDC backup pump when water is approximately 6 inches above the bottom of the RS-12 switch.
 - v. Confirm that there are no leaks in the backup pump discharge plumbing and main home drain pipe plumbing.
 - a) It is normal for a stream of water to spray from the air bleed hole in the backup pump's plumbing. Confirm that this spray is captured within the sump basin.

Step 5

- a. After backup pump function has been confirmed, disconnect power to the Charger/Controller Unit to confirm proper battery function.
 - i. This is typically done at an electrical connection box or a plug receptacle.

Step 6

- a. Run water into the sump basin until the backup pump is activated.
 - i. Confirm that backup pump and its control switch are functioning as intended.
 - ii. Confirm that the Charger/Controller Unit emits an audible alarm when running the backup pump.
 - a) Press SILENCE button on the Charger/Controller Unit to silence the audible alarm.

Step 7

- a. After primary pump, backup pump and Charger/Controller Unit function has been confirmed, reconnect power to the Charger/Controller Unit and the primary pump
 - i. Confirm that primary pump activates and evacuate the remaining water from the sump basin down to the normal OFF level of the primary pump. Primary pump should deactivate when the OFF level is reached.

Step 8

- a. Charger/Controller Unit faceplate indicators should provide status of battery's charge.
 - i. See Charger/Controller Unit Operation section for details.

Step 9

- a. Confirm that battery is in working condition according to the battery manufacturer's instructions and is fully charged.

Step 10

- a. The primary and backup pumps are now ready for operation.

System Maintenance:



⚠ WARNING Disconnect power from all electrical equipment housed within the sump system before working on or around the sump pump or battery backup system beginning with 115 VAC powered pumps, level switches, and charger controllers; followed by DC powered items. Includes all items such as pumps, level control switches, Charger/Controller Unit, and battery systems.

⚠ CAUTION The backup pump and the primary pump are designed for pumping clear water only. Do not use the pumps in applications where effluent (grey water), sewage or any other debris (gravel, sand, floating debris, etc.) is present.

⚠ CAUTION Do not allow the sump basin to overflow during this maintenance.

⚠ NOTICE: Inspect and test the sump system condition and operation every 3 months (more frequently in heavy use applications).

Step 1

- a. Refer to battery manufacturer's instructions to confirm that battery is in working condition and is fully charged.
 - i. Clean any corrosion from the battery posts or pump terminals.

Step 2

- a. Remove all debris (gravel, sand, floating debris, etc.) from the sump basin.
- b. Review sump system components for any build-up (minerals, etc.) that would inhibit functionality of the components.
 - i. If significant, remove build-up or replace affected components.

Step 3

- a. Confirm that all flexible coupling hose clamps are fully engaged with plumbing and fully tightened.

Step 4

- a. Test operation of the sump system following the instructions outlined in the Sump System Operation Testing section of this manual.

Troubleshooting

TROUBLESHOOTING INFORMATION

PROBLEM	PROBABLE CAUSES	115 V	12 V	CORRECTIVE ACTION
Pump does not turn on or turn off.	Bad connection	X	X	Plug-in pump
	Blown fuse		X	Turn on circuit breaker or replace fuse
	Bad battery		X	Replace battery
	Pump impeller obstructed	X	X	Pull pump and clean
	Pump control switch	X	X	Replace switch
Pump does not deliver rated capacity.	Low battery		X	When power is restored, the charger will charge the battery
	Check valve installed backwards	X	X	Check flow indication arrow on check valve body to ensure it is installed properly
	Low voltage, speed too slow	X	X	Check for proper supply voltage to make certain it corresponds to name plate voltage.
	Impeller or discharge pipe is clogged	X	X	Pull pump and clean. Check pipe for scale or corrosion
Pump cycles continually.	Defective battery		X	Replace battery
	No check valve in long discharge pipe allowing liquid to drain back into sump.	X	X	Install a check valve in discharge line
	Check valve leaking	X	X	Inspect check valve for correct operation
	Sump pit too small for inflow	X	X	Install larger sump pit
Pump will not shut off. NOTE: Before troubleshooting automatic control, check to see that pump operates on manual control. To do this, create slight vacuum on breather tube (near plug), then close off tube with thumb, plug into wall outlet. If pump works, proceed to check switch; if not, fault is in pump or power supply.	Pump control switch	X	X	Replace switch
	Plugged vent tube		X	Clear vent tube of any obstruction
	Dirt or sediment lodged between retainer ring and rubber diaphragm causing contacts to remain closed		X	Clean area around rubber diaphragm
	Pump is air locked	X	X	Shut power off for approximately 1 minute, then restart. Repeat several times to clear air from pump. If system includes a check valve, a 3/16" hole should be drilled in the discharge pipe between the pump discharge and the check valve.
	Liquid inflow matches pump capacity	X	X	Larger pump required
Pump runs but does not discharge liquid.	Check valve installed backwards	X	X	Check flow indicating arrow on check valve body to ensure it is installed properly.
	Check valve stuck or plugged	X	X	Remove check valve and inspect for proper operation
	Lift too high for pump	X	X	Check pump performance as compared to the vertical distance needed to evacuate the sump water
	Inlet to impeller plugged	X	X	Pull pump and clean
	Pump is air locked	X	X	Shut power off for approximately 1 minute, then restart. Repeat several times to clear air from pump. If system includes a check valve, a 3/16" hole should be drilled in the discharge pipe between the pump discharge and the check valve.

LIMITED WARRANTY

THIS WARRANTY SETS FORTH THE COMPANY'S SOLE OBLIGATION AND PURCHASER'S EXCLUSIVE REMEDY FOR DEFECTIVE PRODUCT.

Franklin Electric Company, Inc. and its subsidiaries (hereafter "the Company") warrants that the products accompanied by this warranty are free from defects in materials or workmanship of the Company that exist at the time of sale by the Company and which occur or exist within the applicable warranty period. Any distributor, sub-distributor, recipient, end-user and/or consumer agrees that by accepting the receipt of the products, the distributor, sub-distributor, recipient, end user and/or consumer expressly agree to be bound by the terms of the warranty set forth herein.

I. Applicable Warranty Period

The products accompanied by this warranty shall be covered by this Limited Warranty for a period of 24 months from the date of original purchase by the consumer. In the absence of suitable proof of purchase date, the warranty period of this product will begin to run on the product's date of manufacture.

II. Instructions Applicable to this Limited Warranty

1. Consumers wishing to submit a warranty claim must return the products accompanied by this warranty to the point of purchase for warranty consideration.
2. Upon discovery of a defect, any personal injury, property damage or any other type of resulting damage, if applicable, shall be reasonably mitigated to the extent possible.
3. At its discretion, the Company may inspect products either at its facilities or in the field, and after determination of a warranty claim, will, at its option, repair or replace defective parts. Repaired or replaced parts will be returned freight prepaid by the Company.
4. This warranty policy does not cover any labor or shipping charges. The Company shall not be liable for any costs or charges attributable to any product testing, maintenance, installation, repair or removal, or for any tools, supplies, or equipment needed to install, repair, or remove any product.

III. Limitations Applicable to this Limited Warranty

THIS WARRANTY DOES NOT APPLY TO ANY OF THE FOLLOWING:

1. Any product that is not installed, applied, maintained, and used in accordance with the Company's published instructions, applicable codes, applicable ordinances and/or with generally accepted industry standards.
2. Any product that has been subject to misuse, misapplication, neglect, alteration, accident, abuse, tampering, acts of God (including lightning), acts of terrorism, acts of war, fire, improper storage or installation, improper use, improper maintenance or repair, damage or casualty, or to an excess of the recommended maximums as set forth in the product instructions.
3. Any product that is operated with any accessory, equipment, component, or part not specifically approved by the Company.
4. Use of replacement parts not sold by the Company, the unauthorized addition of non-Company products to other Company products, and the unauthorized alteration of Company products.
5. Products damaged by normal wear and tear, normal maintenance services and the parts used in connection with such service, or any other conditions beyond the control of the Company.
6. Any product that has been used for purposes other than those for which it was designed and manufactured.
7. Any use of the product where installation instructions and/or instructions for use were not followed.

The Company reserves the right at any time, and from time to time, to make changes in the design and/or improvements upon its product without thereby imposing any obligation upon itself to make corresponding changes or improvements in or upon its products already manufactured and/or previously sold. The Company further reserves the right to substitute parts or components of substantially equal quality in any warranty service required by operation of this Limited Warranty.

This written Limited Warranty is the entire warranty authorized and offered by the Company. There are no warranties or representations beyond those expressed in this document.

THIS WARRANTY AND REMEDY IS IN LIEU OF ALL OTHER WARRANTIES AND REMEDIES INCLUDING, WITHOUT LIMITATION,

WARRANTIES OF MERCHANTABILITY AND/OR FITNESS FOR A PARTICULAR PURPOSE, WHICH ARE HEREBY SPECIFICALLY DISCLAIMED AND EXPRESSLY EXCLUDED. CORRECTION OF NON-CONFORMITIES, IN THE MANNER AND FOR THE PERIOD OF TIME AS SET FORTH ABOVE, SHALL CONSTITUTE FULFILLMENT OF ALL LIABILITY OF THE COMPANY TO THE PURCHASER WHETHER BASED ON CONTRACT, NEGLIGENCE, OR OTHERWISE.

THE COMPANY SHALL NOT BE LIABLE FOR INCIDENTAL, CONSEQUENTIAL OR SPECIAL DAMAGES SUCH AS, BUT NOT LIMITED TO:

DAMAGE TO OR LOSS OF OTHER PROPERTY OR EQUIPMENT, LOSS OF USE OF EQUIPMENT, FACILITIES OR SERVICE, LOSS OF PROFIT OR SALES, COST OF PURCHASES OR REPLACEMENT GOODS, CLAIMS OF CUSTOMERS OF THE PURCHASER, FAILURE TO WARN AND/OR INSTRUCT, LOSS OF OTHER PRODUCTS, OR COSTS OF ENVIRONMENTAL REMEDIATION, OR DIMINUTION IN PROPERTY VALUE. THE REMEDIES OF THE PURCHASER SET FORTH HEREIN ARE EXCLUSIVE, AND THE LIABILITY OF THE COMPANY SHALL NOT, EXCEPT AS EXPRESSLY PROVIDED HEREIN, EXCEED THE PRICE OF THE PRODUCTS UPON WHICH SUCH LIABILITY IS BASED. DAMAGES AS SET FORTH IN THIS PARAGRAPH SHALL BE REASONABLY MITIGATED TO THE EXTENT POSSIBLE. THIS PARAGRAPH SHALL ALSO APPLY TO ALL DAMAGES RESULTING FROM CONDITIONS SET FORTH IN SECTION III ABOVE AND (1) DEFECTS IN PRODUCT PROTOTYPES OR REPLACEMENT PART PROTOTYPES THAT HAVE NOT BEEN PUT INTO PRODUCTION, CIRCULATED AND SOLD BY THE COMPANY, AND/OR (2) DEFECTS THAT WERE NOT FOUND AT THE TIME OF SALE DUE TO SCIENTIFIC AND TECHNOLOGICAL REASONS.

This Limited Warranty gives you specific legal rights. You may have other rights, which vary according to the applicable laws and regulations. Where any term of this warranty is prohibited by such laws, it shall be null and void, but the remainder of this warranty shall remain in full force and effect.

DISCLAIMER: Any oral statements about the product made by the seller, the Company, the representatives or any other parties, do not constitute warranties, shall not be relied upon by the user, and are not part of the contract for sale. Seller's and the Company's only obligation, and buyer's only remedy, shall be the replacement and/or repair by the Company of the product as described above. Before using, the user shall determine the suitability of the product for his intended use, and user assumes all risk and liability whatsoever in connection therewith.



For technical assistance, please contact 800.701.7894

www.littlegiant.com
lgnet@fele.com



Form 998912
Rev. 0
08.15

LittleGIANT[®]

Franklin Electric Co., Inc.
Oklahoma City, OK 73157-2010
Phone: 1.800.701.7894
Fax: 1.405.228.1561