



User Guide

Smart Wi-Fi Light Switch, Dimmer
KS220

Contents

About This Guide	1
Introduction	2
Set Up Your Switch via Tapo	9
Set Up Your Switch via HomeKit.....	10
Main Device Controls	12
Manage Device Settings	15
Reset Your Smart Switch	18
Authentication	19

About This Guide

This guide provides a brief introduction to Smart Wi-Fi Dimmer Switch and regulatory information.

Features available in Kasa Smart may vary by model. All images, steps, and descriptions in this guide are only examples and may not reflect your actual Kasa Smart experience.

Conventions

In this guide, the following convention is used:

Convention	Description
Teal	Key information appears in teal, including management page text such as menus, items, buttons and so on.
<u>Underline</u>	Hyperlinks are in teal and underlined. You can click to redirect to a website.

More Info

- Specifications can be found on the product page at <https://www.tp-link.com>.
- Our Technical Support contact information can be found at the Help center of the Kasa Smart app and the Contact Technical Support page at <https://www.tp-link.com/support>.

Introduction

Control your home lighting from anywhere, anytime with the Kasa Smart app. Easily dim your lights from 1% to 100%.



- **Apple HomeKit Supported** - Integrate your devices easily into your Apple ecosystem and control them using the Apple Home app and Siri on your iPhone, iPad, Apple Watch, HomePod, or Mac.
- **Smart Dimming** - Adjust your home's brightness freely using the Kasa Smart app, dimmer buttons, and voice commands via Alexa or Google Assistant.
- **Brightness Control** - Control the brightness of your lights to set the perfect ambiance for any activity.
- **Voice Control** - Use simple voice commands to control the lights with Alexa or Google Assistant.
- **Control From Anywhere** - Control your lights from anywhere using the Kasa Smart app.
- **Set Schedules** - Set your dimmer to automatically turn on and off while you're home or away.
- **Group & Scene** - Group your smart switch with other smart devices to control them all at once. Set custom scenes to match any occasion like waking up.
- **Away Mode** - Set your smart dimmer switch to turn lights on and off at random intervals to give the appearance you're home even while you're away.
- **No Hub Required** - The Kasa Smart Wi-Fi Light Switch connects to your home's secure Wi-Fi network. No need for a hub or extra equipment.

Appearance

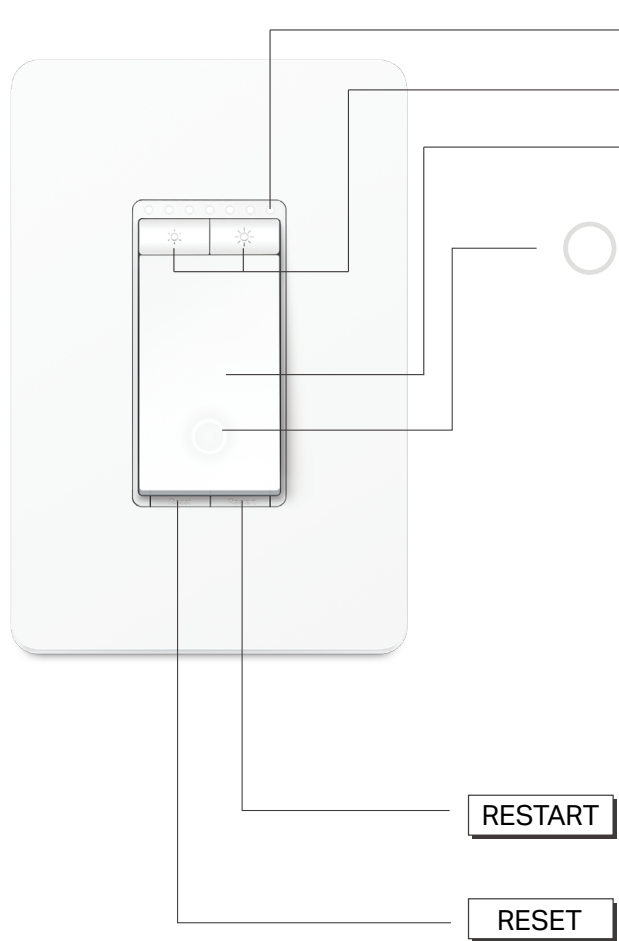

Light Indicators: Indicate light brightness.

Press to decrease/increase light brightness.

Switch Button: Press to turn on/off the switch.

Solid Amber: Starting up.

Blinking amber & green: Ready for setup; Resetting Wi-Fi.

Blinking Green: Connecting to Wi-Fi.

Solid Green: Lit up for about 30 seconds when successfully connected to the Wi-Fi network, then turns off.

Blinking Amber: Resetting.

Solid Red: No Wi-Fi connection.

White: Lit up when the light is switched OFF to show the Smart Switch location in the dark.

RESTART

Press to reboot the Smart Switch.

RESET

Press & hold for about **5s**: Reset Wi-Fi while keeping other settings
Press & hold for about **10s**: Restore factory default settings.

Detach the Wallplate

Carefully insert a flat-bladed screw driver the opening at the bottom of the wallplate and pull forward to remove the wallplate.

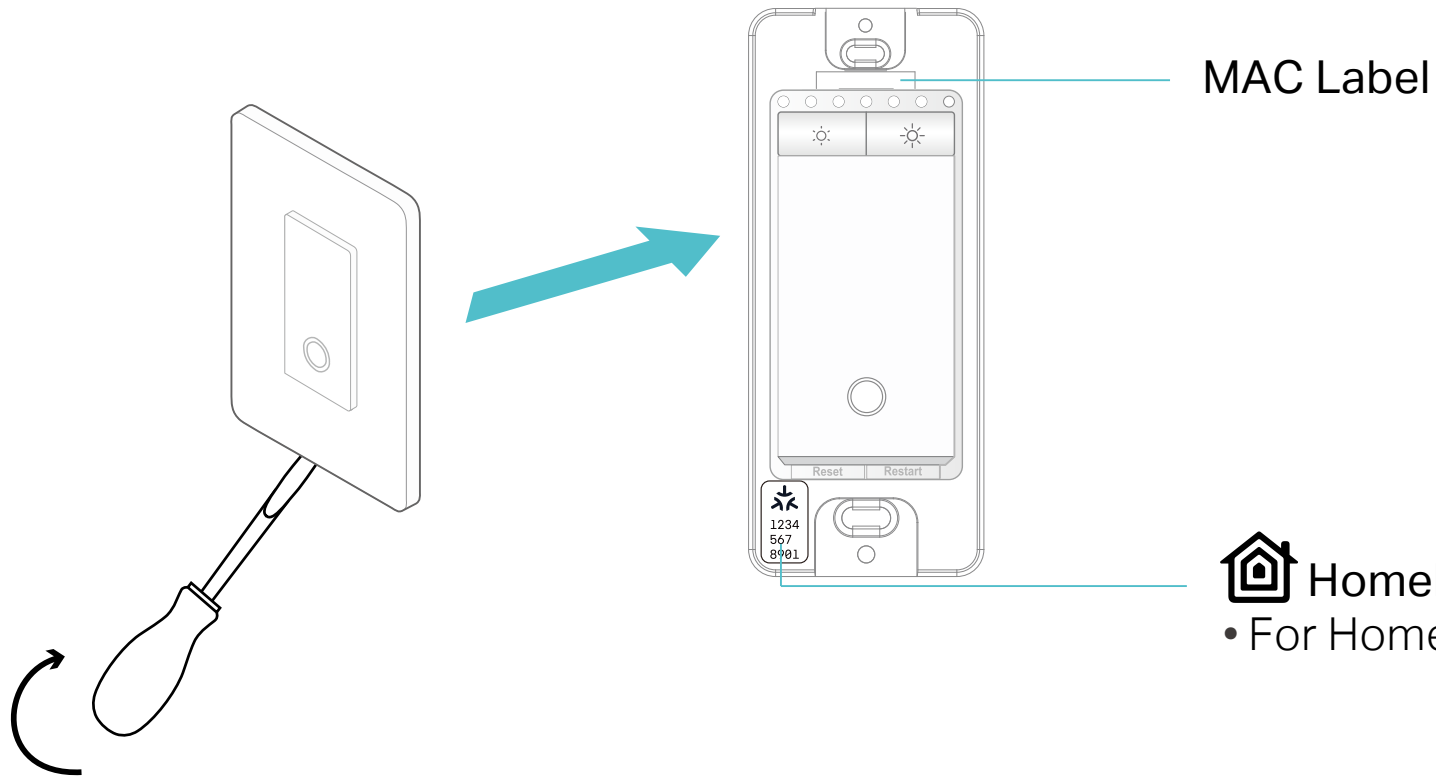

*Images may differ from your actual product.

Note: You can find another Homekit setup code label in the package and stick it anywhere you like as needed for Homekit setup.

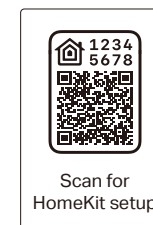

Wire Your Switch

Follow the steps below to wire your Smart Wi-Fi Light Switch. If you are not familiar with basic electrical wiring, please consult an electrician.

Before You Start

1. Prepare Basic knowledge of Wiring

- **Ground:** Usually green or copper.
- **Neutral:** Usually white, not connected to the dumb switch.
- **Line:** Usually black and coming from the circuit breaker.
- **Load:** Usually black. One end is connected to the light.

Note: If you are unsure, consult a qualified electrician.

2. Prepare Your Tools

Prepare a philips and slotted screwdriver, pliers, wire strippers and a voltage detector.

3. Check Wi-Fi Strength

Make sure your switch is in a area with strong Wi-Fi signal.

Wire Your Switch

Step 1. Turn Off Power and Remove the Wallplate

Turn off the circuit breaker. Then remove the old wallplate of the wall switch and label the wires.



CAUTION

Risk of Electric Shocks - High Voltage - Disconnect power supply at the circuit breaker before servicing.



MISE EN GARDE

Risque d'électrocution - Haute tension: débranchez l'alimentation électrique au niveau du disjoncteur avant l'utiliser.

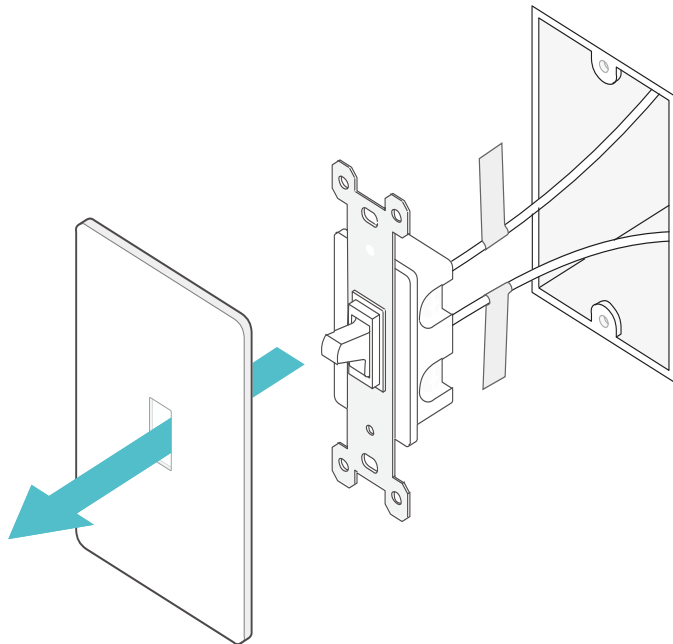

Step 2. Expose Your Switch Wiring

Disconnect wires from the old switch.

Step 3. Identify and Label the Line & Load Wires

- 1) Turn on the circuit breaker. Use a voltage detector to identify the energized wire (**Line** wire).
- 2) Turn off the circuit breaker. Label the **Line** and **Load** wires.

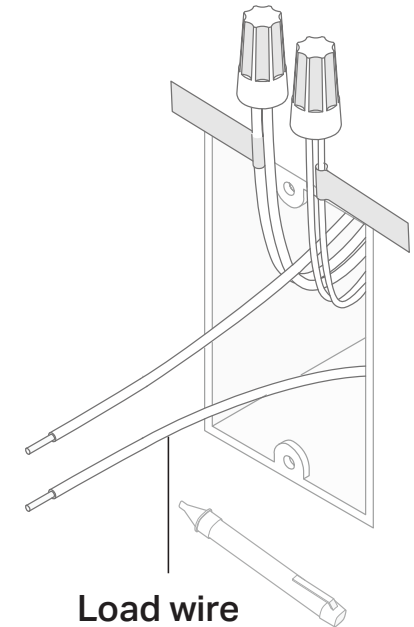
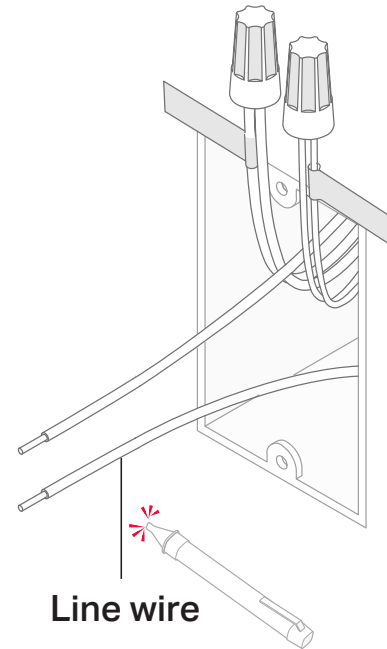

Step 4. Label Ground & Neutral Wires and Connect the Wires

Connect the wires as the diagram below.

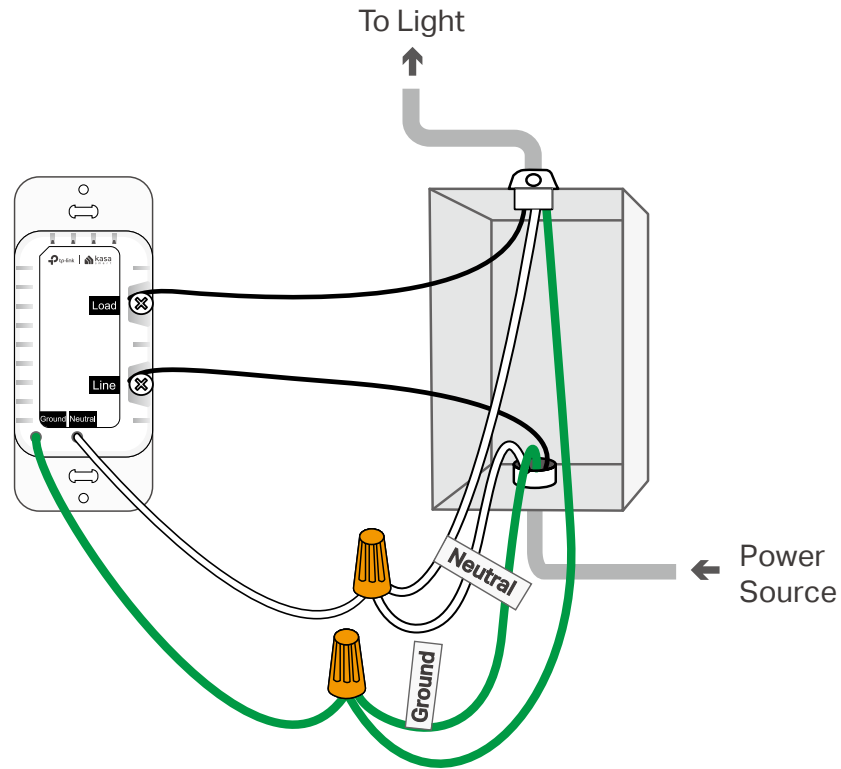

Step 5. Install Your Smart Switch

Gently fold all of the wires back into the wall box. Line up the switch with the mounting holes. Secure it with screws.

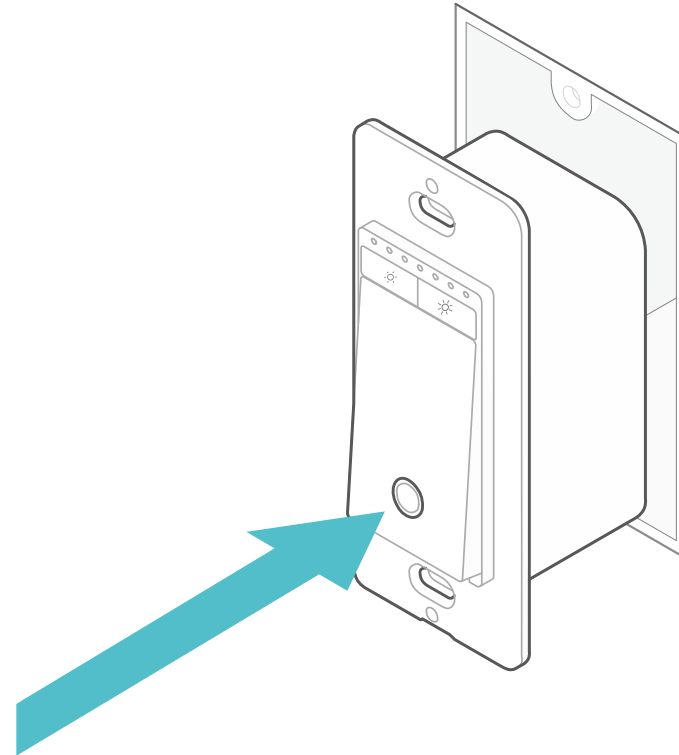

Step 6. Attach the Wallplate and Turn on Power

Attach the wallplate and turn on the circuit breaker. Then the wiring is finished.

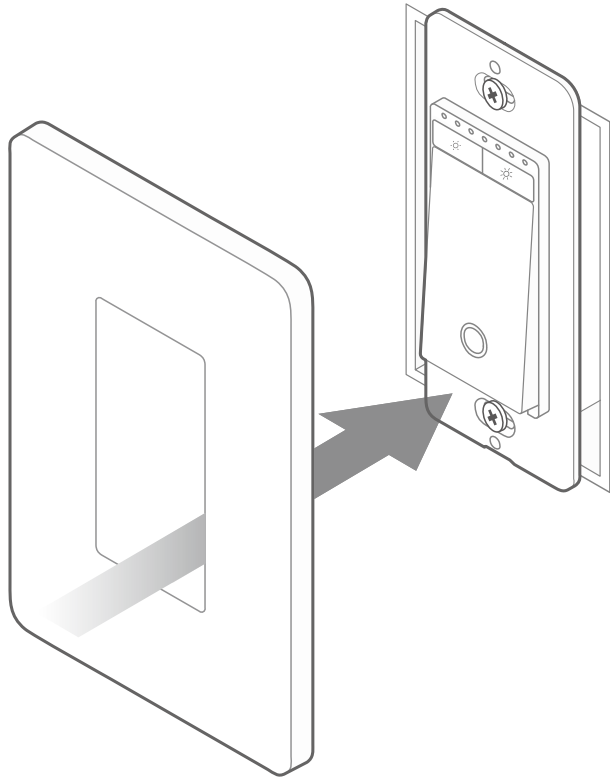

Set Up Your Switch via Tapo

Follow the steps below to set up your Smart Light Switch via [Kasa Smart](#) app.

1. Download and install Kasa app

Go to Google Play or the App Store or scan the QR code below to download the [Kasa Smart](#) app on your Android or iOS smartphone or tablet.



OR

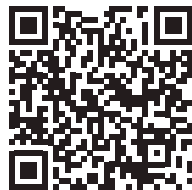

2. Log in or sign up with TP-Link ID

Open the app. Use your TP-Link ID to log in.

If you don't have a TP-Link ID, tap [Create Account](#) and the Kasa Smart app will guide you through the rest.

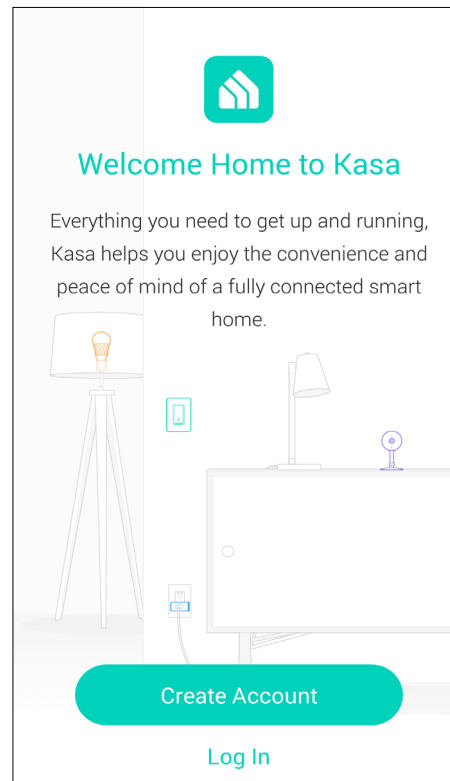

3. Add Device

Tap the + button in the Kasa Smart app, select [Smart Switches](#) > [Homekit Smart Dimmer](#), and then follow step-by-step app instructions to complete the installation and setup.

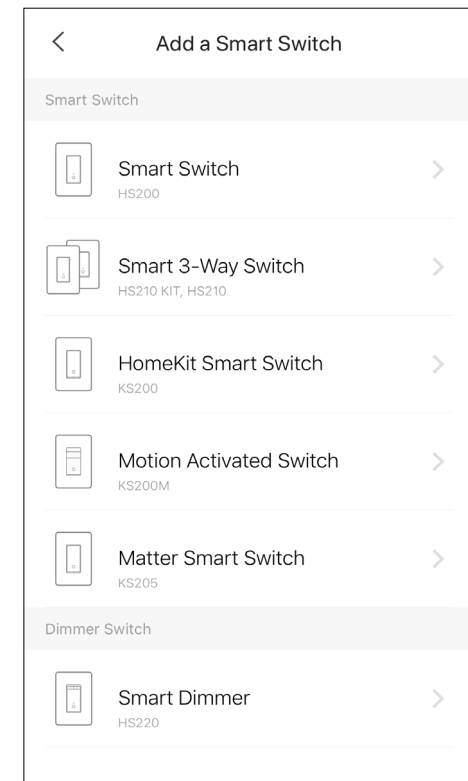

Set Up Your Switch via HomeKit

Before You Start

- Your iPhone/iPad should be connected to a stable 2.4 GHz Wi-Fi network with internet access.
 - Ensure your iPhone/iPad, HomeKit device, and Apple home hub* (if any) are connected to the same Wi-Fi network.
- *The hub like HomePod, HomePod mini, and Apple TV helps control your HomeKit devices remotely, share the devices with others, and automate your devices to do tasks for you.
- To control the HomeKit-enabled device in the Apple Home app, the latest iOS or iPadOS version is highly recommended.
 - Find the HomeKit QR code or numeric code on your device or in its packaging. After setup, you can save the code in Device Settings in the Kasa Smart app.

How to Set Up?

1. Factory reset your Smart Switch.
2. Open the Apple Home app.

If you have added your smart device to the Kasa Smart app, you can go to **Device Settings > Device Info** in the app to find the HomeKit setup code and add the device to the Home app.

3. Scan the HomeKit QR code or enter the provided numeric setup code.
4. Follow the instructions in the app to complete setup.

Failed to Set Up?

- Factory reset the Smart Switch and restart your phone. Then try again.
- Move your iPhone/iPad and the smart device closer to the router to get a stronger Wi-Fi signal.
- HomeKit setup will be disabled in 10 minutes since the smart device is powered on. You can power off your Smart Switch, then power it on and try again.
- Creating a new home in the Home app can greatly help set up your smart device.
- You can visit <https://www.tp-link.com/support/faq/3390/> or scan the QR code below for more troubleshooting instructions.



Scan QR Code



Contact us at
<https://www.tp-link.com/support>
for Technical Support, FAQs & more

Main Device Controls

After you successfully set up your Smart Light Switch, you will see the home page of the Kasa Smart app. Here you can view and manage all devices that you've added to Kasa. Tap your smart switch to control and manage it.

Home Page

Turn on/off your device on the Home page.

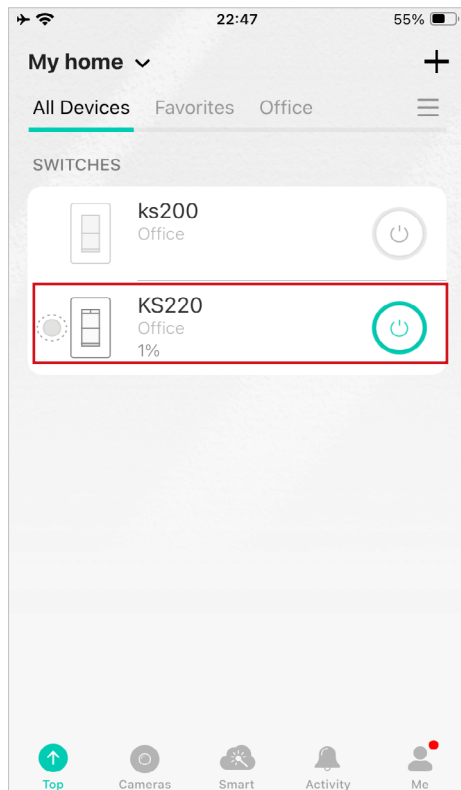

Status Page

Turn on/off your device, change light brightness, or set schedules, timer, Away Mode or check runtime on the Status page.

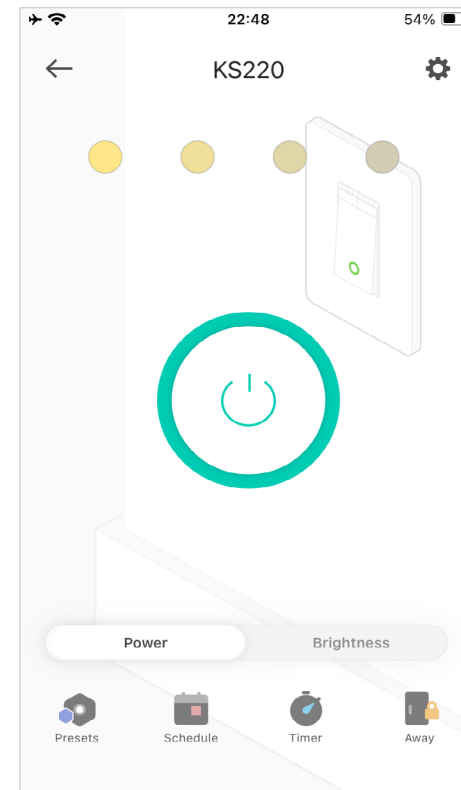

Set Presets

Set preset light brightness to switch to that brightness quickly with just a tap.

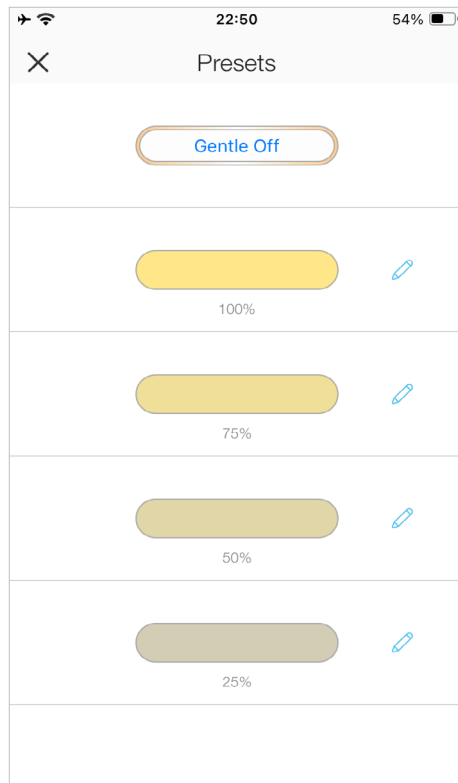

Set Schedules

Set schedules to automatically turn on/off the light at set times according to your daily routine.

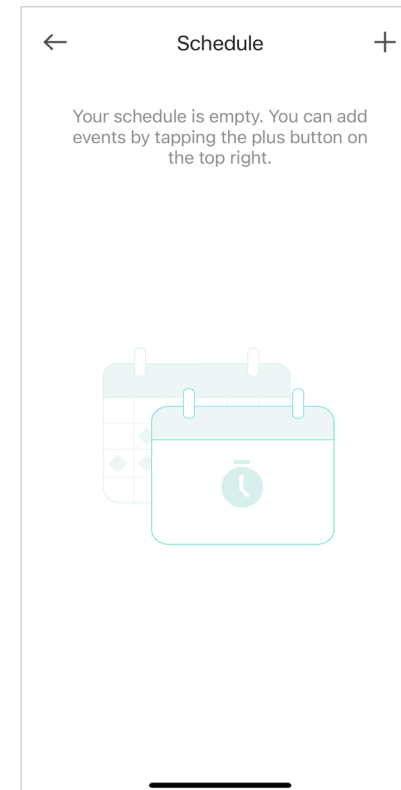

Set a Timer

Set the timer for your dimmer switch to automatically turn on/off after the time ends.

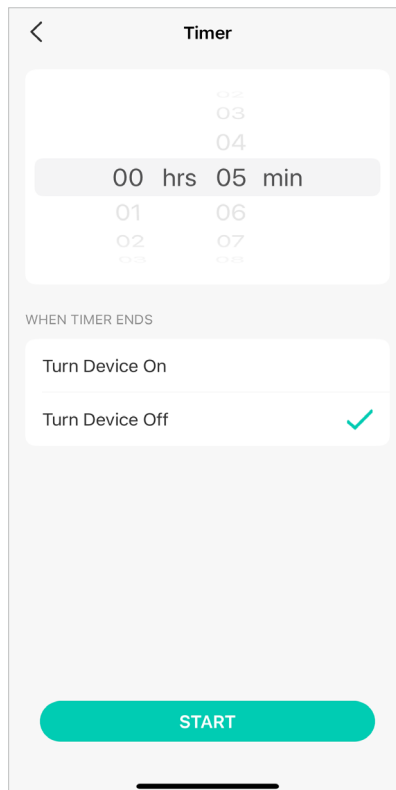

Set Away Mode

Set Away Mode for your dimmer switch to turn on/off the light automatically at random intervals while you are away to make the appearance that someone is at home.

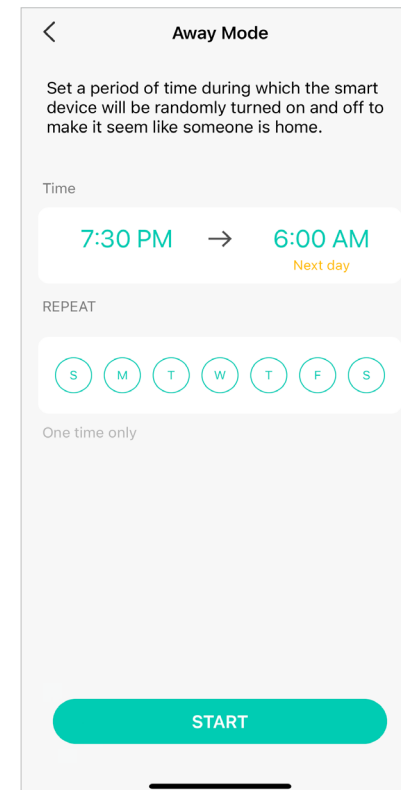

Manage Device Settings

1. Tap  on the Status Page to enter the [Device Settings](#) page.

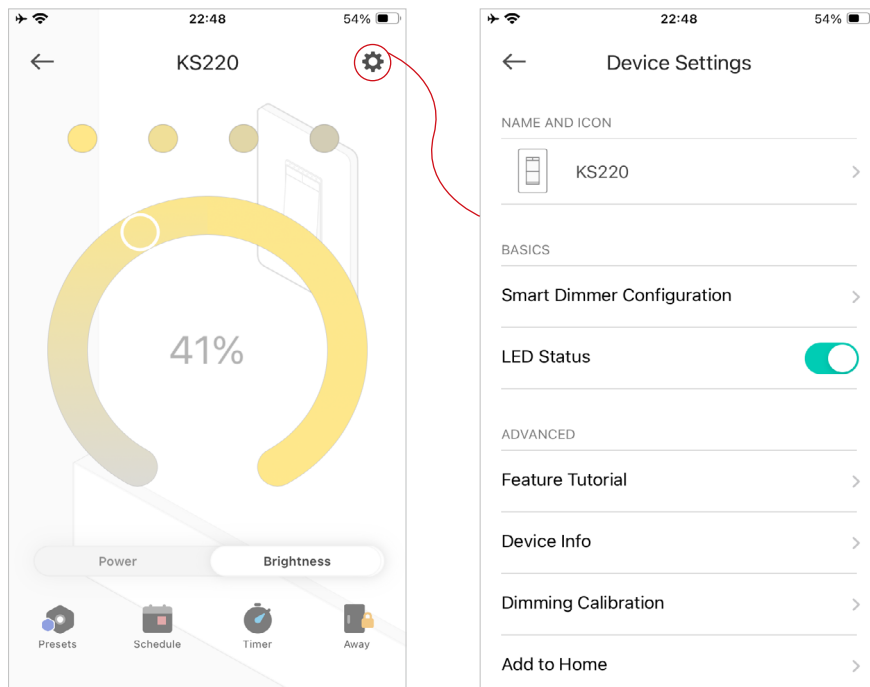

1. Smart Dimmer Configuration

Set fade on/off speed and double tap and long press effects.

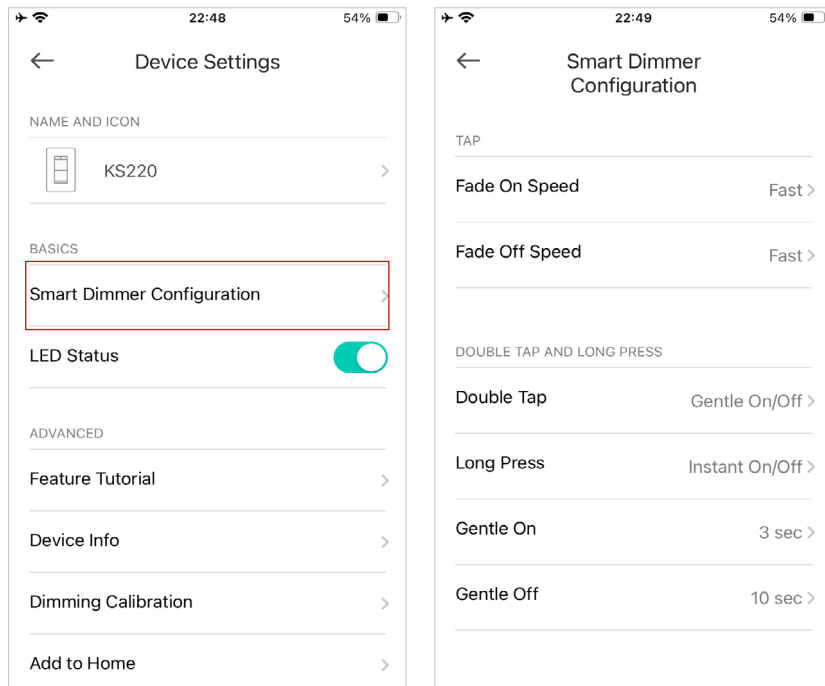

2. Dimming Calibration

Calibrate your dimmer switch to smoothly dim your lights.

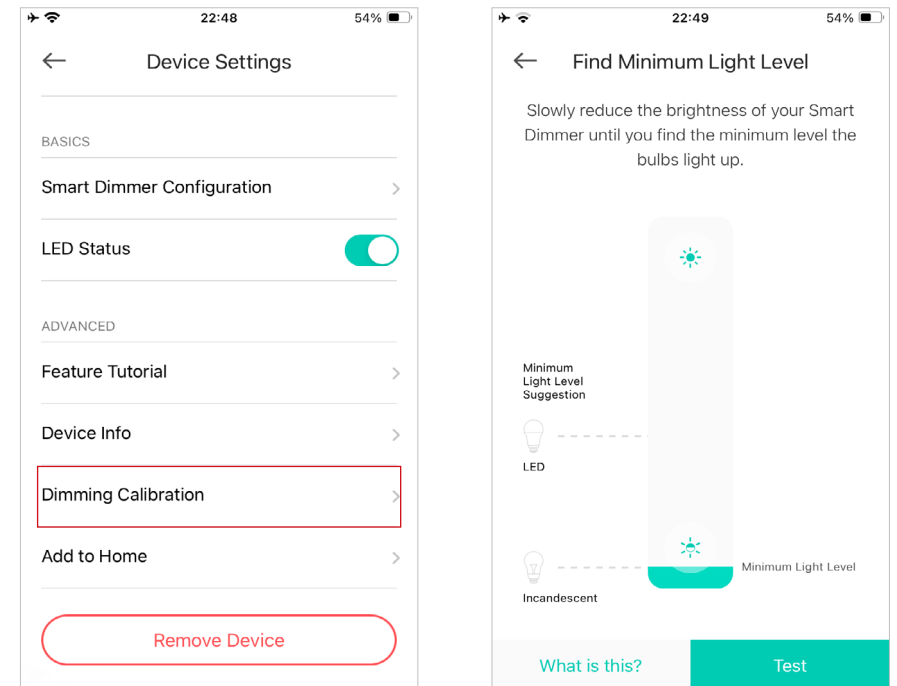

3. Add to Home

Add your device to the Apple Home app for easy control from your iPhone, iPad, or Mac.

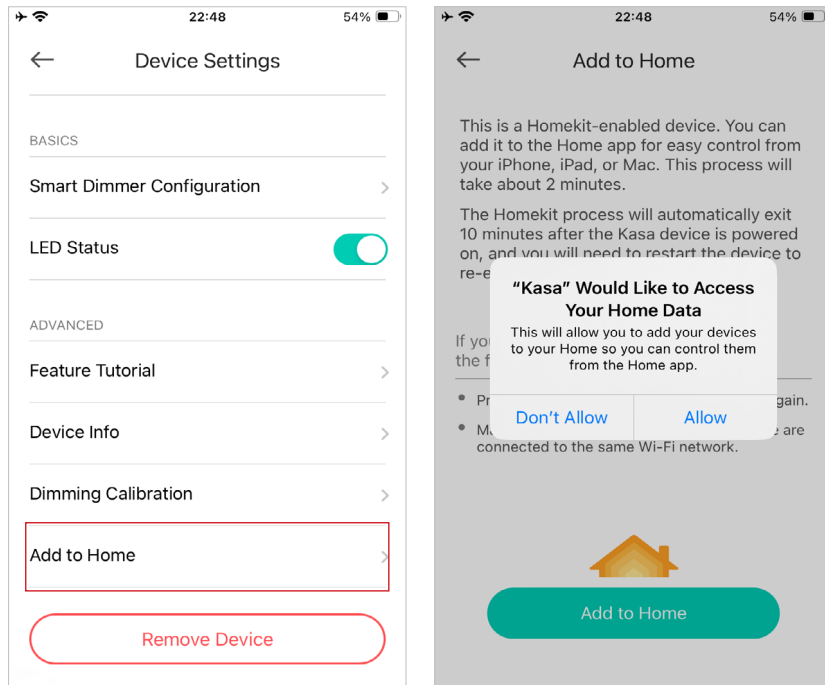

Reset Your Smart Switch

You can remove your device from the Kasa Smart app on the Home page or on the Device Settings page, or by pressing the Reset button on your Smart Switch.

Home Page

Long press your device and then tap  .

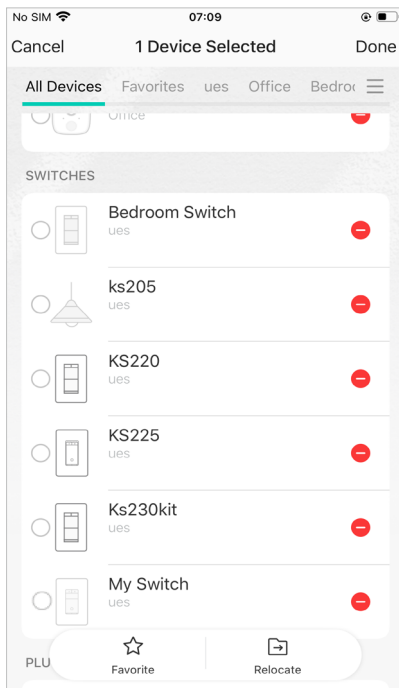

Device Status Page

Tap [Remove Device](#).

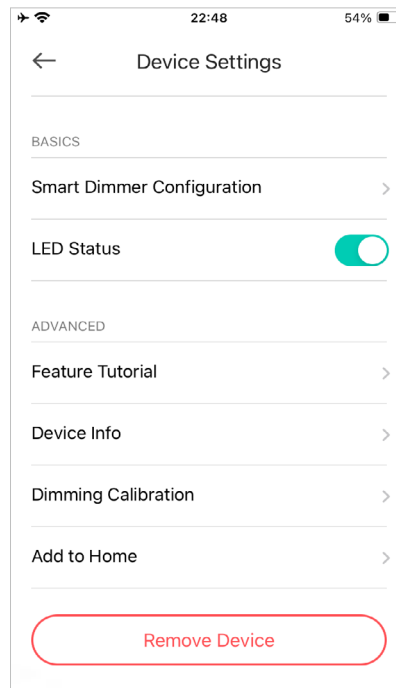

Press the Reset button

Press and hold the [Reset](#) for at least 10 seconds to restore factory default settings.

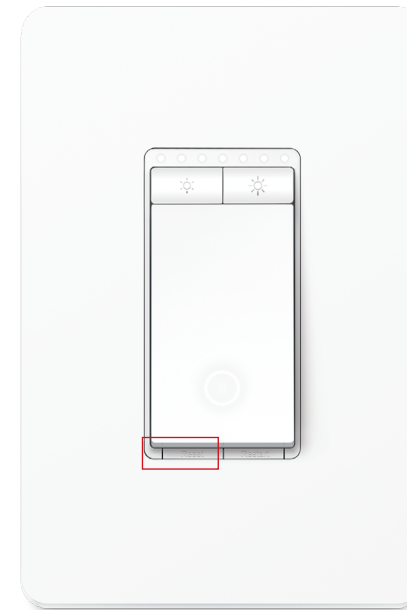

Authentication

FCC compliance information statement



Product Name: Smart Wi-Fi Light Switch, Dimmer

Model Number: KS220

Responsible party:

TP-Link USA Corporation

Address: 10 Mauchly, Irvine, CA 92618

Website: <https://www.tp-link.com/us/>

Tel: +1 626 333 0234

Fax: +1 909 527 6804

E-mail: sales.usa@tp-link.com

This equipment has been tested and found to comply with the limits for a Class B digital device, pursuant to part 15 of the FCC Rules. These limits are designed to provide reasonable protection against harmful interference in a residential installation. This equipment generates, uses and can radiate radio frequency energy and, if not installed and used in accordance with the instructions, may cause harmful interference to radio communications. However, there is no guarantee that interference will not occur in a particular installation. If this equipment does cause harmful interference to radio or television reception, which can be determined by turning the equipment off and on, the user is encouraged to try to correct the interference by one or more of the following measures:

- Reorient or relocate the receiving antenna.
- Increase the separation between the equipment and receiver.
- Connect the equipment into an outlet on a circuit different from that to which the receiver is connected.
- Consult the dealer or an experienced radio/ TV technician for help.

This device complies with part 15 of the FCC Rules. Operation is subject to the following two conditions:

1. This device may not cause harmful interference.

2. This device must accept any interference received, including interference that may cause undesired operation.

Any changes or modifications not expressly approved by the party responsible for compliance could void the user's authority to operate the equipment.

Note: The manufacturer is not responsible for any radio or TV interference caused by unauthorized modifications to this equipment. Such modifications could void the user's authority to operate the equipment.

FCC RF Radiation Exposure Statement

This equipment complies with FCC RF radiation exposure limits set forth for an uncontrolled environment. This device and its antenna must not be co-located or operating in conjunction with any other antenna or transmitter.

"To comply with FCC RF exposure compliance requirements, this grant is applicable to only Mobile Configurations. The antennas used for this transmitter must be installed to provide a separation distance of at least 20 cm from all persons and must not be co-located or operating in conjunction with any other antenna or transmitter."

We, **TP-Link USA Corporation**, has determined that the equipment shown as above has been shown to comply with the applicable technical standards, FCC part 15. There is no unauthorized change is made in the equipment and the equipment is properly maintained and operated.

Issue Date: 2024.04.20

Canadian Compliance Statement

This device contains licence-exempt transmitter(s)/receiver(s) that comply with Innovation, Science and Economic Development Canada's licence-exempt RSS(s). Operation is subject to the following two conditions:

(1) This device may not cause interference.

(2) This device must accept any interference, including interference that may cause undesired operation of the device.

L'émetteur/récepteur exempt de licence contenu dans le présent appareil est conforme aux CNR d'Innovation, Sciences et Développement économique Canada applicables aux appareils radio exempts de licence. L'exploitation est autorisée aux deux conditions suivantes :

1) L'appareil ne doit pas produire de brouillage;

2) L'appareil doit accepter tout brouillage radioélectrique subi, même si le brouillage est susceptible d'en compromettre le fonctionnement.

Radiation Exposure Statement:

This equipment complies with IC radiation exposure limits set forth for an uncontrolled environment. This equipment should be installed and operated with minimum distance 20cm between the radiator & your body.

Déclaration d'exposition aux radiations:

Cet équipement est conforme aux limites d'exposition aux rayonnements IC établies pour un environnement non contrôlé. Cet équipement doit être installé et utilisé avec un minimum de 20 cm de distance entre la source de rayonnement et votre corps

Industry Canada Statement

CAN ICES-3 (B)/NMB-3(B)

NCC Notice

注意!

依據 低功率電波輻射性電機管理辦法

LP0002 低功率射頻器材技術規範 _ 章節 3.8.2

取得審驗證明之低功率射頻器材，非經核准，公司、商號或使用者均不得擅自變更頻率、加大功率或變更原設計之特性及功能。

低功率射頻器材之使用不得影響飛航安全及干擾合法通信；經發現有干擾現象時，應立即停用，並改善至無干擾時方得繼續使用。

前述合法通信，指依電信管理法規定作業之無線電通信。

低功率射頻器材須忍受合法通信或工業、科學及醫療用電波輻射性電機設備之干擾。

BSMI Notice

安全諮詢及注意事項

- 請使用原裝電源供應器或只能按照本產品注明的電源類型使用本產品。
- 清潔本產品之前請先拔掉電源線。請勿使用液體、噴霧清潔劑或濕布進行清潔。
- 注意防潮，請勿將水或其他液體潑灑到本產品上。
- 插槽與開口供通風使用，以確保本產品的操作可靠並防止過熱，請勿堵塞或覆蓋開口。
- 請勿將本產品置放於靠近熱源的地方。除非有正常的通風，否則不可放在密閉位置中。
- 不要私自拆開機殼或自行維修，如產品有故障請與原廠或代理商聯繫。

限用物質含有情況標示聲明書

設備名稱： Equipment name Smart Wi-Fi Light Switch, Dimmer		型號（型式）： Type designation (Type) KS220				
單元 Unit	限用物質及其化學符號 Restricted substances and its chemical symbols					
	鉛 Lead (Pb)	汞 Mercury (Hg)	鎘 Cadmium (Cd)	六價鉻 Hexavalent chromium (Cr+6)	多溴聯苯 Polybrominated biphenyls (PBB)	多溴二苯醚 Polybrominated diphenyl ethers (PBDE)
PCB	○	○	○	○	○	○
外殼	○	○	○	○	○	○
電源供應板	—	○	○	○	○	○
其他及其配件	—	○	○	○	○	○

備考 1. “超出 0.1 wt %” 及 “超出 0.01 wt %” 係指限用物質之百分比含量超出百分比含量基準值
Note 1: “Exceeding 0.1 wt %” and “exceeding 0.01 wt %” indicate that the percentage content of the restricted substance exceeds the reference percentage value of presence condition.
備考 2. “○” 係指該項限用物質之百分比含量未超出百分比含量基準值。
Note 2: “○” indicates that the percentage content of the restricted substance does not exceed the percentage of reference value of presence.
備考 3. “—” 係指該項限用物質為排除項目。
Note 3: The “—” indicates that the restricted substance corresponds to the exemption.

Safety Information

- Keep the device away from water, fire, humidity or hot environments.
- Do not attempt to disassemble, repair, or modify the device.
- Do not use the device where wireless devices are not allowed.
- Operating temperature: 0°C ~40°C (32 °F ~104 °F); Storage Temperature: -40°C ~60°C (-40 °F ~140 °F)

Follow all national and local safety regulations and practices. If you are uncertain or uncomfortable when performing the installation, consult a qualified electrician.

- Install only in a suitable UL or equivalent Listed outlet box.
- CAUTION – Risk of electric Shock – More than one disconnect switch may be required to de-energize the equipment before servicing. A circuit breaker which disconnects the Live and Neutral conductor simultaneously is suitable. Ensure power is off at the circuit breaker before removing or installing any wall switch.
- Do not install the Smart Switch with wet hands or when standing on wet or damp surfaces.
- The Smart Switch must be installed and used in accordance with the National Electric Code (NEC) or your local electrical code. If you are unfamiliar with these codes and requirements, or are uncomfortable performing the installation, consult a qualified electrician.
- Tighten terminal screws to 13 lbf-in.



CAUTION

Electronic switch integrated in this product is only intended for functional purposes. De-energized the product at the circuit breaker before servicing.

CAUTION:











To Reduce the Risk of Electric Shock – Use Only Indoors.







USE ONLY IN DRY LOCATIONS.

Please read and follow the above safety information when operating the device. We cannot guarantee that no accidents or damage will occur due to improper use of the device. Please use this product with care and operate at your own risk.

Explanation of the symbols on the product label

Symbol	Explanation
	Class II equipment
	Class II equipment with functional earthing
	Alternating current
	DC voltage
	Polarity of output terminals
	Indoor use only

Symbol	Explanation
	Dangerous voltage
	Caution, risk of electric shock
	Energy efficiency Marking
	Protective earth
	Earth
	Frame or chassis
	Functional earthing
	Caution, hot surface
	Caution
	Operator's manual
	Stand-by

Symbol	Explanation
	"ON"/"OFF" (push-push)
	Fuse
	Fuse is used in neutral N
	<p>RECYCLING</p> <p>This product bears the selective sorting symbol for Waste electrical and electronic equipment (WEEE). This means that this product must be handled pursuant to European directive 2012/19/EU in order to be recycled or dismantled to minimize its impact on the environment.</p> <p>User has the choice to give his product to a competent recycling organization or to the retailer when he buys a new electrical or electronic equipment.</p>
	Caution, avoid listening at high volume levels for long periods
	Disconnection, all power plugs
m	Switch of mini-gap construction
μ	<p>Switch of micro-gap construction (for US version)</p> <p>Switch of micro-gap / micro-disconnection construction (for other versions except US)</p>
ε	Switch without contact gap (Semiconductor switching device)