























## Operating and installation instructions Fridge-freezer



It is **essential** to read the operating and installation instructions before setup, installation, and commissioning. This prevents both personal injury and damage to the appliance.

# Contents

<b>Warning and Safety instructions ..</b>	<b>4</b>	Safety .....	30
<b>Sustainability and environmental protection .....</b>	<b>13</b>	Temperature alarm in the freezer zone .....	30
How to save energy .....	14	Door alarm .....	31
<b>Installation .....</b>	<b>15</b>	Appliance functions .....	32
Installation site .....	15	SuperCool & AirClean  .....	32
Ventilation requirements .....	16	SuperFreeze  .....	32
Installing the refrigeration appliance .....	17	Adjusting the interior fittings .....	33
Aligning the refrigeration appliance .....	18	Maximum load weights .....	33
Aligning the fridge zone door .....	18	Removing and moving the door shelves/bottle shelf .....	33
Aligning the freezer zone door .....	19	Adjusting the holders in the door shelf/bottle shelf .....	33
Electrical connection .....	20	Removing or moving the shelves .....	34
Appliance dimensions .....	21	Removing the drawers from the fridge zone .....	34
Completely surrounded by kitchen furniture .....	23	Inserting the drawers in the fridge zone .....	35
Installation next to a wall .....	24	Removing the freezer drawer/ Freeze&Cool drawer .....	35
<b>Familiarisation .....</b>	<b>25</b>	Inserting the freezer drawer/ Freeze&Cool drawer .....	35
Display .....	27	Removing a glass plate .....	35
Settings mode  .....	28	Inserting a glass plate .....	36
Party mode  .....	28	Accessories supplied .....	36
Holiday mode  .....	28	Optional accessories .....	36
Lock function  /  .....	28	<b>Commissioning .....</b>	<b>37</b>
Switching the refrigeration appliance off  .....	28	Before using for the first time .....	37
Sabbath mode  .....	29	Connecting the refrigeration appliance .....	37
Information on Sabbath mode  .....	29	Inserting charcoal filters (AirClean System) into the fridge zone .....	37
Time before door alarm  is triggered .....	29	Switching the refrigeration appliance on .....	39
Networking  .....	29	Networking .....	39
Keypad tone  /  .....	29	Requirements for networking .....	39
Alarms and buzzers  /  .....	29	Performing Scan & Connect .....	40
Display brightness  .....	29	Switching the refrigeration appliance off .....	40
Temperature unit °C/°F .....	29	Switching off the fridge zone, freezer zone or Freeze&Cool zone separately .....	40
Demo mode  .....	29		
Factory defaults  .....	29		
Information on the refrigeration appliance  .....	29		
Charcoal filter (AirClean System) indicator  .....	30		
Cleaning mode  .....	30		

Switching the fridge zone, freezer zone or Freeze&Cool zone back on again separately ...	41	Removing and dismantling accessories for cleaning .....	57
Switching off for longer periods of time .....	41	Dismantling the bottle shelf.....	57
<b>Operation</b> .....	<b>42</b>	Removing the compartment cover for cleaning and reinserting it.....	58
Temperature display .....	42	Cleaning the front of the appliance and the side panels.....	59
Temperature range in the fridge zone .....	42	Cleaning the door seal.....	59
Temperature range in the freezer zone .....	42	Cleaning the ventilation openings ...	59
Temperature range in the Freeze&Cool zone .....	43	After cleaning.....	59
Setting temperatures in the various zones .....	43	<b>Troubleshooting</b> .....	<b>61</b>
Switching on SuperCool & AirClean ❄️🌀 .....	43	Interior lighting .....	70
Switching off SuperCool & AirClean ❄️🌀 .....	43	Noises .....	70
Switching SuperFreeze ❄️ on .....	44	<b>Service</b> .....	<b>73</b>
Switching SuperFreeze ❄️ off .....	44	Contact in the event of a fault.....	73
Storing food in the fridge zone .....	44	EPREL database.....	73
Different storage zones.....	44	Warranty .....	73
Should food be stored loose or in packaging?.....	45	<b>Information</b> .....	<b>74</b>
Storing food in the DailyFresh drawer .....	45	EU Conformity declaration .....	74
Storing food in the Freeze&Cool zone .....	46	UK Conformity declaration .....	74
Choosing the right setting.....	46	Copyrights and licences.....	75
Storage recommendation for the Freeze&Cool zone.....	46		
Freezing and storing fresh food .....	47		
<b>Adjusting settings</b> .....	<b>49</b>		
<b>Cleaning and care</b> .....	<b>56</b>		
Defrosting.....	56		
Cleaning agents .....	56		
Preparing the refrigeration appliance for cleaning.....	56		
Cleaning the interior of the appliance .....	56		
Cleaning accessories by hand or in the dishwasher .....	57		

## Warning and Safety instructions

---

This refrigeration appliance complies with current safety requirements. Inappropriate use can, however, lead to personal injury and material damage.

Please read the operating and installation instructions carefully before using the refrigeration appliance for the first time. They contain important information on installation, safety, use and maintenance. This is to protect yourself from injury, and from damaging your refrigeration appliance.

In accordance with standard IEC 60335-1, Miele expressly and strongly advises that you read and follow all information provided on installing the refrigeration appliance, as well as the warning and safety notes.

Miele cannot be held liable for injury or damage caused by non-compliance with these instructions.

Keep these operating and installation instructions in a safe place and pass them on to any future owner.

### Correct application

► This refrigeration appliance is intended for use in the home and in similar environments; for example:

- In shops, offices and similar work settings
- On agricultural estates
- By the guests in hotels, motels, bed and breakfasts, and other typical home settings.

This refrigeration appliance is not intended for outdoor use.

► This appliance is intended for domestic use only for cooling and storing food and drink as well as for storing deep frozen food, freezing fresh food and for making ice.

Any other usage is not supported by the manufacturer and could be dangerous.

► This refrigeration appliance is not suitable for storing and keeping cool medicines, blood plasma, laboratory preparations or similar substances or products that are subject to the Medical Device Directive. Incorrect use of the refrigeration appliance for such purposes may cause deterioration of the items stored. The refrigeration appliance is also not suitable for use in areas where there is a risk of explosion.

Miele cannot be held liable for damage caused by improper or incorrect use or operation of the appliance.

# Warning and Safety instructions

---

▶ The appliance can only be used by people with reduced physical, sensory or mental capabilities, or lack of experience and knowledge, if they are supervised whilst using it, or have been shown how to use it in a safe way and recognise and understand the consequences of incorrect operation.

## Safety with children

▶ Children under 8 years of age must be kept away from the refrigeration appliance unless they are constantly supervised.

▶ Children 8 years and older may only use the appliance unsupervised if they have been shown how to use it in a safe way and recognise and understand the consequences of incorrect operation.

▶ Children must not be allowed to clean or maintain the appliance unsupervised.

▶ Please supervise children in the vicinity of the appliance and do not let them play with it.

▶ Danger of suffocation. Whilst playing, children may become entangled in packaging material (such as plastic wrapping) or pull the packaging material over their head, presenting the risk of suffocation. Keep packaging material away from children.

## Technical safety

▶ The coolant circuit has been checked for leaks. The refrigeration appliance complies with statutory safety requirements and the appropriate EU directives.



If the cooling circuit is damaged, refrigerant and oil can escape and ignite.

▶ **Warning: fire hazard/flammable materials.** This symbol is on the compressor and indicates flammable materials. Do not remove this sticker.

## Warning and Safety instructions

---

The refrigerant inside the appliance (details on the data plate) is environmentally friendly but flammable.

The use of this refrigerant does, however, sometimes lead to a slight increase in the noise level of the appliance. In addition to the noise of the compressor, you might be able to hear the refrigerant flowing around the cooling circuit. Unfortunately, this cannot be avoided, but it does not affect the performance of the refrigeration appliance.

When transporting and installing the refrigeration appliance, ensure that no parts of the cooling circuit are damaged. Splashes of refrigerant can damage the eyes and leaking refrigerant can ignite.

In the event of damage:

- Avoid naked flames or anything which creates a spark.
- Disconnect the refrigeration appliance from the mains electricity supply.
- Ventilate the room where the refrigeration appliance is located for several minutes.
- Contact the Miele Customer Service Department.

▶ The more refrigerant there is in a refrigeration appliance, the larger the room it should be installed in. In the event of a leakage, if the appliance is in a small room, there is the danger of a combustible gas/air mixture building up. For every 8 g of refrigerant at least 1 m<sup>3</sup> of room space is required. The amount of refrigerant in the refrigeration appliance is stated on the data plate inside the appliance.

▶ If the ventilation cross-sections are covered or blocked, a combustible gas/air mixture can form if the cooling circuit is damaged. It is essential to observe the required ventilation cross-sections. The ventilation cross-sections must not be covered or blocked in any way.

▶ To avoid the risk of damage to the appliance, make sure that the connection data (fuse rating, frequency and voltage) on the data plate corresponds to the household supply.

Check that this is the case before connecting the appliance. Consult a qualified electrician if in any doubt.

▶ The electrical safety of this appliance can only be guaranteed when correctly earthed. It is essential that this standard safety requirement is met. If in any doubt please have the electrical installation tested by a qualified electrician.

## Warning and Safety instructions

---

▶ Temporary or permanent operation on an autonomous power supply system or a power supply system that is not synchronised with the mains power supply (e.g. island networks, back-up systems) is possible. A prerequisite for operation is that the power supply system complies with the specifications of EN 50160 or an equivalent standard.

The function and operation of the protective measures provided in the domestic electrical installation and in this Miele product must also be maintained in isolated operation or in operation that is not synchronised with the mains power supply, or these measures must be replaced by equivalent measures in the installation. As described, for example, in the current version of BS OHSAS 18001–2 ISO 45001.

▶ The socket must not be concealed behind the refrigeration appliance and must be easily accessible so that the appliance can be quickly disconnected from the electrical supply in case of an emergency.

▶ If the mains connection cable is damaged, disconnect the refrigeration appliance from the power supply immediately. Contact the Miele Customer Service Department.

▶ If the mains connection cable is damaged, it must only be replaced with a specific mains connection cable of the same type (available from the Miele online shop or Miele Customer Service). For safety reasons, such replacement may only be carried out by a qualified specialist or Miele Customer Service.

▶ Do not connect the appliance to the mains electrical supply by a multi-socket adapter or extension lead. These are a fire hazard and do not guarantee the required safety of the appliance.

▶ If moisture gets into electrical components or into the mains connection cable, it could cause a short circuit. Therefore, do not operate this refrigeration appliance in areas which are exposed to moisture (e.g. in a garage or utility room).

▶ This appliance must not be used in a non-stationary location (e.g. on a ship).

▶ Do not use a damaged appliance. It could be dangerous. Check the appliance for visible signs of damage.

▶ For safety reasons, this appliance may only be used after it has been built in.

## Warning and Safety instructions

---

▶ The appliance must be isolated from the electricity supply during installation, maintenance and repair work. It is only completely isolated from the power supply when:

- the mains fuses are switched off, or
- the screw-out fuse is removed (where applicable), or
- the mains cable has been unplugged. Pull on the plug and not the cable when disconnecting it from the power supply.

▶ Unauthorised installation, maintenance or repairs could result in unforeseen dangers for the user, for which the manufacturer cannot accept liability.

Installation, maintenance or repairs must only be carried out by a qualified specialist or Miele Customer Service.

▶ The manufacturer's warranty will be invalidated if the refrigeration appliance is not repaired by a qualified specialist or Miele Customer Service.

▶ We recommend replacing defective components with original spare parts. If original Miele spare parts are installed correctly, Miele ensures full compliance with safety requirements and the warranty remains valid.

▶ This refrigeration appliance is fitted with a special lamp to cope with particular conditions (e.g. temperature, moisture, chemical resistance, abrasion resistance and vibration). This lamp must only be used for the purpose for which it is intended. The lamp is not suitable for room lighting. Replacement lamps may only be fitted by a qualified specialist or by Miele Customer Service. This refrigeration appliance contains several light sources with at least energy efficiency class G.

▶ In areas which may be subject to infestation by cockroaches or other vermin, pay particular attention to keeping the appliance and its surroundings clean at all times. Any damage caused by cockroaches or other vermin will not be covered by the warranty.

### Proper installation

▶ The refrigeration appliance is heavy and can tip forwards when the appliance doors and drawers are open:

- At least 2 people are required to transport or move the refrigeration appliance.
- At least 2 people are required to install the refrigeration appliance.

## Warning and Safety instructions

---

- Never leave the refrigeration appliance unattended while it is being installed.
  - Align the refrigeration appliance using the adjustable feet so it stands firm and level. Ensure that the additional adjustable foot on the hinge plate at the bottom is resting on the floor.
- ▶ Always wear protective gloves when transporting and installing the refrigeration appliance.

### Correct use

- ▶ This refrigeration appliance is designed for use within specific ambient temperatures (climate range). Do not use in ambient temperatures for which it is not designed. The climate range is stated on the data plate in the interior cabinet of the refrigeration appliance. A lower ambient temperature will cause the compressor to switch off for longer periods, meaning that the refrigeration appliance is unable to maintain the required temperature.
- ▶ The ventilation cross-sections must not be covered or blocked in any way. This can impair the proper ventilation of the appliance, increase the energy consumption and cause damage to the components.
- ▶ Risk of damage due to greasy or oily foods. If the refrigeration appliance or the appliance door is used for storing food which contains fat or oil, make sure that it does not come into contact with plastic components. Any spillages of oil or fat could cause stress cracks to the plastic and cause it to break or split.
- ▶ Risk of fire and explosion due to flammable mixes of gases. Do not store explosive materials in the refrigeration appliance or any products containing propellants (e.g. spray cans). Electrical components can cause flammable mixes of gases to ignite. The spray cans in question can be identified by the contents printed on the can or by a flame symbol. Electrical components can cause escaping gases to ignite.
- ▶ Danger of explosion. Do not operate any electrical equipment (e.g. an electric ice-cream maker) inside the refrigeration appliance. This can cause sparking and explosion.
- ▶ Danger of injury and damage to the appliance. Do not store cans or bottles containing carbonated drinks or liquids which could freeze in the freezer zone. Otherwise they could burst.

## Warning and Safety instructions

---

- ▶ Danger of injury and damage to the appliance. When cooling drinks quickly in the freezer zone, make sure bottles are not left in for more than one hour. Otherwise they could burst.
- ▶ Danger of injury. Never handle frozen food or the metal parts of the appliance with wet hands. Your hands may freeze to the frozen food or to the metal.
- ▶ Danger of injury. Do not take ice cubes out with your bare hands and never place ice cubes or ice lollies in your mouth straight from the freezer zone. The very low temperature of the frozen food can cause frost burn to the lips and tongue.
- ▶ Do not refreeze partially or fully defrosted food. Consume defrosted food as soon as possible, as it will lose its nutritional value and spoil if left for too long. Defrosted food may only be re-frozen after it has been cooked.
- ▶ Observe the manufacturer's "use-by" dates and storage instructions given on food to avoid the risk of food poisoning. Storage times will depend on several factors, including the freshness and quality of the food, as well as the temperature at which it is stored.
- ▶ To ensure that fresh food placed in the freezer freezes through to the core as quickly as possible, the maximum freezing capacity must not be exceeded. The maximum freezing capacity for freezing within a 24-hour period is given on the data plate: "Freezing capacity ... kg/24 hrs".
- ▶ In areas which may be subject to infestation by cockroaches or other vermin, pay particular attention to keeping the appliance and its surroundings clean at all times. Any damage caused by cockroaches or other vermin will not be covered by the warranty.

### Stainless steel appliances

- ▶ Adhesives will damage the stainless steel surface and cause it to lose its dirt-repellent protective coating. Do not use sticky notes, transparent adhesive tape, masking tape or other types of adhesive on the stainless steel surface.
- ▶ The surface is susceptible to scratching. Even magnets can cause scratching.

## Accessories and spare parts

- ▶ We recommend using original Miele accessories. If other parts are used, warranty, performance and/or product liability claims will be invalidated.
- ▶ Miele original spare parts are kept in stock for at least 10 years and up to 15 years after discontinuation of your refrigeration appliance.

## Cleaning and care

- ▶ Do not use any oils or grease on the door seals, as these will cause the seals to deteriorate and become porous with time.
- ▶ Warning. Do not use any mechanical tools or other types of aid which are not recommended by the manufacturer to accelerate the defrosting process.
- ▶ Do not use a steam cleaning appliance to clean or defrost this appliance. Steam could reach electrical components and cause a short circuit.
- ▶ Sharp edged or pointed objects will damage the evaporator, causing irreversible damage to the appliance. Do not use sharp edged or pointed objects to
  - remove frost and ice,
  - separate frozen food or remove ice trays.
- ▶ Do not place electric heaters or candles in the appliance to defrost it. These can damage the plastic parts.
- ▶ Do not use defrosting sprays or de-icers. Defrosting sprays and de-icers can contain substances which could damage the plastic parts or which might cause a build-up of explosive gases and pose a danger to health.

## Transport

- ▶ To avoid damage to the refrigeration appliance, always transport it upright and in its packaging.
- ▶ Danger of injury and damage to the appliance. The refrigeration appliance is very heavy and must be transported by two people.

## Disposal of your old appliance

- ▶ Children playing could become trapped in the refrigeration appliance and could suffocate.

## Warning and Safety instructions

---

- Remove the appliance door(s).
- Remove the drawers.
- Leave the shelves in the refrigeration appliance so that children cannot climb inside.
- If your old refrigeration appliance has a door lock, destroy it. This will prevent the risk of children playing accidentally locking themselves in the appliance and endangering their lives.

▶ Risk of electric shock!

- Cut the plug off the mains connection cable.
- Cut the mains connection cable off the old appliance.

Dispose of the plug and mains connection cable separately from the old appliance.

▶ During and after disposal, make sure that the refrigeration appliance is not placed near petrol or other flammable gases and liquids.

▶ Risk of fire due to escaping oil or refrigerant.

The refrigerant and oil inside the appliance are flammable. In high enough concentrations, escaping refrigerant or oil can ignite if they come into contact with an external heat source.

During disposal, make sure that the cooling circuit is not damaged. This prevents refrigerant and oil escaping in an uncontrolled manner (see the data plate for details of the refrigerant).

▶ Splashes of coolant can damage the eyes. Be careful not to damage any part of the pipework whilst awaiting disposal, e.g. by

- puncturing the coolant channels in the condenser,
- bending any pipework, or
- scratching the surface coating.

### Symbol on the compressor (depending on model)

This information is only relevant for recycling. There is no risk during normal operation.



▶ The oil in the compressor can be fatal if swallowed or if it penetrates the airways.

## Disposing of the packaging material

The packaging material is used for handling and protects the appliance from transport damage. The packaging material used is selected from materials which are environmentally friendly for disposal and can generally be recycled.

Recycling the packaging material reduces the use of raw materials. Use material-specific collection points for valuable materials and take advantage of return options. Your Miele dealer will take the packaging material away.

## Disposing of your old appliance

Electrical and electronic appliances contain many valuable materials. They also contain certain materials, compounds and components which were essential for their correct functioning and safety. These could be hazardous to human health and to the environment if disposed of with household waste or if handled incorrectly. Please do not, therefore, dispose of your old appliance with household waste.



Take care not to damage your refrigeration appliance before or during disposal in an authorised, environmentally friendly manner.

This is to ensure that refrigerant in the cooling circuit and oil in the compressor is contained, and will not leak into the environment.

Instead, please make use of officially designated collection and disposal points to dispose of and recycle electrical and electronic appliances in your local community, with your dealer or with Miele, free of charge. By law, you

are solely responsible for deleting any personal data from the old appliance prior to disposal. You are legally obliged to remove any old batteries which are not securely enclosed by the appliance and to remove any lamps without destroying them, where this is possible. These must be taken to a suitable collection point where they can be handed in free of charge. Please ensure that your old appliance poses no risk to children while being stored for disposal.

# Sustainability and environmental protection

---

## How to save energy ...

---

- Installation site** The refrigeration appliance has to cool more often at higher ambient temperatures and consumes more energy in the process. Therefore:
- Install the refrigeration appliance in a well-ventilated room.
  - Do not install the refrigeration appliance near to a heat source (heater element, cooker).
  - Protect the refrigeration appliance from direct sunlight.
  - Ensure an ideal ambient temperature of 20 °C.
  - Clean the ventilation openings on a regular basis to remove any dust.
- Temperature setting** The colder the temperature, the higher the energy consumption. The following settings are recommended:
- 4 °C in the fridge zone
  - -18 °C in the freezer zone
- Use** Energy consumption is increased by heat input and impeded air circulation. Therefore:
- Only open the appliance door/appliance doors when necessary and for as short a time as possible. Arrange the food in such a way that makes it easy to find in the appliance.
  - Always close the appliance door/appliance doors properly after opening.
  - Allow hot food and drinks to cool down before placing them in the refrigeration appliance.
  - Store food well packaged or covered.
  - Do not overfill the compartments to allow air to circulate.
  - Place frozen food in the fridge zone to defrost.
  - Keep drawers and shelves arranged as they were when the appliance was delivered.
  - Maintain a distance of 30 mm between the back of the appliance and the wall.

## Installation site

 Risk of fire and damage from appliances which give off heat.

Appliances which give off heat can catch fire and set fire to the refrigeration appliance.

The mains connection cable must not come into contact with heat sources.

Do not place appliances which give off heat, such as mini-ovens, double burner hobs or toasters on the refrigeration appliance.

 Fire risk and danger of damage from open flames.

Open flames can set fire to the refrigeration appliance.

Keep open flames (e.g. a candle) away from the refrigeration appliance.

 Risk of fire and damage due to improper installation.

If the mains plug and mains connection cables touch the back of the refrigeration appliance, they may be damaged by vibrations and cause a short circuit.

Mains plugs or mains connection cables must not touch the refrigeration appliance.

Mains connection cables must not be trapped or damaged.

Do not connect any other appliances to sockets located directly behind this refrigeration appliance.

Do not place or operate multi-socket adapters, distributor strips or other electronic devices (such as halogen transformers) behind the appliance.

This appliance should be installed in a dry, well-ventilated room.

The floor at the installation site must be horizontal and level and must be as high as the surrounding floor.

 Risk of damage due to high humidity.

In environments with high humidity, condensation can build up on external refrigeration appliance panels.

This condensation can cause corrosion on external appliance panels.

Install the refrigeration appliance in a dry and/or air-conditioned room with sufficient ventilation.

After installation, please make sure that the appliance door/appliance doors closes/close properly and the refrigeration appliance is installed in accordance with these installation instructions. It is essential to comply with the specified ventilation cross-sections.

When deciding on the installation site, please bear in mind that your refrigeration appliance will consume more energy if installed near to a heater, a cooker or another appliance that gives off heat. Avoid direct sunlight. Higher ambient temperatures increase energy consumption as the compressor runs for longer.

# Installation

## Climate range

This refrigeration appliance is designed for use within specific ambient temperatures (climate range). Do not use in ambient temperatures for which it is not designed. The climate range applicable to your refrigeration appliance can be found on the data plate inside the appliance.

The compressor runs less frequently at low ambient temperatures. This can cause the internal temperature in the refrigeration appliance to rise with the risk of food deteriorating and going off.

Climate range	Ambient temperature
SN	10 to 32 °C
N	16 to 32 °C
ST	16 to 38 °C
T	16 to 43 °C
SN-ST	10 to 38 °C
SN-T	10 to 43 °C

## Ventilation requirements



Fire risk and risk of damage due to inadequate ventilation.

If the refrigeration appliance is not ventilated sufficiently, the compressor will run more frequently and for longer periods. This causes increased energy consumption and an increased compressor operating temperature, which can result in damage to the refrigeration appliance.

Please ensure that there is adequate ventilation around the refrigeration appliance:

It is essential to observe the required ventilation cross-sections.

The ventilation cross-sections must not be covered or blocked in any way.

Clean the ventilation areas regularly to remove dust and dirt.

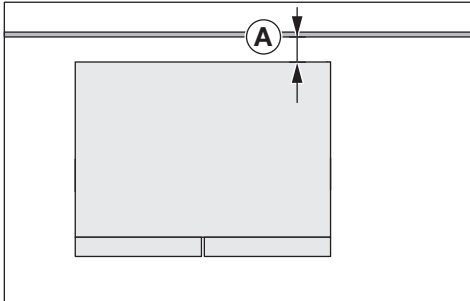

The energy consumption was calculated with a distance  $\textcircled{A}$  = 30 mm between the back of the appliance and the wall. If the distance to the wall is less than 30 mm, the functionality of the refrigeration appliance is maintained, but energy consumption increases slightly.

Air at the back of the refrigeration appliance gets warm. Sufficient space for proper ventilation must therefore be ensured (see “Appliance dimensions”).

## Installing the refrigeration appliance

 Risk of injury and damage due to the refrigeration appliance tipping over.

There is an increased risk of injury and damage if the refrigeration appliance is installed by a single person. Two people are required for installing the refrigeration appliance.

 Risk of damage to the appliance door caused by impact.

The appliance door could hit the wall of the room resulting in damage to the door.

Protect the appliance door by fitting a felt stopper, for example, to the wall of the room.

 Risk of damaging the floor.

Moving the refrigeration appliance can cause damage to the floor.

Move the refrigeration appliance carefully on floors that are sensitive to scratching.

For easier installation, there are transport handles on the back at the top and transport wheels underneath the refrigeration appliance (depending on the model).

The refrigeration appliance must be empty when it is installed.

# Installation

- Connect the refrigeration appliance to the mains power supply as described in “Electrical connection”.
- Move the refrigeration appliance carefully to its intended installation site.
- Position the refrigeration appliance with its back facing the wall, taking the necessary distance into account.

## Aligning the refrigeration appliance

 Risk of damage and injury caused by the appliance doors falling out or the refrigeration appliance tipping over.

If the additional adjustable feet **2** are not resting firmly on the floor, the appliance doors may fall out or the refrigeration appliance may tip over.

Use the open spanner supplied to unscrew the adjustable feet until they are touching the floor.

Then unscrew the adjustable feet by a further quarter turn.

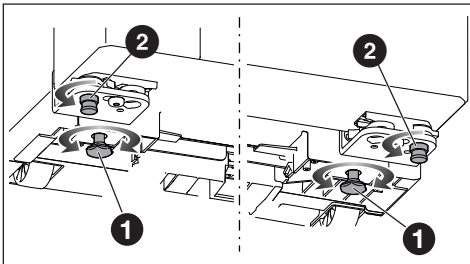

- Align the refrigeration appliance using a spirit level and the open spanner supplied and make sure the refrigeration appliance has additional support in the front area.

- Adjust the adjustable feet **1** so the refrigeration appliance stands firm and level.
- Unscrew the additional adjustable feet **2** until they are touching the floor. Then unscrew the adjustable feet by a further quarter turn.

## Aligning the fridge zone door

The appliance doors/drawers are set correctly at the factory. If the door gap or the distance between the fridge section and freezer section appears uneven, you can readjust the alignment yourself.

Align the fridge zone door on the top hinge bracket as described below:

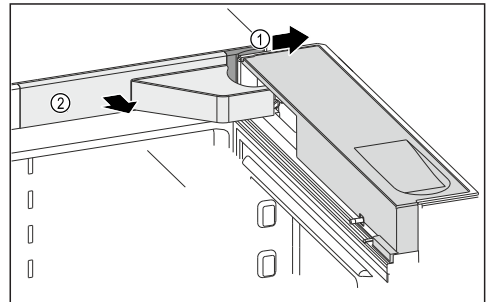

- Open the appliance door.
- Remove covers **1** and **2**.

**⚠ Risk of injury due to appliance door falling out.**

As soon as you completely remove the screws on the door hinge, the appliance door may fall out.

Loosen the screws but do not remove them completely. Hold the appliance door firmly.

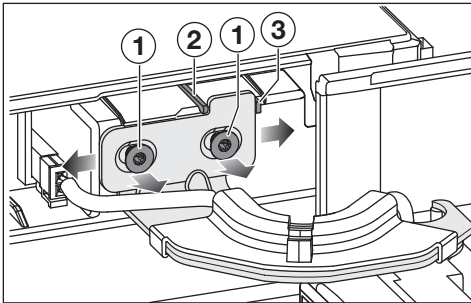

- Loosen the screws ①.

Depending on the direction in which the appliance door is to be moved, the relevant securing element must be removed first.

- Remove securing element ② if you want to move the appliance door to the left.
- Remove securing element ③ if you want to move the appliance door to the right.
- Move the appliance door until the desired position is reached.
- Tighten the screws ①.
- Fit the covers.

## Aligning the freezer zone door

The appliance doors/pull-out units are aligned at the factory.

If the vertical door gap or the gap between the fridge section and freezer section is not even, you can align the appliance doors/pull-out units.

Align the freezer zone door on the bottom hinge bracket as described below:

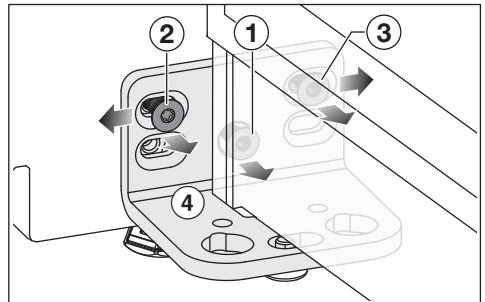

- Open the appliance door.
- Remove the screw ①. It is no longer required.
- Loosen the screw ②.
- Use a short offset screwdriver to loosen the screw ③.
- Depending on the desired position of the appliance door, move the appliance door with the hinge bracket to the left or right.
- Tighten the screws ② and ③ as soon as the desired position is reached.

# Installation

## Electrical connection

The refrigeration appliance must only be connected to an earthed socket using the mains connection cable supplied.

The socket must be easily accessible after the refrigeration appliance has been installed. If the socket is not easily accessible, ensure that a suitable means of disconnection is provided on the installation side for each pole.

 Risk of fire from overheating.

Connecting the refrigeration appliance to a multi-socket plug adapter or to an extension lead can overload the cable.

For safety reasons, do not use an extension lead or multi-socket adapter.

The electrical installation must comply with VDE 0100 requirements.

For safety reasons, we recommend using a type  residual current device (RCD) in the assigned electrical installation for connecting the refrigeration appliance.

If the mains connection cable is damaged, it must only be replaced with a specific mains connection cable of the same type (available from the Miele Customer Service Department). For safety reasons, such replacement may only be carried out by a qualified specialist or the Miele Customer Service Department.

These operating instructions and the data plate indicate the nominal power consumption and the appropriate fuse rating. Compare this information with the data of the on-site electrical connection. If in any doubt, consult a qualified electrician.

Temporary or permanent operation on an autonomous power supply system or a power supply system that is not synchronised with the mains power supply (e.g. island networks, back-up systems)

is possible. A prerequisite for operation is that the power supply system complies with the specifications of EN 50160 or an equivalent standard. The function and operation of the protective measures provided in the domestic electrical installation and in this Miele product must also be maintained in isolated operation or in operation that is not synchronised with the mains power supply, or these measures must be replaced by equivalent measures in the installation. As described, for example, in the current version of VDE-AR-E 2510-2.

## Connection dimensions

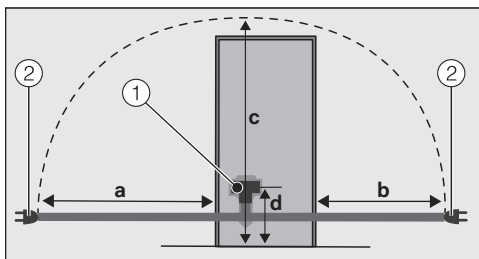

Back of the refrigeration appliance

① Appliance plug connector

② Mains plug

a = approx. 2100 mm

b = approx. 1300 mm

c = approx. 2200 mm

d = approx. 148 mm

## Connecting the refrigeration appliance

■ Plug the appliance plug connector into the socket.

Make sure that the appliance plug connector has clicked into position correctly.

■ Insert the mains plug of the refrigeration appliance into the socket.

The refrigeration appliance is now connected to the mains power supply.

## Appliance dimensions

### Installation dimensions

All dimensions are given in mm.

The refrigeration appliance will function correctly if the specified ventilation cross-sections are kept clear.

The energy consumption was calculated with a distance of 30 mm between the back of the appliance and the wall. If the distance to the wall is less than 30 mm, the functionality of the refrigeration appliance is maintained, but energy consumption increases slightly.

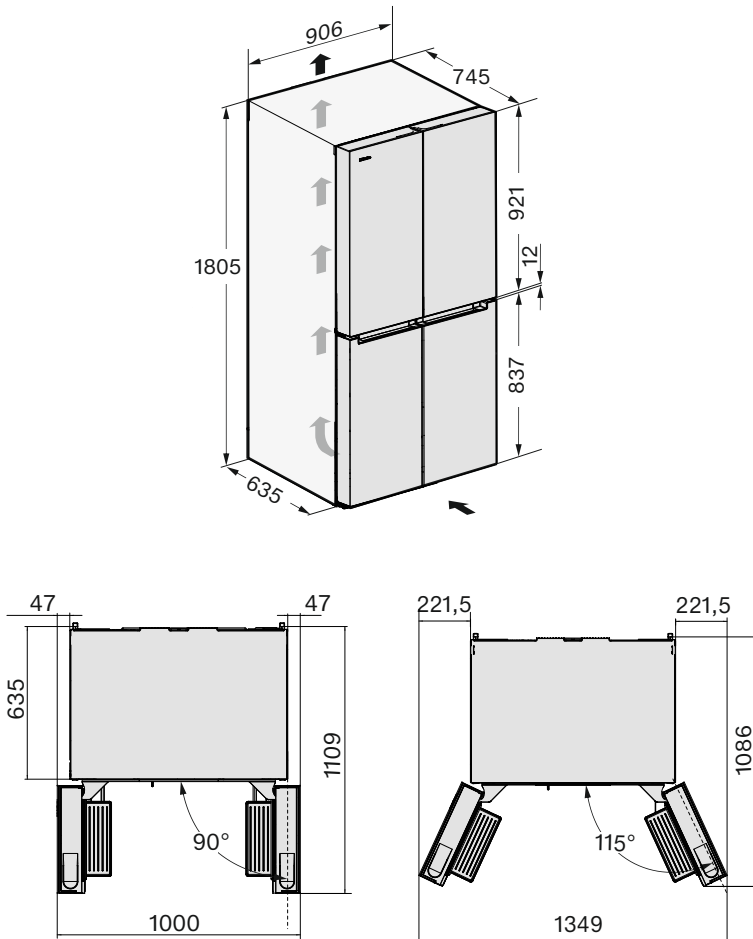

# Installation

---

## Connections

All dimensions are given in mm.

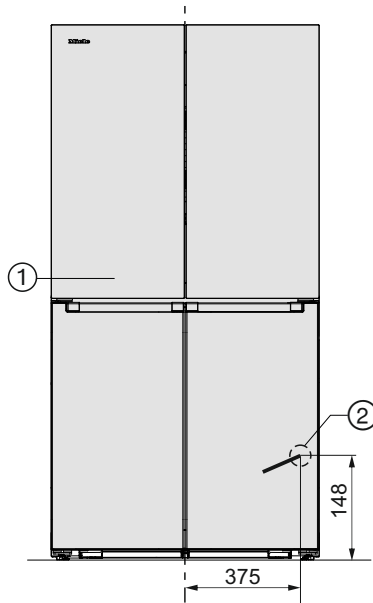

① Front view

② Mains connection cable, length = 2100 mm

A longer mains connection cable is available to order from the Miele Customer Service Department.

## Completely surrounded by kitchen furniture

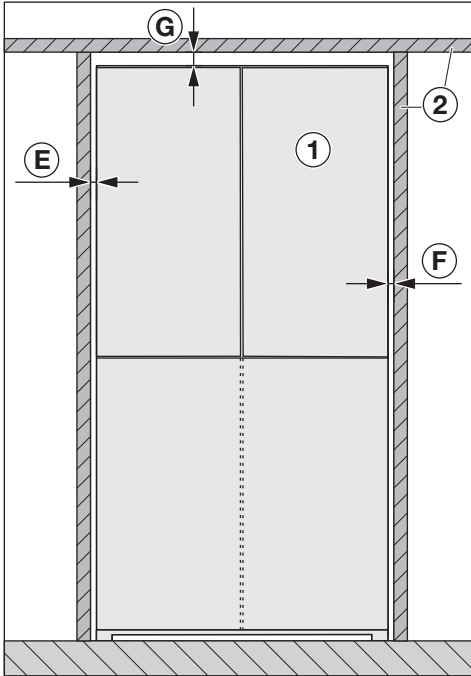

Front view

- ① Refrigeration appliance
- ② Kitchen furniture
- Ⓔ min. 4 mm
- Ⓕ min. 4 mm
- Ⓖ min. 25 mm

⚠ Risk of damage to the appliance door(s).

The appliance doors cannot open wide enough.

The appliance ① must project beyond the front of the adjacent piece of kitchen furniture ② by at least the dimension **B** and the depth **C** of the appliance door.

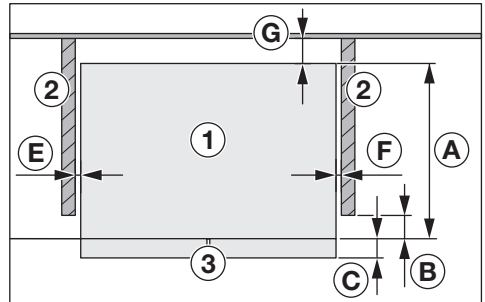

Top view

- ① Refrigeration appliance
- ② Kitchen furniture
- ③ Appliance front
- Ⓐ 635 mm
- Ⓑ 8 mm
- Ⓒ 110 mm
- Ⓔ min. 4 mm
- Ⓕ min. 4 mm
- Ⓖ min. 30 mm

# Installation

## Installation next to a wall

⚠ Risk of damage to the appliance door(s).

The appliance doors could hit the wall of the room resulting in damage to the doors.

The minimum safety distance ⑤ between the refrigeration appliance ① and the room wall ④ is required.

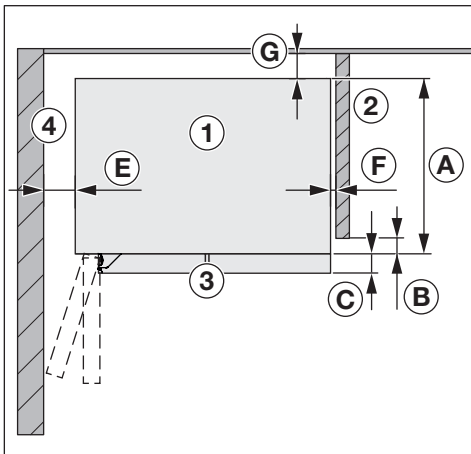

Top view

- ① Refrigeration appliance
- ② Kitchen furniture
- ③ Appliance front
- ④ Room wall
- Ⓐ 635 mm
- Ⓑ 8 mm
- Ⓒ 110 mm
- Ⓔ 100 mm (90° door opening angle)
- Ⓕ 220 mm (115° door opening angle)
- Ⓖ min. 4 mm
- Ⓗ min. 30 mm

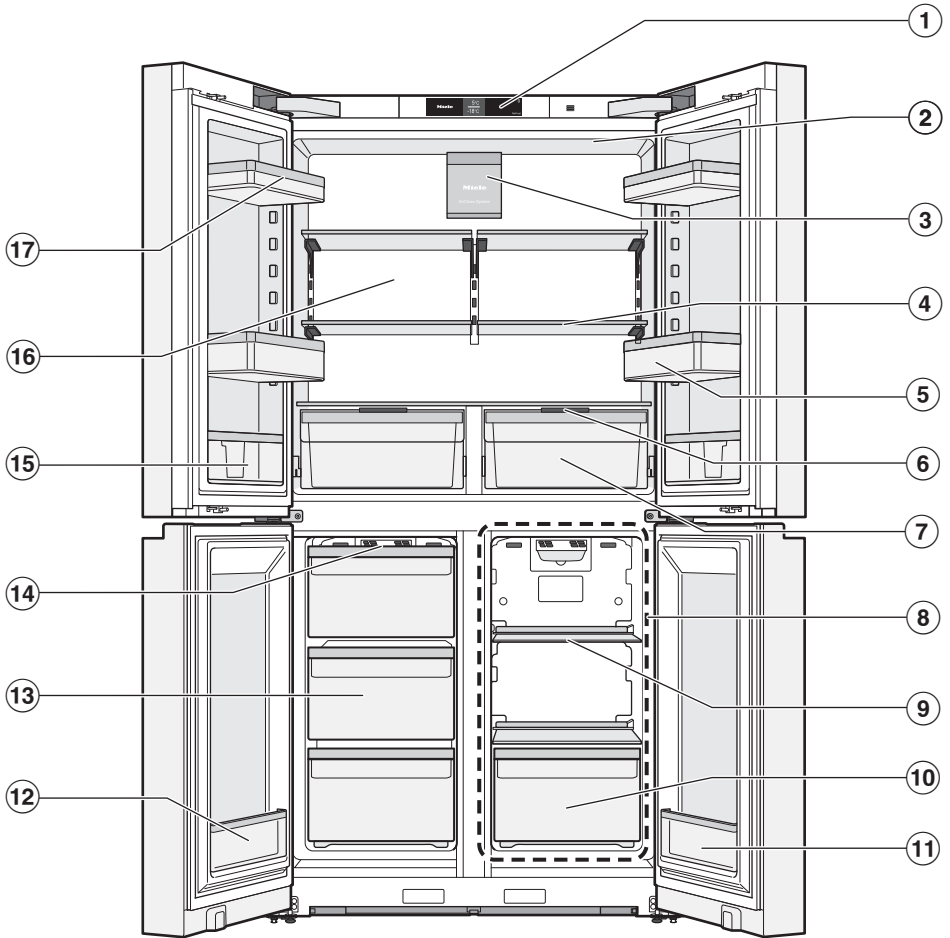

# Familiarisation

---

- ① Display
- ② Top interior lighting
- ③ Fan with charcoal filter (AirClean System)
- ④ Adjustable shelf
- ⑤ Bottle shelf with movable bottle holder (divider):  
Place large bottles and containers here. The bottle holder provides a more secure hold for smaller bottles when opening and closing the appliance door.
- ⑥ Compartment lid for setting the humidity level in the DailyFresh drawer
- ⑦ DailyFresh drawer for vegetables (with moisture adjustment)
- ⑧ Freeze&Cool zone (variable temperature zone):  
For storing a range of food at temperatures between -18 °C and +5 °C.
- ⑨ Freeze&Cool zone shelf
- ⑩ Freeze&Cool drawer (variable temperature zone)
- ⑪ Narrow door shelf:  
For storing small items of food depending on the set temperature.
- ⑫ Narrow door shelf:  
For storing small items of food such as herbs.
- ⑬ Freezer drawer
- ⑭ Ventilation slots:  
When placing food in the respective zone, make sure that the ventilation slots are not blocked.
- ⑮ Narrow door shelf with movable holder:  
For storing small items such as mustard tubes.
- ⑯ Dry rear panel to prevent condensate
- ⑰ Door shelves

## Display

The display can be scratched by pointed or sharp objects, e.g. pens.  
Only touch the display with your fingertips.  
It is possible that the display will not react to finger contact if your fingers are cold.

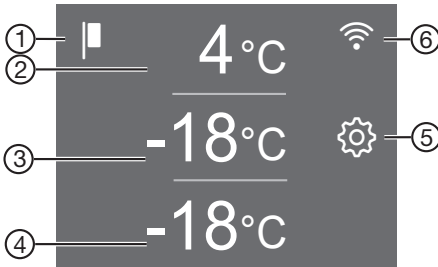



- ① Demo mode display  
(only visible when the Demo mode function has been switched on)
- ② Display the required temperature for the fridge zone, set the temperature from 3 °C to 9 °C, select and deselect the SuperCool & AirClean function ❄️
- ③ Display the required temperature for the freezer zone, set the temperature between -15 °C and -24 °C, select and deselect the SuperFreeze function ❄️
- ④ Display the required temperature for the Freeze&Cool zone (variable temperature zone), set the temperature from -18 °C to +5 °C
- ⑤ Settings mode ⚙️  
sensor control for adjusting various settings in Settings mode
- ⑥ Display for connection status  
(only visible if the network has been set up)

# Familiarisation

## Settings mode

### Party mode

The Party mode function is recommended if you wish to chill or freeze large amounts of fresh food or drink quickly and if you need ice cubes.

When Party mode is switched on, the SuperCool & AirClean <sup>5</sup> and Super-Freeze  functions are activated automatically.

**Tip:** Switch on the Party mode function approx. 4 hours before placing food and drinks in the appliance.

The Party mode function will switch itself off automatically after approx. 24 hours.



If there is a power cut, the Party mode function is switched off.

### Holiday mode

The Holiday mode function is useful when you go on holiday and, for example, you do not wish to switch off the fridge zone completely or do not need a high degree of cooling. In this way, the fridge zone remains in operation while saving energy.

The fridge zone and the PerfectFresh zones are regulated to a temperature of 15 °C.

The freezer zone and the Freeze&Cool zone remain switched on at the previously set temperature.

Previously activated functions such as Party mode  or SuperCool & AirClean  are deactivated.

Food which does not go off quickly can be stored in the refrigeration appliance for some time at this moderate refrigerator temperature, providing it is **wrapped**.

This also prevents the build-up of odours and mould, which can occur if the fridge zone is switched off and the appliance door is closed.

 Health risk caused by decomposing food.

The shelf life and quality of food in the fridge zone may deteriorate if the temperature remains above 4 °C for an extended period.

Only ever switch on the Holiday mode function for a limited period.

Do not store any temperature-sensitive food which goes off easily, such as fruit, vegetables, fish, meat and dairy products, during this time.

Once you have switched off the function, clean the fridge zone and reactivate the charcoal filters.

### Lock function /

When the lock function is switched on, it protects the refrigeration appliance from being switched off unintentionally and being adjusted unintentionally by unauthorised persons, e.g. children.

If you just want to quickly adjust the temperature, for example, you can deactivate the lock function temporarily in Settings mode .

### Switching the refrigeration appliance off

See “Commissioning – Switching off the refrigeration appliance”.

## Sabbath mode

The refrigeration appliance offers a Sabbath mode for the purposes of religious observance.

When Sabbath mode is switched on, the following are deactivated temporarily:

- Interior lighting
- All visual and audible signals
- The display
- An active WiFi connection
- Reminders (e.g. AirClean System filter indicator): the set time interval is paused

All other functions switched on previously remain activated.

## Information on Sabbath mode

You can call up the Sabbath mode version here.

## Time before door alarm is triggered

You can set the time before the door alarm is triggered after opening the appliance door/drawer here.

## Networking

Here you can set up networking for the first time, deactivate and activate the WiFi or reset the network configuration (see “Adjusting settings”).

## Keypad tone /

You can switch the keypad tone on or off here.

## Alarms and buzzers /

You can change the volume of the alarms and buzzers (e.g. in the event of a door alarm or a fault message) here.

Alternatively, you can switch the alarms and buzzers off completely if you find them annoying.

## Display brightness

You can adjust the display brightness to the lighting conditions in the room here.

## Temperature unit $^{\circ}\text{C}/^{\circ}\text{F}$

You can set the required temperature unit ( $^{\circ}\text{C}$ elsius or  $^{\circ}\text{F}$ ahrenheit) here.

## Demo mode

Demo mode allows the refrigeration appliance to be presented in the dealer showroom without the cooling system being switched on. This setting is not needed for domestic use.

You can switch off demo mode here if it has been switched on as a default setting ( will appear on the display).

## Factory defaults

You can reset the refrigeration appliance's settings to the default settings.

**Tip:** Reset the refrigeration appliance's settings to the default settings when disposing of your refrigeration appliance, selling it or putting a used refrigeration appliance into operation. This will reset the network configuration so that your personal data is deleted from the refrigeration appliance. This will also ensure that a previous owner is no longer able to access the refrigeration appliance.

## Information on the refrigeration appliance

You can call up the model identifier and serial number of your refrigeration appliance here.

# Familiarisation

Keep this appliance data to hand:

- For integrating the refrigeration appliance into your WiFi network
- When reporting an appliance fault to the Miele Customer Service Department (see “Customer Service Department”)
- When retrieving information from the EPREL database (see “Customer Service Department”)

## Charcoal filter (AirClean System) indicator

Filtering the air through the Active AirClean filter ensures that the air remains free from dust and odours.

The yellow charcoal filter indicator  on the display reminds you to reactivate the charcoal filters approximately every 6 months.

If the charcoal filters have already been reactivated 5 times, the  symbol will light up yellow on the display to remind you to replace the charcoal filters.

You can activate the reminder function here.

## Cleaning mode

The cleaning mode function makes it easier to clean the fridge zone.

The interior lighting remains switched on, even though the fridge zone is switched off. Audible and visual signals are likewise switched off.

# Safety

## Temperature alarm in the freezer zone

The refrigeration appliance has been fitted with a temperature alarm so that the temperature in the freezer zone cannot rise unnoticed.

If the temperature becomes too warm,  will light up red in the temperature display of the freezer zone. An alarm will also sound until the cause of the alarm is rectified or the alarm is switched off.

The set temperature determines when the appliance recognises a temperature as being too warm.

The audible and visual signals may be activated in the following situations:

- You switch on the refrigeration appliance and the temperature in the freezer zone differs greatly from the set temperature.
- Too much warm ambient air enters the freezer when you are rearranging or taking out frozen food.
- You are freezing large amounts of food at once.
- You are freezing warm food.
- There was a power cut.
- The refrigeration appliance has a fault.

 Health risk caused by decomposing food.

If the temperature in the freezer remains above  $-18\text{ }^{\circ}\text{C}$  for a long time, the frozen food can start to defrost. This will reduce the storage life of the food.

Check whether the frozen food has started to defrost. If it has, check that the food is safe to use and if it is, then use it as soon as possible or cook it before freezing it again.

## Switching the temperature alarm off early

Before you switch the temperature alarm off, you must determine the cause and rectify it.

If you are bothered by the sound of the alarm, you can switch the alarm off early.

- Tap the  symbol.

The  symbol will go out and the alarm will stop.

The freezer zone temperature display will flash for approx. 1 minute to show the warmest temperature measured so far. The current temperature then appears.

## Door alarm

To prevent energy loss when the appliance door is open, the refrigeration appliance is equipped with a door alarm. This prevents food becoming warm if the door is left open.

If an appliance door is left open for a longer period of time,  will light up yellow on the relevant temperature display. An alarm also sounds.

The time until the door alarm is triggered can be customised in Settings mode . The audible alarm can also be switched off.

The alarm will stop and  will go out on the display as soon as the appliance door is closed.

## Switching the door alarm off early

- Tap the  symbol.

The alarm will stop, the  symbol will go out and the interior lighting will light up again constantly.

If the appliance door is not closed, the door alarm will sound again after around 1 minute.

# Familiarisation

## Appliance functions

### SuperCool & AirClean ❄️

When switched on, the SuperCool & AirClean function ❄️ can be used to rapidly reduce the temperature in the **fridge zone** to its lowest setting (depending on the ambient temperature). The refrigeration appliance will work at full power and lower the temperature. Select this function for the rapid chilling of large amounts of fresh food or drink.

If you want to rapidly chill large amounts of fresh food or drinks, switch on the SuperCool & AirClean function ❄️ **immediately before placing items inside.**

**Tip:** You should also activate the SuperCool & AirClean function ❄️ temporarily if you are storing strong-smelling food in the fridge zone. When the SuperCool & AirClean function ❄️ is selected, the charcoal filters work even harder to further reduce odours in the fridge zone.

The SuperCool & AirClean function ❄️ will switch itself off automatically after approx. 18 hours.

### SuperFreeze ❄️

When switched on, the SuperFreeze function ❄️ can be used to rapidly reduce the temperature in the **freezer zone** to its lowest setting (depending on the ambient temperature). The refrigeration appliance will work at full power and lower the temperature. Select this function before freezing fresh food. This helps food to freeze quickly and retain its nutrients, vitamins, flavours and appearance.

The SuperFreeze ❄️ function must be switched on approx. **6 hours before the food to be frozen is placed in the freezer** (see “Operation” section, “Switching on SuperFreeze ❄️”). When you are freezing the **maximum amount of food**, the SuperFreeze function ❄️ should be switched on **24 hours beforehand.**

The SuperFreeze function ❄️ will switch itself off automatically after a maximum of 72 hours. The quantity of fresh food placed in the freezer will determine the duration before it switches off.

## Adjusting the interior fittings

### Maximum load weights

- Top left and right appliance door: 12 kg
- Bottom left and right appliance door: 1 kg
- Top and middle freezer drawer: 15 kg
- Bottom freezer drawer: 10 kg

### Removing and moving the door shelves/bottle shelf

Only move the door shelves/bottle shelves in the appliance door when they are empty.

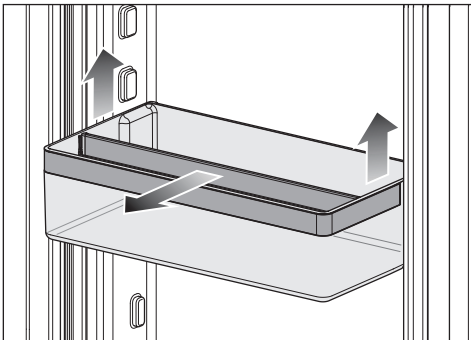
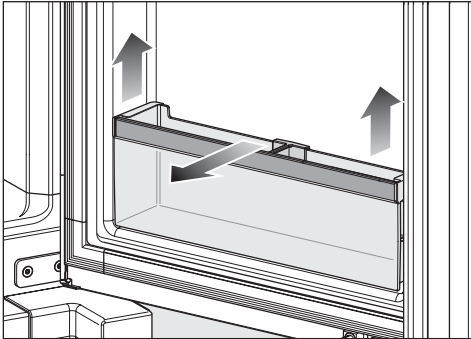

- Push the door shelves/bottle shelves upwards, then remove them by pulling them forwards.

### Adjusting the holders in the door shelf/bottle shelf

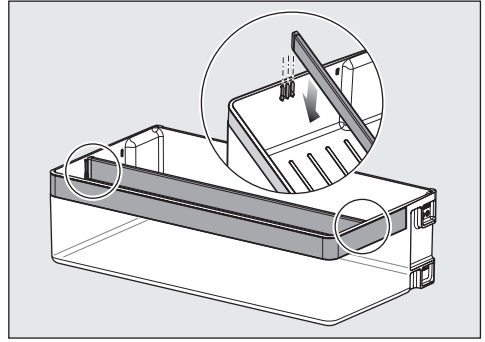

- Pull the divider upwards and set it to the desired position.

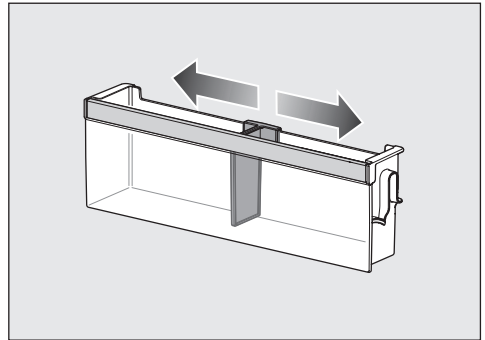

- Move the holder to the right or left.

# Familiarisation

## Removing or moving the shelves

The retainers for the shelves can scratch the rear panel of the fridge zone if they are attached at an angle. Take care to install the shelves horizontally and hook the retainers in fully.

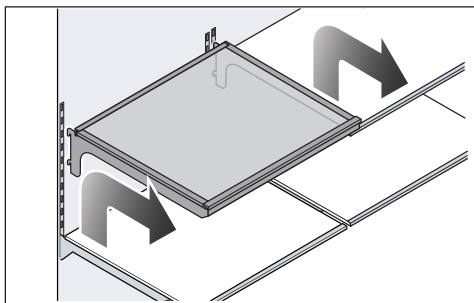

- Raise the shelf slightly so that it is lifted with the retainers over the guide at the back.
- Pull the shelf out to the front.
- Remove the shelf or place the shelf in the required position, with the retainers engaged in the guide.

## Removing the drawers from the fridge zone

- Pull the drawer out as far as it will go.

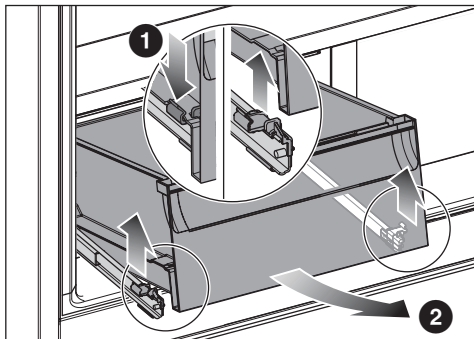

The drawer is secured by retainers at the front. These retainers must be released before removal.

- Press the retainers ① outwards slightly on the left and right at the same time.

The drawer detaches from the telescopic runners.

- Lift the drawer at the front ② and remove it forwards.

Push the telescopic rails back in again to avoid damaging them.

## Inserting the drawers in the fridge zone

- Pull the telescopic runners all the way out.

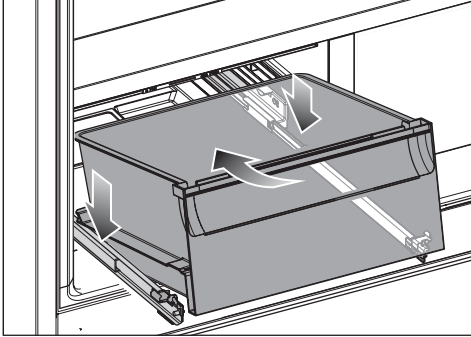

- Position the drawer from above at an angle onto the rear of the telescopic runners, then lower the drawer at the front.

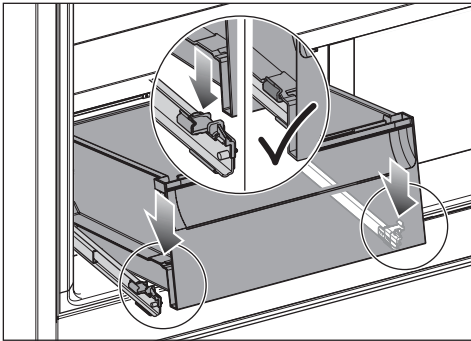

- Grasp one telescopic runner at a time from below and push it forwards until you hear it click into place.
- Push the drawer in.

## Removing the freezer drawer/ Freeze&Cool drawer

If there is insufficient air circulation, the cooling performance will decrease and energy consumption will increase.

Do not remove the bottom drawer from the refrigeration appliance.

Do not cover the ventilation slots in the rear panel.

**Tip:** If you remove the drawer, you can use the glass plate underneath as a shelf.

- Pull the drawer out as far as it will go.
- Lift the drawer at the front and pull it out.

## Inserting the freezer drawer/ Freeze&Cool drawer

- Insert the drawer into the refrigeration appliance from an angle.
- Push in and lower the drawer.

## Removing a glass plate

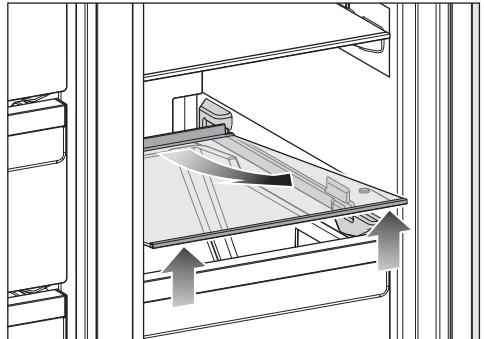

- Lift the glass plate at the front.
- Pull the glass plate out to the front.

# Familiarisation

## Inserting a glass plate

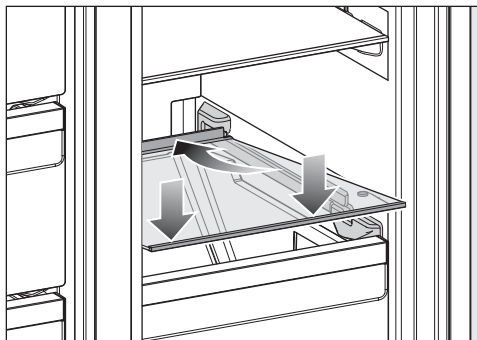

- Place the glass plate behind the stoppers at an angle.
- Lower the glass plate.
- Slide the glass plate backwards.



## Accessories supplied

### Ice cube tray

### Appliance plug

### Charcoal filter (Longlife AirClean system)

The charcoal filters neutralise unpleasant odours in the fridge zone and stop odours from being transferred to the food.

**Tip:** We recommend selecting the SuperCool & AirClean function  temporarily if you are storing strong-smelling food in the fridge zone. When the SuperCool & AirClean function  is selected, the charcoal filters work even harder to further reduce odours in the fridge zone.

The charcoal filters can be reactivated in the oven or a similar domestic appliance with an oven function in a sustainable way and used again (a notification re-

minding you to reactivate them appears on the display approximately every 6 months).

The charcoal filters can be reactivated approximately 5 times; they must be replaced with new ones after approximately 3 years. A notification on the display will remind you to do so.

Used charcoal filters can be disposed of with normal household waste.

New charcoal filters are available from the Miele Customer Service Department, your Miele dealer or via the Internet (see “Familiarisation”, “Optional accessories”).

## Optional accessories

A range of useful Miele accessories and care products are available for your appliance.

Products specially tailored to your refrigeration appliance – such as appliance care products and accessories – are available from the Miele online shop, from Miele Customer Service or from your Miele specialist dealer.

You can access the Miele online shop via the following QR code:



## Before using for the first time

- Remove all packaging material and protective foil.
- Remove all advertising materials and labels from the inside of the refrigeration appliance.
- Clean the inside of the appliance and the accessories.

## Connecting the refrigeration appliance

- Connect the refrigeration appliance to the mains power supply as described in “Installation – Electrical connection”.

Miele will appear on the display, followed by the  symbol.

## Inserting charcoal filters (AirClean System) into the fridge zone

 Risk of mould.

For hygiene reasons, the charcoal filters must not be left in the fridge zone for more than 6 months without being reactivated or replaced.

Place the charcoal filters in the fridge zone just before commissioning the refrigeration appliance.

To improve the quality of the charcoal filters, reactivate them before inserting them into the fridge zone for the first time.

Please follow the instructions in “Cleaning and care – Reactivating the charcoal filters (AirClean System) in the oven”.

Your refrigeration appliance is supplied with 2 charcoal filters in the fridge zone.

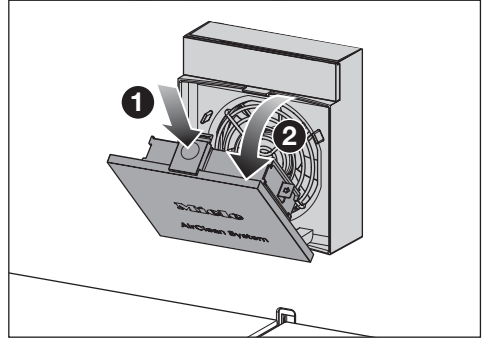

- Press into the recess on the yellow opening tab **1** above the fan cover and open the cover **2**.

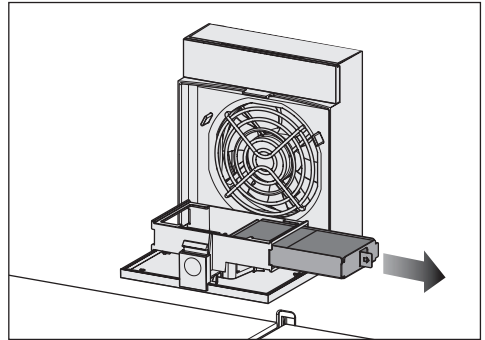

- Remove the retainer for the charcoal filters from the holder.
- To **replace** the charcoal filters, remove the used charcoal filters from the retainer and dispose of them with normal household waste.

Please note: do not dispose of the retainer as it will be reused.

- Clean the retainer under running water and then dry it with a cleaning cloth.

The charcoal filters contain active charcoal. Active charcoal can leave significant marks.

# Commissioning

Before using the charcoal filters, check them for any visible damage. Never use a damaged charcoal filter.

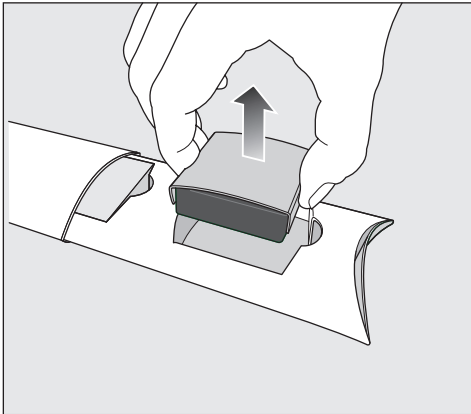

- Take the charcoal filters out of their packaging together with the filter protection.

**⚠** Risk of damage as a result of incorrect handling.

The charcoal filters are breakable. When handling the charcoal filters, be careful not to drop them. Do not press down on the honeycomb structure of the charcoal filters.

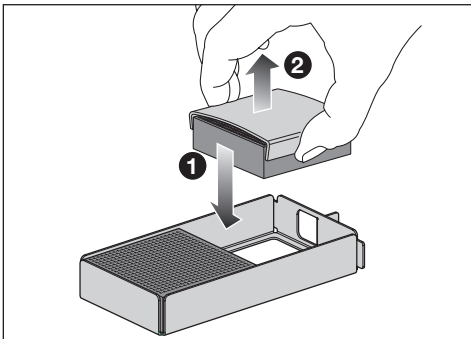



- Insert the new charcoal filters **1** into the retainer one after the other.
- Remove the filter protection **2**.

- Place the retainer with the charcoal filters into the holder.
- Close the fan cover.
- Wash your hands with soap and water after inserting the charcoal filters.

The charcoal filters must be reactivated or replaced every 6 months (see “Cleaning and care – Reactivating the charcoal filters (AirClean System) in the oven”).

A notification on the display will remind you to do so.

**Tip:** Activate the SuperCool & AirClean function  temporarily if you are storing strong-smelling food in the fridge zone. When the SuperCool & AirClean function  is selected, the charcoal filters work even harder to further reduce odours in the fridge zone.

## Switching the refrigeration appliance on

- Open the appliance door.
- Tap the  symbol on the display.

The refrigeration appliance will start to cool and the interior lighting will come on.

When the set freezer temperature is reached, the  symbol disappears, the temperature display of the freezer zone lights up constantly and the alarm tone stops.

- If the alarm bothers you, tap the  symbol.

The alarm will stop.

The refrigeration appliance will gradually reach the pre-set temperatures.

To enable the temperature to get sufficiently cold inside the refrigeration appliance, allow the appliance to run for a few hours before placing food in it. Do not place food in the refrigeration appliance until it has reached the preset temperature.

Do not place food in the freezer zone until it has reached the preset temperature (min. -18 °C).

## Networking

Your refrigeration appliance is equipped with an integrated WiFi module. The WiFi module makes it possible to connect to your home network and to use the Miele app on a mobile device.

Once your refrigeration appliance has been connected via WiFi, the connection is automatically re-established every time it is switched on.

Make sure that your WiFi network signal is strong enough in the place where you intend to install your refrigeration appliance.

Connecting your refrigeration appliance to your WiFi network will increase energy consumption, even when the appliance is switched off.

## Smart Extras via the Miele app\*

Networking via the Miele app gives you access to numerous Smart Extras, including:

- Access status information.
- Use additional helpful functions.
- Keep your refrigeration appliance up to date with the latest Miele developments via software updates.

You can find more detailed information about Smart Extras on the Miele website, in the Apple App Store® or in the Google Play Store™.

\*This is a separate digital offer from Miele & Cie. KG. The range of functions can vary depending on the model and the country. Acceptance of the Terms and Conditions and Privacy Policy for Miele digital products & services in the Miele app required. Miele reserves the right to change or discontinue the digital offer at any time.

## Requirements for networking

Note the following requirements for networking:

1. A home network is available at the installation site.  
Have the WiFi password ready.
2. The Miele app is available on a mobile device.

# Commissioning

3. You have a user account in the Miele app.

## Miele App

The Miele App is available to download free of charge from the Apple App Store® or from the Google Play Store™.



## Performing Scan & Connect

- Scan the QR code.

If you have installed the Miele app and have a user account, you will be taken directly to the networking steps.

If you have not yet installed the Miele app, you will be taken to the Apple App Store® or the Google Play Store™.

- Install the Miele app and set up a user account.
- Scan the QR code again.

The Miele app will guide you through the setup process.



## Switching the refrigeration appliance off

Please note: The refrigeration appliance is not disconnected from the mains power supply when it is switched off.

You can switch the entire refrigeration appliance off in Settings mode ⚙️.

- Tap the ⚙️ symbol.
- Swipe left or right until the ⏻ symbol is shown in the middle.
- Tap the ⏻ symbol.

The cooling system and the interior lighting are switched off.

The ⏻ symbol will appear on the display.

## Switching off the fridge zone, freezer zone or Freeze&Cool zone separately

- Tap the temperature display of the temperature zone you wish to switch off.
- Swipe right until the ⏻ symbol is shown in the middle.
- Tap the ⏻ symbol.

The temperature display for the selected temperature zone will go out. The ⏻ symbol will appear on the display.

The selected temperature zone is switched off.

## Switching the fridge zone, freezer zone or Freeze&Cool zone back on again separately

- Tap the temperature display of the temperature zone you wish to switch on.
- Tap the  symbol.

The selected temperature zone switches back on.

## Switching off for longer periods of time

If, during a long absence, the refrigeration appliance is switched off but not cleaned and the door is left shut, there is a danger of mould building up inside the appliance.

It is essential to clean the refrigeration appliance before a long period of absence.

If the refrigeration appliance is not going to be used for a longer period of time, observe the following:

- Switch the refrigeration appliance off.
- Switch off at the wall and disconnect the plug from the socket, or disconnect the fuse.
- Clean the refrigeration appliance and leave the door ajar to air the appliance and avoid odours building up inside.

It is also advisable to carry out the last instruction if you are switching off one zone by itself for a longer period of time.

# Operation

## Temperature display

In normal operation, the temperature display shows the **current average refrigerator section temperature** and the **maximum freezer section temperature**.

Depending on the ambient temperature and the temperature setting, it can take the appliance a few hours to reach the temperature required and for this temperature to then be shown as a constant temperature on the display.

The temperature in the refrigeration appliance will always **rise**:

- The more often the appliance door is opened and the longer it is kept open.
- The more food is stored in it.
- The warmer the food is which is being put into it.
- The higher the ambient temperature surrounding the refrigeration appliance. This refrigeration appliance is designed for use within specific ambient temperatures (climate range). Do not use in ambient temperatures for which it is not designed.

## Temperature range in the fridge zone

We recommend a temperature of **4 °C** in the fridge zone.

A temperature setting of 4 °C combined with appropriate hygiene measures delays the propagation of bacteria, e.g. salmonella and listeria, which can lead to serious food poisoning.

The **temperature in the fridge zone** can be adjusted from **3 to 9 °C**.

## Temperature range in the freezer zone

 Health risk caused by decomposing food.

To freeze fresh food, a temperature of **-18 °C** is required. Please note that, if the temperature is any warmer, the food will have a shorter shelf life.

When freezing food and storing it over the long term, set a minimum temperature of **-18 °C**.

**Tip:** By keeping the freezer zone at a constant temperature of -18 °C and taking appropriate hygiene measures you can maximise the storage life of your food and avoid food waste.

The **temperature in the freezer zone** can be adjusted from **-15 °C to -24 °C**.

## Temperature range in the Freeze&Cool zone

 Health risk caused by decomposing food.

To freeze fresh food, a temperature of **-18 °C** is required. Please note that, if the temperature is any warmer, the food will have a shorter shelf life.

When freezing food and storing it over the long term, set a minimum temperature of **-18 °C**.

**Tip:** By keeping the temperature constant at -18 °C and taking appropriate hygiene measures you can maximise the storage life of your food and avoid food waste.

The **temperature in the Freeze&Cool zone** can be adjusted from **-18 °C** to **+5 °C**.

## Setting temperatures in the various zones



- Tap the temperature display for the zone you want to change.
- Swipe left or right until the temperature you want is shown in the middle.
- Tap the temperature you want to confirm.

The temperature display will then change back to the current refrigeration and freezer temperature in the refrigeration appliance.

## Switching on SuperCool & AirClean

The SuperCool & AirClean function  must be switched on **before placing** large amounts of food or drinks in the fridge zone.



When the function is switched on, the appliance may make more noise than usual.

- Tap the SuperCool & AirClean symbol  on the temperature display for the fridge zone.
- The  symbol will light up orange.
- Tap the temperature display to leave this Settings level.

## Switching off SuperCool & AirClean

The SuperCool  function will switch itself off automatically after approx. 18 hours. The refrigeration appliance will then run at normal power again.

**Tip:** To save energy, you can switch the function off yourself before this time.

- Tap the SuperCool & AirClean symbol  on the temperature display for the fridge zone.
- The  symbol no longer lights up orange.
- Tap the temperature display to leave this Settings level.

# Operation

## Switching SuperFreeze ❄️ on

The SuperFreeze function ❄️ should be switched on around **6 hours before placing food in the freezer**. When you are freezing the **maximum amount of food**, the SuperFreeze function ❄️ should be switched on **24 hours beforehand**.

You do **not** need to switch on the SuperFreeze function:

- If you are placing food that is already frozen in the freezer
- If you only freeze up to 2 kg of fresh food daily

■ Tap the SuperFreeze symbol ❄️ on the temperature display for the freezer zone.

The ❄️ symbol will light up orange.

■ Tap the temperature display to leave the Settings level.

## Switching SuperFreeze ❄️ off

The SuperFreeze function ❄️ will switch itself off automatically after a maximum of 72 hours.

**Tip:** To save energy, you can switch the function off yourself before this time.

■ Tap the SuperFreeze symbol ❄️ on the temperature display for the freezer zone.

The ❄️ symbol no longer lights up orange.

■ Tap the temperature display to leave the Settings level.

## Storing food in the fridge zone

### Different storage zones

Due to natural air circulation, there are different temperature regions in the refrigerator section.

Cold, heavy air sinks to the lowest section of the refrigeration section. Make use of the different zones when placing food in the appliance.

This is a refrigeration appliance with automatic temperature distribution (DynaCool). The refrigeration appliance switches the fan on automatically when the cooling system for the fridge zone switches on. This means that the cold is distributed evenly in the fridge zone and the difference between the various temperature zones is less pronounced. All stored food is thus cooled to approximately the same temperature.

### Warmest area

The warmest area in the refrigerator section is at the top in the front area and in the door. Use this for storing butter and cheese.

### Coldest area

The coldest area in the fridge zone is directly above the DailyFresh drawer and at the rear panel of the appliance.

Therefore, you should use these areas to store all delicate and highly perishable food, including:

- Fish, meat, poultry
- Cold cuts, ready meals
- Dishes or baked goods containing eggs or cream
- Fresh dough, cake mixtures, pizza or quiche dough

- Raw milk cheese and other raw milk products
- Hummus, vegetable spreads, plant-based cream cheese substitutes
- Pre-packed vegetables
- Other fresh food (with a label stating it should be kept at a temperature of approx. 4 °C)

## Should food be stored loose or in packaging?

Ensure that food stored in the fridge zone is in packaging or covered properly (some exceptions apply in the DailyFresh drawer).

This will prevent food odours from affecting other food, stop food from drying out and also prevent any cross-contamination of germs. This is particularly important when storing meat products. Make sure that food such as raw meat and fish in particular does not come into contact with other food.

By ensuring that the temperature settings are correct and by taking appropriate hygiene measures, you can prolong the storage life of your food considerably. This prevents food waste.

## Protein-rich food

Please note that food rich in protein deteriorates faster than other types of food. Shellfish, for example, deteriorates faster than fish, and fish deteriorates faster than meat.

## Storing food in the DailyFresh drawer

The DailyFresh drawer provides good storage conditions for fruit and vegetables.

The humidity level in the DailyFresh drawer can also be regulated to suit the food being stored. Food retains its own moisture if stored at a higher humidity and so does not dry out as quickly. The temperature is approximately equivalent to the temperature in the fridge zone.

Remember that the fresher the food when placed in the appliance, the longer it will stay fresh.

## Adjusting the humidity level in the DailyFresh drawer for fruit and vegetables

The moisture level greatly depends on the type and quantity of food being stored, if stored unwrapped. If the quantity of food being stored in this compartment is small, the humidity level may be too low.

**Tip:** If you are only storing a small amount of food, wrap it in airtight packaging.

## Selecting low humidity $\Delta$

The appliance is delivered with increased humidity and the compartment cover pushed backwards  $\Delta\Delta\Delta$ .

Only change this position if the DailyFresh drawer is excessively humid:

- Open the DailyFresh drawer.

# Operation

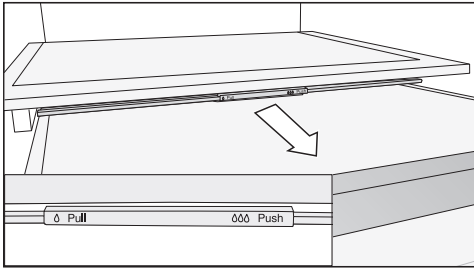

- Pull the compartment cover forwards as far as it will go.

The compartment cover is open and the humidity drops  $\Delta$ .

## Selecting increased humidity $\Delta\Delta\Delta$

- Open the DailyFresh drawer.

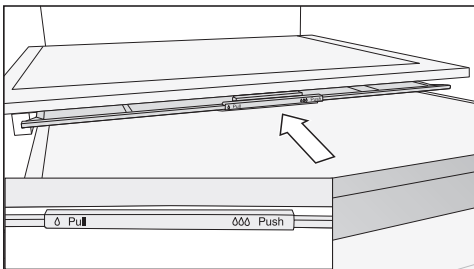

- Slide the compartment cover backwards as far as it will go.

The compartment cover is closed and the humidity remains in the compartment  $\Delta\Delta\Delta$ .

## Storing food in the Freeze&Cool zone

### Choosing the right setting

Always store food **wrapped** in the Freeze&Cool zone.

- Remove any food that is unsuitable for the selected temperature setting.
- Select the required temperature setting.

After changing the temperature, wait a little while for the Freeze&Cool zone to reach the correct temperature.

- Make sure that the temperature is not too hot or too cold before placing food in the drawer.

### Storage recommendation for the Freeze&Cool zone

#### -14 °C to -18 °C

Remove all food from the drawer that is **not** to be frozen.

In this setting range, the zone becomes a freezer zone.

If the SuperFreeze function  $\text{❄}$  has been selected in the freezer zone, this is transferred to the Freeze&Cool zone.

Make sure that the storage time of the food is not exceeded.

#### -5 °C

Use this setting to prepare ice cream for consumption, for example. This temperature is also suitable for slightly freezing food, e.g. to make it easier to cut fish and meat for sushi or carpaccio.

Remove all frozen food unless the food needs to be thawed for consumption or further preparation.

**Caution:** Remove all food that is **not** suitable for storage at -5 °C.

**Caution:** This temperature is **not** suitable for permanent freezing or long-term storage of food.

**Caution:** Consume the food afterwards. **Do not** refreeze the food.

## -2 °C to 0 °C

Use this setting to store food that spoils easily, such as fish and shellfish.

Remove all frozen food first unless the food needs to be thawed.

## 0 °C to 3 °C

Use this setting to store food that spoils easily, such as meat, cold cuts, dairy products or dishes containing eggs or cream.

Remove all frozen food unless the food needs to be thawed.

## 4 °C

This setting turns the zone into a fridge zone.

## Freezing and storing fresh food

### Before placing food in the freezer

Only freeze fresh food which is in good condition.

- When freezing more than 2 kg of fresh food, switch on the SuperFreeze function ❄️ for 6 hours before placing the food in the freezer.
- When freezing even larger amounts of food, switch on the SuperFreeze function ❄️ for 24 hours before placing the food in the freezer.

This helps the frozen food which is already stored in the freezer to stay frozen.

### Placing food in the freezer



Risk of damage due to heavy loads.

Excessively heavy loads can damage the freezer drawers.

Do not exceed the maximum load size:

top and middle freezer drawer = 15 kg

bottom freezer drawer = 10 kg

Unfrozen food should not touch frozen food as this will cause the frozen food to begin to thaw.

- To prevent food sticking together when frozen, make sure that the packaging and containers are dry.

### – Freezing small amounts of food

Freeze food in the top freezer drawer.

- Always place the food as far back as possible in the freezer drawer – close to the rear panel – so that it freezes through to the core as quickly as possible.

# Operation

---

## – Freezing the maximum amount of food (see data plate)

Distribute the food in the upper freezer drawers. Only store food that has already been frozen in the bottom drawer.

- Place the food at the back of the freezer drawer – close to the rear panel – so that it freezes through to the core as quickly as possible.

## After freezing





















- Switch the SuperFreeze ❄️ function off early as soon as food and drinks are sufficiently chilled.

## Cooling drinks quickly

To cool drinks quickly in the fridge zone, switch on the SuperCool & AirClean function ❄️🌀.

To cool larger quantities of drinks or additional bottles in the freezer zone, select the Party mode function 🍷 in the Settings mode ⚙️.

When cooling drinks quickly in the freezer zone, make sure bottles are not left in **for more than one hour**. Otherwise they could burst.



 <b>Settings mode</b>	
	Switch Party mode on or off.
	Switch Holiday mode on or off.
	Switch the locking function on, deactivate it temporarily or switch it off completely.
	Switch off the refrigeration appliance.
	Switch Sabbath mode on or off.
	Call up the Sabbath mode version.
	Change the time before the door alarm is triggered.
	Networking
APP / WPS	Set up networking for the first time.
	Activate or deactivate the WiFi connection.
	Reset the network configuration.
	Switch the keypad tone on or off.
	Change the volume of the alarms and buzzers or switch off the alarms and buzzers completely.
	Adjust the display brightness.
	Change the temperature unit.
	Switch the demo mode off (only visible when switched on).
	Reset the settings to their factory default settings.
	Access information about your refrigeration appliance.
	Activate AirClean System indicator.
	Switch cleaning mode on or off.

# Adjusting settings

The door alarm and other warnings are automatically disabled when the appliance is in Settings mode .

## Switching Party mode on



The Party mode function  should be switched on around 4 hours before placing food in the freezer.

- Tap the  symbol.
- Swipe left or right until the  symbol is shown in the middle.
- Tap the  symbol.

When Party mode is switched on, the  symbol will light up orange.

- To leave the Settings level, tap the  symbol.



When Party mode  is switched on, the following are switched on automatically:

- The SuperFreeze function 
- The SuperCool function 

## Switching Party mode off

The Party mode function  will switch itself off automatically after approx. 24 hours.



To save energy, you can switch off the Party mode function early yourself once food and drinks are sufficiently chilled or enough ice cubes have been made.

- Tap the  symbol.
- Swipe left or right until the  symbol is shown in the middle.
- Tap the  symbol.

When Party mode is switched off, the  symbol will light up white.

- To leave the Settings level, tap the  symbol.

## Switching on Holiday mode

- Tap the  symbol.
- Swipe left or right until the  symbol is shown in the middle.
- Tap the  symbol.

When Holiday mode is switched on, the  symbol will light up orange.

- To leave the Settings level, tap the  symbol.

 Health risk caused by decomposing food.



The shelf life and quality of food in the fridge zone may deteriorate if the temperature remains above 4 °C for an extended period.

Only ever switch on the Holiday mode function for a limited period.

Do not store any temperature-sensitive food which goes off easily, such as fruit, vegetables, fish, meat and dairy products, during this time.

Once you have switched off the function, clean the fridge zone and reactivate the charcoal filters.



## Switching Holiday mode off

- Tap the  symbol.
- Swipe left or right until the  symbol is shown in the middle.
- Tap the  symbol.

When Holiday mode is switched off, the  symbol will light up white.



- To leave the Settings level, tap the  symbol.

## Switching the lock function / on

- Tap the  symbol.
- Swipe left or right until the  symbol is shown in the middle.

- Tap the  symbol.

When the lock function is switched on, the  symbol will light up orange.

- To leave the Settings level, tap the  symbol.
- Close the appliance door. Only then will the lock function  be active.

## Deactivating the lock function / temporarily





- Touch the temperature display for the temperature zone you want to adjust.
- Touch the  symbol for approx. 6 seconds.

The display switches to the temperature controls.

- Now select the required settings.

Closing the appliance door will reactivate the lock function .

## Switching the lock function / off completely



- Tap the  symbol.
- Touch the  symbol for approx. 6 seconds.
- Swipe left or right until the  symbol is shown in the middle.
- Tap the  symbol.

When the lock function is switched off, the  symbol will light up white.

- To leave the Settings level, tap the  symbol.

## Switching Sabbath mode on

When Sabbath mode  is switched on, you cannot change any settings.

- Tap the  symbol.
- Swipe left or right until the  symbol is shown in the middle.

- Tap the  symbol.

The  symbol will light up orange.

- To leave the Settings level, tap the  symbol.

If Sabbath mode  is switched on, this is indicated on the display for approx. 3 seconds.

The display then switches off.

Ensure that the appliance door is properly closed, as visual and audible alarms are switched off.

## Switching Sabbath mode off

The Sabbath mode function  will switch off automatically after approx. 80 hours.

However, you can switch the Sabbath mode function  off early.

- Tap the black display.

The  symbol appears.

- Tap the  symbol.

The  symbol will light up orange.

- Tap the  symbol again.

When Sabbath mode is switched off, the  symbol will light up white.

- To leave the Settings level, tap .

## Changing the time before the door alarm is triggered

- Tap the  symbol.

- Swipe left or right until the  symbol is shown in the middle.

- Tap the  symbol.

- Swipe left or right until the time you want between 30 seconds and 3 minutes 30 seconds is shown in the middle.

# Adjusting settings

---

- Tap to confirm the setting.
- To leave the Settings level, tap the ↩ symbol.

## Setting up networking for the first time

- Tap the ⚙ symbol.
- Swipe left or right until the @ symbol is shown in the middle.
- Tap the @ symbol.
- Tap the connection method you wish to use (app or WPS).

After you have successfully logged in, the 📶 symbol will appear on the display.

If a connection could not be established, the ⊗ symbol will appear.

- In this case, start the process again.
- To leave the Settings level, tap the ↩ symbol.

## Deactivating the WiFi connection

- Tap the ⚙ symbol.
- Swipe left or right until the @ symbol is shown in the middle.
- Tap the @ symbol.
- Tap the 📶 symbol to deactivate the WiFi connection.

The ✖ symbol appears.

- To leave the Settings level, tap the ↩ symbol.

## Activating the WiFi connection







- Tap the ⚙ symbol.
- Swipe left or right until the @ symbol is shown in the middle.
- Tap the @ symbol.
- Tap the ✖ symbol to activate the WiFi connection.

The 📶 symbol appears.

- To leave the Settings level, tap the ↩ symbol.

When the WiFi connection is active, the 📶 symbol will light up on the display.

## Resetting the network configuration









- Tap the  symbol.
- Swipe left or right until the  symbol is shown in the middle.
- Tap the  symbol.
- Swipe right until the  symbol is shown in the middle.
- Tap the  symbol.
- Tap the  symbol.
- To leave the Settings level, tap the  symbol.

All entered settings and values are reset to the default settings.









The WiFi connection has been deactivated. The  symbol will go out on the start display.

Reset the network configuration if you are disposing of or selling your refrigeration appliance, or if you are putting a used refrigeration appliance into operation. All personal data is removed from the refrigeration appliance. This will also ensure that a previous owner is no longer able to access the refrigeration appliance.

## Switching off the keypad tone



- Tap the  symbol.
  - Swipe left or right until the   symbol is shown in the middle.
  - Tap the   symbol.
- If the keypad tone is switched off, the   symbol will light up white.
- To leave the Settings level, tap the  symbol.

## Switching on the keypad tone

- Tap the  symbol.
  - Swipe left or right until the   symbol is shown in the middle.
  - Tap the   symbol.
- If the keypad tone is switched on, the   symbol will light up orange.
- To leave the Settings level, tap the  symbol.

# Adjusting settings

## Changing the volume of the alarms and buzzers /





- Tap the  symbol.
- Swipe left or right until the  symbol is shown in the middle.
- Tap the  symbol.
- Select the volume you want by swiping the segment bar to the left or right (level 1–7).
- If you want to switch the alarms and buzzers off completely, swipe to the left until the segment bar goes out completely.
- Confirm the setting you want by tapping the segment bar.

When the alarms and buzzers are switched off, the  symbol will light up white.



When the alarms and buzzers are switched on, the  symbol will light up orange.

- To leave the Settings level, tap the  symbol.





## Changing the display brightness

- Tap the  symbol.
- Swipe left or right until the  symbol is shown in the middle.
- Tap the  symbol.
- Select the brightness you want by swiping the segment bar to the left or right (level 1–7).
- Confirm the setting you want by tapping the segment bar.
- To leave the Settings level, tap the  symbol.

## Changing the temperature unit °C/°F





- Tap the  symbol.
  - Swipe left or right until °C or °F is shown in the middle.
  - Tap °C or °F to change the temperature unit.
- °C or °F will appear on the display.
- To leave the Settings level, tap the  symbol.

## Switching off demo mode

- Tap the  symbol.
- Tap the  symbol.
- Swipe left or right until the  symbol is shown in the middle.
- Tap the  symbol.



After demo mode  has been switched off, the refrigeration appliance shuts down and must be switched on again.

## Resetting the settings to their factory defaults

- Tap the  symbol.
  - Swipe left or right until the  symbol is shown in the middle.
  - Tap the  symbol.
- The  symbol appears.
- Tap the  symbol.

The refrigeration appliance shuts down and must be switched on again.



## Activating the Active AirClean filter indicator

- Tap the  symbol.
- Swipe left or right until the  symbol is shown in the middle.
- Tap the  symbol.

If the Active AirClean filter indicator is activated, the  symbol will light up orange.

- To leave the Settings level, tap the  symbol.



## Switching on cleaning mode

- Tap the  symbol.
- Swipe left or right until the  symbol is shown in the middle.
- Tap the  symbol.

When cleaning mode is switched on, the  symbol will light up orange.

- To leave the Settings level, tap the  symbol.

## Switching off cleaning mode

- Tap the  symbol.
- Swipe left or right until the  symbol is shown in the middle.
- Tap the  symbol.

When cleaning mode is switched off, the  symbol will light up white.

- To leave the Settings level, tap the  symbol.

# Cleaning and care

The data plate located inside the interior cabinet of the refrigeration appliance must not be removed. It contains information which is required in the event of a service call.

Do not let water get into the electronic unit or the lighting.

 Risk of damage due to moisture ingress.

The steam from a steam cleaner can damage plastic and electrical components.

Do not use a steam cleaner to clean the refrigeration appliance.

## Defrosting

The fridge zone and the DailyFresh drawer defrost automatically.

The refrigeration appliance is equipped with a NoFrost system that defrosts the freezer zone automatically.

## Cleaning agents

Cleaning and conditioning agents used in the interior cabinet of the refrigeration appliance must be food safe.

To avoid damaging the surfaces of the appliance, **do not use the following:**

- Cleaning agents containing soda, ammonia, acids or chlorides
- Cleaning agents containing descaling agents
- Abrasive cleaning agents (e.g. scouring powder, scouring liquid or pumice stones)
- Cleaning agents containing solvents
- Stainless steel cleaners

- Dishwasher cleaner
- Oven sprays
- Glass cleaning agents
- Hard, abrasive sponges and brushes (e.g. pot scourers)
- Eraser stain remover blocks
- Sharp metal scrapers

We recommend using a clean sponge and lukewarm water with a little washing-up liquid to clean the surfaces of the appliance.

## Preparing the refrigeration appliance for cleaning

### Cleaning the fridge zone only:

Use the cleaning mode .

- Take any food out of the fridge zone and store it in a cool place.
- If necessary, take out all removable parts for cleaning.

### Cleaning the freezer zone/the entire refrigeration appliance:

- Switch the refrigeration appliance off.

The  symbol appears on the display and the cooling system is switched off.

- Take any food out of the freezer zone/refrigeration appliance and store it in a cool place.
- If necessary, take out all removable parts for cleaning.

## Cleaning the interior of the appliance

Clean the refrigeration appliance regularly, or at least once a month.

If soiling is left on for any length of time, it may become impossible to remove under certain circumstances. Surfaces may suffer discolouration or damage. It is therefore best to remove any soiling immediately.

- Clean the **interior** with a clean sponge cloth, lukewarm water and a little washing-up liquid.
- After cleaning, wipe with clean water and dry with a cleaning cloth.
- Clean the condensate channel and drain hole using a cotton swab or similar item.
- Leave the door open to air the refrigeration appliance sufficiently for a short while and to prevent odour build-up.

## Cleaning accessories by hand or in the dishwasher

The following components must be cleaned **by hand** only:

- The charcoal filter holder (Longlife AirClean system)
- The stainless steel trims of the bottle shelf
- Adjustable shelf with printing
- All drawers and compartment lids (these vary depending on model)

The following components are **dishwasher-safe**:

 Risk of damage due to high dishwasher temperatures. Parts of the refrigeration appliance may become unusable, e.g. deform, if they are washed in the dishwasher at more than 55 °C. For dishwasher-safe components, always select dishwasher programmes with a maximum temperature of 55 °C.

Contact with natural dyes from carrots, tomatoes and ketchup, etc., may discolour the plastic parts in the dishwasher. This discolouration does not affect the stability of the parts.

- The bottle holder (divider), the ice cube tray
- Shelves and bottle shelves in the appliance door (without stainless steel trim)
- Adjustable shelves (without the trim or printing)

## Removing and dismantling accessories for cleaning

### Dismantling the bottle shelf

Before cleaning the bottle shelf in the dishwasher, remove the bottle holder (divider) and the stainless steel trim.

- Place the bottle shelf on the worktop.
- Pull the bottle holder (divider) upwards out of the bottle shelf.

## Cleaning and care

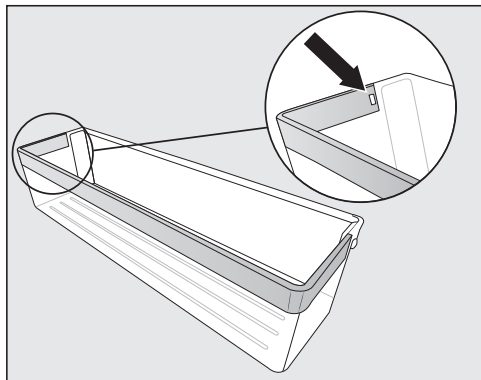

- Press the retainer out of the recess. The entire section of stainless steel trim will now come off the shelf.
- After cleaning, reattach the stainless steel trim to the shelf by following the same procedure in reverse.

### Removing the compartment cover for cleaning and reinserting it

The shelf above and the drawers of the fridge zone have already been removed.

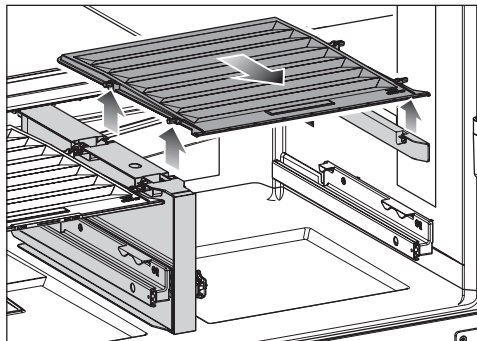

- Lift the cover at the front and pull it out.

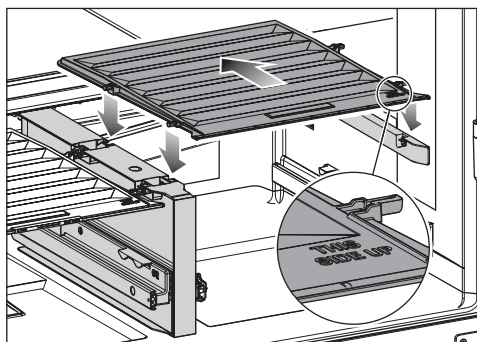

- After cleaning, slide the compartment cover back in again.
- Push the shelf back in as far as it will go and set it down.
- Replace the drawers.

## Cleaning the front of the appliance and the side panels

If soiling is left on for any length of time, it may become impossible to remove. Surfaces may suffer discoloration or damage.

Therefore, it is best to remove soiling from the appliance front and side panels immediately.

All surfaces are susceptible to scratching. Contact with unsuitable cleaning agents can alter or discolour the surfaces.

See the information on “Cleaning agents” at the beginning of this section.

- Clean the surfaces with a clean sponge and a solution of warm water and washing-up liquid. A clean, damp microfibre cloth without cleaning agent can also be used.
- After cleaning, wipe with clean water and dry with a soft cloth.

### CleanSteel (edt/cs) – appliance front

 Risk of damage as a result of incorrect cleaning.

The surface coating will be damaged.

**Do not use a stainless steel cleaner on this surface.**

The appliance front has a high quality, special finish. This finish is resistant to soiling and is very easy to clean.

## Cleaning the door seal

 Risk of damage as a result of incorrect cleaning.

If you treat the door seal with oils or grease, it can become porous.





Do not use any oils or grease on the door seal.

- The door seal should be cleaned regularly with clean water, and then wiped dry with a soft cloth.

## Cleaning the ventilation openings

- The ventilation openings should be cleaned on a regular basis with a feather duster or vacuum cleaner (you could use a Miele vacuum cleaner dusting brush, for example).

## After cleaning

- Replace all shelves and accessories in the refrigeration appliance.
- Switch the refrigeration appliance back on, if necessary.
- Switch the fridge zone cleaning mode  off again, if necessary.
- Switch the SuperFreeze function  on for a while so that the freezer zone can cool down quickly.
- Switch the SuperCool & AirClean function  on for a while so that the fridge zone can cool down quickly.
- Place food in the fridge zone.
- Once the temperature in the freezer zone is cold enough, place the food back in the freezer drawers and put them back in the freezer zone.
- Switch the SuperCool & AirClean function  off once food and drinks are sufficiently chilled.

## Cleaning and care

---

- Switch the SuperFreeze function ❄️ off as soon as the temperature in the freezer zone is a constant  $-18\text{ }^{\circ}\text{C}$  or colder.
- Close the appliance doors.

Many malfunctions and faults can be easily remedied. You can save time and money in many cases, as you do not need to contact Customer Service.

More information to help you remedy faults yourself can be found at [www.miele.co.uk/support/customer-assistance](http://www.miele.co.uk/support/customer-assistance).







To prevent unnecessary loss of temperature it is advisable not to open the door while waiting for the appliance to be serviced.

## Other problems

Problem	Cause and remedy
<b>The refrigeration appliance is not cooling.</b>	The refrigeration appliance has not been switched on. ■ Switch the refrigeration appliance on.
	The mains plug is not inserted in the socket correctly or the plug connector is not inserted into the socket at the back of the appliance correctly. ■ Insert the mains plug into the mains socket and the plug connector into the appliance socket correctly and switch on.
	The mains fuse has tripped. There could be a fault with the refrigeration appliance, the household electrical wiring or another electrical appliance. ■ Contact a qualified electrician or the Miele Customer Service Department.
<b>The compressor runs continuously.</b>	This is not a fault. To save energy, the compressor runs at a lower speed when less cooling is required. This increases the compressor running time.
<b>The compressor is switching on more frequently and for longer periods of time. The temperature in the refrigeration appliance is too low.</b>	The appliance doors have been opened too frequently. Or large amounts of fresh food have been placed in the appliance. ■ Only open the appliance doors when necessary and for as short a time as possible.
	The appliance doors are not closing fully. The temperature in the refrigeration appliance is dropping.





# Troubleshooting

Problem	Cause and remedy
	<p>■ Check that the appliance doors are seated correctly and use the screws in the hinges to adjust them if necessary.</p> <p>The appliance doors are not closed properly. If a thick layer of ice has already formed, this will affect cooling and increase energy consumption.</p> <p>■ Always close the appliance doors fully.</p> <p>■ Defrost the refrigeration appliance if necessary and clean it.</p> <p>The ambient temperature is too high. The higher the ambient temperature, the longer the compressor runs.</p> <p>■ See the information in “Installation – Installation site”.</p> <p>The ventilation openings are covered or dusty.</p> <p>■ Do not block the ventilation openings.</p> <p>■ Dust the ventilation openings regularly.</p> <p>Built-in appliances: the refrigeration appliance was not properly installed in the niche.</p> <p>■ Install the refrigeration appliance in the niche as described in the installation instructions.</p>
<p><b>The compressor is switching on more frequently and for longer periods of time. The temperature in the refrigeration appliance is too low.</b></p>	<p>The ventilation cross-sections are covered or dusty.</p> <p>■ Do not block the ventilation cross-sections.</p> <p>■ Dust the ventilation cross-sections regularly.</p> <p>The appliance doors have been opened too frequently, or a large amount of fresh food has been put in all at once for storage or freezing.</p> <p>■ Only open the appliance doors when necessary and for as short a time as possible.</p> <p>After a while, the temperature will return to normal by itself.</p> <p>The appliance doors are not closed properly. A thick layer of ice may have formed in the freezer zone.</p> <p>■ Close the appliance doors.</p>











Problem	Cause and remedy
	<p>After a while, the temperature will return to normal by itself.</p> <p>If a thick layer of ice has already formed, this will affect cooling and increase energy consumption.</p> <ul style="list-style-type: none"> <li>■ Defrost the refrigeration appliance and clean it.</li> </ul> <p>The ambient temperature is too high. The higher the ambient temperature, the longer the compressor runs.</p> <ul style="list-style-type: none"> <li>■ See the information in “Installation – Installation site”.</li> </ul> <p>The refrigeration appliance was not properly installed in the niche.</p> <ul style="list-style-type: none"> <li>■ Install the refrigeration appliance as described in the installation instructions supplied with it.</li> </ul> <p>The temperature setting in the refrigeration appliance is too low.</p> <ul style="list-style-type: none"> <li>■ Correct the temperature setting.</li> </ul> <p>A large amount of food has been frozen at once.</p> <ul style="list-style-type: none"> <li>■ Refer to the instructions in “Operation – Freezing and storing fresh food”.</li> </ul> <p>The SuperCool &amp; AirClean function  is still switched on.</p> <ul style="list-style-type: none"> <li>■ Switch off the SuperCool &amp; AirClean function  earlier to save energy.</li> </ul> <p>The SuperFreeze function  is still switched on.</p> <ul style="list-style-type: none"> <li>■ Switch off the SuperFreeze function  earlier to save energy.</li> </ul>
<p><b>The temperature in the refrigeration appliance is too high. The frozen food (depending on the model) could defrost.</b></p>	<p>This is not a fault. The temperature setting is too high.</p> <ul style="list-style-type: none"> <li>■ Correct the temperature setting.</li> <li>■ Check the temperature again after 24 hours.</li> </ul> <p>The ambient temperature is too low for this refrigeration appliance. If the ambient temperature is too low, the compressor will run less frequently. The temperature in the refrigeration appliance is rising.</p> <ul style="list-style-type: none"> <li>■ See the information in “Installation – Installation site”.</li> <li>■ Increase the ambient temperature.</li> </ul>

# Troubleshooting



















Problem	Cause and remedy
<b>Ice or condensation has built up inside the refrigeration appliance. The appliance door may not close correctly.</b>	The door seal has come out of its groove. ■ Check that the door seal is correctly positioned in the groove.
	The door seal is damaged. ■ Check whether the door seal is damaged.
<b>The door seal is damaged or needs to be replaced.</b>	The door seal can be partially replaced without tools. ■ Contact the Miele Customer Service Department.
<b>The soft-close mechanism is damaged or needs to be replaced.</b>	The soft-close mechanism can be replaced without tools. ■ Replace the soft-close mechanism. A new soft-close mechanism is available from your specialist dealer or from the Miele Customer Service Department.
<b>Food has frozen together.</b>	The food packaging was not dry when placed in the freezer. ■ Use a blunt instrument, e.g. a spoon handle or plastic scraper, to prise it apart carefully.
<b>The charcoal filter is coming into contact with liquid.</b>	The charcoal filter is coming into contact with liquid when food is being placed into or moved around inside the fridge zone. ■ Remove the charcoal filter from the fridge zone and dispose of it with normal household waste. ■ Dispose of unwrapped food that has been stored underneath the charcoal filter. ■ Clean the cover of the charcoal filter, the filter retainer and its holder in the fridge zone with a clean sponge cloth and lukewarm water. ■ If necessary, clean the surface underneath the charcoal filter. ■ Replace the charcoal filter with a new one.



Problem	Cause and remedy
<p><b>There is no audible alarm even though the appliance door has been open for a long time.</b></p>	<p>This is not a fault. The alarm has been switched off in Settings mode. If you want to switch the audible alarm back on again:</p> <ul style="list-style-type: none"> <li>■ Tap the  symbol.</li> <li>■ Swipe left or right until the  symbol is shown in the middle.</li> <li>■ Tap the  symbol.</li> <li>■ Select the volume you want by swiping the segment bar to the right.</li> <li>■ Confirm the setting you want by tapping the segment bar.</li> </ul> <p>When the alarms and buzzers are switched on, the  orange symbol will light up.</p>
<p><b>The external walls of the appliance feel warm.</b></p>	<p>This is not a fault. The heat created by the evaporator is used to prevent condensation.</p>

## Display warnings







Message	Cause and remedy
<p><b>The  symbol lights up on the start display; the refrigeration appliance does not get cold even though the controls and the interior lighting are working.</b></p>	<p>Demo mode has been switched on.</p> <ul style="list-style-type: none"> <li>■ Tap the  symbol.</li> <li>■ Tap the  symbol.</li> <li>■ Swipe left or right until the  symbol is shown in the middle.</li> <li>■ Tap the  symbol.</li> </ul> <p>After demo mode  has been switched off, the refrigeration appliance shuts down and must be switched on again.</p>
<p><b> is lit up on the display and the appliance cannot be used.</b></p>	<p>The Cleaning mode function is still switched on.</p> <ul style="list-style-type: none"> <li>■ Switch the Cleaning mode function off again by tapping on  on the start display.</li> <li>■ Tap  again.</li> </ul> <p>When Cleaning mode is switched off, the  symbol will light up white.</p> <p>The refrigeration appliance will start cooling again.</p>





# Troubleshooting

Message	Cause and remedy
<p><b>Nothing is visible in the display. The display is completely blank.</b></p>	<p>Sabbath mode  is switched on. The interior lighting is switched off and the refrigeration appliance is cooling.</p> <ul style="list-style-type: none"> <li>■ Tap the black display.</li> </ul> <p>The  symbol will appear in the display.</p> <ul style="list-style-type: none"> <li>■ Tap the  symbol.</li> </ul> <p>The  symbol will light up orange.</p> <ul style="list-style-type: none"> <li>■ Tap the  symbol again.</li> </ul> <p>When Sabbath mode is switched off, the  symbol will light up white.</p>
<p><b>The  symbol is lit up on the display and the refrigeration appliance cannot be used.</b></p>	<p>The lock function has been activated.</p> <ul style="list-style-type: none"> <li>■ Unlock the refrigeration appliance temporarily or switch the lock function off completely.</li> </ul>
<p><b>The  symbol lights up yellow on the display.</b></p>	<p>The charcoal filter indicator  reminds you to reactivate the charcoal filters approximately every 6 months.</p> <ul style="list-style-type: none"> <li>■ Reactivate the charcoal filters and confirm that you have changed the charcoal filters by tapping the  symbol on the display.</li> </ul> <p>The  symbol will go out on the start display.</p>
<p><b>The  symbol lights up yellow on the display.</b></p>	<p>The charcoal filter indicator  reminds you to replace the charcoal filters. This indicator appears when the charcoal filters have already been reactivated 5 times.</p> <ul style="list-style-type: none"> <li>■ Replace the charcoal filters.</li> <li>■ Confirm that you have changed the charcoal filters by tapping the  symbol on the display.</li> </ul> <p>The  symbol will go out on the start display.</p>
<p><b>The  symbol is lit up yellow on the temperature display for the fridge zone and/or the freezer zone; additionally, an alarm is sounding and the interior lighting is pulsating.</b></p>	<p>The door alarm has been activated.</p> <ul style="list-style-type: none"> <li>■ Touch the  symbol on the display for several seconds.</li> </ul> <p>The alarm will stop, the  symbol will go out and the interior lighting will light up again constantly.</p> <ul style="list-style-type: none"> <li>■ Close the relevant appliance door.</li> </ul>

Message	Cause and remedy
<p><b>The  symbol lights up red on the freezer zone temperature display and an alarm also sounds.</b></p>	<p>The temperature alarm has been activated; the temperature in the freezer zone has risen higher than the temperature set.</p> <p>Possible reasons for this include:</p> <ul style="list-style-type: none"> <li>– The appliance door has been opened frequently.</li> <li>– A large quantity of fresh food has been placed in the freezer without the SuperFreeze function being switched on.</li> <li>– A prolonged power cut has occurred.</li> <li>– The refrigeration appliance has a fault.</li> </ul> <p>■ Tap the  symbol.</p> <p>The alarm message is confirmed: the  symbol will go out and the alarm will stop.</p> <p>The warmest temperature recorded in the freezer zone will flash for about 1 minute on the display. Then the temperature display will change to the current temperature in the freezer zone.</p> <p>You can exit from the flashing temperature display early:</p> <p>■ Touch the temperature display for the freezer zone.</p> <p>The warmest temperature display will disappear. The temperature display will then revert to showing the current temperature in the freezer zone.</p> <p>■ Remedy the cause of the alarm.</p> <p>■ Depending on the temperature displayed, you should check whether food in the freezer has started to thaw or has defrosted. If it has, it should be used as soon as possible. Defrosted food may only be re-frozen after it has been cooked.</p>

# Troubleshooting

Message	Cause and remedy
<p>The   symbol lights up red on the display and an alarm sounds.</p>	<p>Indication of a power cut: the temperature in the freezer zone over the last few days or hours has risen too high because of a power cut or interruption to the power supply.</p> <ul style="list-style-type: none"><li>■ Tap the   symbol.</li></ul> <p>The fault message is confirmed: The   symbol will go out and the alarm will stop.</p> <p>The warmest temperature recorded in the freezer zone will flash for about 1 minute on the temperature display for the freezer zone. Then the temperature display will change to the current temperature in the freezer zone.</p> <p>You can exit from the flashing temperature display early:</p> <ul style="list-style-type: none"><li>■ Touch the temperature display for the freezer zone.</li></ul> <p>The warmest temperature display will disappear. The temperature display will then revert to showing the current temperature in the freezer zone. The refrigeration appliance will go back to the last temperature setting when the power is back on.</p> <ul style="list-style-type: none"><li>■ Remedy the cause of the alarm.</li><li>■ Depending on the temperature displayed, you should check whether food in the freezer has started to thaw or has defrosted. If it has, it should be used as soon as possible. Defrosted food may only be re-frozen after it has been cooked.</li></ul>







Message	Cause and remedy
<p>The  symbol lights up red in the display and a fault code F with numbers may appear. An alarm also sounds.</p>	<p>There is a fault.</p> <ul style="list-style-type: none"> <li>■ Tap the  symbol on the display to switch the alarm off.</li> <li>■ Contact the Miele Customer Service Department.</li> </ul> <p>To report the fault, you need the fault code and also the model identifier and serial number of your refrigeration appliance. You can access this information on the display:</p> <ul style="list-style-type: none"> <li>■ Tap the  symbol on the display.</li> </ul> <p>The appliance data required will be shown on the display.</p> <p>Confirm with the  symbol to exit the information display and the fault code will be shown again on the display.</p> <p>The refrigeration appliance can be switched off directly from the fault message display.</p>

# Troubleshooting

## Interior lighting

 Risk of electric shock due to exposed, live electrical components.  
When removing the lighting cover, there is a risk of coming into contact with live electrical components.  
Do not remove the lighting cover. The LED lighting may only be repaired or replaced by the Miele Customer Service Department.

 Risk of injury from LED lighting.  
This lighting corresponds to risk group RG 2. If the cover is defective, there is a risk of eye injury.  
If the lighting cover is defective, do not look from a close range directly into the lighting with optical instruments (e.g. magnifying glass or similar).

Problem	Cause and remedy
<b>The interior lighting is not working.</b>	The refrigeration appliance has not been switched on. ■ Switch the refrigeration appliance on.
	Sabbath mode  is switched on: the display is dark and the refrigeration appliance is cooling. ■ Tap the black display. The  symbol will appear in the display. ■ Tap the  symbol. The  symbol will light up orange. ■ Tap the  symbol in Settings mode  . When Sabbath mode is switched off, the  symbol will light up white.
	To avoid overheating, the interior lighting switches itself off automatically after approx. 15 minutes if the appliance door is left open. If this is not the case, then there is a fault. ■ Contact the Miele Customer Service Department.
<b>The interior lighting is pulsating.</b>	This is not a fault. The door alarm has been activated.

## Noises

The refrigeration appliance is producing various noises during operation.  
If the cooling performance is low, the refrigeration appliance will conserve energy but operate for longer. The volume will be lower.  
Food will be chilled faster if the cooling performance is high.  
The volume will be higher.

## Troubleshooting

Normal noises	What is causing the noises?
<b>Hissing</b>	Refrigerant is being injected into the cooling circuit.
<b>Bubbling, gurgling, splashing</b>	Refrigerant is circulating through the pipes.
<b>Humming</b>	The refrigeration appliance is cooling.
<b>Clicking</b>	The thermostat is switching the compressor on or off.
<b>Humming, whirring</b>	The fan is running. The automatic door opener (depending on the model) is opening or closing the appliance door.
<b>Cracking</b>	Material in the refrigeration appliance is expanding.
<b>Rattling</b>	Valves or flaps are active.
<b>Buzzing (refrigeration appliances with water container)</b>	Water is being pumped out of the water container.
<b>Slurping (refrigeration appliances with soft-close mechanism)</b>	The appliance door with soft-close mechanism is being opened or closed.
Please bear in mind that a certain amount of noise is unavoidable (from the compressor and the refrigerant circulating through the cooling circuit).	

# Troubleshooting

Noises	Cause and remedy
Vibrating, rattling, clinking	The refrigeration appliance is uneven. Use a level to check and adjust the alignment of the refrigeration appliance. The refrigeration appliance is aligned by raising or lowering the adjustable feet (depending on the model) underneath it.  <b>For built-in appliances:</b> For niches of 140 cm and more: place the stabilising rods supplied underneath the appliance base.
	The refrigeration appliance is touching another appliance or piece of furniture. Move it away.
	Drawers, baskets or shelves are jiggling or are stuck. Check all removable items and refit them correctly.
	Bottles or containers are touching. Separate bottles or containers slightly.
	The transport cable clips (depending on the model) are hanging loose at the back of the appliance. Remove the transport cable clips.

Information to help you rectify faults yourself and about Miele spare parts can be found at [www.miele.com/service](http://www.miele.com/service).

## Contact in the event of a fault

In the event of a fault which you cannot remedy yourself, please contact your Miele dealer or Miele Customer Service.

You can book a Miele Customer Service call-out online at [www.miele.com/service](http://www.miele.com/service).

Contact information for Miele Customer Service can be found at the end of this document.

Please quote the model identifier and serial number of your appliance (SN) when contacting Miele Customer Service. Both numbers can be found on the data plate inside the refrigeration appliance or, depending on the model, in Settings mode under Information **i**.

## EPREL database

Since 1 March 2021, information on energy labelling and ecodesign requirements has been available in the European Product Database (EPREL). You can find the product database at the following link <https://eprel.ec.europa.eu/>. You will be asked to enter the model identifier.

The model identifier can be found on the data plate inside the refrigeration appliance or, depending on the model, in Settings mode under Information **i**.

**Miele**

XXXXXX ← Nr. XX/XXXXXXXXXX.

WEINTEMPERSCHRANK-UNTERTISCHMODELL  
MULTI-TEMP. REFRIG. WINE STORAGE CABINET UNDERCOUNTER TOP  
ARMOIRE DE LIÈGE EN TEMP. DES VIN(S) MOD. ENCASTRABLE SOUS PLAN  
ARMARIO P. ACONDICIONAM.TO. VINOS/MODEN.POTREBAJO ENCIMERA  
BRIKHAU-TEMPERATURKABINETT/UNTER

Klasse/Class Classe/Classe	Ap-Type/AP-Type AP-Type/AP-Tipo	Brutto/Netto/Gross Capacity Volume Bruto/Capacità Bruta	Gefrier-/Kühlraum/Freezing Capacity Pouvoir de Congel./Capac. Congeladora
SN-ST		XXX I	

<table border="0"> <tr> <td style="padding-right: 5px;">Nutzer/Netto</td> <td style="padding-right: 5px;">Ges / Tot</td> <td style="padding-right: 5px;">/K /R</td> <td style="padding-right: 5px;">/G /C</td> <td style="padding-right: 5px;">/WEIN /WINE</td> <td style="padding-right: 5px;">/KALT /CHILL</td> </tr> <tr> <td style="padding-right: 5px;">Capac. Util</td> <td style="padding-right: 5px;">Tot</td> <td style="padding-right: 5px;">/F /C</td> <td style="padding-right: 5px;">/VINO /CHILL</td> <td colspan="2"></td> </tr> </table>	Nutzer/Netto	Ges / Tot	/K /R	/G /C	/WEIN /WINE	/KALT /CHILL	Capac. Util	Tot	/F /C	/VINO /CHILL			<p><b>R600a: XXg</b></p>
Nutzer/Netto	Ges / Tot	/K /R	/G /C	/WEIN /WINE	/KALT /CHILL								
Capac. Util	Tot	/F /C	/VINO /CHILL										

## Warranty

For information on the appliance warranty specific to your country please contact Miele. See back cover for address.

In the UK, your appliance warranty is valid for 2 years from the date of purchase. However, you must activate your cover by calling 0330 160 6640 or registering online at [www.miele.co.uk](http://www.miele.co.uk).

# Information

---

## EU Conformity declaration

Miele hereby declares that this fridge-freezer complies with Directive 2014/53/EU. The complete text of the EU declaration of conformity is available from one of the following internet addresses:

- Products, Download from [www.miele.ie](http://www.miele.ie)
- For service, information, operating instructions etc: go to <https://miele.ie/manuals> and enter the name of the product or the serial number

Frequency range of the WiFi module	2.4000–2.4835 GHz
------------------------------------	-------------------

Maximum transmission power of the WiFi module	< 100 mW
---	----------

## UK Conformity declaration

Miele hereby declares that this fridge-freezer complies with UK Radio Equipment Regulations 2017, as amended.

The complete text of the UK declaration of conformity is available from one of the following internet addresses:

- Products, Download from [www.miele.co.uk](http://www.miele.co.uk)
- For service, information, operating instructions etc: go to <https://miele.co.uk/manuals> and enter the name of the product or the serial number

Frequency band of the WiFi module	2.4000 GHz – 2.4835 GHz
-----------------------------------	-------------------------

Maximum transmitting power of the WiFi module	< 100 mW
---	----------

This **Statement of Compliance** confirms this Miele product fully complies with the **Product Security and Telecommunications Infrastructure (Security Requirements for Relevant Connectable Products) Regulations 2023**.

- 1) Household Appliance – *Freezer - 120002, 120003, 220009, 320001, 320002*  
*Refrigerator - 110001, 110002, 210010, 310001, 310002, 310003*  
*Fridge-freezer - 130001, 130002, 130003, 130004, 330001, 330002, 330005*  
*Wine unit - 210007, 210011, 310004, 330004*
- 2) Manufactured by: Miele & Cie KG,  
Carl Miele Street 29, 33332 Gutersloh Germany  
Imported by and contact point: Miele Company Ltd, Fairacres, Marcham Road,  
Abingdon, Oxon, OX14 ITW Great Britain
- 3) The defined support period at the time of first supply is 10 years
- 4) To report vulnerabilities and cybersecurity issues please contact: psirt@miele.com
- 5) Signature   
Name: **Paul Wright**  
Company Position: **Head of Technical Management**  
Date of signature: **19th March 2024**  
Place of signature: **Abingdon, Oxfordshire**

## Copyrights and licences

For the purpose of operating and controlling the communication module, Miele uses proprietary or third-party software that is not covered by open source licensing terms. This software/these software components are protected by copyright. The copyrights held by Miele and third parties must be respected.

Furthermore, the communication module integrated in the appliance contains software components which are distributed under open source licence conditions. The open source components contained in the appliance along with the corresponding copyright notices, copies of the licensing terms valid at the time and any further information can be accessed locally by IP via a web browser ([http\[s\]://<IP address>/Licenses](http[s]://<IP address>/Licenses)). The liability and warranty arrangements for the open source licences displayed in this location only apply in relation to the respective rights holders.







## United Kingdom

Miele Co. Ltd., Fairacres, Marcham Road, Abingdon, Oxon, OX14 1TW  
Tel: 0330 160 6600, Internet: [www.miele.co.uk](http://www.miele.co.uk), E-mail: [info@miele.co.uk](mailto:info@miele.co.uk)

### Australia

Miele Australia Pty. Ltd.  
ACN 005 635 398  
ABN 96 005 635 398  
Level 4, 141 Camberwell Road  
Hawthorn East, VIC 3123  
Tel: 1300 464 353  
E-mail: [info@miele.com.au](mailto:info@miele.com.au)  
Internet: [www.miele.com.au](http://www.miele.com.au)

### China Mainland

Miele Electrical Appliances Co. Ltd.  
No. 82, Shimenyi Road, JingAn District  
Shanghai, China, P.R.C  
Post Code: 200040  
Phone: +86 21 6157 3500  
Fax: +86 21 6157 3511  
E-mail: [info@miele.cn](mailto:info@miele.cn)  
Internet: [www.miele.cn](http://www.miele.cn)

### Hong Kong, China

Miele (Hong Kong) Ltd.  
41/F - 4101, Manhattan Place  
23 Wang Tai Road  
Kowloon Bay, Hong Kong  
Tel: (852) 2610 1025  
Fax: (852) 3579 1404  
E-mail:  
[customerservices@miele.com.hk](mailto:customerservices@miele.com.hk)  
Website: [www.miele.hk](http://www.miele.hk)

### India

Miele India Pvt. Ltd.  
1st Floor, Copia Corporate Suites,  
Commercial Plot 9, Mathura Road,  
Jasola, New Delhi - 110025  
E-mail: [customercare@miele.in](mailto:customercare@miele.in)  
Website: [www.miele.in](http://www.miele.in)

### Ireland

Miele Ireland Ltd.  
2024 Bianconi Avenue  
Citywest Business Campus  
Dublin 24  
Tel: (01) 461 07 10  
Tel: (01) 461 07 97  
Fax: (01) 461 07 97  
E-mail: [info@miele.ie](mailto:info@miele.ie)  
Internet: [www.miele.ie](http://www.miele.ie)

### Malaysia

Miele Sdn Bhd  
Suite 12-2, Level 12  
Menara Sapura Kencana  
Petroleum  
Solaris Dutamas No. 1  
Jalan Dutamas 1  
50480 Kuala Lumpur, Malaysia  
Phone: +603-6209-0288  
Fax: +603-6205-3768

### New Zealand

Miele New Zealand Limited  
IRD 98 463 631  
8 College Hill  
Freemans Bay, Auckland 1011  
Tel: 0800 464 353  
E-mail: [customercare@miele.co.nz](mailto:customercare@miele.co.nz)  
Internet: [www.miele.co.nz](http://www.miele.co.nz)

### Singapore

Miele Pte. Ltd.  
29 Media Circle  
#11-04 ALICE@Mediapolis  
Singapore 138565  
Tel: +65 6735 1191  
Fax: +65 6735 1161  
E-mail: [info@miele.com.sg](mailto:info@miele.com.sg)  
Internet: [www.miele.sg](http://www.miele.sg)

### South Africa

Miele (Pty) Ltd.  
63 Peter Place, Bryanston 2194  
P.O. Box 69434, Bryanston 2021  
Tel: (011) 875 9000  
Fax: (011) 875 9035  
E-mail: [info@miele.co.za](mailto:info@miele.co.za)  
Internet: [www.miele.co.za](http://www.miele.co.za)

### Thailand

Miele Appliances Ltd.  
BHIRAJ TOWER at EmQuartier  
43rd Floor Unit 4301-4303  
689 Sukhumvit Road  
North Klongton Sub-District  
Vadhana District  
Bangkok 10110, Thailand

### United Arab Emirates

Miele Appliances Ltd.  
Showroom 1, Eiffel 1 Building  
Sheikh Zayed Road, Umm Al Sheif  
P.O. Box 114782 - Dubai  
Tel. +971 4 3044 999  
Fax. +971 4 3418 852  
800-MIELE (64353)  
E-mail: [info@miele.ae](mailto:info@miele.ae)  
Website: [www.miele.ae](http://www.miele.ae)

**Manufacturer:** Miele & Cie. KG, Carl-Miele-Straße 29, 33332 Gütersloh, Germany

KFFD 6741 ...

en-GB

M.-Nr. 13 029 800 / 01 / 002