

# **VEVOR<sup>®</sup>**

**TOUGH TOOLS, HALF PRICE**

Technical Support and E-Warranty Certificate

[www.vevor.com/support](http://www.vevor.com/support)

## **ELECTRONIC DRUM SET USER MANUAL**

**MODEL: MD200F-P**

We continue to be committed to provide you tools with competitive price. "Save Half", "Half Price" or any other similar expressions used by us only represents an estimate of savings you might benefit from buying certain tools with us compared to the major top brands and does not necessarily mean to cover all categories of tools offered by us. You are kindly reminded to verify carefully when you are placing an order with us if you are actually Saving Half in comparison with the top major brands.

# VEVOR<sup>®</sup>

TOUGH TOOLS, HALF PRICE

## ELECTRONIC DRUM SET

**MODEL: MD200F-P**

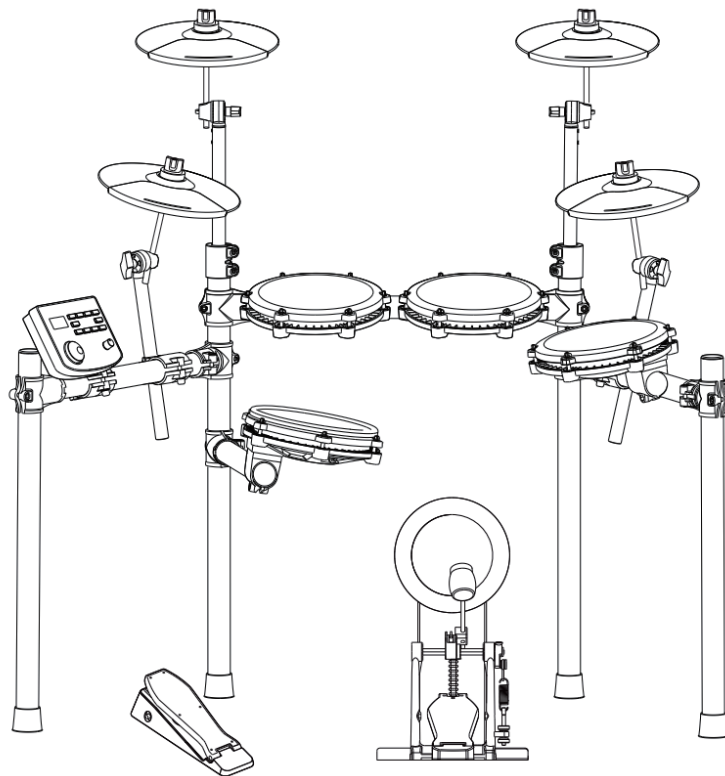

(The picture is for reference only, please refer to the actual object)

### **NEED HELP? CONTACT US!**

Have product questions? Need technical support? Please feel free to contact us:

**Technical Support and E-Warranty Certificate**  
**[www.vevor.com/support](http://www.vevor.com/support)**

This is the original instruction, please read all manual instructions carefully before operating. VEVOR reserves a clear interpretation of our user manual. The appearance of the product shall be subject to the product you received. Please forgive us that we won't inform you again if there are any technology or software updates on our product.



## FUNCTION INTRODUCTION

Thank you for choosing our electronic drum. Elegant and delicate electronic drum is the perfect combination of modern new electronic technology.

◆Before using this product, you must read the instructions in detail.

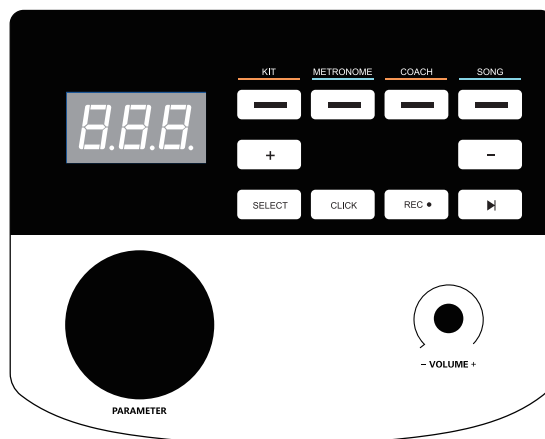

- 32 sets of drums, 480 timbres
- 30 songs
- Support the adjustment of sensitivity parameters of each drum
- Three teaching modes
- Speed control: 30 ~ 250 beats / min
- Metronome: 1-9 types
- Other functions: parameter storage, reset and recording;
- three digit led display;
- interface: power supply dc, usbmidi, earphone, audio input, audio output

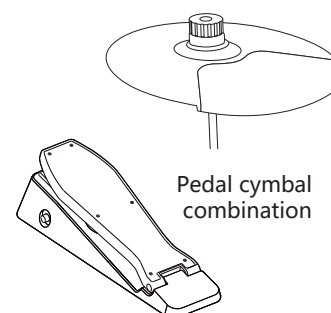
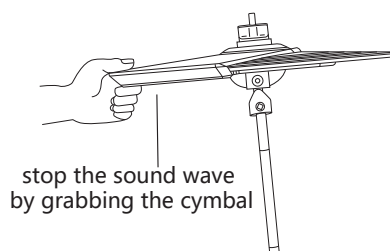
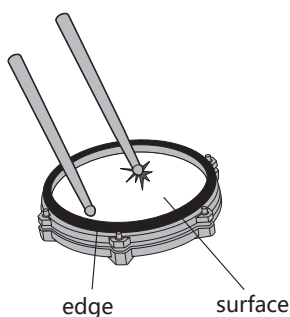

### REMARK!

- This product is an electro-acoustic instrument product. It is normal that there is a little current sound in the speaker or earphone after power-on.  
Keep away from "radio, TV, antenna receiver, router, refrigerator, TV, motor and other RF electrical interference sources" during using.



# CONTENTS

<b>FUNCTION INTRODUCTION</b>	<b>1</b>
<b>CONTENTS</b>	<b>2</b>
<b>INSTALLATION GUIDE</b>	<b>3</b>
CHECK THE ATTACHED ITEMS	3
LRON PIPE HOLDER	4
TYMPANIC INTUBATION	4
MOUNTING STAND	5
INSTALL THE DRUM MODULE	5
INSTALL HITTING PARTS AND SOUND MODULE	6
INSTALL THE KICK DRUM	7
INSTALL THE HAMMER BAR	7
THE KICK DRUM IS FIXED WITH THE STEP HAMMER	7
PLUG IN THE STRIKING PART CONNECTION CABLE	7
<b>ILLUSTRATION OF SOUND MODULE PORT</b>	<b>8</b>
POWER CORD CONNECTION	8
USB MIDI PORT	8
AUDIO OUTPUT PORT	8
AUDIO INPUT PORT	8
EARPHONE PORT	8
INCREASE PORT	8
BT MODE	8
<b>OPERATION GUIDE</b>	<b>9</b>
POWER	9
DRUM KIT SELECTION	9
METRONOME	9
PRACTICE FUNCTION	9
COACH MODE	9
DEMO SONGS	10
DRUM PARAMETERS	10
RECORDING FUNCTION	10
SAVE / RESET	10
USB MIDI	11
<b>APPENDIX</b>	<b>11</b>
TIMBRE	11
PRESET DRUM KITS	11
USER DEFINED DRUM KITS	11
DEMO STRATION SONG	11
<b>PRODUCT MAINTENANCE</b>	<b>12</b>
<b>SAFETY PRECAUTIONS</b>	<b>13</b>



# INSTALLATION GUIDE

## REMARK!

- Please follow the instructions and read the "safety precautions" in the User Manual carefully before using.
- This product must be installed by adult, please do not let the minor install it independently.

# 01

## Check the attached items

- After opening the package, please check whether it contains all the items immediately. If there are any omissions, please contact your dealer.

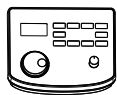

Sound module



Module bracket



Cymbal \*4

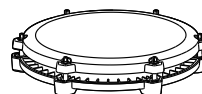

Tom (3pcs)

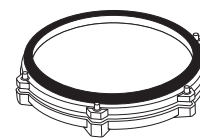

Snare

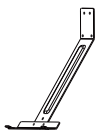

Rear support



Connecting bracket



Front bracket



Kick

2PCS 2PCS 6PCS



screw

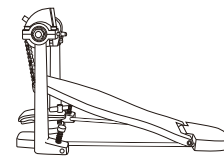

Kick pedal



Cymbal arm  
(4pcs)

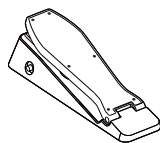

Hi hat pedal



Bolt driver

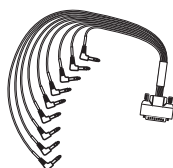

Signal Connection cable

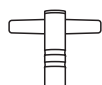

Drum key



Power adapter



Drum stick



Stick hammer



# ASSEMBLY DRAWING

## 02

### Iron pipe holder

•The stand is located in a small individual package inside the box.

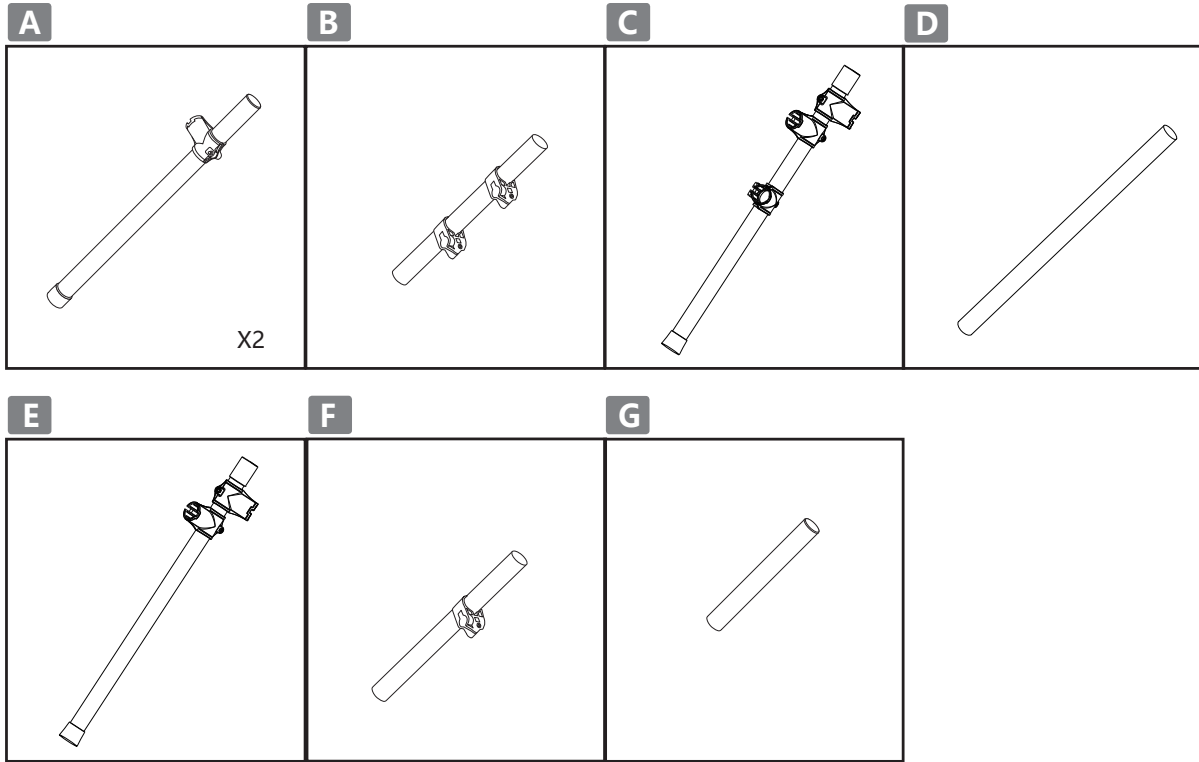

## 03

### Tympanic intubation

Install the drum on the drum support bar.

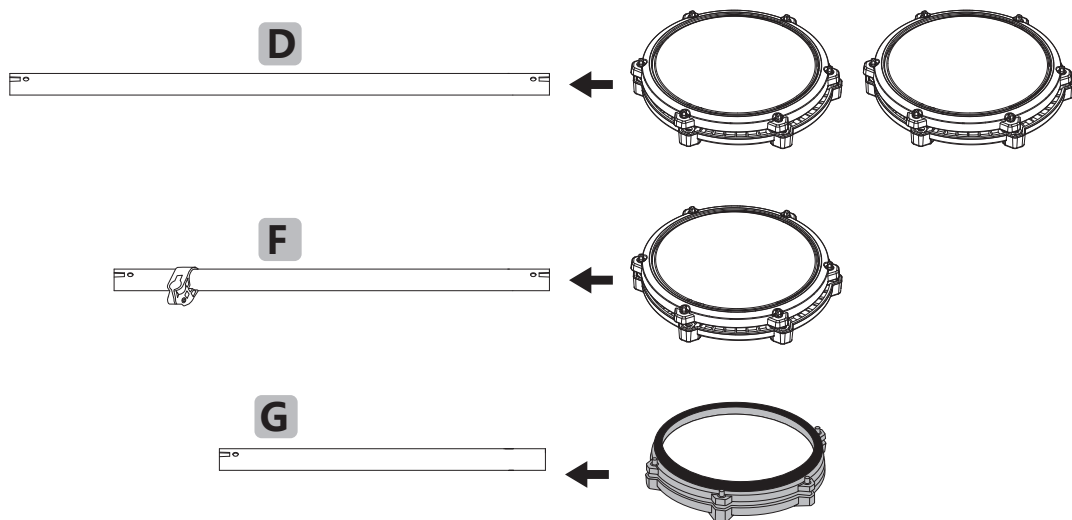



## 04

### Mounting stand

- During the installation, tighten the screws and please be careful to pinch your fingers.
- Assemble the bracket as the specified direction

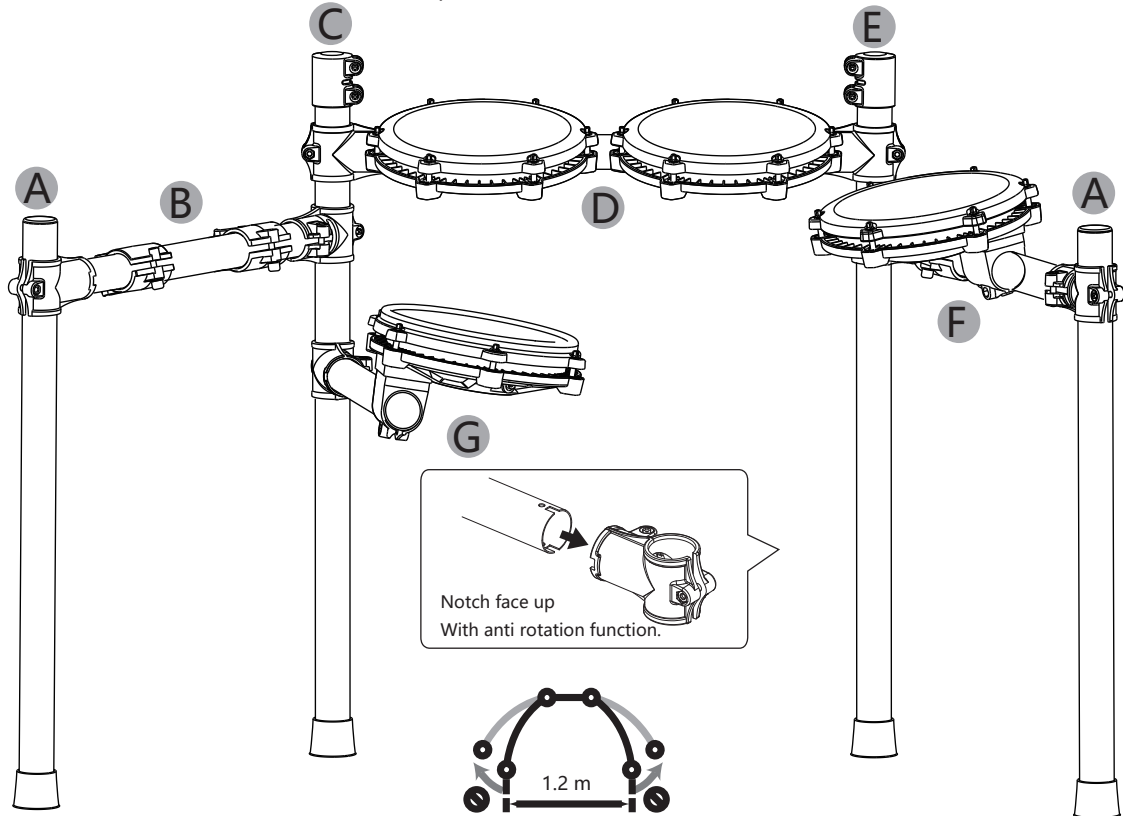

For safety reasons, the expansion width of the support should not be greater than 1.2 meters.

## 05

### Install the Drum module

- Please insert it in place during installing.

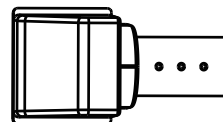
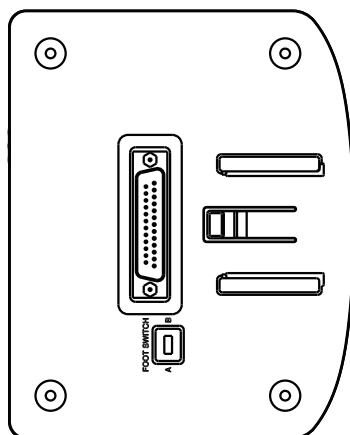

Align the mainframe drum module with the mainframe box track and insert it. After inserting it to the bottom, you can hear the snap pieces pop up.



## 06

### Install hitting parts and sound module

- Tighten the screws after the drum is inserted to avoid loosening.
- Be sure not to tighten the cymbal too tightly, leave some space for them to snake up and down.

Withdraw the nuts and circle cushions of the three cymbal arm, put the three cymbals into the corresponding arm, and screw on the nuts. Put 3 drums and 1 drum into the corresponding support rod respectively, and tighten the screws. Note: the functions of each cymbal, Tom drum and snare drum are different, so it is necessary to refer to the accessory identification for correct installation!

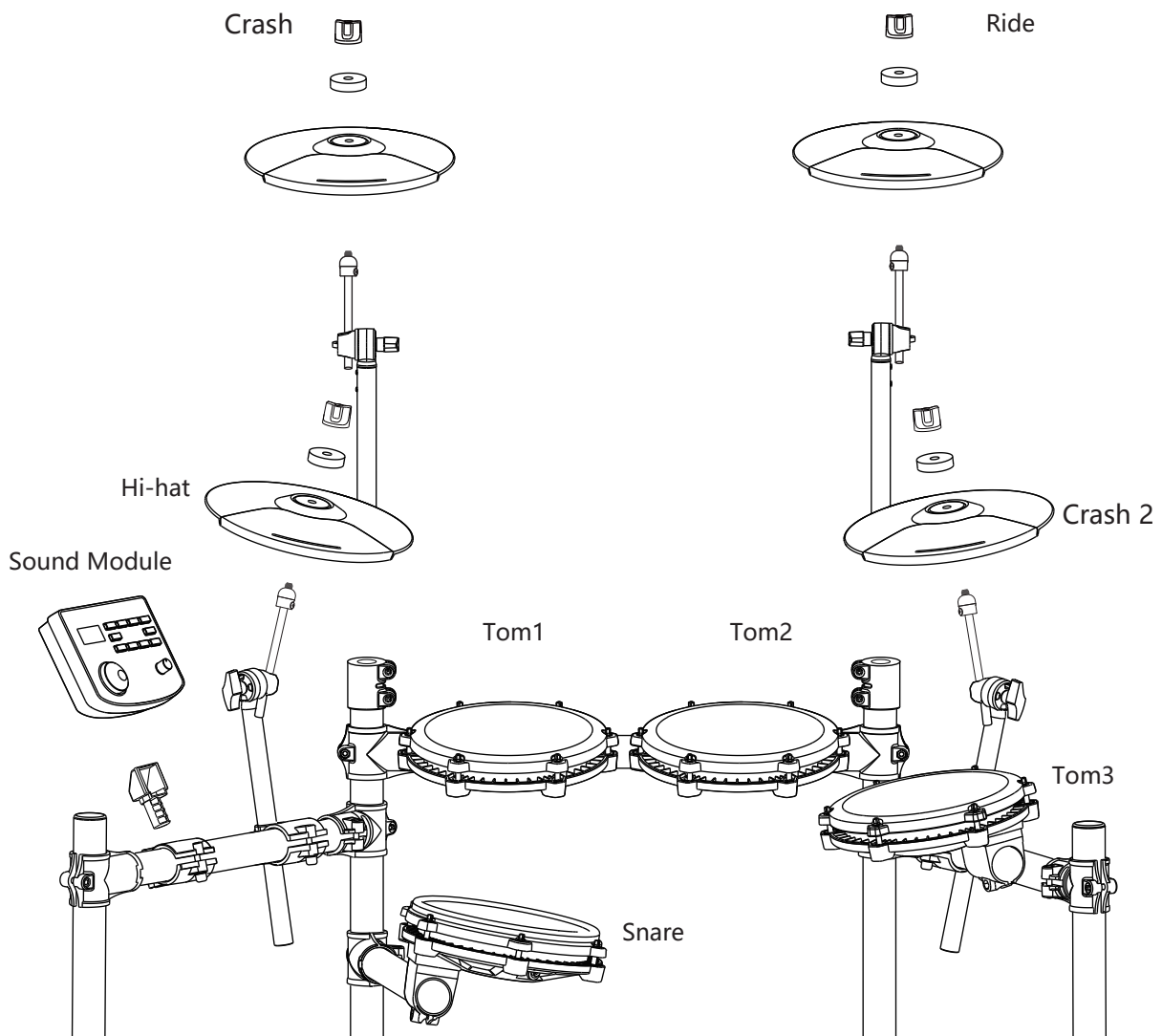



# INSTALLATION GUIDE

## 07

### Install the kick drum

- when installing, please tighten the screws and be careful not to pinch your fingers.

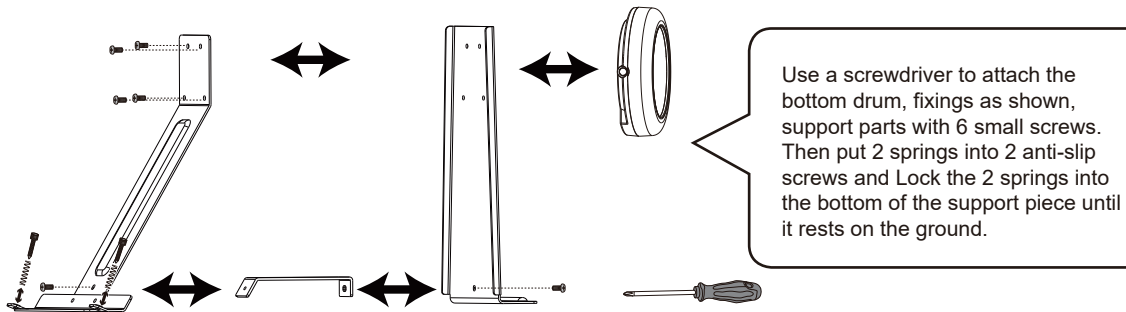

## 08

### Install the hammer bar

- the pole should be inserted in lace and the screws should be tightened to avoid loosening.

Insert the hammer rod into the round hole as shown in the figure, rotate the wool hammer to align it with the drum surface, and then tighten it with the drum key.

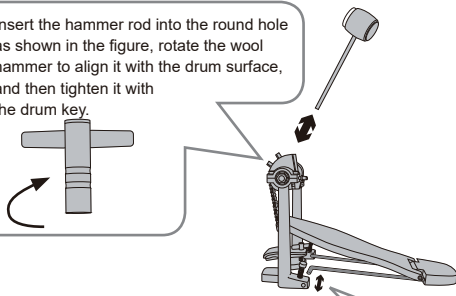

Insert the fixed iron bar into the hole as shown in the figure.

## 09

### The kick drum is fixed with the step hammer

- the bottom drum and the step hammer should be fixed and tightened to avoid falling off.

Insert the protruding edge of the low drum into the hammer fixing clip as shown in the figure, and tighten the screws.

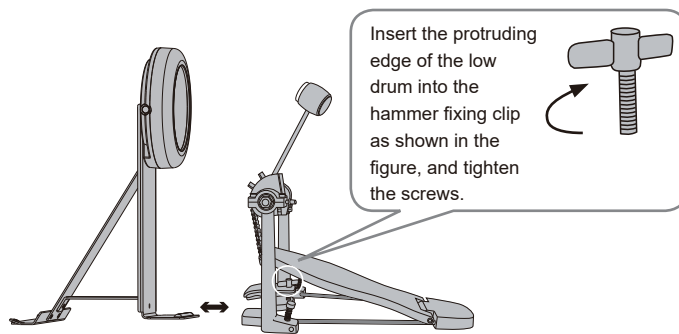

## 10

### Plug in the striking part connection cable

- Please insert the connection cable in place to avoid poor contact and insert it correctly as shown in the diagram.

Please check whether the bottom drum makes sound, If there is no sound, please turn the switch:  
Switch in A: mechanical kick drum mode  
Switch in B: pedal mode.

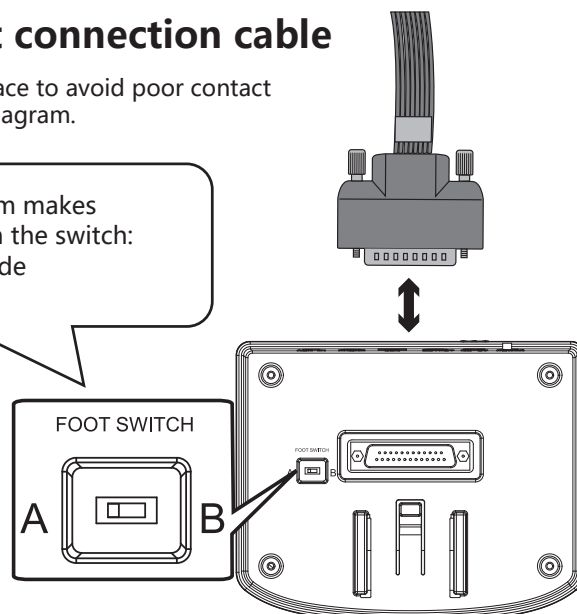



## ILLUSTRATION OF SOUND MODULE PORT

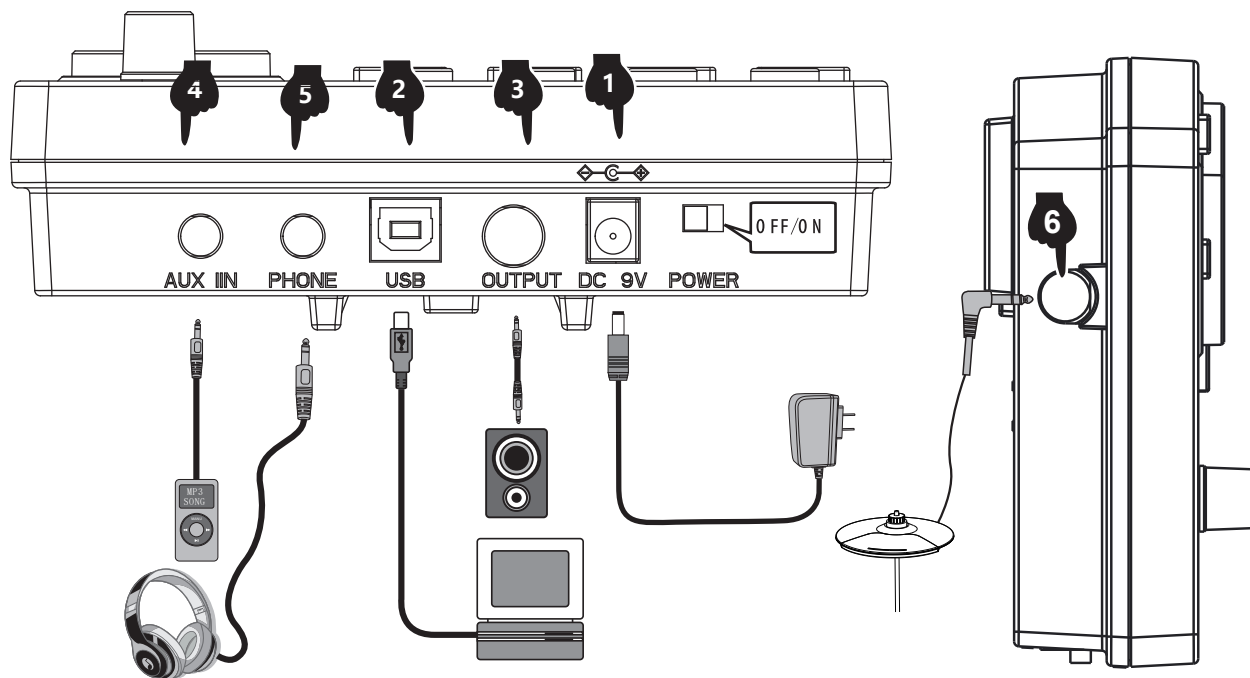

### 1 POWER CORD CONNECTION

1. When in use, connect the power terminal according to the diagram, insert the power outlet of the sound module at one end and 100-240V household power outlet at the other end. (Fig. 1)
2. If you do not use this product for a long time, please pull out the power plug and keep it properly.

### 2 USB MIDI PORT

The use of electronic drum MIDI USB interface can interact with music devices with MIDI.

1. Through the pre-installed Music software on computers and mobile phones, we can learn to play, compose music, store and other functions. (Fig. 2)
2. When connected to a computer or mobile phone, the audio output of the device needs to be connected to the audio input socket of the module box in order to synchronize the sound effects on the device. (Fig. 5)

### 3 AUDIO OUTPUT PORT

Audio output port can be connected with active speaker (special electronic drum speaker) and large audio equipment. (Fig. 3)

### 4 AUDIO INPUT PORT

Audio input port can connect the sound source playback device to the module box for playback (such as MP3, mobile phone and other audio signal input). (Fig. 4)

### 5 EARPHONE PORT

Connecting headphones monitors the details of percussion and does not disturb others when playing without connecting speakers. (Fig. 5)

### 6 INCREASE PORT

This port allows you to add a cymbal for easy expansion. (Figure 6)



# OPERATION GUIDE

## 1 POWER

Insert the DC plug into the DC 9V port on the top of the control unit. Slide the POWER switch to the right (viewed from the front) to power up the drum kit. To turn the drum kit off slide the switch to the left.

## 2 DRUM KIT SELECTION

Press the KIT button to show the current drum kit. Turn the parameter wheel or use the <- /+> buttons to select the desired drum kit. There are 32 drum kits to choose from - see drum kit list on page 11.

## 3 METRONOME

1. Press the METRONOME button to enter the metronome mode.
2. The screen will display the speed value (120 BPM default speed). Turn the parameter wheel or use the +/- buttons to change the metronome speed. Press the CLICK button to start the metronome.
3. Press the SELECT button in metronome mode, and the screen will jump to the metronome parameter adjustment interface. You can press the +/- buttons to select the parameter you want to adjust:
  - A. r (beat type: 2, 4, 8, 16)
  - B. b (beat number: 01-09)
  - C. L (metronome volume: 00 (off) -31), and then turn the parameter wheel to adjust the parameter settings.
4. Once the parameters have been adjusted, press the SELECT button to confirm and exit the parameter interface. Then use the CLICK button to start and stop the metronome as desired.

## 4 PRACTICE FUNCTION

The "coach" coach mode of this product can help establish speed, accuracy and endurance, and help cultivate the practice function of a better sense of rhythm. Make progress under the supervision of the "coach" coach mode! Press the "coach" button to enter the coach mode. In this mode, there are three practice modes. Select the practice mode through the data wheel or <+> <-> button.

1. Exercise mode 1: C-1 beat detection exercise: beat the drum at a fixed speed to train the accuracy of the blow.
2. Practice mode 2: C-2 silent strike mode: the metronome will sound one section and mute one section to train the strike accuracy without metronome prompt. It is an advanced version of practice mode 1.
3. Practice mode 3: C-3 speed strike practice, the metronome will automatically change the speed, increase from the slowest express to the fastest, and then reduce from the slowest express to the slowest speed, so as to practice the strike endurance.

## 5 COACH MODE

1. The "coach" training mode of this product can help establish speed, accuracy and endurance. Press the COACH button to enter the coach mode. In this mode, there are three practice modes. Use the parameter wheel to select which practice mode.
  - A. Exercise mode 1: C-1 beat detection exercise- beat the drum at a fixed speed to train the accuracy of the blow.
  - B. Practice mode 2: C-2 silent strike mode-the metronome will sound one section and mute one section to train when there is no beat.
  - C. Practice mode 3: C-3 speed strike practice-the metronome will automatically change the speed from the slowest to the fastest and then the fastest to the slowest.
2. Once the coaching mode has been chosen, press the CLICK button. The metronome beats will start and you can play along on the drum for practice.
3. After four preliminary beats, the display will show:

(too slow)



(good)



(too fast)





## OPERATION GUIDE

4. Once you have completed the coaching mode a score will be displayed from 0-100 evaluating the accuracy of the exercise.

C-1 mode: Press the SELECT button to enter the parameter setting interface. You can adjust the number of practice sessions as required (01-32). The number of sessions to practice determines the length of this exercise.

C-2 mode: Press the SELECT button to enter the parameter setting interface. You can adjust the number of practice sessions as required (04-32). The number of sessions to practice determines the length of this exercise.

C-3 mode: Press the SELECT button to enter the parameter setting interface. You can adjust the rate at which the BPM changes (01-09 BPM).

5. Press the CLICK button again to end the coach mode.

### 6 DEMO SONGS

1. Press the SONG button to enter the demo mode, there are 30 demos to choose from. The screen will display the current demo song number (01 -30).
2. Press the <▶|> button to start playing the demo songs. To stop playing press the <▶|> button again.
3. Turn the parameter wheel or press the +/- buttons to select a demo song.
4. Press the SELECT button in song mode to jump to the song parameter setting interface. You can turn the drum sound on or off by turning the parameter wheel (the drum sound is on by default).
5. Press the SELECT button to confirm and exit the parameter interface.

### 7 DRUM PARAMETERS

1. Press the KIT button and the screen will display 01 (drum kit number). Press SELECT to enter the drum parameter adjustment mode.
2. Tap the drum you want to adjust, and then press the +/- buttons to select the parameter for adjustment. Sensitivity  
A. S(01-06). Trigger threshold t(01 - 32). Crosstalk threshold c (01 -32)  
B. Repeated trigger r(01-32) Drum Force V(01-03). Drum volume L (00 - 31).
3. Change the parameters by rotating the parameter wheel and long press the - button to save. The screen will display SAV to indicate the parameter adjustment has been saved successfully.
4. To restore the drum parameters back to factory settings long press the + button until the screen displays RES.
5. PLEASE NOTE: The parameters for the 3 tom drums can not be set individually.

### 8 RECORDING FUNCTION

1. Press the < REC > button when the indicator light is in the "KIT" and "CLICK" states, and the screen displays the words "REC" in the breathing flashing state, entering the recording preparation state.
2. Tap any drum and the metronome sounds. At this time, the screen displays "---" in the flashing state of breathing and starts recording.
3. Press the < REC > key or < PLAY > key again, the recording stops and "A-1" is displayed on the screen.
4. Press < ▶| > to start playing the current recording, and press again to stop playback.
5. If you enter the recording preparation state again without any knocking, the "A-1" recorded last time is played back.

### 9 SAVE / RESET

1. To save parameters long press the <-> button and the screen will display SAV.
2. To reset parameters long press the <+> button and the screen will display RES res.

### 10 USB MIDI

To use the drum kits MID function plug a USB-B data cable (not included with this drum kit) into the control unit and connect to PC/Smartphone.



# APPENDIX

## Timbre

### Kick .

- 1 . Pop Kick
- 2 . Fuck Kick
- 3 . Hard Kick
- 4 . Original Kick
- 5 . PopRock Kick
- 6 . Rock Kick
- 7 . Metal Kick
- 8 . PowerMetal Kick
- 9 . SpeedMetal Kick
- 10 . PopJazz Kick
- 11 . Jazz Kick
- 12 . 808
- 13 . 909
- 14 . Songo Kick
- 15 . Standard Kick
- 16 . Acoustic Kick
- 17 . Seesion Kick
- 18 . Modern Kick
- 19 . Blues Kick
- 20 . Classic Kick
- 21 . Synthgaze Kick
- 22 . Freak Kick
- 23 . Sticks Kick
- 24 . Grunge Kick
- 25 . 70's Kick
- 26 . 80's Kick
- 27 . Popular Kick
- 28 . Slam Kick
- 29 . Attack Kick
- 30 . Old Kick
- 31 . Fairfax Kick
- 32 . Military Kick

### Snare .

- 33 . Pop Snare
- 34 . Fuck Snare
- 35 . Hard Snare
- 36 . Original Snare
- 37 . PopRock Snare
- 38 . Rock Snare
- 39 . Metal Snare
- 40 . PowerMetal Snare
- 41 . SpeedMetal Snare
- 42 . PopJazz Snare
- 43 . Jazz Snare
- 44 . 808
- 45 . 909
- 46 . Songo Snare
- 47 . Standard Snare
- 48 . Acoustic Snare
- 49 . Seesion Snare
- 50 . Modern Snare
- 51 . Blues Snare
- 52 . Classic Snare
- 53 . Synthgaze Snare
- 54 . Freak Snare
- 55 . Sticks Snare
- 56 . Grunge Snare
- 57 . 70's Snare
- 58 . 80's Snare
- 59 . Popular Snare
- 60 . Slam Snare
- 61 . Attack Snare
- 62 . Old Snare
- 63 . Fairfax Snare
- 64 . Military Snare
- 65 . Pop Snare Rim
- 66 . Fuck Snare Rim
- 67 . Hard Snare Rim
- 68 . Original Snare Rim
- 69 . PopRock Snare Rim

- 70 . Rock Snare Rim
- 71 . Metal Snare Rim
- 72 . PowerMetal Snare Rim
- 73 . SpeedMetal Snare Rim
- 74 . PopJazz Snare Rim
- 75 . Jazz Snare Rim
- 76 . 808
- 77 . 909
- 78 . Songo Snare Rim
- 79 . Standard Snare Rim
- 80 . Acoustic Snare Rim
- 81 . Seesion Snare Rim
- 82 . Modern Snare Rim
- 83 . Blues Snare Rim
- 84 . Classic Snare Rim
- 85 . Synthgaze Snare Rim
- 86 . Freak Snare Rim
- 87 . Sticks Snare Rim
- 88 . Grunge Snare Rim
- 89 . 70's Snare Rim
- 90 . 80's Snare Rim
- 91 . Popular Snare Rim
- 92 . Slam Snare Rim
- 93 . Attack Snare Rim
- 94 . Old Snare Rim
- 95 . Fairfax Snare Rim
- 96 . Military Snare Rim

### Tom .

- 97 . Pop Tom1
- 98 . Fuck Tom1
- 99 . Hard Tom1
- 100 . Original Tom1
- 101 . PopRock Tom1
- 102 . Rock Tom1
- 103 . Metal Tom1
- 104 . PowerMetal Tom1
- 105 . SpeedMetal Tom1
- 106 . PopJazz Tom1
- 107 . Jazz Tom1
- 108 . 808
- 109 . 909
- 110 . Songo Tom1
- 111 . Standard Tom1
- 112 . Acoustic Tom1
- 113 . Seesion Tom1
- 114 . Modern Tom1
- 115 . Blues Tom1
- 116 . Classic Tom1
- 117 . Synthgaze Tom1
- 118 . Freak Tom1
- 119 . Sticks Tom1
- 120 . Grunge Tom1
- 121 . 70's Tom1
- 122 . 80's Tom1
- 123 . Popular Tom1
- 124 . Slam Tom1
- 125 . Attack Tom1
- 126 . Old Tom1
- 127 . Fairfax Tom1
- 128 . Military Tom1
- 129 . Pop Tom2
- 130 . Fuck Tom2
- 131 . Hard Tom2
- 132 . Original Tom2
- 133 . PopRock Tom2

- 134 . Rock Tom2
- 135 . Metal Tom2
- 136 . PowerMetal Tom2
- 137 . SpeedMetal Tom2
- 138 . PopJazz Tom2
- 139 . Jazz Tom2
- 140 . 808
- 141 . 909
- 142 . Songo Tom2
- 143 . Standard Tom2
- 144 . Acoustic Tom2
- 145 . Seesion Tom2
- 146 . Modern Tom2
- 147 . Blues Tom2
- 148 . Classic Tom2
- 149 . Synthgaze Tom2
- 150 . Freak Tom2
- 151 . Sticks Tom2
- 152 . Grunge Tom2
- 153 . 70's Tom2
- 154 . 80's Tom2
- 155 . Popular Tom2
- 156 . Slam Tom2
- 157 . Attack Tom2
- 158 . Old Tom2
- 159 . Fairfax Tom2
- 160 . Military Tom2
- 161 . Pop Tom3
- 162 . Fuck Tom3
- 163 . Hard Tom3
- 164 . Original Tom3
- 165 . PopRock Tom3
- 166 . Rock Tom3
- 167 . Metal Tom3
- 168 . PowerMetal Tom3
- 169 . SpeedMetal Tom3
- 170 . PopJazz Tom3
- 171 . Jazz Tom3
- 172 . 808
- 173 . 909
- 174 . Songo Tom3
- 175 . Standard Tom3
- 176 . Acoustic Tom3
- 177 . Seesion Tom3
- 178 . Modern Tom3
- 179 . Blues Tom3
- 180 . Classic Tom3
- 181 . Synthgaze Tom3
- 182 . Freak Tom3
- 183 . Sticks Tom3
- 184 . Grunge Tom3
- 185 . 70's Tom3
- 186 . 80's Tom3
- 187 . Popular Tom3
- 188 . Slam Tom3
- 189 . Attack Tom3
- 190 . Old Tom3
- 191 . Fairfax Tom3
- 192 . Military Tom3

### Crash .

- 193 . Pop Crash1
- 194 . Fuck Crash1
- 195 . Hard Crash1
- 196 . Original Crash1
- 197 . PopRock Crash1

- 198 . Rock Crash1
- 199 . Metal Crash1
- 200 . PowerMetal Crash1
- 201 . SpeedMetal Crash1
- 202 . PopJazz Crash1
- 203 . Jazz Crash1
- 204 . 808
- 205 . 909
- 206 . Songo Crash1
- 207 . Standard Crash1
- 208 . Acoustic Crash1
- 209 . Seesion Crash1
- 210 . Modern Crash1
- 211 . Blues Crash1
- 212 . Classic Crash1
- 213 . Synthgaze Crash1
- 214 . Freak Crash1
- 215 . Sticks Crash1
- 216 . Grunge Crash1
- 217 . 70's Crash1
- 218 . 80's Crash1
- 219 . Popular Crash1
- 220 . Slam Crash1
- 221 . Attack Crash1
- 222 . Old Crash1
- 223 . Fairfax Crash1
- 224 . Military Crash1
- 225 . Pop Crash1 Rim
- 226 . Fuck Crash1 Rim
- 227 . Hard Crash1 Rim
- 228 . Original Crash1 Rim
- 229 . PopRock Crash1 Rim
- 230 . Rock Crash1 Rim
- 231 . Metal Crash1 Rim
- 232 . PowerMetal Crash1 Rim
- 233 . SpeedMetal Crash1 Rim
- 234 . PopJazz Crash1 Rim
- 235 . Jazz Crash1 Rim
- 236 . 808
- 237 . 909
- 238 . Songo Crash1 Rim
- 239 . Standard Crash1 Rim
- 240 . Acoustic Crash1 Rim
- 241 . Seesion Crash1 Rim
- 242 . Modern Crash1 Rim
- 243 . Blues Crash1 Rim
- 244 . Classic Crash1 Rim
- 245 . Synthgaze Crash1 Rim
- 246 . Freak Crash1 Rim
- 247 . Sticks Crash1 Rim
- 248 . Grunge Crash1 Rim
- 249 . 70's Crash1 Rim
- 250 . 80's Crash1 Rim
- 251 . Popular Crash1 Rim
- 252 . Slam Crash1 Rim
- 253 . Attack Crash1 Rim
- 254 . Old Crash1 Rim
- 255 . Fairfax Crash1 Rim
- 256 . Military Crash1 Rim

### Ride .

- 257 . Pop Ride
- 258 . Fuck Ride
- 259 . Hard Ride
- 260 . Original Ride
- 261 . PopRock Ride

- 262 . Rock Ride
- 263 . Metal Ride
- 264 . PowerMetal Ride
- 265 . SpeedMetal Ride
- 266 . PopJazz Ride
- 267 . Jazz Ride
- 268 . 808
- 269 . 909
- 270 . Songo Ride
- 271 . Standard Ride
- 272 . Acoustic Ride
- 273 . Seesion Ride
- 274 . Modern Ride
- 275 . Blues Ride
- 276 . Classic Ride
- 277 . Synthgaze Ride
- 278 . Freak Ride
- 279 . Sticks Ride
- 280 . Grunge Ride
- 281 . 70's Ride
- 282 . 80's Ride
- 283 . Popular Ride
- 284 . Slam Ride
- 285 . Attack Ride
- 286 . Old Ride
- 287 . Fairfax Ride
- 288 . Military Ride
- 289 . Pop Ride Rim
- 290 . Fuck Ride Rim
- 291 . Hard Ride Rim
- 292 . Original Ride Rim
- 293 . PopRock Ride Rim
- 294 . Rock Ride Rim
- 295 . Metal Ride Rim
- 296 . PowerMetal Ride Rim
- 297 . SpeedMetal Ride Rim
- 298 . PopJazz Ride Rim
- 299 . Jazz Ride Rim
- 300 . 808
- 301 . 909
- 302 . Songo Ride Rim
- 303 . Standard Ride Rim
- 304 . Acoustic Ride Rim
- 305 . Seesion Ride Rim
- 306 . Modern Ride Rim
- 307 . Blues Ride Rim
- 308 . Classic Ride Rim
- 309 . Synthgaze Ride Rim
- 310 . Freak Ride Rim
- 311 . Sticks Ride Rim
- 312 . Grunge Ride Rim
- 313 . 70's Ride Rim
- 314 . 80's Ride Rim
- 315 . Popular Ride Rim
- 316 . Slam Ride Rim
- 317 . Attack Ride Rim
- 318 . Old Ride Rim
- 319 . Fairfax Ride Rim
- 320 . Military Ride Rim

### Hi-Hat .

- 321 . Pop Hi-Hat Open
- 322 . Fuck Hi-Hat Open
- 323 . Hard Hi-Hat Open
- 324 . Original Hi-Hat Open
- 325 . PopRock Hi-Hat Open

- 326 . Rock Hi-Hat Open
- 327 . Metal Hi-Hat Open
- 328 . PowerMetal Hi-Hat Open
- 329 . SpeedMetal Hi-Hat Open
- 330 . PopJazz Hi-Hat Open
- 331 . Jazz Hi-Hat Open
- 332 . 808
- 333 . 909
- 334 . Songo Hi-Hat Open
- 335 . Standard Hi-Hat Open
- 336 . Acoustic Hi-Hat Open
- 337 . Seesion Hi-Hat Open
- 338 . Modern Hi-Hat Open
- 339 . Blues Hi-Hat Open
- 340 . Classic Hi-Hat Open
- 341 . Synthgaze Hi-Hat Open
- 342 . Freak Hi-Hat Open
- 343 . Sticks Hi-Hat Open
- 344 . Grunge Hi-Hat Open
- 345 . 70's Hi-Hat Open
- 346 . 80's Hi-Hat Open
- 347 . Popular Hi-Hat Open
- 348 . Slam Hi-Hat Open
- 349 . Attack Hi-Hat Open
- 350 . Old Hi-Hat Open
- 351 . Fairfax Hi-Hat Open
- 352 . Military Hi-Hat Open
- 353 . Pop Hi-Hat Close
- 354 . Fuck Hi-Hat Close
- 355 . Hard Hi-Hat Close
- 356 . Original Hi-Hat Close
- 357 . PopRock Hi-Hat Close
- 358 . Rock Hi-Hat Close
- 359 . Metal Hi-Hat Close
- 360 . PowerMetal Hi-Hat Close
- 361 . SpeedMetal Hi-Hat Close
- 362 . PopJazz Hi-Hat Close
- 363 . Jazz Hi-Hat Close
- 364 . 808
- 365 . 909
- 366 . Songo Hi-Hat Close
- 367 . Standard Hi-Hat Close
- 368 . Acoustic Hi-Hat Close
- 369 . Seesion Hi-Hat Close
- 370 . Modern Hi-Hat Close
- 371 . Blues Hi-Hat Close
- 372 . Classic Hi-Hat Close
- 373 . Synthgaze Hi-Hat Close
- 374 . Freak Hi-Hat Close
- 375 . Sticks Hi-Hat Close
- 376 . Grunge Hi-Hat Close
- 377 . 70's Hi-Hat Close
- 378 . 80's Hi-Hat Close
- 379 . Popular Hi-Hat Close
- 380 . Slam Hi-Hat Close
- 381 . Attack Hi-Hat Close
- 382 . Old Hi-Hat Close
- 383 . Fairfax Hi-Hat Close
- 384 . Military Hi-Hat Close
- 385 . Pop Hi-Hat Pedal
- 386 . Fuck Hi-Hat Pedal
- 387 . Hard Hi-Hat Pedal
- 388 . Original Hi-Hat Pedal
- 389 . PopRock Hi-Hat Pedal
- 390 . Rock Hi-Hat Pedal
- 391 . Metal Hi-Hat Pedal
- 392 . PowerMetal Hi-Hat Pedal
- 393 . SpeedMetal Hi-Hat Pedal
- 394 . PopJazz Hi-Hat Pedal
- 395 . Jazz Hi-Hat Pedal
- 396 . 808
- 397 . 909
- 398 . Songo Hi-Hat Pedal
- 399 . Standard Hi-Hat Pedal





# APPENDIX

400 . Acoustic Hi-Hat Pedal		433 . Seesion Crash2	450 . Fuck Crash2 Rim	467 . Blues Crash2 Rim
401 . Seesion Hi-Hat Pedal	417 . Pop Crash2	434 . Modern Crash2	451 . Hard Crash2 Rim	468 . Classic Crash2 Rim
402 . Modern Hi-Hat Pedal	418 . Fuck Crash2	435 . Blues Crash2	452 . Original Crash2 Rim	469 . Synthgaze Crash2 Rim
403 . Blues Hi-Hat Pedal	419 . Hard Crash2	436 . Classic Crash2	453 . PopRock Crash2 Rim	470 . Freak Crash2 Rim
404 . Classic Hi-Hat Pedal	420 . Original Crash2	437 . Synthgaze Crash2	454 . Rock Crash2 Rim	471 . Sticks Crash2 Rim
405 . Synthgaze Hi-Hat Pedal	421 . PopRock Crash2	438 . Freak Crash2	455 . Metal Crash2 Rim	472 . Grunge Crash2 Rim
406 . Freak Hi-Hat Pedal	422 . Rock Crash2	439 . Sticks Crash2	456 . PowerMetal Crash2 Rim	473 . 70's Crash2 Rim
407 . Sticks Hi-Hat Pedal	423 . Metal Crash2	440 . Grunge Crash2	457 . SpeedMetal Crash2 Rim	474 . 80's Crash2 Rim
408 . Grunge Hi-Hat Pedal	424 . PowerMetal Crash2	441 . 70's Crash2	458 . PopJazz Crash2 Rim	475 . Popular Crash2 Rim
409 . 70's Hi-Hat Pedal	425 . SpeedMetal Crash2	442 . 80's Crash2	459 . Jazz Crash2 Rim	476 . Slam Crash2 Rim
410 . 80's Hi-Hat Pedal	426 . PopJazz Crash2	443 . Popular Crash2	460 . 808	477 . Attack Crash2 Rim
411 . Popular Hi-Hat Pedal	427 . Jazz Crash2	444 . Slam Crash2	461 . 909	478 . Old Crash2 Rim
412 . Slam Hi-Hat Pedal	428 . 808	445 . Attack Crash2	462 . Songo Crash2 Rim	479 . Fairfax Crash2 Rim
413 . Attack Hi-Hat Pedal	429 . 909	446 . Old Crash2	463 . Standard Crash2 Rim	480 . Military Crash2 Rim
414 . Old Hi-Hat Pedal	430 . Songo Crash2	447 . Fairfax Crash2	464 . Acoustic Crash2 Rim	
415 . Fairfax Hi-Hat Pedal	431 . Standard Crash2	448 . Military Crash2	465 . Seesion Crash2 Rim	
416 . Military Hi-Hat Pedal	432 . Acoustic Crash2	449 . Pop Crash2 Rim	466 . Modern Crash2 Rim	

Crash 2

## Drum combination timbre

## User drum group

01 Pop	09 SpeedMetal	17 Seesion	25 70's
02 Fuck	10 PopJazz	18 Modern	26 80's
03 Hard	11 Jazz	19 Blues	27 Popular
04 Original	12 808	20 Classic	28 Slam
05 PopRock	13 909	21 Synthgaze	29 Attack
06 Rock	14 Songo	22 Freak	30 Old
07 Metal	15 Standard	23 Sticks	31 Fairfax
08 PowerMetal	16 Acoustic	24 Grunge	32 Military

## Demonstration music

Song 001	Song 007	Song 013	Song 019	Song 025
Song 002	Song 008	Song 014	Song 020	Song 026
Song 003	Song 009	Song 015	Song 021	Song 027
Song 004	Song 010	Song 016	Song 022	Song 028
Song 005	Song 011	Song 017	Song 023	Song 029
Song 006	Song 012	Song 018	Song 024	Song 030



# PRODUCT MAINTENANCE

Careful maintenance and protection of this product plays a very important role in prolonging the service life of the product and reducing faults.

### 1 Avoid heat, moisture or direct sunlight

Do not over expose the product to direct sunlight, or place it near the air conditioner or extremely hot place.

### 2 Do not use near TV or radio

This product may cause video or audio interference to the reception of TV and radio. If this happens, remove the product from the TV or radio.



## PRODUCT MAINTENANCE

### 3 Do not use paint, thinner or similar chemicals for cleaning

Please use a soft and dirt free cleaning cloth dipped in a small amount of water or special detergent to clean the surface stains of this product.

### 4 Do not shake to avoid collision

The product should be handled with care when moving. Violent vibration and collision are strictly prohibited to avoid damage to the shell or internal electronic components.



## SAFETY PRECAUTIONS

### POWER SUPPLY

This product can be powered by standard indoor wall sockets. Please only use the power cord specified in this product. When not in use, please turn off the power supply. When not in use for a long time, pull out the power cord and keep it properly.



### SIGN

To ensure that you use this product safely and correctly, to prevent harm to users and others and financial damage, this manual and products are marked with a series of safety signs. The various signs and their meanings are as follows:

#### **WARNING**

This sign indicates that there is a potential risk of death or serious injury if this mark is ignored and the product is mishandled.

#### **BE CAREFUL**

This sign indicates that there is a potential danger of injury to personnel or other financial damage if this sign is ignored and the product is operated incorrectly.

### EXAMPLE OF LOGO



This triangle sign ( $\Delta$ ) indicates what users should pay attention to. (The left example is careful shocks)



A circular sign ( $\ominus$ ) with an oblique line indicates prohibitions. The icons in or beside the logo indicate the contents specifically prohibited. (The example on the left is no disassembly)



The round black bottom sign ( $\oplus$ ) indicates what must be observed. The diagrams in this sign indicate the contents of the specific matters that must be observed. (The example on the left is that the power plug must be pulled out of the socket)



# SAFETY PRECAUTIONS









## ⚠ WARNING

### Smoke, odor, overheating

When the product smokes, smells or overheats, there is a danger of fire and electric shock when it is used continually. In case of the above situation, the following operations should be performed immediately:



1. Turn off the power supply.
2. Pull the plug out of the power outlet.
3. Contact your dealer.

### Power cord

1. The improper use of power cord may cause fire and electric shock. The following precautions must be observed:
  - The special power cord designated for this product must be used. 
  - The AC power supply with output voltage within the rated voltage range for household use must be used. 
  - Do not overload power sockets and extension lines. 
2. The improper treatment of power line will lead to its damage or breakage, which will cause fire and electric shock hazards. The following precautions must be observed:
  - Do not place or heat heavy objects on power lines. 
  - Do not attempt to alter or bend the power cord too much.
  - Do not twist or pull the power cord.
  - If the power cord or plug is damaged, please replace the same type of power cord. 
3. Do not touch the power cord and plug with wet hands, otherwise there is a danger of electric shock. 
4. Please use the power cord where the water will not splash. Water is in danger of causing fire and electric shock. 
5. Never place vases or any other container containing water on this product. Water is dangerous of causing fire and electric shock. 
6. Do not allow minors to unplug and touch power lines or connection boards. Minors have no common sense of electricity safety, which may cause electric shock. 

## ⚠ BE CAREFUL

The improper use of power cord may cause fire and electric shock. The following precautions must be observed:

- Never put the power cord near the oven or other heat source. 
- Do not pull the cable when pulling out of the power socket. The main body of the plug must be grasped.
- The power cord plug must be inserted in the socket to the end.
- Make sure the power supply is off before connecting or disconnecting it.
- When thunderstorms occur or before traveling or other long-term departure, disconnect the power cord from the wall outlet. 
- At least once a year, remove the power cord from the wall outlet and clean the dust accumulated around the plug.

### Do not burn this product

Do not put this product in the fire, otherwise it will lead to product combustion and explosion of internal electronic components, which will cause fire and personnel injury. 

### Water and foreign bodies

Water, other liquids and (metal sheets, etc.) entering this product are in danger of causing fire and electric shock. In case of the above situation, the following operations shall be performed immediately: 

1. Turn off the power supply.
2. If you are using a power cord for power supply, unplug it from the wall outlet.
3. Contact your distributor.

### Disassembly and transformation

Do not disassemble or transform the product in any way, otherwise there is a risk of electric shock, scald or other personal injury. All internal inspection, adjustment and maintenance operations should be entrusted to your distributor. 



## SAFETY PRECAUTIONS

### Falling or colliding

If the product falls or is damaged by strong impact, it will be in danger of causing fire and electric shock. In case of the above situation, the following operations shall be performed immediately:

1. Turn off the power supply.
2. If you are using a power cord for power supply, you need to unplug it from the wall outlet.
3. Contact your distributor.



### Plastic bag

Do not let anyone put plastic bags for this product on his head or in his mouth. Otherwise, there is a risk of asphyxia. Families with young children should pay special attention to it.



### Keep a distance from the product and the bracket

Climbing the bracket is dangerous of overturning or damage. Families with young children should pay special attention to it.



### Put

Avoid placing the product on an uneven surface or any other unstable place. Otherwise, it will cause the product to fall down, which will lead to the risk of injury.



### Product Mobility

Before moving this product, you must unplug the power cord plug from the wall outlet and pull out all other cables and connecting wires. Otherwise, it will lead to damage of power or connection wires, resulting in fire and electric shock.



### clean

Before cleaning this product, you must unplug the power cord plug from the wall outlet, otherwise there is a risk of fire and electric shock.



### Jack

The socket of this product can only be connected to the designated equipment and devices. Connecting non-designated equipment or devices is dangerous of causing fire and electric shock.



### Location selection

It should be avoided to place the product in the following places, otherwise there is a risk of fire and electric shock.



- High temperature or dusty places.
- Kitchen or other places with lampblack.
- Where the product is exposed to direct sunlight, or any other place where the product will produce high temperature.

### Volume

Don't play music long and loud. Pay special attention when using headphones. Excessive volume can damage your hearing.



### Heavy



Do not place heavy objects on this product. Otherwise, the top of the product will be overweight, causing the product to overturn or drop objects on it, which will lead to the risk of injury.



### Correct assembly of scaffolds

The incorrect assembly of the bracket may overturn, causing the product to fall off and posing a risk of injury to personnel. Therefore, it must be assembled according to the instructions in the attached installation guide to ensure that the product is properly mounted on its bracket.



	<p>Warning-To reduce the risk of injury, user must read instructions manual carefully.</p>
	<p>This device complies with Part 15 of the FCC Rules. Operation is subject to the following two conditions:(1)This device may not cause harmful interference, and (2)this device must accept any interference received, including interference that may cause undesired operation.</p>
	<p>This product is subject to the provision of European Directive 2012/19/EC. The symbol showing a wheeled bin crossed through indicates that the product requires separate refuse collection in the European Union. This applies to the product and all accessories marked with this symbol. Products marked as such may not be discarded with normal domestic waste, but must be taken to a collection point for recycling electrical and electronic devices</p>

**Manufacturer:** Shanghaimuxinmuyeyouxiangongsi

**Address:** Shuangchenglu 803nong11hao1602A-1609shi, baoshanqu, shanghai 200000 CN.

**Imported to AUS:** SIHAO PTY LTD, 1 ROKEVA STREETEASTWOOD NSW 2122 Australia

**Imported to USA:** Sanven Technology Ltd., Suite 250, 9166 Anaheim Place, Rancho Cucamonga, CA 91730

<p><b>EC</b></p>	<p><b>REP</b></p>
------------------	-------------------

E-CrossStu GmbH  
Mainzer Landstr.69, 60329 Frankfurt am Main.

<p><b>UK</b></p>	<p><b>REP</b></p>
------------------	-------------------

YH CONSULTING LIMITED.  
C/O YH Consulting Limited Office 147, Centurion House,  
London Road, Staines-upon-Thames, Surrey, TW18 4AX



**VEVOR<sup>®</sup>**

**TOUGH TOOLS, HALF PRICE**

**Technical Support and E-Warranty Certificate**

**[www.vevor.com/support](http://www.vevor.com/support)**

# VEVOR®

## TOUGH TOOLS, HALF PRICE

Assistance technique et certificat de garantie

électronique [www.vevor.com/support](http://www.vevor.com/support)

### BATTERIE ÉLECTRONIQUE

#### MANUEL DE L'UTILISATEUR

MODÈLE : MD200F-

Nous continuons à nous engager à vous fournir des outils à des prix compétitifs.

"Économisez la moitié", "Moitié prix" ou toute autre expression similaire que nous utilisons ne représente qu'une estimation des économies dont vous pourriez bénéficier en achetant certains outils chez nous par rapport aux grandes marques et ne signifie pas nécessairement couvrir toutes les catégories d'outils. proposés par nos soins. Nous vous rappelons de bien vouloir vérifier attentivement lorsque vous passez une commande chez nous si vous économisez réellement la moitié par rapport aux grandes marques.

**VEVOR**<sup>®</sup>  
TOUGH TOOLS, HALF PRICE

BATTERIE ÉLECTRONIQUE

MODÈLE : MD200F-P F

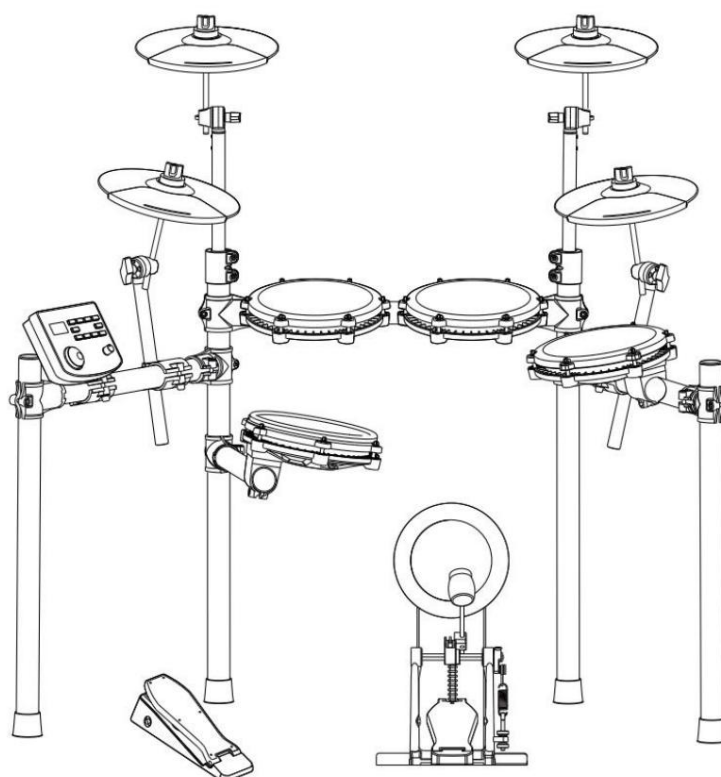

(L'image est à titre de référence seulement, veuillez vous référer à l'objet réel )

### BESOIN D'AIDE? CONTACTEZ-NOUS!

Vous avez des questions sur les produits ? Besoin d'une assistance technique ? N'hésitez pas à contactez-

nous : support technique et certificat de garantie électronique

[www.vevor.com/support](http://www.vevor.com/support)

Il s'agit des instructions originales, veuillez lire attentivement toutes les instructions du manuel avant de l'utiliser. VEVOR se réserve une interprétation claire de notre manuel d'utilisation. L'apparence du produit dépend du produit que vous avez reçu. Veuillez nous pardonner que nous ne vous informerons plus s'il y a des mises à jour technologiques ou logicielles sur notre produit.



## INTRODUCTION DES FONCTIONS

Merci d'avoir choisi notre batterie électronique. La batterie électronique élégante et délicate est la combinaison parfaite de la nouvelle technologie électronique moderne. •Avant d'utiliser ce produit, vous devez lire les instructions en détail.

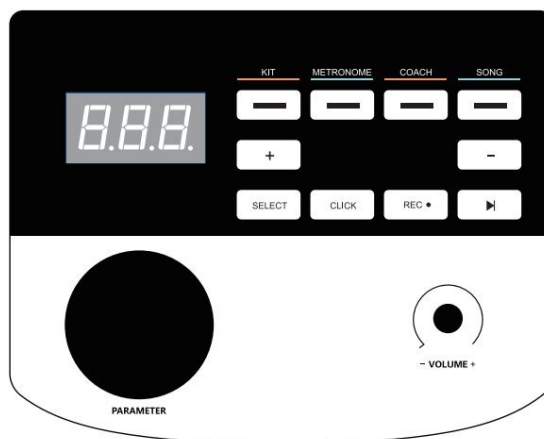

- 32 sets de batterie, 480 timbres
- 30 chansons
- Prise en charge de l'ajustement des paramètres de sensibilité de chaque tambour
- Trois modes d'enseignement
- Contrôle de vitesse : 30 ~ 250 battements/min
- Métronome : 1 à 9 types
- Autres fonctions : stockage, réinitialisation et enregistrement des paramètres ;
- affichage LED à trois chiffres ;
- interface : alimentation cc, usbmidi, écouteur, entrée audio, sortie audio

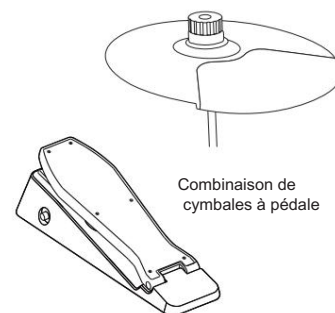
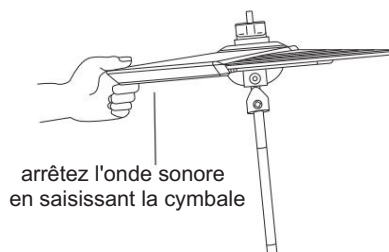
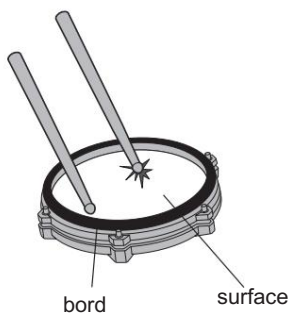

### REMARQUE!

- Ce produit est un instrument électro-acoustique. Il est normal qu'il y ait un petit son actuel dans le haut-parleur ou les écouteurs après la mise sous tension.

Tenir à l'écart de « la radio, de la télévision, du récepteur d'antenne, du routeur, du réfrigérateur, de la télévision, du moteur et d'autres sources d'interférences électriques RF » pendant l'utilisation.



# CONTENU

INTRODUCTION DES FONCTIONS	1
CONTENU	2
GUIDE D'INSTALLATION	3
VÉRIFIEZ LES ÉLÉMENTS CI-JOINTS	3
SUPPORT DE TUYAU LRON	4
INTUBATION TYMPANIQUE	4
SUPPORT DE MONTAGE	5
INSTALLER LE MODULE DE TAMBOUR	5
INSTALLER LES PIÈCES DE FRAPPAGE ET LE MODULE DE SON	6
INSTALLER LA TAMBOUR DE KICK	7
INSTALLER LA BARRE À MARTEAU	7
LE KICK DRUM EST FIXÉ AVEC LE STEP HAMMER	7
BRANCHEZ LE CÂBLE DE RACCORDEMENT DE LA PIÈCE DE FRAPPEUR	7
ILLUSTRATION DU PORT DU MODULE SON	8
CONNEXION DU CORDON D'ALIMENTATION	8
PORT MIDI USB	8
PORT DE SORTIE AUDIO	8
PORT D'ENTRÉE AUDIO	8
PORT POUR ÉCOUTEURS	8
AUGMENTER LE PORT	8
MODE BT	8
GUIDE D'OPÉRATION	9
POUVOIR	9
SÉLECTION DU KIT DE BATTERIE	9
MÉTRONOME	9
FONCTION PRATIQUE	9
MODE ENTRAÎNEUR	9
CHANSONS DE DÉMO	dix
PARAMÈTRES DU TAMBOUR	dix
FONCTION D'ENREGISTREMENT	dix
ENREGISTRER / RÉINITIALISER	dix
USB-MIDI	11
ANNEXE	11
TIMBRE	11
KITS DE BATTERIE PRÉRÉGLÉS	11
KITS DE BATTERIE DÉFINIS PAR L'UTILISATEUR	11
CHANSON DE DÉMO STRATION	11
ENTRETIEN DU PRODUIT	12
PRÉCAUTIONS DE SÉCURITÉ	13



# GUIDE D'INSTALLATION

## REMARQUE!

- Veuillez suivre les instructions et lire attentivement les « précautions de sécurité » dans le manuel d'utilisation avant d'utiliser .
- Ce produit doit être installé par un adulte, veuillez ne pas laisser un mineur l'installer indépendamment.

# 01

## Vérifiez les éléments joints

- Après avoir ouvert le colis, veuillez vérifier immédiatement s'il contient tous les éléments. En cas d'omissions, veuillez contacter votre revendeur.



Module sonore



Support de module



Cymbale \*4

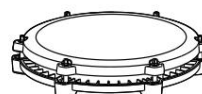

Tom (3 pièces)



Piège



Support arrière



Support de connexion



Support avant



Coup

2 PIÈCES 2 PIÈCES 6 PIÈCES



vis

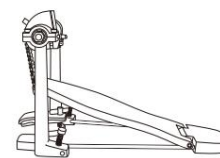

Pédale de grosse caisse



Bras de cymbale  
(4 pièces)



Salut chapeau pédale



Tournevis



Câble de connexion des signaux

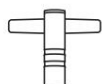

Clé de batterie



Adaptateur secteur



Baguette de tambour



Marteau à bâton



## DESSIN D'ASSEMBLAGE

### 02

#### support de tuyau en fer

•Le support est situé dans un petit emballage individuel à l'intérieur de la boîte.

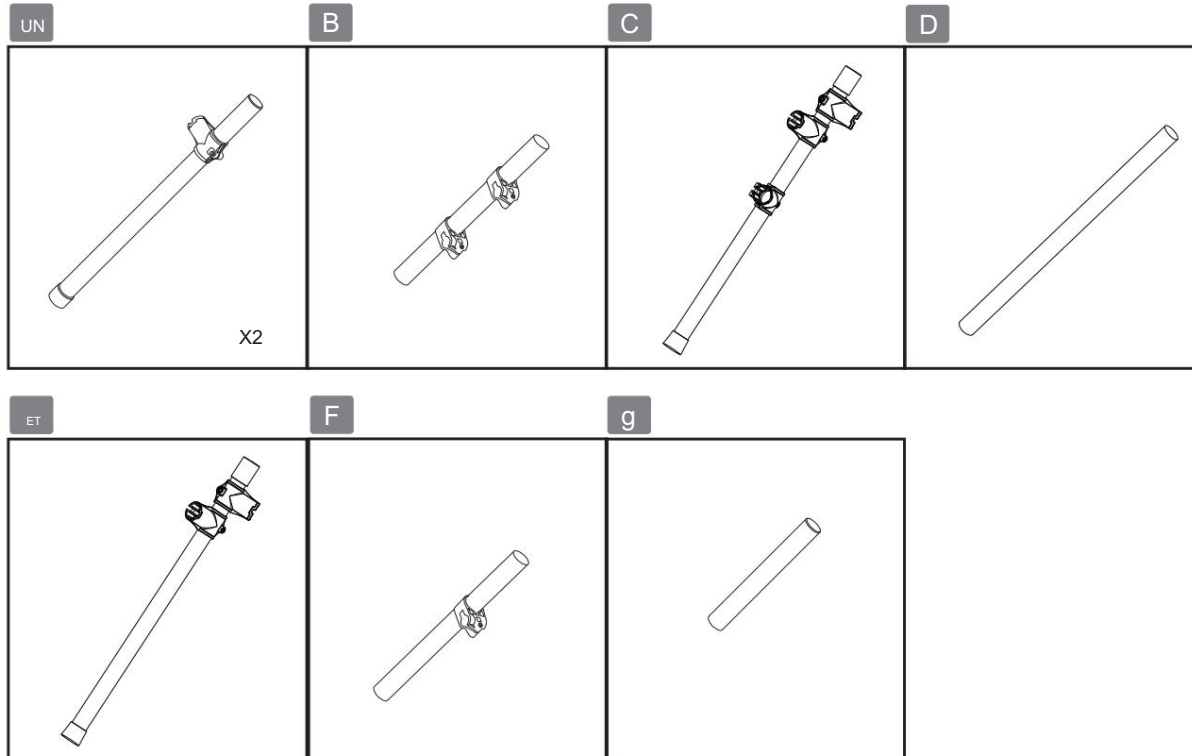

### 03 Intubation tympanique

Installez le tambour sur la barre de support du tambour.

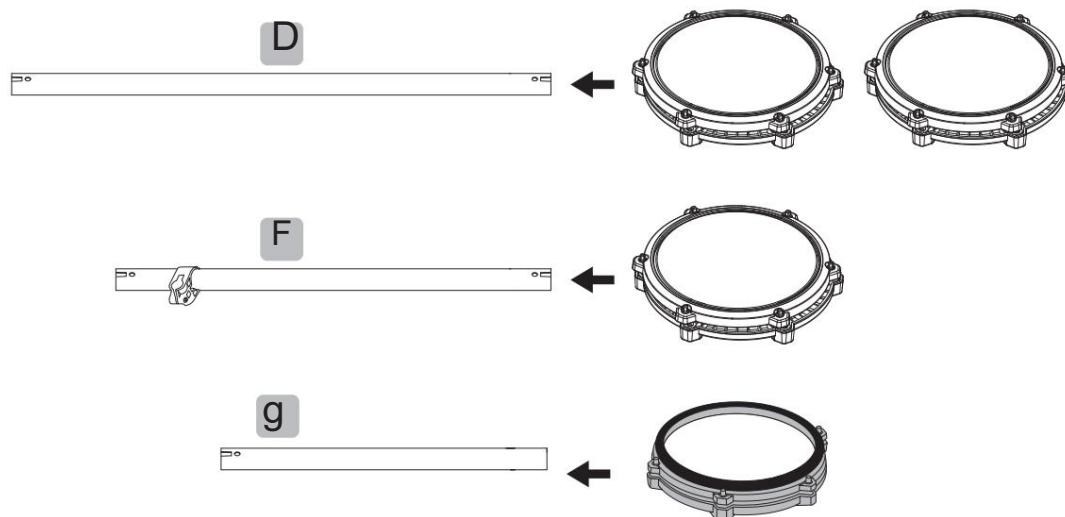



## GUIDE D'INSTALLATION

### 04

#### Support de montage

- Lors de l'installation, serrez les vis et veillez à vous pincer les doigts.
- Assemblez le support dans la direction spécifiée

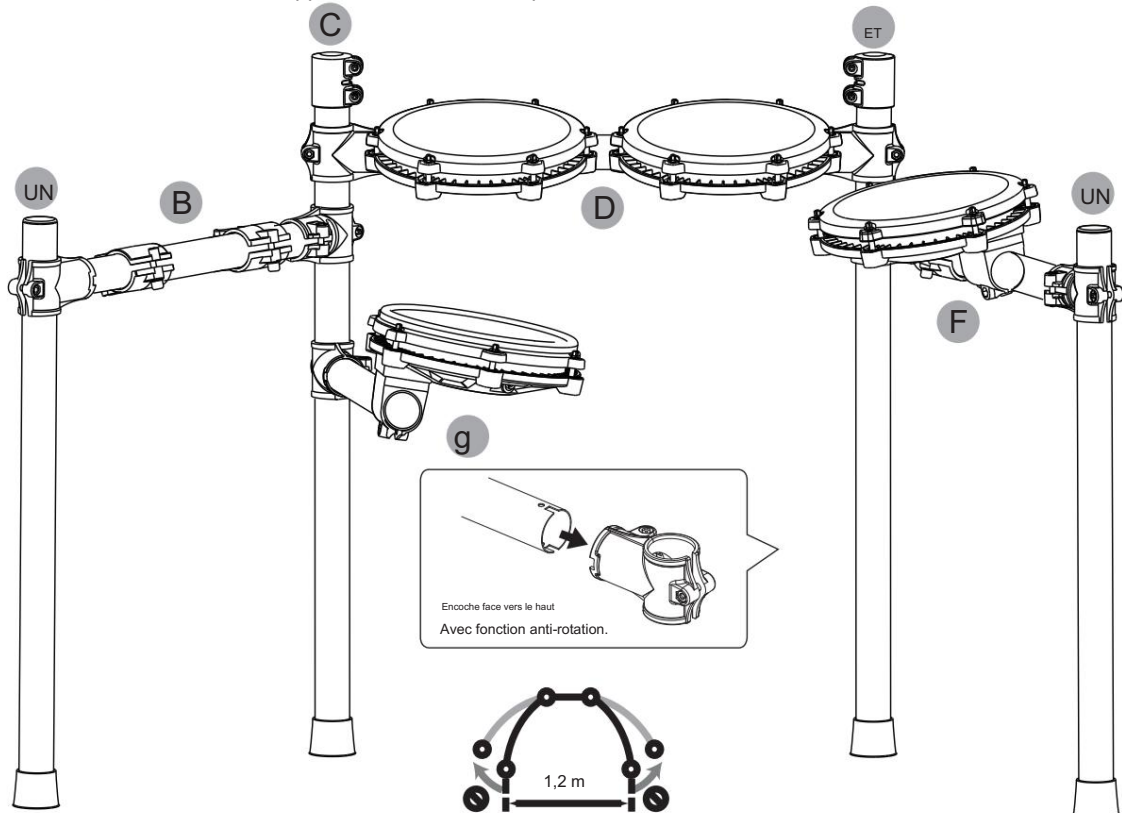

Pour des raisons de sécurité, la largeur d'expansion du support ne doit pas dépasser 1,2 mètre.

### 05

#### Installez le module de batterie

- Veuillez l'insérer en place pendant le décrochage.

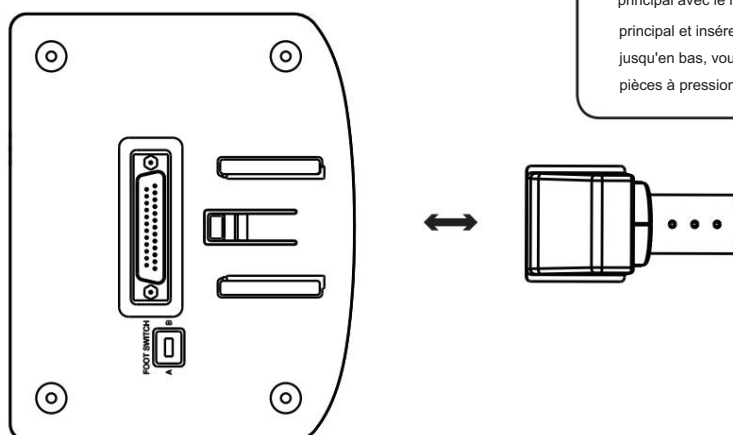

Alignez le module de batterie du châssis principal avec le rail du boîtier du châssis principal et insérez-le. Après l'avoir inséré jusqu'en bas, vous pouvez entendre les pièces à pression apparaître.



## GUIDE D'INSTALLATION

# 06

### Installer les pièces frappantes et le module sonore

- Serrez les vis une fois le tambour inséré pour éviter de le desserrer.
- Assurez-vous de ne pas trop serrer la cymbale, laissez-lui un peu d'espace pour qu'elle serpente de haut en bas.

Retirez les écrous et les coussinets circulaires des trois bras de cymbales, placez les trois cymbales dans le bras correspondant et vissez les écrous. Placez respectivement 3 tambours et 1 tambour dans la tige de support correspondante et serrez les vis. Attention : les fonctions de chaque cymbale, Tom drum et caisse claire sont différentes, il faut donc se référer à l'identification de l'accessoire pour une bonne installation !

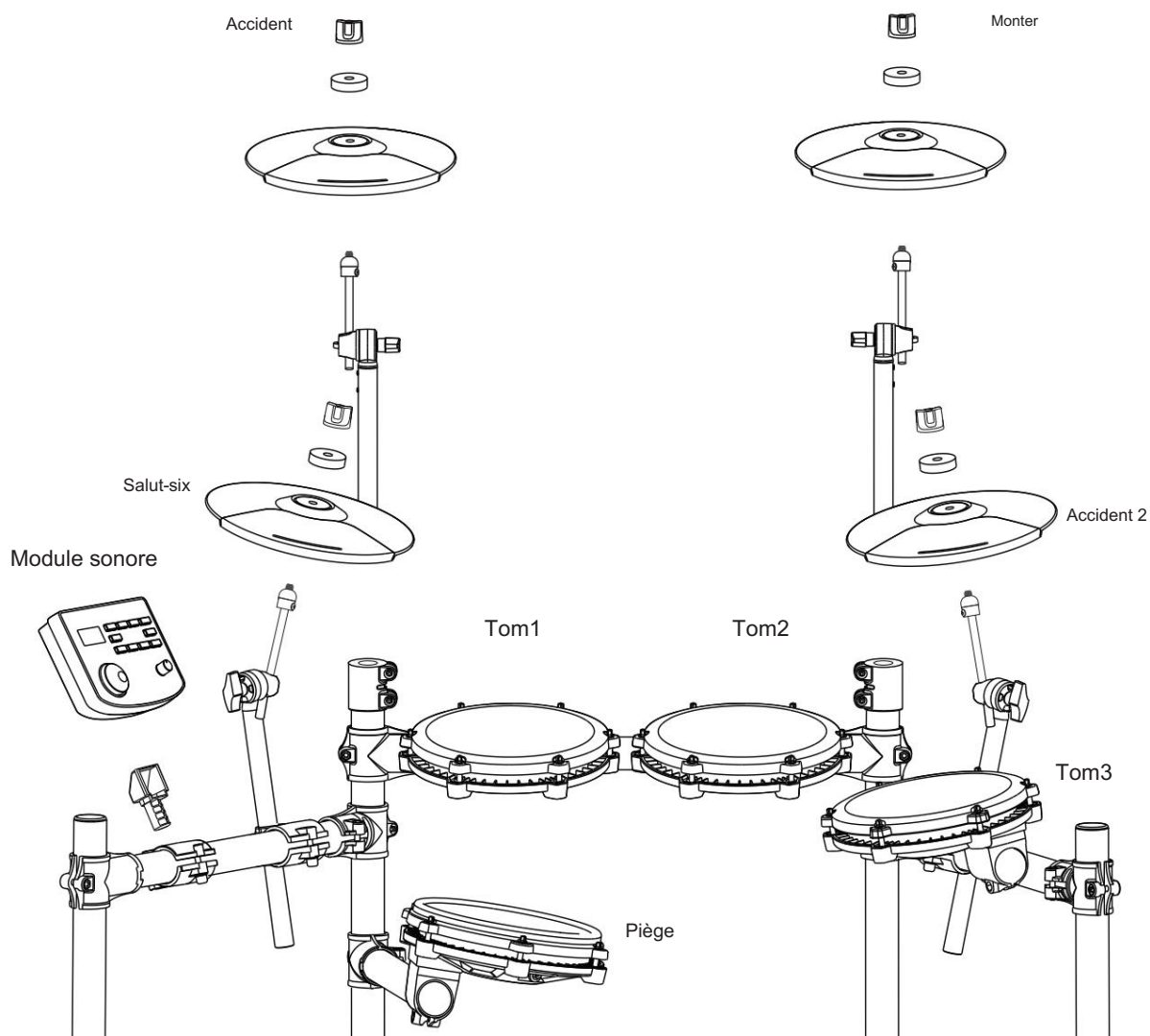



## GUIDE D'INSTALLATION

### 07

#### Installer la grosse caisse

- lors de l'installation, veuillez serrer les vis et veillez à ne pas vous pincer les doigts.

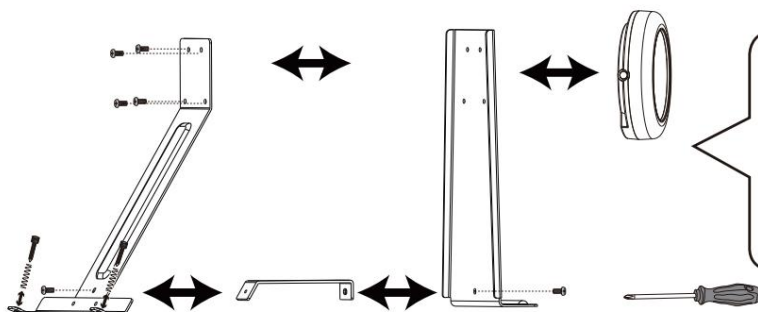

Utilisez un tournevis pour fixer le tambour inférieur, les fixations comme indiqué, pièces de support avec 6 petites vis. Mettez ensuite 2 ressorts dans 2 vis antidérapantes et verrouillez les 2 ressorts dans le bas de la pièce de support jusqu'à ce qu'elle repose sur le sol.

### 08

#### Installer la barre de marteau

- le mât doit être inséré dans le lacet et les vis doivent être serrées pour éviter de se desserrer.

Insérez la tige du marteau dans le trou rond comme indiqué sur la figure, faites tourner le marteau en laine pour l'aligner avec la surface du tambour, puis serrez-le avec la clé du tambour.

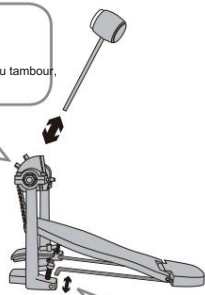
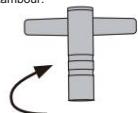

Insérez la barre de fer fixe dans le trou comme le montre la figure.

### 09

#### La grosse caisse est fixée avec le marteau de marche

- le tambour inférieur et le marteau-marteau doivent être fixés et serrés pour éviter de tomber.

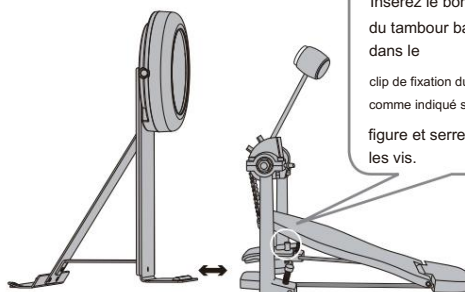

Insérez le bord saillant du tambour bas dans le clip de fixation du marteau comme indiqué sur la figure et serrez les vis.



### dix

#### Brancher le câble de connexion de la pédale

- Veuillez insérer le câble de connexion en place pour éviter un mauvais contact et insérez-le correctement comme indiqué sur le schéma.

Veuillez vérifier si le tambour inférieur émet du son. S'il n'y a pas de son, veuillez tourner l'interrupteur :  
Switch en A : mode grosse caisse mécanique  
Switch en B : mode pédale.

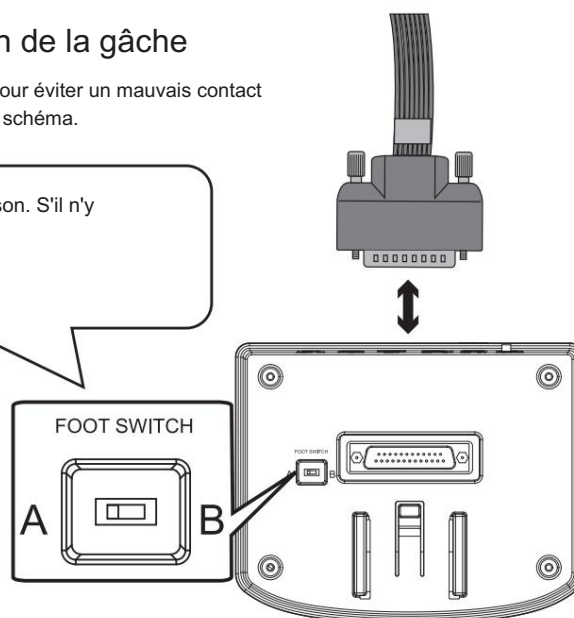



## ILLUSTRATION DU PORT DU MODULE SON

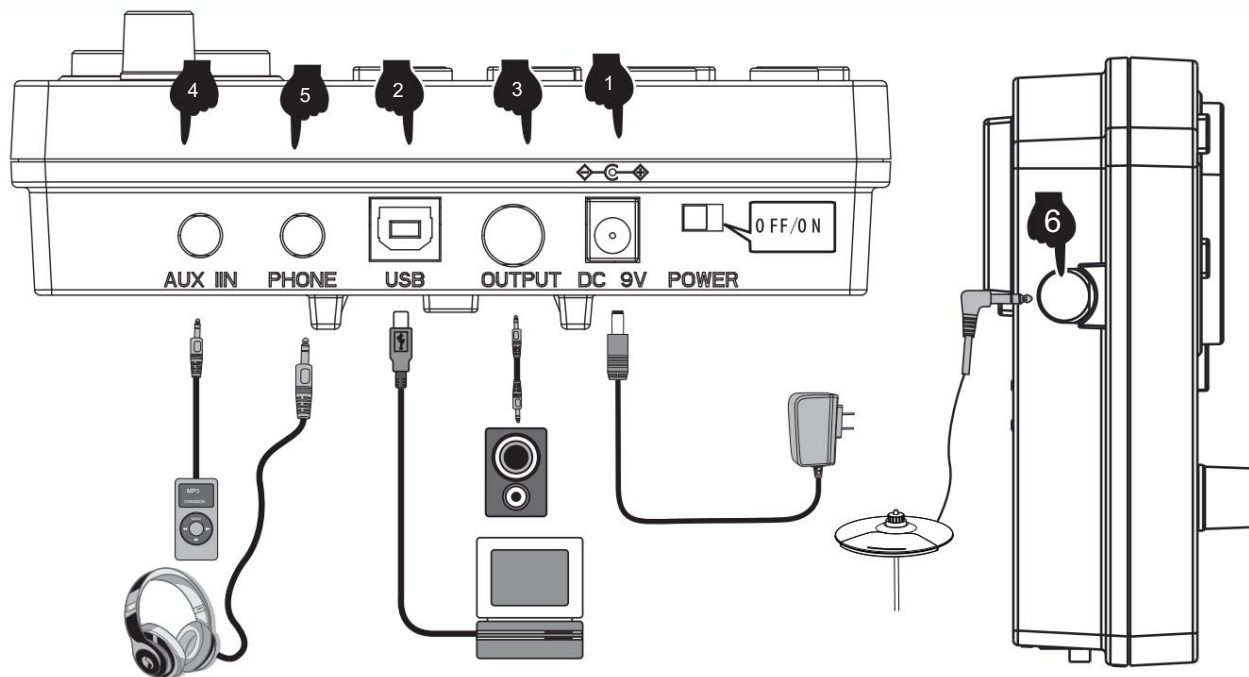

### 1 CONNEXION DU CORDON D'ALIMENTATION

1. Lors de l'utilisation, connectez la borne d'alimentation selon le schéma, insérez la prise de courant du module de son à une extrémité et une prise de courant domestique 100-240 V à l'autre extrémité. (Fig. 1)
2. Si vous n'utilisez pas ce produit pendant une longue période, veuillez débrancher la fiche d'alimentation et la conserver correctement.

### 2 ports USB-MIDI

L'utilisation de l'interface MIDI USB de batterie électronique peut interagir avec des appareils de musique avec MIDI.

1. Grâce au logiciel Musique préinstallé sur les ordinateurs et les téléphones portables, nous pouvons apprendre à jouer, composer musique, magasin et autres fonctions. (Fig.2)
2. Lorsqu'il est connecté à un ordinateur ou à un téléphone portable, la sortie audio de l'appareil doit être connectée à la prise d'entrée audio du module box afin de synchroniser les effets sonores sur l'appareil. (Fig.5)

### 3 PORTS DE SORTIE AUDIO

Le port de sortie audio peut être connecté à un haut-parleur actif (haut-parleur de batterie électronique spécial) et à un grand équipement audio. (Fig.3)

### 4 PORTS D'ENTRÉE AUDIO

Le port d'entrée audio peut connecter le périphérique de lecture de source sonore au boîtier de module pour la lecture (comme MP3. Téléphone mobile et autre entrée de signal audio). (Fig.4)

### 5 PORTS ÉCOUTEURS

La connexion d'un casque surveille les détails des percussions et ne dérange pas les autres lorsque vous jouez sans connexion. haut-parleurs. (Fig.5)

### 6 AUGMENTER LE PORT

Ce port vous permet d'ajouter une cymbale pour une extension facile. (Figure 6)



## GUIDE D'OPÉRATION

### 1 PUISSANCE

Insérez la fiche DC dans le port DC 9V sur le dessus de l'unité de commande. Faites glisser le commutateur POWER vers la droite (vu de l'avant) pour alimenter le kit de batterie. Pour éteindre le kit de batterie, faites glisser le commutateur vers la gauche.

### 2 SÉLECTION DE KITS DE BATTERIE

Appuyez sur le bouton KIT pour afficher le kit de batterie actuel. Tournez la molette de paramètres ou utilisez les boutons <- /+> pour sélectionner le kit de batterie. Vous avez le choix entre 32 kits de batterie - voir la liste des kits de batterie à la page 11.

### 3 MÉTRONOME

- Appuyez sur le bouton METRONOME pour accéder au mode métronome.
- L'écran affichera la valeur de la vitesse (vitesse par défaut de 120 BPM). Tournez la molette de paramètres ou utilisez les boutons +/- pour changer la vitesse du métronome. Appuyez sur le bouton CLICK pour démarrer le métronome.
- Appuyez sur le bouton SELECT en mode métronome et l'écran passera au réglage des paramètres du métronome.
  - interface. Vous pouvez appuyer sur les boutons +/- pour sélectionner le paramètre que vous souhaitez régler :
  - A. r (type de battement : 2,4,8,16)
  - B. b (numéro de temps : 01-09)
  - C. L (volume du métronome : 00 (arrêt) -31), puis tournez la molette de paramètres pour régler les paramètres.
- Une fois les paramètres ajustés, appuyez sur le bouton SELECT pour confirmer et quitter l'interface des paramètres. Ensuite utilisez le bouton CLICK pour démarrer et arrêter le métronome comme vous le souhaitez.

### 4 FONCTION PRATIQUE

Le mode entraîneur « coach » de ce produit peut aider à établir la vitesse, la précision et l'endurance, et aider à cultiver la fonction de pratique d'un meilleur sens du rythme. Progressez sous la supervision du mode coach « coach » !

Appuyez sur le bouton « coach » pour accéder au mode coach. Dans ce mode, il existe trois modes d'entraînement. Sélectionnez la pratique mode via la molette de données ou le bouton <+ > <- >.

- Mode d'exercice 1 : exercice de détection de battement C-1 : battez le tambour à une vitesse fixe pour entraîner la précision du coup.
- Mode d'entraînement 2 : mode de frappe silencieuse C-2 : le métronome sonnera une section et coupera une section pour entraîner la précision de frappe sans invite de métronome. Il s'agit d'une version avancée du mode pratique 1.
- Mode d'entraînement 3 : entraînement de frappe de vitesse C-3, le métronome changera automatiquement la vitesse, augmentera de l'express le plus lent au plus rapide, puis réduisez de l'express le plus lent à la vitesse la plus lente, de manière à pratiquer l'endurance de frappe.

### 5 MODE ENTRAÎNEUR

- Le mode d'entraînement « coach » de ce produit peut aider à établir la vitesse, la précision et l'endurance. Appuyez sur le bouton COACH bouton pour accéder au mode coach. Dans ce mode, il existe trois modes d'entraînement. Utilisez la molette de paramètres pour sélectionner quel mode de pratique.
  - A. Mode d'exercice 1 : Exercice de détection de battement C-1 - battez le tambour à une vitesse fixe pour entraîner la précision du coup.
  - B. Mode d'entraînement 2 : mode de frappe silencieuse C-2 - le métronome sonnera une section et coupera une section pour s'entraîner quand il n'y a pas de battement.
  - C. Mode d'entraînement 3 : entraînement de frappe de vitesse C-3 - le métronome changera automatiquement la vitesse de la plus lente au plus rapide puis du plus rapide au plus lent.
- Une fois le mode coaching choisi, appuyez sur le bouton CLIC. Les battements du métronome commenceront et vous pourrez jouer sur le tambour pour vous entraîner.
- Après quatre battements préliminaires, l'écran affichera :

(trop lent)



(bien)



(trop vite)





## GUIDE D'OPÉRATION

4. Une fois que vous avez terminé le mode coaching, un score s'affichera de 0 à 100 évaluant l'exactitude de l'exercice.

Mode C-1 : appuyez sur le bouton SELECT pour accéder à l'interface de réglage des paramètres. Vous pouvez ajuster le nombre de pratique séances selon les besoins (01-32). Le nombre de séances à pratiquer détermine la durée de cet exercice.

Mode C-2 : appuyez sur le bouton SELECT pour accéder à l'interface de réglage des paramètres. Vous pouvez ajuster le nombre de séances d'entraînement selon vos besoins (04-32). Le nombre de séances à pratiquer détermine la durée de cet exercice.

Mode C-3 : appuyez sur le bouton SELECT pour accéder à l'interface de réglage des paramètres. Vous pouvez ajuster la vitesse à laquelle le BPM changements (01-09 BPM).

5. Appuyez à nouveau sur le bouton CLIC pour quitter le mode coach.

### 6 MORCEAUX DE DÉMO

1. Appuyez sur le bouton SONG pour accéder au mode démo, vous avez le choix entre 30 démos. L'écran affichera le courant numéro du morceau de démonstration (01 -30).

2. Appuyez sur le bouton < > pour lancer la lecture des morceaux de démonstration. Pour arrêter la lecture, appuyez à nouveau sur la touche < >.

3. Tournez la molette de paramètres ou appuyez sur les boutons +/- pour sélectionner un morceau de démonstration.

4. Appuyez sur le bouton SELECT en mode chanson pour accéder à l'interface de réglage des paramètres de la chanson. Vous pouvez activer le son de la batterie. ou désactivé en tournant la molette de paramètres (le son de batterie est activé par défaut).

5. Appuyez sur le bouton SELECT pour confirmer et quitter l'interface des paramètres.

### 7 PARAMÈTRES DU TAMBOUR

1. Appuyez sur le bouton KIT et l'écran affichera 01 (numéro du kit de batterie). Appuyez sur SELECT pour entrer dans le paramètre de batterie mode de réglage.

2. Appuyez sur le tambour que vous souhaitez régler, puis appuyez sur les boutons +/- pour sélectionner le paramètre à régler. Sensibilité

A. S(01-06). Seuil de déclenchement ((01 - 32).

Seuil de diaphonie c (01 -32)

B. Déclenchement répété r(01-32) Force du tambour

V(01-03). Volume du tambour L (00 - 31).

3. Modifiez les paramètres en tournant la molette des paramètres et appuyez longuement sur le bouton - pour enregistrer. L'écran avec affichage SAV pour indiquer que le réglage des paramètres a été enregistré avec succès.

4. Pour restaurer les paramètres du tambour aux paramètres d'usine, appuyez longuement sur le bouton + jusqu'à ce que l'écran affiche RES.

5. VEUILLEZ NOTER : Les paramètres des 3 toms ne peuvent pas être réglés individuellement.

### 8 FONCTION D'ENREGISTREMENT

1. Appuyez sur le bouton < REC > lorsque le voyant est dans les états « KIT » et « CLICK », et l'écran affiche le Mots « REC » dans l'état de clignotement respiratoire, entrant dans l'état de préparation d'enregistrement.

2. Appuyez sur n'importe quel tambour et le métronome sonne. À ce moment, l'écran affiche "----" en état de respiration clignotante et commence l'enregistrement.

3. Appuyez à nouveau sur la touche < REC > ou < PLAY >, l'enregistrement s'arrête et « A-1 » s'affiche à l'écran.

4. Appuyez sur < ▶ | > pour démarrer la lecture de l'enregistrement en cours, puis appuyez à nouveau pour arrêter la lecture.

5. Si vous entrez à nouveau dans l'état de préparation à l'enregistrement sans aucun coup, le "A-1" enregistré la dernière fois est lu.

### 9 ENREGISTRER / RÉINITIALISER

1. Pour enregistrer les paramètres, appuyez longuement sur le bouton <-> et l'écran affichera SAV.

2. Pour réinitialiser les paramètres, appuyez longuement sur le bouton <+> et l'écran affichera RES res.

### 10 USB-MIDI

Pour utiliser la fonction MID des kits de batterie, branchez un câble de données USB-B (non inclus avec ce kit de batterie) dans l'unité de commande et connectez-le au PC/smartphone.



## ANNEXE

## Timbre

Coup .	70 . Jante de caisse claire Rock	134 . Rocher Tom2	198 . Crash de roche1	262 . Balade rocheuse	326 . Rock Charleston ouvert 327 .
1 . Pop Coup de Pied	71 . Jante de caisse claire en métal	135 . Métal Tom2	199 . Crash de métal1	263 . Balade en métal	Charleston en métal ouvert 328 .
2 . Putain de coup de pied	72 . Jante de caisse claire PowerMetal	136 . Power Metal Tom2	200 . Crash de PowerMetal1	264 . Tour PowerMetal	Hi-Hat PowerMetal ouvert 329 . Charleston
3 . Coup de pied dur	73 . Jante de caisse claire SpeedMetal	137 . SpeedMétal Tom2 138 .	201 . Crash de SpeedMetal1 202 .	265 . Tour SpeedMetal	SpeedMetal ouvert 330 . PopJazz
4 . Coup de pied original	74 . Jante de caisse claire PopJazz	PopJazz Tom2	PopJazz Crash1 203 . Crash de	266 . Tour PopJazz	Charleston ouvert 331 . Jazz
5 . Coup de pied PopRock	75 . Jante de caisse claire Jazz	139 . JazzTom2	Jazz1	267 . Balade Jazz	charleston ouvert
6 . Coup de pied rocheux	76 . 808	140 . 808	204 . 808	268 . 808	332 . 808
7 . Coup de pied en métal	77 . 909	141 . 909	205 . 909	269 . 909	333 . 909
8 . Coup de pied PowerMetal	78 . Jante de caisse claire Songo	142 . Songo Tom2	206 . Crash de Songo1 207 .	270 . Songo rit	334 . Songo charleston ouvert 335 .
9 . Coup de pied SpeedMetal	79 . Jante de caisse claire standard	143 . Tome 2 standard	Crash standard1	271 . Balade standard	Charleston standard ouvert 336 .
10 . Coup de pied PopJazz	80 . Jante de caisse claire acoustique	144 . Tom2 acoustique	208 . Crash acoustique1	272 . Balade acoustique	Charleston acoustique ouvert 337 .
11 . Coup de pied de jazz	81 . Jante de caisse claire Seesion	145 . Séance Tom2	209 . Crash de session1	273 . Balade de séance	Seesion Charleston ouvert 338 .
12 . 808	82 . Jante de caisse claire moderne	146 . Tom2 moderne	210 . Crash moderne1	274 . Balade moderne	Charleston moderne ouvert 339 .
13 . 909	83 . Jante de caisse claire Blues	147 . BluesTom2	211 . Blues-Crash1	275 . Balade en Blues	Charleston Blues ouvert 340 .
14 . Songo Coup de	84 . Jante de caisse claire classique	148 . Classique Tom2	212 . Crash classique1	276 . Balade classique	Charleston classique ouvert 341 .
pied 15 . Coup de pied standard	85 . Jante de caisse claire Synthgaze	149 . Synthgaze Tom2	213 . Crash de Synthgaze1 214 .	277 . Tour de synthgaze	Synthgaze Charleston ouvert 342 . Freak
16 . Coup de pied acoustique	86 . Jante de caisse claire Freak	150 . Monstre Tom2	Crash normal1	278 . Tour bizarre	Charleston ouvert 343 . Baguettes
17 . Coup de pied de séance	87 . Baguettes Caisse Claire	151 . Bâtons Tom2	215 . Bâtons Crash1	279 . Balade en bâtons	Hi-Hat Ouvertes 344 . Charleston
18 . Coup de pied moderne	88 . Jante de caisse claire grunge	152 . Tom2 grunge	216 . Crash grunge1 217 .	280 . Tour grunge	Grunge Ouvert 345 . Charleston ouvert
19 . Coup de pied de blues	89 . Jante de caisse claire des années 70	153 . Tom2 des années 70	Crash des années 701	281 . Balade des années 70	des années 70 346 . Charleston
20 . Coup de pied classique	90 . Jante de caisse claire des années 80	154 . Tom2 des années 80	218 . Crash des années 801	282 . Balade des années 80	ouvert des années 80 347 .
21 . Coup de pied synthétisé	91 . Jante de caisse claire populaire	155 . Populaire Tom2	219 . Crash populaire1 220 .	283 . Balade populaire	Charleston populaire ouvert 348 . Slam
22 . Coup de pied anormal	92 . Jante de caisse claire Slam	156 . Claquer Tom2	Slam Crash1	284 . Tour de slam	Charleston ouvert 349 . Attaque
23 . Coup de bâton	93 . Jante de caisse claire d'attaque	157 . Attaque Tom2	221 . Attaque Crash1	285 . Tour d'attaque	Charleston ouvert 352 . Charleston
24 . Coup de pied grunge 25 .	94 . Vieille jante de caisse claire	158 . Vieux Tom2	222 . Vieux crash1	286 . Vieux tour	militaire ouvert 353 . Pop Charleston
Coup de pied des années 70	95 . Jante de caisse claire Fairfax	159 . Fairfax Tom2	223 . Crash de Fairfax1	287 . Tour de Fairfax	Fermer
26 . Coup de pied des années 80	96 . Jante de caisse claire militaire	160 . Militaire Tom2 161 .	224 . Crash militaire1 225 .	288 . Tour militaire	354 . Fuck Hi-Hat Fermer
27 . Coup de pied populaire		Pop Tom3	Pop Crash1 Jante 226 . Baise	289 . Jante Pop Ride	355 . Fermer le charleston rigide
28 . Coup de pied claquant		162 . Putain Tom3	Crash1 Jante	290 . Baise Ride Rim	356 . Charleston original Fermer 357 .
29 . Coup de pied d'attaque		163 . Difficile Tom3	227 . Jante Hard Crash1	291 . Jante dure	Charleston PopRock Fermer
30 . Vieux coup de pied	A M .	164 . Tom3 165 d'origine.	228 . Jante Crash1 d'origine 229.	292 . Jante originale	358 . Charleston Rock Fermer
31 . Coup de pied de Fairfax		PopRock Tom3	Jante PopRock Crash1 230 . Jante Rock	293 . Complète PopRock Ride	359 . Charleston en métal
32 . Coup de pied militaire		166 . Rocher Tom3	Crash1	294 . Jante Rock Ride	360 . Charleston PowerMetal Fermer
		167 . Métal Tom3	231 . Jante Metal Crash1	295 . Jante en métal	361 . Charleston SpeedMetal Fermer 362 .
		168 . Power Metal Tom3	232 . Jante PowerMetal Crash1	296 . Jante PowerMetal Ride	Charleston PopJazz Fermer
		169 . SpeedMétal Tom3 170 .	233 . Jante SpeedMetal Crash1 234 .	297 . Jante SpeedMetal Ride	363 . Charleston Jazz Fermer
		PopJazz Tom3	PopJazz Crash1 Jante 235 . Jante Jazz	298 . Jante PopJazz Ride	364 . 808
		171 . JazzTom3	Crash1	299 . Jante Jazz Ride	365 . 909
		172 . 808	236 . 808	300 . 808	366 . Charleston Songo Fermer
		173 . 909	237 . 909	301 . 909	367 . Charleston standard
		174 . Songo Tom3	238 . Songo Crash1 Jante 239 .	302 . Jante Songo Ride	368 . Charleston Acoustique Fermer
		175 . Tome 3 standard	Jante Crash1 standard	303 . Jante de conduite standard	369 . Seesion Charleston Fermer
		176 . Tom3 acoustique	240 . Jante acoustique Crash1	304 . Jante acoustique	370 . Charleston moderne
		177 . Séance Tom3	241 . Jante Seesion Crash1	305 . Jante Seesion Ride	371 . Charleston Blues Fermer
		178 . Tom3 moderne	242 . Jante Crash1 moderne	306 . Jante de conduite moderne	372 . Charleston classique
		179 . BluesTom3	243 . Jante Blues Crash1	307 . Jante Blues Ride	373 . Synthgaze Charleston Fermer
		180 . Classique Tom3	244 . Jante Crash1 classique	308 . Jante Classic Ride	374 . Freak Charleston Fermer
		181 . Synthgaze Tom3	245 . Synthgaze Crash1 Jante 246 . Jante	309 . Jante Synthgaze Ride	375 . Baguettes Hi-Hat Fermer
		182 . Monstre Tom3	Freak Crash1	310 . Jante Freak Ride	376 . Charleston Grunge Fermer
		183 . Bâtons Tom3	247 . Bâtons Crash1 Jante	311 . Jante Sticks Ride	377 . Charleston des années 70
		184 . Tom3 grunge	248 . Jante Grunge Crash1 249 .	312 . Jante de tour grunge	378 . Charleston des années 80
		185 . Tom3 des années 70	Jante Crash1 des années 70	313 . Jante Ride des années 70	379 . Charleston populaire
		186 . Tom3 des années 80	250 . Jante Crash1 des années 80	314 . Jante Ride des années 80	380 . Slam Charleston Fermer
		187 . Populaire Tom3	251 . Jante Crash1 populaire 252.	315 . Jante de balade populaire	381 . Attaque Hi-Hat Fermer
		188 . Claquer Tom3	Jante Slam Crash1	316 . Jante Slam Ride	382 . Vieille charley
		189 . Attaque Tom3	253 . Attaque Crash1 Jante	317 . Jante Attack Ride	383 . Fairfax Charleston Fermer
		190 . Vieux Tom3	254 . Ancienne jante Crash1	318 . Ancienne jante Ride	384 . Charleston militaire Fermer 385 .
		191 . Fairfax Tom3	255 . Jante Fairfax Crash1	319 . Jante Fairfax Ride	Pédale de charleston pop
		192 . Militaire Tom3	256 . Jante militaire Crash1	320 . Jante militaire	386 . Putain de pédale de charleston
		Accident .	Monter .	Salut chapeau.	387 . Pédale de charleston rigide
		193 . Pop-Crash1	257 . Promenade pop	321 . Pop charleston ouvert	388 . Pédale de charleston originale
		194 . Putain de Crash1	258 . Putain de tour	322 . Putain de charleston ouvert	389 . Pédale de charleston PopRock
		195 . Crash dur1	259 . Tour difficile	323 . Charleston rigide ouvert	390 . Pédale de charleston Rock
		196 . Crash1 133 d'origine 197 .	260 . Balade originale 261.	324 . Charleston original ouvert	391 . Pédale de charleston en métal
		Crash PopRock1	Balade pop-rock	325 . PopRock charleston ouvert	392 . Pédale de charleston PowerMetal
		PopRock Tom2			393 . Pédale de charleston SpeedMetal 394 .
					Pédale de charleston PopJazz
					395 . Pédale de charleston Jazz
					396 . 808
					397 . 909
					398 . Pédale de charleston Songo
					399 . Pédale de charleston standard



## APPENDIX

400 . Pédale de charleston acoustique		433 . Crash de session2	450 . Baiser la jante Crash2	467 . Jante Blues Crash2
401 . Pédale de charleston Seesion	417 . Pop-Crash2	434 . Crash moderne2	451 . Jante Hard Crash2	468 . Jante Crash2 classique
402 . Pédale de charleston moderne	418 . Putain de Crash2	435 . BluesCrash2	452 . Jante Crash2 d'origine	469 . Jante Synthgaze Crash2
403 . Pédale de charleston Blues	419 . Crash dur2	436 . Crash2 classique	453 . PopRock Crash2 Rime	470 . Jante Freak Crash2
404 . Pédale de charleston classique	420 . Crash2 d'origine	437 . Synthgaze Crash2	454 . Jante Rock Crash2	471 . Bâtons Crash2 Jante
405 . Synthgaze Pédale de Charleston	421 . PopRock Crash2	438 . Crash bizarre2	455 . Jante Metal Crash2	472 . Jante Grunge Crash2
406 . Pédale de charleston Freak	422 . Crash de roche2	439 . Bâtons Crash2	456 . Jante PowerMetal Crash2	473 . Jante Crash2 des années 70
407 . Bâtons Pédale de Charleston	423 . Crash de métal2	440 . Crash grunge2	457 . Jante SpeedMetal Crash2	474 . Jante Crash2 des années 80
408 . Pédale de charleston grunge	424 . Crash de PowerMetal2	441 . Crash2 des années 70	458 . Jante PopJazz Crash2	475 . Jante Crash2 populaire
409 . Pédale de charleston 410	425 . Crash de métal rapide2	442 . Crash2 des années 80	459 . Jante Jazz Crash2	476 . Jante Slam Crash2
des années 70. Pédale de	426 . PopJazz Crash2	443 . Crash2 populaire	460 . 808	477 . Attaque Crash2 Jante
charleston des années 80 411. Pédale	427 . JazzCrash2	444 . Siam Crash2	461 . 909	478 . Ancienne jante Crash2
de charleston populaire 412. Pédale	428 . 808	445 . Attaque Crash2	462 . Jante Songo Crash2	479 . Jante Fairfax Crash2
Slam Charleston 413 . Pédale de	429 . 909	446 . Vieux Crash2	463 . Jante Crash2 standard	480 . Jante militaire Crash2
charleston d'attaque 414 .	430 . Songo Crash2	447 . Crash de Fairfax2	464 . Jante acoustique Crash2	
Ancienne pédale de charleston 415 .	431 . Crash standard2	448 . Crash militaire2	465 . Jante Seesion Crash2	
Pédale de charleston Fairfax 416 . Pédale de charleston militaire	432 . Crash acoustique2	449 . Jante Pop Crash2	466 . Jante Crash2 moderne	
Accident 2				

## Drum combination timbre

01 Pop	09 VitesseMétal
02 Putain	dixPopJazz
03 Difficile	11Jazz
04 Originale	12 808
05 Pop-Rock	13 909
06 Rocher	14Songo
07 Métal	15 Norme
08 PowerMétal	16 Acoustique

## User drum group

17ème séance	25 années 70
18 Moderne	26 années 80
19 Bleus	27 Populaire
20 Classique	28 Claquement
21 Regard de synthèse	29 Attaque
22 monstre	30 ans
23 bâtons	31 Fairfax
24 Grunge	32 militaires

## Demonstration music

Chanson 001	Chanson 007	Chanson 013	Chanson 019	Chanson 025
Chanson 002	Chanson 008	Chanson 014	Chanson 020	Chanson 026
Chanson 003	Chanson 009	Chanson 015	Chanson 021	Chanson 027
Chanson 004	Chanson 010	Chanson 016	Chanson 022	Chanson 028
Chanson 005	Chanson 011	Chanson 017	Chanson 023	Chanson 029
Chanson 006	Chanson 012	Chanson 018	Chanson 024	Chanson 030



## ENTRETIEN DU PRODUIT

Un entretien et une protection minutieux de ce produit jouent un rôle très important dans la prolongation de la durée de vie du produit et la réduction des défauts.

### 1 Évitez la chaleur, l'humidité ou la lumière directe du soleil

N'exposez pas trop le produit à la lumière directe du soleil et ne le placez pas à proximité du climatiseur ou d'un endroit extrêmement chaud.

### 2 Ne pas utiliser à proximité d'une télévision ou d'une radio

Ce produit peut provoquer des interférences vidéo ou audio avec la réception de la télévision et de la radio. Si cela se produit, retirez le produit du téléviseur ou de la radio.



## ENTRETIEN DU PRODUIT

### 3 N'utilisez pas de peinture, de diluant ou de produits chimiques similaires pour le nettoyage

Veillez utiliser un chiffon de nettoyage doux et sans saleté trempé dans une petite quantité d'eau ou un détergent spécial pour nettoyer les taches de surface de ce produit.

### 4 Ne secouez pas pour éviter les collisions

Le produit doit être manipulé avec précaution lors du déplacement. Les vibrations violentes et les collisions sont strictement interdites pour éviter d'endommager la coque ou les composants électroniques internes.



## SAFETY PRECAUTIONS

### POWER SUPPLY

This product can be powered by standard indoor wall sockets. Please only use the power cord specified in this product. When not in use, please turn off the power supply. When not in use for a long time, pull out the power cord and keep it properly.

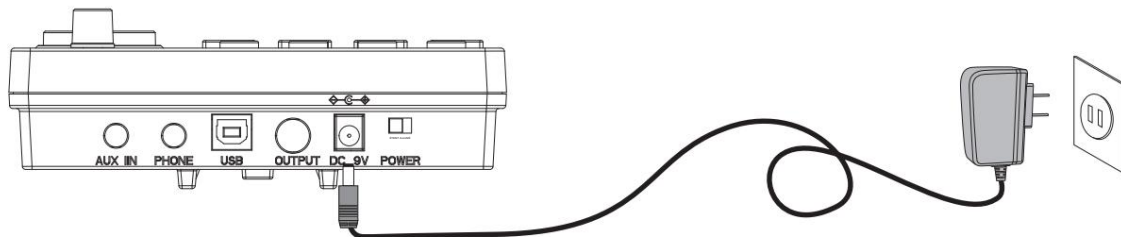

### SIGN

To ensure that you use this product safely and correctly, to prevent harm to users and others and financial damage, this manual and products are marked with a series of safety signs. The various signs and their meanings are as follows:

#### **WARNING**

This sign indicates that there is a potential risk of death or serious injury if this mark is ignored and the product is mishandled.

#### **BE CAREFUL**

This sign indicates that there is a potential danger of injury to personnel or other financial damage if this sign is ignored and the product is operated incorrectly.

### EXAMPLE OF LOGO



This triangle sign ( $\Delta$ ) indicates what users should pay attention to. (The left example is careful shocks)



A circular sign ( $\ominus$ ) with an oblique line indicates prohibitions. The icons in or beside the logo indicate the contents specifically prohibited. (The example on the left is no disassembly)



The round black bottom sign ( $\oplus$ ) indicates what must be observed. The diagrams in this sign indicate the contents of the specific matters that must be observed. (The example on the left is that the power plug must be pulled out of the socket)



## SAFETY PRECAUTIONS

### **WARNING**

#### **Smoke, odor, overheating**

When the product smokes, smells or overheats, there is a danger of fire and electric shock when it is used continually. In case of the above situation, the following operations should be performed immediately:

1. Turn off the power supply.
2. Pull the plug out of the power outlet.
3. Contact your dealer.

#### **Power cord**

1. The improper use of power cord may cause fire and electric shock. The following precautions must be observed:
  - The special power cord designated for this product must be used.
  - The AC power supply with output voltage within the rated voltage range for household use must be used.
  - Do not overload power sockets and extension lines.
2. The improper treatment of power line will lead to its damage or breakage, which will cause fire and electric shock hazards. The following precautions must be observed:
  - Do not place or heat heavy objects on power lines.
  - Do not attempt to alter or bend the power cord too much.
  - Do not twist or pull the power cord.
  - If the power cord or plug is damaged, please replace the same type of power cord.
3. Do not touch the power cord and plug with wet hands, otherwise there is a danger of electric shock.
4. Please use the power cord where the water will not splash. Water is in danger of causing fire and electric shock.
5. Never place vases or any other container containing water on this product. Water is dangerous of causing fire and electric shock.
6. Do not allow minors to unplug and touch power lines or connection boards. Minors have no common sense of electricity safety, which may cause electric shock.

### **BE CAREFUL**

The improper use of power cord may cause fire and electric shock. The following precautions must be observed:

- Never put the power cord near the oven or other heat source.
- Do not pull the cable when pulling out of the power socket. The main body of the plug must be grasped.
- The power cord plug must be inserted in the socket to the end.
- Make sure the power supply is off before connecting or disconnecting it.
- When thunderstorms occur or before traveling or other long-term departure, disconnect the power cord from the wall outlet.
- At least once a year, remove the power cord from the wall outlet and clean the dust accumulated around the plug.

#### **Do not burn this product**

Do not put this product in the fire, otherwise it will lead to product combustion and explosion of internal electronic components, which will cause fire and personnel injury.

#### **Water and foreign bodies**

Water, other liquids and (metal sheets, etc.) entering this product are in danger of causing fire and electric shock. In case of the above situation, the following operations shall be performed immediately:

1. Turn off the power supply.
2. If you are using a power cord for power supply, unplug it from the wall outlet.
3. Contact your distributor.

#### **Disassembly and transformation**

Do not disassemble or transform the product in any way, otherwise there is a risk of electric shock, scald or other personal injury. All internal inspection, adjustment and maintenance operations should be entrusted to your distributor.



## SAFETY PRECAUTIONS

### Falling or colliding

If the product falls or is damaged by strong impact, it will be in danger of causing fire and electric shock. In case of the above situation, the following operations shall be performed immediately:

1. Turn off the power supply.
2. If you are using a power cord for power supply, you need to unplug it from the wall outlet.
3. Contact your distributor.



### Plastic bag

Do not let anyone put plastic bags for this product on his head or in his mouth. Otherwise, there is a risk of asphyxia. Families with young children should pay special attention to it.



### Keep a distance from the product and the bracket

Climbing the bracket is dangerous of overturning or damage. Families with young children should pay special attention to it.



### Put

Avoid placing the product on an uneven surface or any other unstable place. Otherwise, it will cause the product to fall down, which will lead to the risk of injury.



### Product Mobility

Before moving this product, you must unplug the power cord plug from the wall outlet and pull out all other cables and connecting wires. Otherwise, it will lead to damage of power or connection wires, resulting in fire and electric shock.



### clean

Before cleaning this product, you must unplug the power cord plug from the wall outlet, otherwise there is a risk of fire and electric shock.



### Jack

The socket of this product can only be connected to the designated equipment and devices. Connecting non-designated equipment or devices is dangerous of causing fire and electric shock.



### Location selection

It should be avoided to place the product in the following places, otherwise there is a risk of fire and electric shock.



- High temperature or dusty places.
- Kitchen or other places with lampblack.
- Where the product is exposed to direct sunlight, or any other place where the product will produce high temperature.

### Volume

Don't play music long and loud. Pay special attention when using headphones. Excessive volume can damage your hearing.



### Heavy



Do not place heavy objects on this product. Otherwise, the top of the product will be overweight, causing the product to overturn or drop objects on it, which will lead to the risk of injury.



### Correct assembly of scaffolds

The incorrect assembly of the bracket may overturn, causing the product to fall off and posing a risk of injury to personnel. Therefore, it must be assembled according to the instructions in the attached installation guide to ensure that the product is properly mounted on its bracket.



	<p>Avertissement : Pour réduire le risque de blessure, l'utilisateur doit lire attentivement le manuel d'instructions.</p>
	<p>Cet appareil est conforme à la partie 15 des règles FCC. Son fonctionnement est soumis aux deux conditions suivantes : (1) Cet appareil ne doit pas provoquer d'interférences nuisibles et (2) cet appareil doit accepter toute interférence reçue, y compris les interférences susceptibles de provoquer un fonctionnement indésirable.</p>
	<p>Ce produit est soumis aux dispositions de la directive européenne 2012/19/CE. Le symbole représentant une poubelle barrée indique que le produit nécessite une collecte sélective des déchets dans l'Union européenne. Ceci s'applique au produit et à tous les accessoires marqués de ce symbole. Les produits marqués comme tels ne peuvent pas être jetés avec les ordures ménagères normales, mais doivent être déposés dans un point de collecte pour le recyclage des appareils électriques et électroniques.</p>

Fabricant : Shanghaimuxinmuyeyouxiangongsi Adresse :

Shuangchenglu 803nong11hao1602A-1609shi, baoshanqu, shanghai 200000 CN.

Importé en Australie : SIHAO PTY LTD, 1 ROKEVA STREETESTWOOD NSW  
2122 Australie

Importé aux États-Unis : Sanven Technology Ltd., Suite 250, 9166 Anaheim Place, Rancho  
Cucamonga, CA 91730

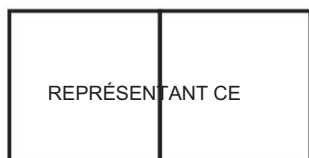

E-CrossStu GmbH  
Mainzer Landstr.69, 60329 Francfort-sur-le-Main.



YH CONSULTING LIMITÉE.  
C/O YH Consulting Limited Bureau 147, Centurion House,  
London Road, Staines-upon-Thames, Surrey, TW18 4AX



**VEVOR<sup>®</sup>**

**TOUGH TOOLS, HALF PRICE**

Assistance technique et certificat de garantie  
électronique [www.vevor.com/support](http://www.vevor.com/support)

# VEVOR®

## TOUGH TOOLS, HALF PRICE

Technischer Support und E-Garantie-Zertifikat  
[www.vevor.com/support](http://www.vevor.com/support)

### ELEKTRONISCHES SCHLAGZEUG

### BENUTZERHANDBUCH

MODELL: MD200F-P

Wir sind weiterhin bestrebt, Ihnen Werkzeuge zu wettbewerbsfähigen Preisen anzubieten. „Sparen Sie die Hälfte“, „Halber Preis“ oder andere ähnliche Ausdrücke, die wir verwenden, stellen lediglich eine Schätzung der Ersparnis dar, die Sie beim Kauf bestimmter Werkzeuge bei uns im Vergleich zu den großen Topmarken erzielen können, und decken nicht unbedingt alle von uns angebotenen Werkzeugkategorien ab. Wir möchten Sie freundlich daran erinnern, bei der Bestellung bei uns sorgfältig zu prüfen, ob Sie im Vergleich zu den großen Topmarken tatsächlich die Hälfte sparen.

# VEVOR<sup>®</sup>

TOUGH TOOLS, HALF PRICE

ELEKTRONISCHES SCHLAGZEUG

MODELL: MD200F-P F

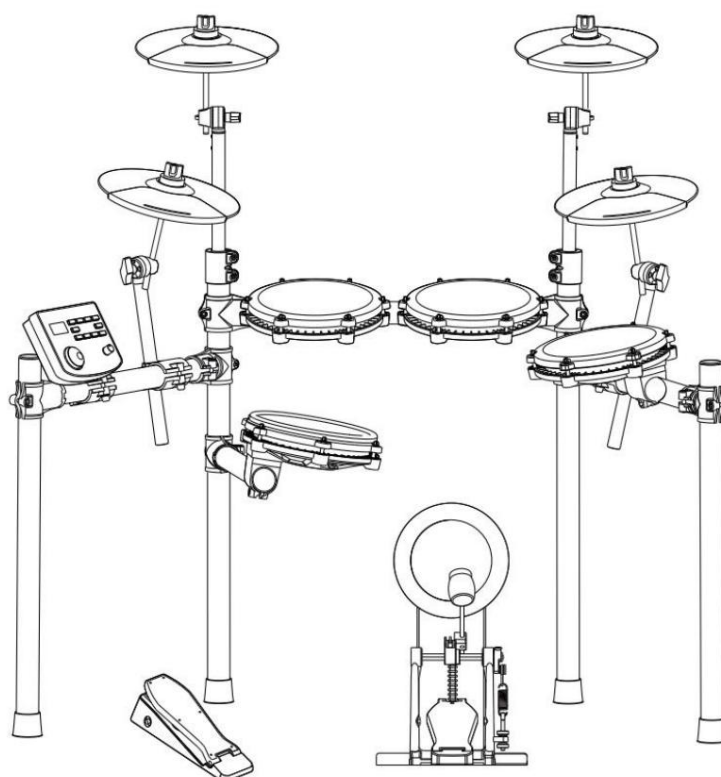

(Das Bild dient nur als Referenz, bitte beziehen Sie sich auf das tatsächliche Objekt )

## Brauchen Sie Hilfe? Kontaktieren Sie uns!

Haben Sie Fragen zu unseren Produkten? Benötigen Sie technische Unterstützung?  
Kontaktieren

Sie uns: **Technischer Support und E-Garantie-Zertifikat**

**[www.vevor.com/support](http://www.vevor.com/support)**

Dies ist die Originalanleitung. Bitte lesen Sie alle Anweisungen sorgfältig durch, bevor Sie das Gerät in Betrieb nehmen. VEVOR behält sich eine klare Auslegung unserer Bedienungsanleitung vor. Das Erscheinungsbild des Produkts richtet sich nach dem Produkt, das Sie erhalten haben. Bitte verzeihen Sie uns, dass wir Sie nicht erneut informieren, wenn es Technologie- oder Software-Updates für unser Produkt gibt.



## FUNKTION EINFÜHRUNG

Vielen Dank, dass Sie sich für unser elektronisches Schlagzeug entschieden haben. Das elegante und filigrane elektronische Schlagzeug ist die perfekte Kombination aus moderner neuer elektronischer Technologie. •Bevor Sie dieses Produkt verwenden, müssen Sie die Anweisungen ausführlich lesen.

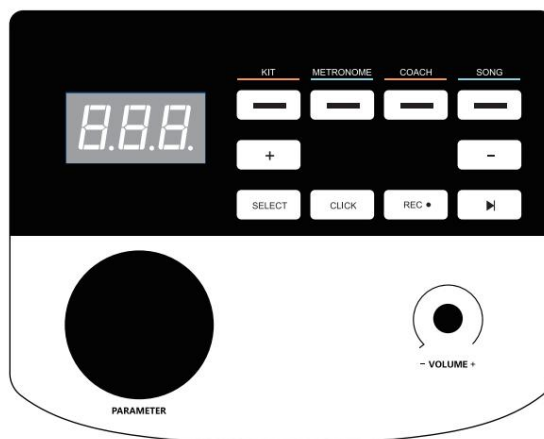

- 32 Schlagzeugsätze, 480 Klangfarben
- 30 Lieder
- Unterstützt die Anpassung der Empfindlichkeitsparameter jeder Trommel
- Drei Unterrichtsmodi
- Geschwindigkeitsregelung: 30 ~ 250 Schläge/min
- Metronom: 1-9 Typen
- Weitere Funktionen: Parameterspeicherung, -rücksetzung und -aufzeichnung;
- dreistellige LED-Anzeige;
- Schnittstelle: Stromversorgung DC, USBMIDI, Kopfhörer, Audioeingang, Audioausgang

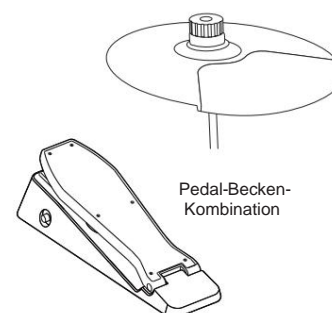
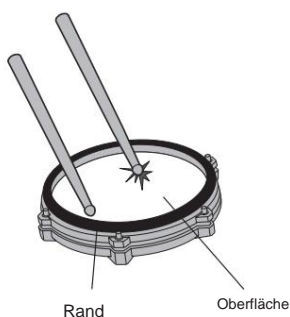

### ANMERKUNG!

- Bei diesem Produkt handelt es sich um ein elektroakustisches Instrument. Es ist normal, dass nach dem Einschalten ein leises Stromgeräusch im Lautsprecher oder Kopfhörer zu hören ist.  
Halten Sie das Gerät während der Verwendung von „Radio, Fernseher, Antennenempfänger, Router, Kühlschrank, Fernsehgerät, Motor und anderen elektrischen HF-Störquellen“ fern.



# INHALT

<b>FUNKTION EINFÜHRUNG</b>	<b>1</b>
<b>INHALT</b>	<b>2</b>
<b>INSTALLATIONSANLEITUNG</b>	<b>3</b>
ÜBERPRÜFEN SIE DIE BEILIEGENDEN ELEMENTE	3
LRON-ROHRHALTER	4
TROMMELINTUBATION	4
MONTAGESTÄNDER	5
INSTALLATION DES DRUM-MODULS	5
SCHLAGTEILE UND SOUNDMODUL INSTALLIEREN	6
INSTALLIEREN DER KICK DRUM	7
MONTAGE DER HAMMERSTAB	7
DIE KICK DRUM WIRD MIT DEM STEP HAMMER FESTGEHALTEN	7
SCHLAGTEIL-ANSCHLUSSKABEL EINSTECKEN	7
<b>ABBILDUNG DES SOUNDMODUL-PORTS</b>	<b>8</b>
ANSCHLUSS DES NETZKABELS	8
USB-MIDI-ANSCHLUSS	8
AUDIO-AUSGANGSANSCHLUSS	8
AUDIO-EINGANGSANSCHLUSS	8
KOPFHÖRERANSCHLUSS	8
PORT ERHÖHEN	8
BT-MODUS	8
<b>BEDIENUNGSANLEITUNG</b>	<b>9</b>
LEISTUNG	9
SCHLAGZEUGAUSWAHL	9
METRONOM	9
PRAXISFUNKTION	9
COACH-MODUS	9
DEMO-SONGS	10
TROMMELPARAMETER	10
AUFNAHMEFUNKTION	10
SPEICHERN / ZURÜCKSETZEN	10
USB-MIDI	11
<b>ANHANG</b>	<b>11</b>
TIMBRE	11
VOREINGESTELLTE DRUM-KITS	11
BENUTZERDEFINIERT DRUM-KITS	11
DEMO STRATIONSSONG	11
<b>PRODUKTWARTUNG</b>	<b>12</b>
<b>SICHERHEITSVORKEHRUNGEN</b>	<b>13</b>



# INSTALLATIONSANLEITUNG

## ANMERKUNG!

- Bitte befolgen Sie die Anweisungen und lesen Sie die „Sicherheitshinweise“ im Benutzerhandbuch sorgfältig durch vor Gebrauch .
- Dieses Produkt muss von einem Erwachsenen installiert werden. Überlassen Sie die Installation bitte nicht Minderjährigen.

# 01

## Überprüfen Sie die beigelegten Elemente

- Bitte prüfen Sie nach dem Öffnen der Verpackung umgehend, ob diese vollständig ist. Bei Unvollständigkeiten wenden Sie sich bitte an Ihren Händler.



Soundmodul



Modulhalterung



Becken \*4

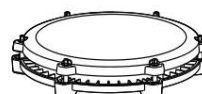

Tom (3 Stück)



Schlinge



Hinterne Halterung



Verbindungshalterung



Vordere Halterung



Trete

2 STK 2 STK 6 STK



schrauben

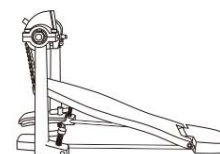

Fußmaschine



Beckenarm  
(4 Stück)



Hi-Hat-Pedal



Bolzentreiber



Signalanschlusskabel

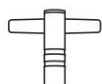

Stimmlüssel



Netzteil



Trommelstock



Stielhammer



## MONTAGEZEICHNUNG

### 02

#### Rohrhalter aus Eisen

•Der Ständer befindet sich in einer kleinen Einzelverpackung im Inneren der Box.

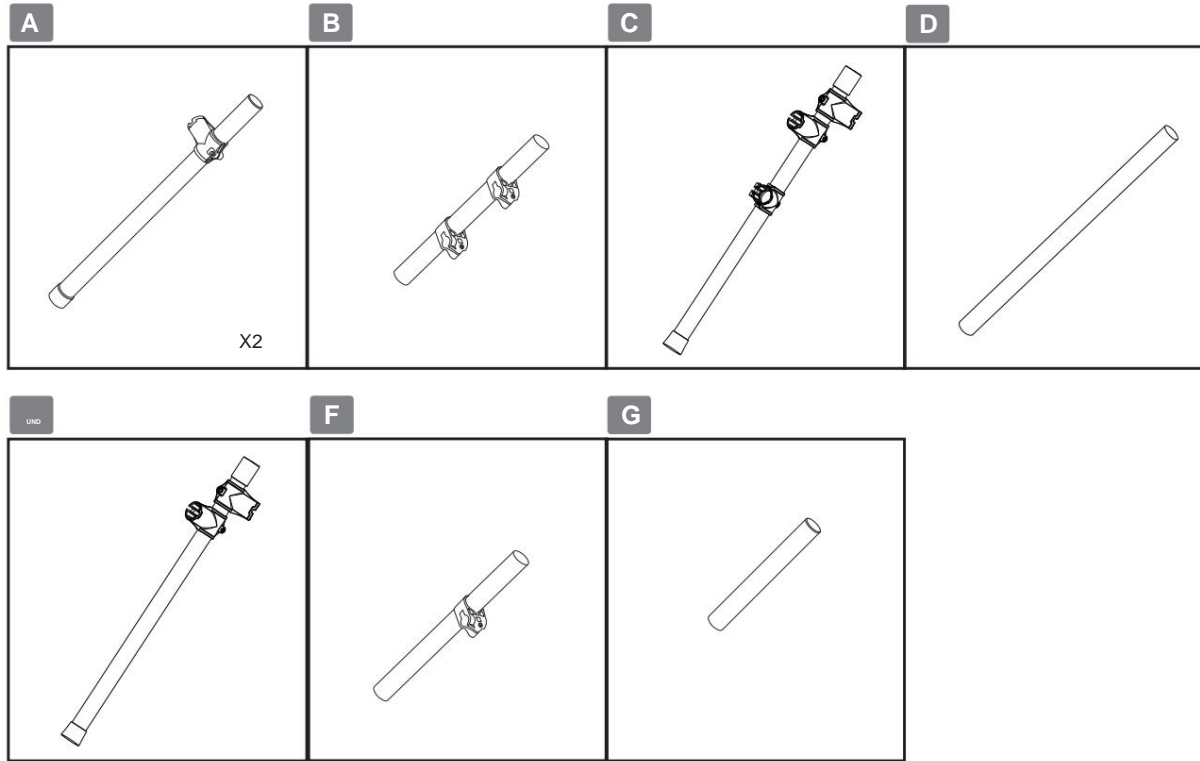

### 03 Trommelfellintubation

Montieren Sie die Trommel auf der Trommelstützstange.

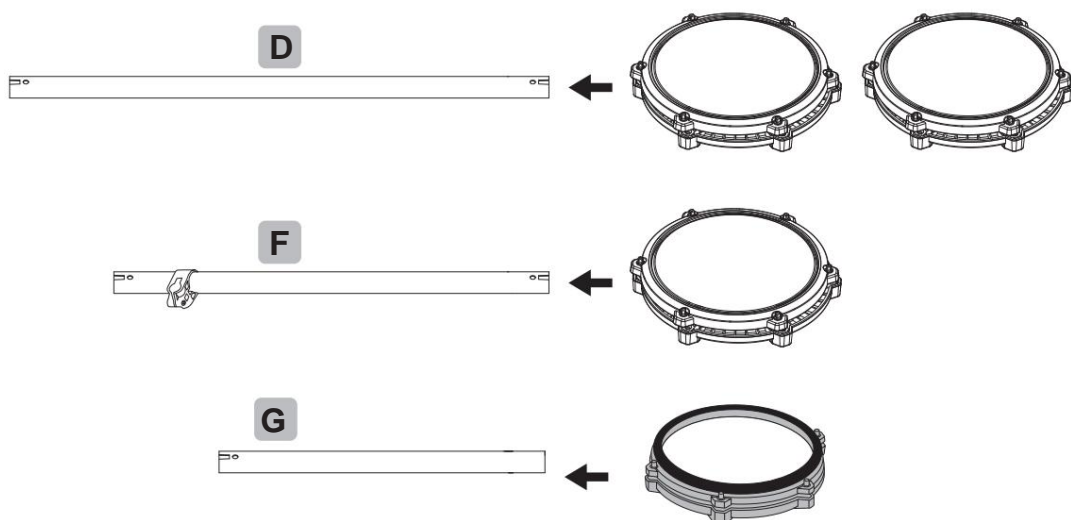



## INSTALLATIONSANLEITUNG

### 04

### Montagegeständer

- Ziehen Sie während der Installation die Schrauben fest und seien Sie vorsichtig, damit Sie sich nicht die Finger einklemmen.
- Montieren Sie die Halterung in der angegebenen Richtung

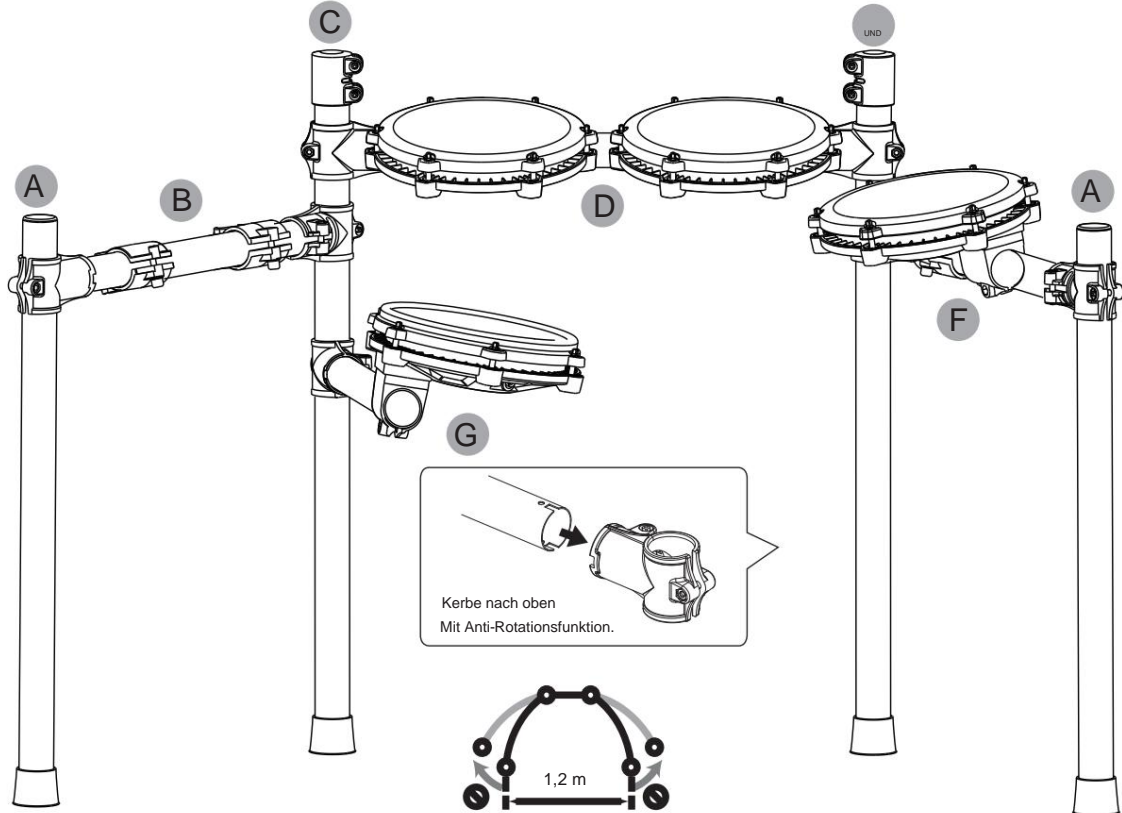

Aus Sicherheitsgründen sollte die Ausdehnungsbreite der Stütze nicht größer als 1,2 Meter sein.

### 05

### Installieren des Drum-Moduls

- Bitte setzen Sie es während der Installation an der richtigen Stelle ein.

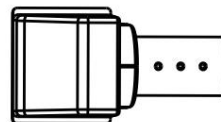
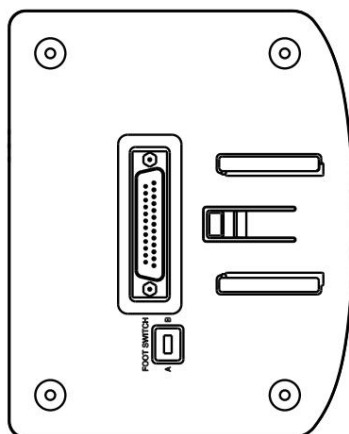

Richten Sie das Mainframe-Drummodul an der Mainframe-Boxschiene aus und setzen Sie es ein. Nachdem Sie es bis zum Boden eingeschoben haben, können Sie hören, wie die Schnappstücke hochspringen.



06

## Schlagteile und Soundmodul einbauen

- Ziehen Sie die Schrauben nach dem Einsetzen der Trommel fest, um ein Lösen zu vermeiden.
- Achten Sie darauf, das Becken nicht zu fest anzuziehen; lassen Sie etwas Spielraum, damit sich das Becken auf und ab bewegen kann.

Die Muttern und Ringpolster der drei Beckenarme lösen, die drei Becken in die entsprechenden Arme stecken und die Muttern anschrauben. 3 Becken bzw. 1 Trommel in die entsprechenden Stützstangen stecken und die Schrauben festziehen.  
Hinweis: Die Funktionen der einzelnen Becken, Toms und Snaredrums sind unterschiedlich, daher ist für die korrekte Installation die Zubehörentifikation zu beachten!

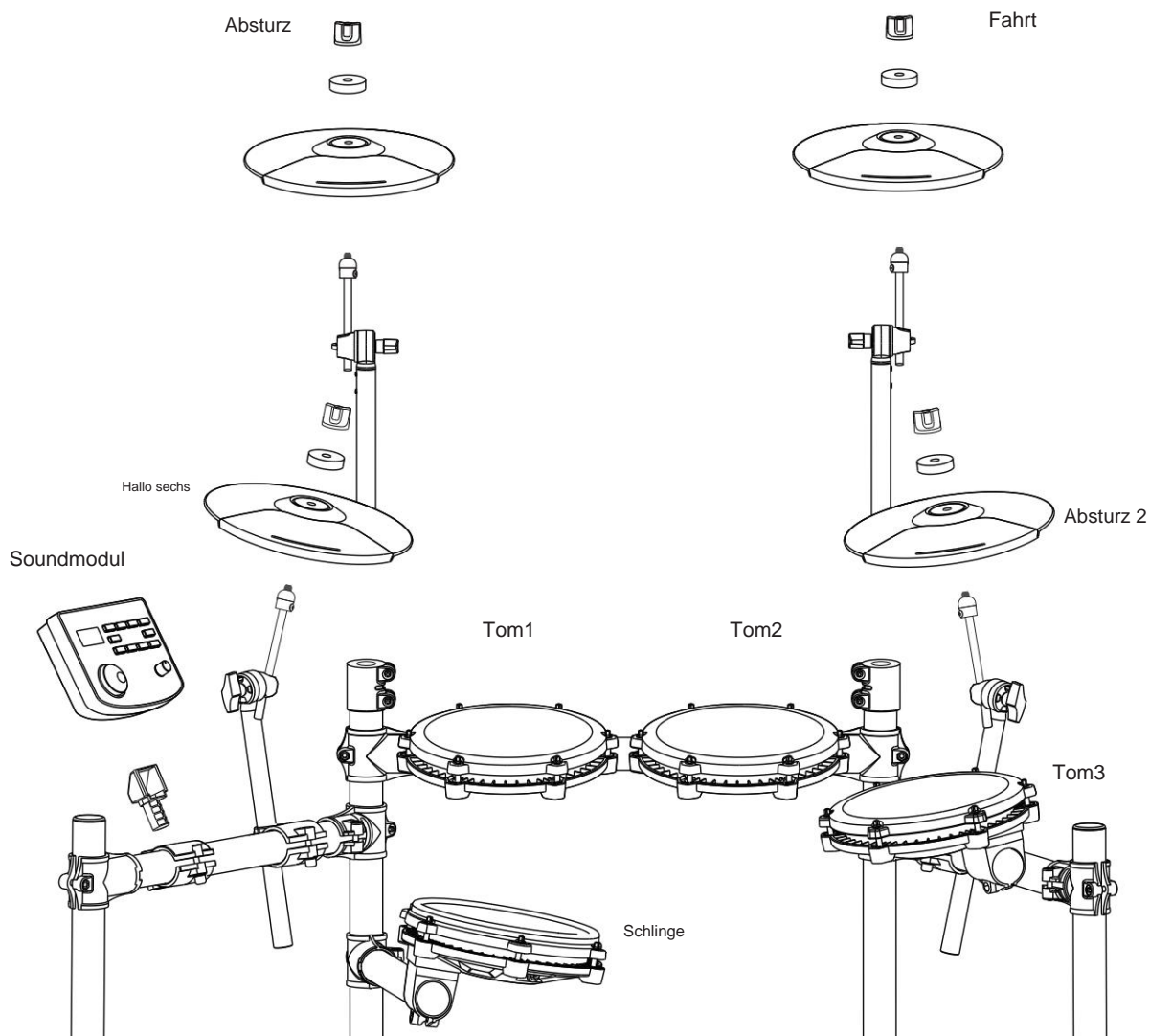



## INSTALLATIONSANLEITUNG

# 07

### Installieren Sie die Kick-Drum

- Ziehen Sie beim Einbau die Schrauben bitte fest und achten Sie darauf, sich nicht die Finger einzuklemmen.

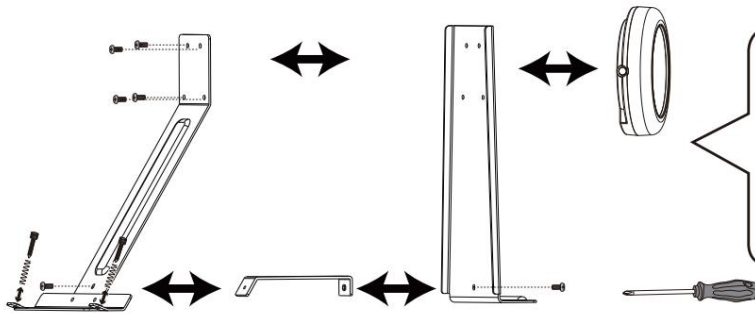

Befestigen Sie die untere Trommel mit einem Schraubendreher, Befestigungen wie gezeigt, Stützteile mit 6 kleinen Schrauben. Stecken Sie dann zwei Federn in zwei Anti-Rutsch-Schrauben und verriegeln Sie die beiden Federn an der Unterseite des Stützstücks, bis es auf dem Boden aufliegt.

# 08

### Installieren Sie die Hammerstange

- die Stange sollte in Spitze eingefügt werden und die Schrauben sollten festgezogen werden, um ein Lösen zu verhindern.

Stecken Sie die Hammerstange in das runde Loch wie in der Abbildung gezeigt, drehen Sie den Wollhammer, um ihn mit der Trommeloberfläche auszurichten, und anschließend mit dem Stimmschlüssel festziehen.

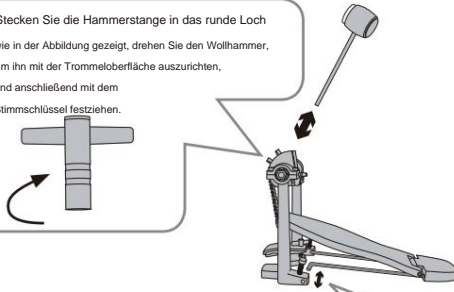

Stecken Sie die feste Eisenstange in das Loch wie in der Abbildung gezeigt.

# 09

### Die Kick Drum wird mit der Stufenhammer

- Die untere Trommel und der Stufenhammer sollten befestigt sein und festgezogen, um ein Herunterfallen zu verhindern.

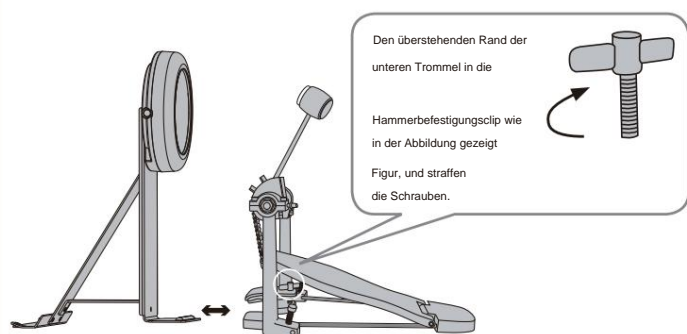

Den überstehenden Rand der unteren Trommel in die Hammerbefestigungsclip wie in der Abbildung gezeigt Figur, und straffen die Schrauben.

# 10

### Schlagteil-Anschlusskabel einstecken

- Bitte stecken Sie das Verbindungskabel an der richtigen Stelle ein, um einen schlechten Kontakt zu vermeiden, und stecken Sie es korrekt ein, wie in der Abbildung gezeigt.

Bitte überprüfen Sie, ob die untere Trommel Geräusche macht.

Wenn kein Geräusch zu hören ist, schalten Sie bitte den Schalter ein:

Schalter in A: mechanischer Kick-Drum-Modus

Schalter in B: Pedalmodus.

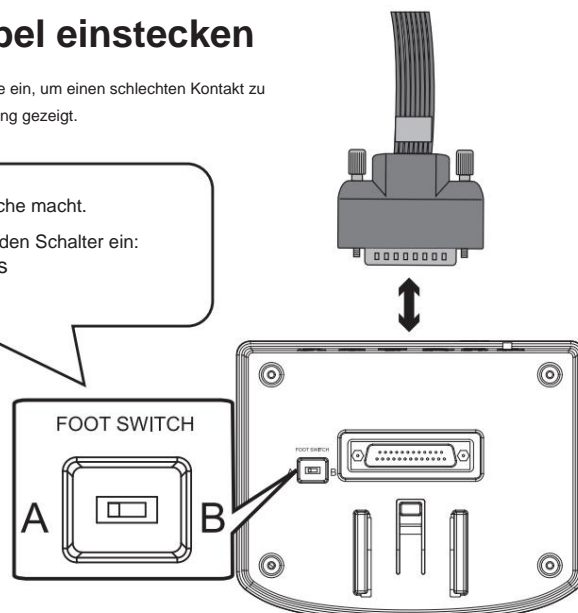



## ABBILDUNG DES SOUNDMODUL-PORTS

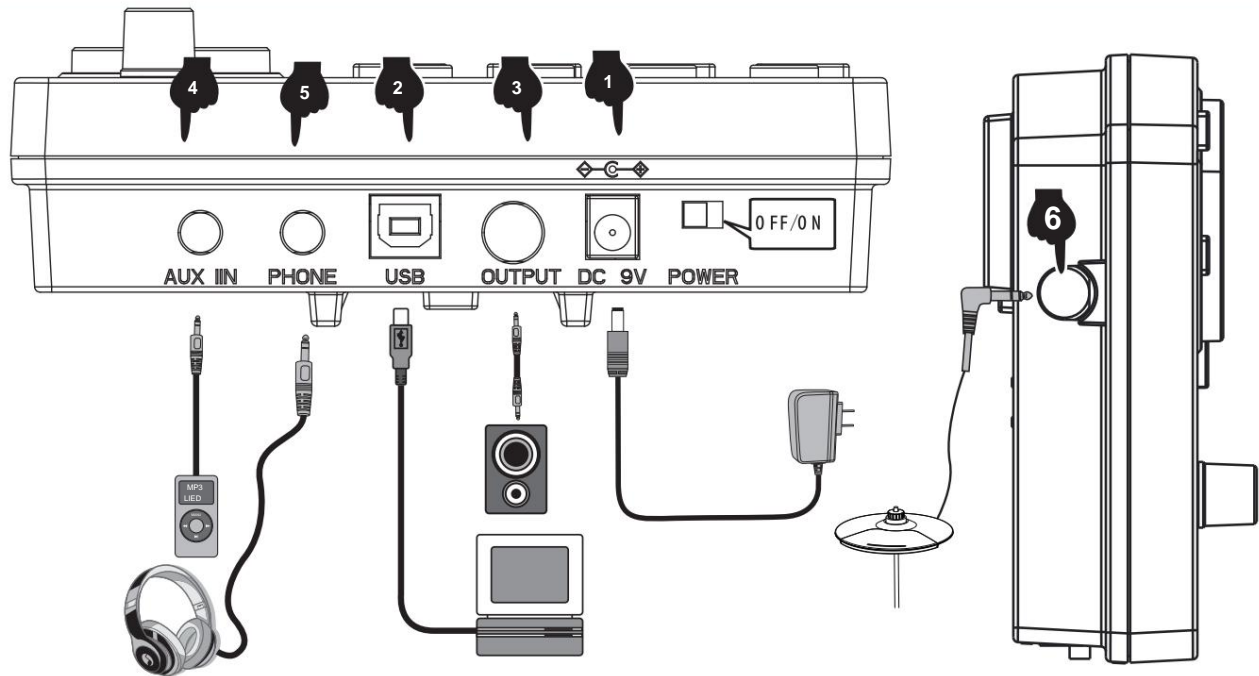

### 1 NETZKABELANSCHLUSS

1. Bei Gebrauch schließen Sie die Stromklemme gemäß dem Diagramm an und stecken Sie sie in die Steckdose des Soundmoduls. an einem Ende und einer 100–240V-Haushaltssteckdose am anderen Ende. (Abb. 1)
2. Wenn Sie das Produkt längere Zeit nicht verwenden, ziehen Sie bitte den Netzstecker und bewahren Sie ihn ordnungsgemäß auf.

### 2 USB-MIDI-ANSCHLÜSSE

Durch die Verwendung der MIDI-USB-Schnittstelle für elektronische Drums ist die Interaktion mit Musikgeräten über MIDI möglich.

1. Durch die vorinstallierte Musiksoftware auf Computern und Mobiltelefonen können wir lernen, zu spielen, zu komponieren Musik, Speichern und andere Funktionen. (Abb. 2)
2. Bei Anschluss an einen Computer oder ein Mobiltelefon muss der Audioausgang des Geräts mit der Audioeingangsbuchse der Modulbox verbunden werden, um die Soundeffekte auf dem Gerät zu synchronisieren. (Abb. 5)

### 3 AUDIO-AUSGANG

An den Audioausgang können Aktivlautsprecher (spezieller E-Drum-Lautsprecher) und große Audiogeräte angeschlossen werden. (Abb. 3)

### 4 AUDIO-EINGANG

Über den Audio-Eingangsanschluss kann das Wiedergabegerät der Tonquelle (z. B. MP3, Mobiltelefon) zur Wiedergabe an die Modulbox angeschlossen werden. und andere Audiosignaleingänge). (Abb. 4)

### 5 KOPFHÖRER-ANSCHLUSS

Durch den Anschluss von Kopfhörern können Sie die Details der Perkussion überwachen und andere nicht stören, wenn Sie ohne Anschluss spielen. Lautsprecher. (Abb. 5)

### 6 PORT ERHÖHEN

Über diesen Anschluss können Sie zur einfachen Erweiterung ein Becken hinzufügen. (Abbildung 6)



## BEDIENERFÜHRUNG

### 1 LEISTUNG

Stecken Sie den DC-Stecker in den DC 9V-Anschluss oben auf der Steuereinheit. Schieben Sie den POWER-Schalter nach rechts (von vorne), um das Schlagzeug einzuschalten. Um das Schlagzeug auszuschalten, schieben Sie den Schalter nach links.

### 2 DRUM-KIT-AUSWAHL

Drücken Sie die KIT-Taste, um das aktuelle Drum-Kit anzuzeigen. Drehen Sie das Parameterrad oder verwenden Sie die Tasten <- /+>, um das gewünschte Schlagzeug. Es stehen 32 Schlagzeug-Sets zur Auswahl – siehe Schlagzeug-Set-Liste auf Seite 11.

### 3 METRONOM

1. Drücken Sie die METRONOME-Taste, um in den Metronommodus zu wechseln.
2. Auf dem Bildschirm wird der Geschwindigkeitswert angezeigt (Standardgeschwindigkeit 120 BPM). Drehen Sie das Parameterrad oder verwenden Sie die Tasten +/-, um Ändern Sie die Metronomgeschwindigkeit. Drücken Sie die CLICK-Taste, um das Metronom zu starten.
3. Drücken Sie die SELECT-Taste im Metronommodus, und der Bildschirm springt zur Einstellung der Metronomparameter Schnittstelle. Sie können die Tasten +/- drücken, um den Parameter auszuwählen, den Sie anpassen möchten:
  - A. r (Schlagart: 2,4,8,16)
  - B. b (Schlagzahl: 01-09)
  - C. L (Metronomlautstärke: 00 (aus) -31), und drehen Sie dann das Parameterrad, um die Parametereinstellungen anzupassen.
4. Sobald die Parameter eingestellt wurden, drücken Sie die SELECT-Taste, um zu bestätigen und die Parameteroberfläche zu verlassen. Mit der CLICK-Taste können Sie das Metronom nach Wunsch starten und stoppen.

### 4 PRAXISFUNKTION

Der „Coach“-Trainermodus dieses Produkts kann dabei helfen, Geschwindigkeit, Genauigkeit und Ausdauer aufzubauen und die Übungsfunktion eines besseren Rhythmusgefühls zu entwickeln. Machen Sie unter der Aufsicht des „Coach“-Trainermodus Fortschritte!

Drücken Sie die Taste „Trainer“, um in den Trainermodus zu gelangen. In diesem Modus gibt es drei Übungsmodi. Wählen Sie den Übungsmodus -Modus über das Datenrad oder die Taste <+ > <- >.

1. Übungsmodus 1: C-1-Schlagerkennungsübung: Schlagen Sie die Trommel mit einer festen Geschwindigkeit, um die Genauigkeit des Schlags zu trainieren.
2. Übungsmodus 2: C-2 Silent Strike-Modus: Das Metronom lässt einen Abschnitt erklingen und einen Abschnitt stummschalten, um die Schlaggenauigkeit ohne Metronom-Aufforderung. Es handelt sich um eine erweiterte Version des Übungsmodus 1.
3. Übungsmodus 3: C-3 Geschwindigkeitsschlagübung, das Metronom ändert automatisch die Geschwindigkeit, erhöht vom langsamsten Express zum schnellsten und dann vom langsamsten Express zur langsamsten Geschwindigkeit reduzieren, so um die Schlagausdauer zu trainieren.

### 5 COACH-MODUS

1. Der "Coach"-Trainingsmodus dieses Produkts kann dabei helfen, Geschwindigkeit, Genauigkeit und Ausdauer aufzubauen. Drücken Sie die COACH Taste, um in den Trainermodus zu gelangen. In diesem Modus gibt es drei Übungsmodi. Verwenden Sie das Parameterrad, um auszuwählen welcher Übungsmodus.
  - A. Übungsmodus 1: C-1 Übung zur Schlagerkennung – Schlagen Sie die Trommel mit einer festen Geschwindigkeit, um die Genauigkeit des Schlags zu trainieren.
  - B. Übungsmodus 2: C-2 Stiller Schlagmodus - das Metronom lässt einen Abschnitt erklingen und einen Abschnitt stummschalten, um zu trainieren wenn es keinen Takt gibt.
  - C. Übungsmodus 3:C-3 Geschwindigkeitsschlagübungen - das Metronom ändert automatisch die Geschwindigkeit von der langsamsten zum Schnellsten und dann vom Schnellsten zum Langsamsten.
2. Sobald der Coaching-Modus ausgewählt wurde, drücken Sie die CLICK-Taste. Die Metronomschläge werden gestartet und Sie können Spielen Sie zum Üben auf der Trommel mit.
3. Nach vier vorläufigen Schlägen zeigt das Display:

(zu langsam)



(Gut)



(zu schnell)





## BEDIENERFÜHRUNG

4. Sobald Sie den Coaching-Modus abgeschlossen haben, wird eine Punktzahl von 0-100 angezeigt, die die Genauigkeit bewertet die Übung.

C-1-Modus: Drücken Sie die SELECT-Taste, um zur Parametereinstellungsoberfläche zu gelangen. Sie können die Anzahl der Übungseinheiten Sitzungen nach Bedarf (01-32). Die Anzahl der Übungssitzungen bestimmt die Länge dieser Übung.

C-2-Modus: Drücken Sie die SELECT-Taste, um die Parametereinstellungsoberfläche aufzurufen. Sie können die Anzahl der Übungssitzungen nach Bedarf anpassen (04-32). Die Anzahl der Übungssitzungen bestimmt die Länge dieser Übung.

C-3-Modus: Drücken Sie die SELECT-Taste, um die Parametereinstellungsoberfläche aufzurufen. Sie können die Rate einstellen, mit der die BPM Änderungen (01-09 BPM).

5. Drücken Sie die CLICK-Taste erneut, um den Coach-Modus zu beenden.

### 6 DEMO-SONGS

1. Drücken Sie die SONG-Taste, um in den Demo-Modus zu gelangen. Es stehen 30 Demos zur Auswahl. Auf dem Bildschirm wird das aktuelle Demosongnummer (01 -30).

2. Drücken Sie die Taste < >, um mit der Wiedergabe der Demosongs zu beginnen. Um die Wiedergabe zu stoppen, drücken Sie erneut die Taste < >.

3. Drehen Sie das Parameterrad oder drücken Sie die Tasten +/-, um einen Demosong auszuwählen.

4. Drücken Sie die SELECT-Taste im Song-Modus, um zur Song-Parameter-Einstellungsoberfläche zu gelangen. Sie können den Drum-Sound einschalten oder aus, indem Sie am Parameterrad drehen (der Drum-Sound ist standardmäßig eingeschaltet).

5. Drücken Sie zur Bestätigung und zum Verlassen der Parameteroberfläche die Taste „AUSWAHL“.

### 7 TROMMELPARAMETER

1. Drücken Sie die KIT-Taste und auf dem Display erscheint 01 (Drum-Kit-Nummer). Drücken Sie SELECT, um den Drum-Parameter einzugeben Anpassungsmodus.

2. Tippen Sie auf die Trommel, die Sie anpassen möchten, und drücken Sie dann die Tasten +/-, um den Parameter für die Anpassung auszuwählen. Empfindlichkeit

A. S(01-06). Triggerschwelle t(01 - 32).

Überschreitschwelle c (01 -32)

B. Wiederholter Trigger r(01-32) Trommelkraft

V (01-03). Trommellautstärke L (00 - 31).

3. Ändern Sie die Parameter durch Drehen des Parameterrads und drücken Sie zum Speichern lange auf die - Taste. Der Bildschirm mit der Anzeige SAV zeigt an, dass die Parameteranpassung erfolgreich gespeichert wurde.

4. Um die Trommelparameter auf die Werkseinstellungen zurückzusetzen, drücken Sie lange die Taste +, bis auf dem Bildschirm RES angezeigt wird.

5. BITTE BEACHTEN: Die Parameter für die 3 Tom-Drums können nicht einzeln eingestellt werden.

### 8 AUFNAHMEFUNKTION

1. Drücken Sie die Taste < REC >, wenn die Kontrollleuchte in den Zuständen "KIT" und "CLICK" leuchtet und auf dem Bildschirm die Die Wörter „REC“ blinken atmend und wechseln in den Aufnahmevorbereitungszustand.

2. Tippen Sie auf eine beliebige Trommel und das Metronom ertönt. Zu diesem Zeitpunkt zeigt der Bildschirm "---" im blinkenden Zustand der Atmung an und beginnt mit der Aufnahme.

3. Drücken Sie die Taste < REC > oder < PLAY > erneut. Die Aufnahme stoppt und „A-1“ wird auf dem Bildschirm angezeigt.

4. Drücken Sie < >, um die Wiedergabe der aktuellen Aufnahme zu starten, und drücken Sie erneut, um die Wiedergabe zu stoppen.

5. Wenn Sie ohne Klopfen erneut in den Aufnahmevorbereitungszustand wechseln, wird das zuletzt aufgenommene „A-1“ wiedergegeben.

### 9 SPEICHERN / ZURÜCKSETZEN

1. Um die Parameter zu speichern, drücken Sie lange auf die Taste <->. Auf dem Bildschirm wird SAV angezeigt.

2. Um die Parameter zurückzusetzen, drücken Sie lange auf die Taste <+> und auf dem Bildschirm wird RES res angezeigt.

### 10 USB-MIDI

Um die MID-Funktion des Drum-Kits zu nutzen, stecken Sie ein USB-B-Datenkabel (nicht im Lieferumfang dieses Drum-Kits enthalten) in die Steuereinheit und stellen Sie eine Verbindung zum PC/Smartphone her.

**ANHANG****Timbre****Trete .**

1. Pop-Kick 2.  
Fick-Kick  
3. Harter Tritt  
4. Original Kick 5.  
PopRock Kick 6. Rock  
Kick  
7. Metallkick  
8. PowerMetal Kick  
9. SpeedMetal Kick 10 .  
PopJazz Kick 11 .  
Jazz Kick  
12 . 808  
13. 909  
14. Songo-Kick 15.  
Standard-Kick  
16. Akustischer Kick  
17. Seesion Kick  
18 . Modern Kick  
19. Blues Kick  
20. Klassischer Kick  
21. Synthgaze Kick 22.  
Freak Kick  
23. Stöcke treten  
24. Grunge-Kick 25.  
70er-Kick  
26. 80er Kick  
27. Populärer Kick  
28. Slam Kick  
29. Angriffstritt  
30. Alter Tritt  
31. Fairfax-Tritt  
32. Militärischer Tritt

**Schlinge .**

33. Pop Snare 34.  
Fuck Snare  
35. Harte Schlinge  
36 . Original Snare 37 .  
Pop Rock Snare 38 .  
Rock-Snare  
39. Metall-Schlinge  
40. PowerMetal Snare  
41. SpeedMetal Snare 42.  
PopJazz Snare 43. Jazz  
Snare  
44 . 808  
45. 909  
46. Songo Snare 47.  
Standard-Snare  
48. Akustische Snare  
49. Seesion-Schlinge  
50 . Moderne Snare  
51. Blues-Snare  
52. Klassische Snare  
53. Synthgaze Snare 54.  
Freak Snare  
55. Sticks Snare  
56. Grunge-Snare 57.  
70er-Jahre-Snare  
58. 80er Snare  
59. Beliebte Snare 60.  
Slam Snare  
61. Angriffsschlinge  
62. Alte Schlinge  
63. Fairfax-Schlinge  
64. Militärische Snare  
65. Pop Snare Rim  
66. Scheiß auf den Snare-Rim  
67. Harter Snare-Rand  
68 . Original Snare Rim 69 .  
PopRock Snare Rhythme

70. Rock-Snare-Rim  
71. Snare-Rand aus Metall  
72. PowerMetal Snare-Rand  
73. SpeedMetal Snare-Rand  
74. PopJazz Snare Rim  
75. Jazz-Snare-Rim  
76 . 808  
77 . 909  
78. Songo Snare Rim  
79. Standard-Snare-Rand  
80. Akustischer Snare-Rim  
81. Seesion Snare Rim  
82. Moderner Snare-Rim  
83. Blues Snare-Rand  
84. Klassischer Snare-Rim  
85. Synthgaze Snare Rim  
86. Freak Snare Rim  
87. Sticks Snare Rim  
88. Grunge Snare Rim  
89. 70er Snare-Rim  
90. 80er Snare-Rim  
91. Beliebter Snare-Rim  
92. Slam Snare-Rand  
93. Angriff Snare Rim  
94. Alter Snare-Rand  
95. Fairfax Snare-Rand  
96. Militärischer Snare-Rim

Rock aus der Tom.

97. Pop Tom1  
98. Scheiß auf Tom1  
99. Harter Tom1  
100 . Original Tom1  
101 . PopRock Tom1  
102. Rock Tom1  
103. Metall Tom1  
104 . PowerMetal Tom1  
105. SpeedMetal Tom1  
106. PopJazz Tom1  
107. Jazz Tom1  
108 . 808  
109 . 909  
110. Lied Tom1  
111. Standard Tom1  
112 . Akustik Tom1  
113. Seesion Tom1  
114. Moderner Tom1  
115. Blues Tom1  
116. Klassischer Tom1  
117. Synthgaze Tom1  
118. Freak Tom1  
119. Stöcke Tom1  
120 . Grunge Tom1  
121. 70er Tom1  
122. 80er Tom1  
123. Beliebte Tom1  
124. Slam Tom1  
125. Angriff Tom1  
126. Alter Tom1  
127. Fairfax Tom1  
128. Militärischer Tom1 129.  
Pop-Tom2  
130. Scheiß auf Tom2  
131. Harter Tom2  
132 . Original Tom2  
133 . PopRock Tom2

134. Rock Tom2  
135. Metall Tom2  
136. PowerMetal Tom2  
137. SpeedMetal Tom2 138.  
PopJazz Tom2  
139. Jazz Tom2  
140 . 808  
141 . 909  
142. Lied Tom2  
143. Standard Tom2  
144 . Akustik Tom2  
145. Seesion Tom2  
146. Moderner Tom2  
147. Blues Tom2  
148. Klassischer Tom2  
149. Synthgaze Tom2  
150. Freak Tom2  
151. Stöcke Tom2  
152. Grunge Tom2  
153. 70er Tom2  
154. 80er Tom2  
155. Beliebte Tom2  
156. Slam Tom2  
157. Angriff Tom2  
158. Alter Tom2  
159. Fairfax Tom2  
160 . Militärischer Tom2 161 .  
Pop-Tom3  
162. Fick Tom3  
163. Harter Tom3  
164 . Original Tom3  
165 . PopRock Tom3  
166. Rock Tom3  
167. Metall Tom3  
168 . PowerMetal Tom3  
169 . SpeedMetal Tom3 170 .  
PopJazz Tom3  
171. Jazz Tom3  
172 . 808  
173. 909  
174. Songo Tom3  
175. Standard Tom3  
176 . Akustik Tom3  
177. Seesion Tom3  
178. Moderner Tom3  
179. Blues Tom3  
180. Klassischer Tom3  
181. Synthgaze Tom3  
182. Freak Tom3  
183. Stöcke Tom3  
184. Grunge Tom3  
185. 70er Tom3  
186. 80er Tom3  
187. Beliebter Tom3  
188. Slam Tom3  
189. Angriff Tom3  
190. Alter Tom3  
191. Fairfax Tom3  
192. Militärischer Tom3

**Absturz .**

193. Pop Crash1  
194. Scheiß auf Crash1  
195. Harter Absturz1  
196 . Original Crash1  
197 . PopRock Crash1

198. Felssturz1  
199. Metall-Crash1  
200 . PowerMetal Crash1  
201 . SpeedMetal Crash1 202 .  
PopJazz Crash1 203 . Jazz  
Crash1  
204 . 808  
205 . 909  
206 . Songo Crash1  
207 . Standard Crash1  
208 . Akustik-Crash1  
209. Seesion Crash1  
210. Moderner Absturz1  
211. Blues Crash1  
212. Klassischer Crash1  
213. Synthgaze Crash1 214.  
Freak Crash1  
215. Stöcke Crash1  
216 . Grunge Crash1  
217 . 70er Crash1  
218. 80er Crash1  
219. Beliebter Crash1 220.  
Slam Crash1  
221. Angriffsabsturz1  
222. Alter Absturz1  
223. Fairfax-Unfall1  
224. Militärischer Crash1 225.  
Pop Crash1 Rim 226. Fick  
Crash1 Rim  
227. Harte Crash1-Felge  
228 . Original Crash1 Felge 229 .  
PopRock Crash1 Felge 230 . Rock  
Crash1 Felge  
231. Metall Crash1 Felge  
232 . PowerMetal Crash1 Felge  
233 . SpeedMetal Crash1 Rim 234 .  
PopJazz Crash1 Rim 235 . Jazz  
Crash1 Rim  
236 . 808  
237 . 909  
238 . Songo Crash1 Felge  
239 . Standard Crash1 Felge  
240 . Akustik Crash1 Rim  
241. Seesion Crash1 Felge  
242. Moderne Crash1 Felge  
243. Blues Crash1 Felge  
244. Klassische Crash1-Felge  
245. Synthgaze Crash1 Rim 246.  
Freak Crash1 Rim  
247. Sticks Crash1 Felge  
248. Grunge Crash1 Felge 249.  
70er Crash1 Felge  
250. 80er Crash1 Felge  
251. Beliebte Crash1-Felge 252.  
Slam Crash1-Felge  
253. Angriff Crash1 Felge  
254. Alte Crash1 Felge  
255. Fairfax Crash1 Felge  
256. Militärische Crash1 Felge

**Fahrt .**

257. Pop-Fahrt  
258. Fick-Fahrt  
259. Harte Fahrt  
260 . Originalfahrt 261 .  
Pop-Rock-Fahrt

262. Rock Ride  
263. Metallfahrt  
264. PowerMetal-Fahrt  
265. SpeedMetal-Fahrt  
266. PopJazz Ride  
267. Jazz-Fahrt  
268 . 808  
269 . 909  
270. Songo lacht  
271. Standardfahrt  
272. Akustische Fahrt  
273. Seesion-Fahrt  
274. Moderne Fahrt  
275. Blues-Fahrt  
276. Klassische Fahrt  
277. Synthgaze-Fahrt  
278. Freak Ride  
279. Sticks-Fahrt  
280. Grunge-Fahrt  
281. 70er-Jahre-Fahrt  
282. 80er-Jahre-Fahrt  
283. Beliebte Fahrt  
284. Slam-Fahrt  
285. Angriffsfahrt  
286. Alte Fahrt  
287. Fairfax-Fahrt  
288. Militärischer Fahrt  
289. Pop Ride Felge  
290. Fick, Fahrt, Felge  
291. Hard Ride Felge  
292. Original Ride-Felge  
293 . PopRock Ride Rhythme  
294. Rock Ride Felge  
295. Metallfelge  
296. PowerMetal Ride Felge  
297. SpeedMetal Ride Felge  
298. PopJazz Ride Rim  
299. Jazz Ride Felge  
300 . 808  
301 . 909  
302. Songo-Fahrtfelge  
303. Standard-Fahrradfelge  
304. Akustik-Ride-Rand  
305. Seesion Ride Felge  
306. Moderne Fahrtfelge  
307. Blues Ride Felge  
308. Classic Ride-Felge  
309. Synthgaze-Fahrtfelge  
310. Freak Ride-Felge  
311. Sticks Ride Felge  
312. Grunge Ride Felge  
313. 70er Jahre Ride-Felge  
314. 80er Jahre Ride Felge  
315. Beliebte Ride Felge  
316. Slam Ride-Felge  
317. Angriffsfahrtfelge  
318. Alte Fahrtfelge  
319. Fairfax-Fahrradfelge  
320. Militärische Fahrtfelge

**Hallo Hut.**

321. Pop Hi-Hat offen  
322. Scheiß auf das offene Hi-Hat  
323. Hartes Hi-Hat offen  
324. Original-Hi-Hat offen  
325 . PopRock Hi-Hat Open

326 . Rock Hi-Hat offen 327 .  
Metal Hi-Hat offen 328 .  
PowerMetal Hi-Hat offen 329 .  
SpeedMetal Hi-Hat offen 330 .  
PopJazz Hi-Hat offen 331 . Jazz  
Hi-Hat offen  
332 . 808  
333. 909  
334. Songo Hi-Hat offen 335.  
Standard Hi-Hat offen 336. Acoustic  
Hi-Hat offen 337. Seesion Hi-Hat  
offen 338. Modern Hi-Hat offen  
339. Blues Hi-Hat offen 340.  
Classic Hi-Hat offen 341.  
Synthgaze Hi-Hat offen 342. Freak  
Hi-Hat offen 343. Sticks Hi-Hat offen  
344. Grunge Hi-Hat offen 345.  
70er Hi-Hat offen 346. 80er Hi-  
Hat offen 347. Populärer Hi-Hat  
offen 348. Slam Hi-Hat offen  
349. Attack Hi-Hat offen 350.  
Old Hi-Hat offen 351. Fairfax Hi-  
Hat offen 352. Military Hi-Hat  
offen 353. Pop Hi-Hat geschlossen

354. Scheiß auf die Hi-Hat  
355. Hartes Hi-Hat-Close-up  
356. Original Hi-Hat Schließen 357.  
PopRock Hi-Hat Schließen  
358. Rock Hi-Hat Schließen  
359 . Metal Hi-Hat Schließen  
360 . PowerMetal Hi-Hat Schließen  
361. SpeedMetal Hi-Hat Schließen 362.  
PopJazz Hi-Hat Schließen  
363. Jazz Hi-Hat Schließen  
364 . 808  
365 . 909  
366. Songo Hi-Hat Schließen  
367. Standard-Hi-Hat-Schließen  
368 . Akustische Hi-Hat Schließen  
369. Seesion Hi-Hat Schließen  
370. Modernes Hi-Hat Schließen  
371. Blues Hi-Hat Schließen  
372. Klassisches Hi-Hat Schließen  
373. Synthgaze Hi-Hat Schließen  
374. Freak Hi-Hat Schließen  
375. Sticks Hi-Hat Schließen  
376. Grunge Hi-Hat Schließen  
377. 70er Hi-Hat-Close  
378. 80er Hi-Hat Close  
379. Beliebte Hi-Hat Schließen  
380. Slam Hi-Hat Schließen  
381. Attack Hi-Hat Schließen  
382. Altes Hi-Hat Close  
383. Fairfax Hi-Hat Schließen  
384. Militärischer Hi-Hat Schließen 385.  
Pop-Hi-Hat-Pedal  
386. Scheiß auf das Hi-Hat-Pedal  
387. Hartes Hi-Hat-Pedal  
388 . Originales Hi-Hat-Pedal 389.  
PopRock Hi-Hat-Pedal  
390 . Rock-Hi-Hat-Pedal  
391. Hi-Hat-Pedal aus Metall  
392 . PowerMetal Hi-Hat-Pedal  
393. SpeedMetal Hi-Hat-Pedal 394.  
PopJazz Hi-Hat-Pedal  
395. Jazz-Hi-Hat-Pedal  
396 . 808  
397 . 909  
398 . Songo Hi-Hat-Pedal  
399 . Standard-Hi-Hat-Pedal



## APPENDIX

400 . Akustisches Hi-Hat-Pedal		433. Seesion Crash2	450. Scheiß auf die Crash2-Felge	467. Blues Crash2 Felge
401. Seesion Hi-Hat-Pedal	417. Pop Crash2	434. Moderner Absturz2	451. Harte Crash2-Felge	468. Klassische Crash2-Felge
402 . Modern Hi-Hat Pedal	418. Scheiß auf Crash2	435. Blues Crash2	452. Original Crash2 Felge	469. Synthgaze Crash2 Felge
403. Blues Hi-Hat-Pedal 404.	419. Harter Absturz2	436. Klassischer Crash2	453 . PopRock Crash2 Rhytm	470. Freak Crash2 Felge
Klassisches Hi-Hat-Pedal 405.	420 . Original Crash2	437. Synthgaze Crash2	454. Rock Crash2 Felge	471 . Sticks Crash2 Felge
Synthgaze Hi-Hat-Pedal	421 . PopRock Crash2	438. Freak Crash2	455. Metall-Crash2-Felge	472. Grunge Crash2 Felge
406. Freak Hi-Hat-Pedal	422. Felssturz2	439. Stöcke Crash2	456 . PowerMetal Crash2 Felge	473. 70er Crash2 Felge
407 . Sticks Hi-Hat-Pedal	423. Metall Crash2	440 . Grunge Crash2	457. SpeedMetal Crash2 Felge	474. 80er Crash2 Felge
408 . Grunge Hi-Hat-Pedal	424 . PowerMetal Crash2	441. 70er Crash2	458 . PopJazz Crash2 Rim	475. Beliebte Crash2 Felge
409 . 70er Hi-Hat-Pedal	425. SpeedMetal Crash2	442. 80er Crash2	459. Jazz Crash2 Felge	476. Slam Crash2 Felge
410 . 80er Hi-Hat-Pedal	426. PopJazz Crash2	443. Beliebter Crash2	460 . 808	477. Attack Crash2 Felge
411 . Beliebtes Hi-Hat-Pedal	427. Jazz Crash2	444 . Slam Crash2	461 . 909	478. Alte Crash2-Felge
412 . Slam Hi-Hat-Pedal	428 . 808	445. Angriffsabsturz2	462 . Songo Crash2 Felge	479. Fairfax Crash2 Felge
413 . Attack Hi-Hat-Pedal	429 . 909	446. Alter Crash2	463. Standard-Crash2-Felge	480. Militärische Crash2-Felge
414 . Altes Hi-Hat-Pedal	430. Songo-Absturz2	447. Fairfax-Unfall2	464 . Akustik Crash2 Felge	
415 . Fairfax Hi-Hat-Pedal	431. Standard-Crash2	448. Militärischer Absturz2	465. Seesion Crash2 Felge	
416 . Militärisches Hi-Hat-Pedal	432. Akustischer Crash2	449. Pop Crash2 Felge	466. Moderne Crash2-Felge	

Absturz 2

### Drum combination timbre

01 Pop	09 SpeedMetal
02 Ficken	10 PopJazz
03 Schwer	11 Jazz
04 Original	12 808
05 Pop-Rock	13 909
06 Felsen	14 Songo
07 Metall	15 Norm
08 PowerMetal	16 Akustik

### User drum group

17. Sitzung	25 70er Jahre
18 Moderne	26 80er Jahre
19 Blues	27 Beliebt
20 Klassisch	28 Schlag
21 Synthblick	29 Angriff
22 Freak	30 Alt
23 Stöcke	31 Fairfax
24 Grunge	32 Militär

### Demonstration music

Lied 001	Lied 007	Lied 013	Lied 019	Lied 025
Lied 002	Lied 008	Lied 014	Lied 020	Lied 026
Lied 003	Lied 009	Lied 015	Lied 021	Lied 027
Lied 004	Lied 010	Lied 016	Lied 022	Lied 028
Lied 005	Lied 011	Lied 017	Lied 023	Lied 029
Lied 006	Lied 012	Lied 018	Lied 024	Lied 030



## PRODUKTWARTUNG

Eine sorgfältige Wartung und der Schutz dieses Produkts tragen wesentlich dazu bei, seine Lebensdauer zu verlängern und Fehler zu reduzieren.

#### 1 Vermeiden Sie Hitze, Feuchtigkeit oder direkte Sonneneinstrahlung

Setzen Sie das Produkt nicht übermäßig direktem Sonnenlicht aus und platzieren Sie es nicht in der Nähe einer Klimaanlage oder an einem extrem heißen Ort.

#### 2 Nicht in der Nähe von Fernsehgeräten oder Radios verwenden

Dieses Produkt kann den Empfang von Fernseh- und Radiosendern stören. Wenn dies passiert, entfernen Sie das Produkt vom Fernsehgerät oder Radio.



## PRODUKTWARTUNG

### 3 Verwenden Sie keine Farbe, Verdüner oder ähnliche Chemikalien zum Reinigen

Bitte verwenden Sie ein weiches und schmutzfreies Reinigungstuch, das Sie in etwas Wasser oder ein spezielles Reinigungsmittel getaucht haben, um oberflächliche Flecken auf diesem Produkt zu entfernen.

### 4 Nicht schütteln, um eine Kollision zu vermeiden

Beim Transportieren des Produkts ist Vorsicht geboten. Heftige Erschütterungen und Stöße sind strengstens verboten, um Schäden am Gehäuse oder an den internen elektronischen Komponenten zu vermeiden.



## SAFETY PRECAUTIONS

### POWER SUPPLY

This product can be powered by standard indoor wall sockets. Please only use the power cord specified in this product. When not in use, please turn off the power supply. When not in use for a long time, pull out the power cord and keep it properly.

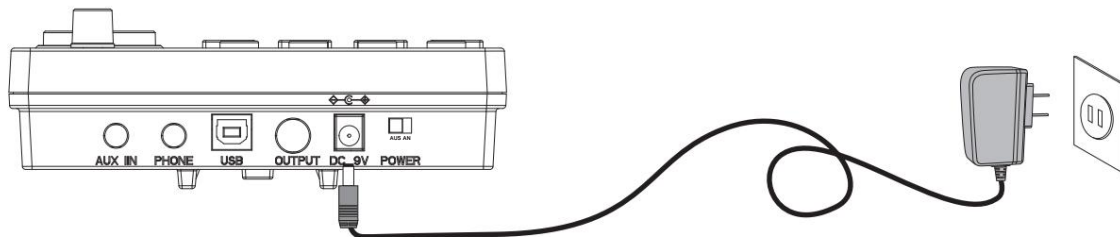

### SIGN

To ensure that you use this product safely and correctly, to prevent harm to users and others and financial damage, this manual and products are marked with a series of safety signs. The various signs and their meanings are as follows:

#### **WARNING**

This sign indicates that there is a potential risk of death or serious injury if this mark is ignored and the product is mishandled.

#### **BE CAREFUL**

This sign indicates that there is a potential danger of injury to personnel or other financial damage if this sign is ignored and the product is operated incorrectly.

### EXAMPLE OF LOGO



This triangle sign ( $\Delta$ ) indicates what users should pay attention to. (The left example is careful shocks)



A circular sign ( $\ominus$ ) with an oblique line indicates prohibitions. The icons in or beside the logo indicate the contents specifically prohibited. (The example on the left is no disassembly)



The round black bottom sign ( $\oplus$ ) indicates what must be observed. The diagrams in this sign indicate the contents of the specific matters that must be observed. (The example on the left is that the power plug must be pulled out of the socket)



## SAFETY PRECAUTIONS

### WARNING

#### Smoke, odor, overheating

When the product smokes, smells or overheats, there is a danger of fire and electric shock when it is used continually. In case of the above situation, the following operations should be performed immediately:

1. Turn off the power supply.
2. Pull the plug out of the power outlet.
3. Contact your dealer.

#### Power cord

1. The improper use of power cord may cause fire and electric shock. The following precautions must be observed:
  - The special power cord designated for this product must be used.
  - The AC power supply with output voltage within the rated voltage range for household use must be used.
  - Do not overload power sockets and extension lines.
2. The improper treatment of power line will lead to its damage or breakage, which will cause fire and electric shock hazards. The following precautions must be observed:
  - Do not place or heat heavy objects on power lines.
  - Do not attempt to alter or bend the power cord too much.
  - Do not twist or pull the power cord.
  - If the power cord or plug is damaged, please replace the same type of power cord.
3. Do not touch the power cord and plug with wet hands, otherwise there is a danger of electric shock.
4. Please use the power cord where the water will not splash. Water is in danger of causing fire and electric shock.
5. Never place vases or any other container containing water on this product. Water is dangerous of causing fire and electric shock.
6. Do not allow minors to unplug and touch power lines or connection boards. Minors have no common sense of electricity safety, which may cause electric shock.

### BE CAREFUL

The improper use of power cord may cause fire and electric shock. The following precautions must be observed:

- Never put the power cord near the oven or other heat source.
- Do not pull the cable when pulling out of the power socket. The main body of the plug must be grasped.
- The power cord plug must be inserted in the socket to the end.
- Make sure the power supply is off before connecting or disconnecting it.
- When thunderstorms occur or before traveling or other long-term departure, disconnect the power cord from the wall outlet.
- At least once a year, remove the power cord from the wall outlet and clean the dust accumulated around the plug.

#### Do not burn this product

Do not put this product in the fire, otherwise it will lead to product combustion and explosion of internal electronic components, which will cause fire and personnel injury.

#### Water and foreign bodies

Water, other liquids and (metal sheets, etc.) entering this product are in danger of causing fire and electric shock. In case of the above situation, the following operations shall be performed immediately:

1. Turn off the power supply.
2. If you are using a power cord for power supply, unplug it from the wall outlet.
3. Contact your distributor.

#### Disassembly and transformation

Do not disassemble or transform the product in any way, otherwise there is a risk of electric shock, scald or other personal injury. All internal inspection, adjustment and maintenance operations should be entrusted to your distributor.



## SAFETY PRECAUTIONS

### Falling or colliding

If the product falls or is damaged by strong impact, it will be in danger of causing fire and electric shock. In case of the above situation, the following operations shall be performed immediately:

1. Turn off the power supply.
2. If you are using a power cord for power supply, you need to unplug it from the wall outlet.
3. Contact your distributor.



### Plastic bag

Do not let anyone put plastic bags for this product on his head or in his mouth. Otherwise, there is a risk of asphyxia. Families with young children should pay special attention to it.



### Keep a distance from the product and the bracket

Climbing the bracket is dangerous of overturning or damage. Families with young children should pay special attention to it.



### Put

Avoid placing the product on an uneven surface or any other unstable place. Otherwise, it will cause the product to fall down, which will lead to the risk of injury.



### Product Mobility

Before moving this product, you must unplug the power cord plug from the wall outlet and pull out all other cables and connecting wires. Otherwise, it will lead to damage of power or connection wires, resulting in fire and electric shock.



### clean

Before cleaning this product, you must unplug the power cord plug from the wall outlet, otherwise there is a risk of fire and electric shock.



### Jack

The socket of this product can only be connected to the designated equipment and devices. Connecting non-designated equipment or devices is dangerous of causing fire and electric shock.



### Location selection

It should be avoided to place the product in the following places, otherwise there is a risk of fire and electric shock.



- High temperature or dusty places.
- Kitchen or other places with lampblack.
- Where the product is exposed to direct sunlight, or any other place where the product will produce high temperature.

### Volume

Don't play music long and loud. Pay special attention when using headphones. Excessive volume can damage your hearing.



### Heavy



Do not place heavy objects on this product. Otherwise, the top of the product will be overweight, causing the product to overturn or drop objects on it, which will lead to the risk of injury.



### Correct assembly of scaffolds

The incorrect assembly of the bracket may overturn, causing the product to fall off and posing a risk of injury to personnel. Therefore, it must be assembled according to the instructions in the attached installation guide to ensure that the product is properly mounted on its bracket.



	<p>Warnung: Um das Verletzungsrisiko zu verringern, muss der Benutzer die Bedienungsanleitung sorgfältig lesen.</p>
	<p>Dieses Gerät entspricht Teil 15 der FCC-Bestimmungen. Der Betrieb unterliegt den folgenden beiden Bedingungen: (1) Dieses Gerät darf keine schädlichen Störungen verursachen und (2) dieses Gerät muss alle empfangenen Störungen akzeptieren, einschließlich Störungen, die einen unerwünschten Betrieb verursachen können.</p>
	<p>Dieses Produkt unterliegt den Bestimmungen der europäischen Richtlinie 2012/19/EU. Das Symbol einer durchgestrichenen Mülltonne weist darauf hin, dass das Produkt in der Europäischen Union einer getrennten Müllentsorgung unterliegt. Dies gilt für das Produkt und alle mit diesem Symbol gekennzeichneten Zubehörteile. So gekennzeichnete Produkte dürfen nicht im normalen Hausmüll entsorgt werden, sondern müssen an einer Sammelstelle für das Recycling von elektrischen und elektronischen Geräten abgegeben werden.</p>

**Hersteller:** Shanghaimuxinmuyeyouxiangongsi

**Adresse:** Shuangchenglu 803nong11hao1602A-1609shi, baoshanqu, Shanghai 200000 CN.

**Nach AUS importiert:** SIHAO PTY LTD, 1 ROKEVA STREETEASTWOOD NSW 2122 Australien

**Importiert in die USA:** Sanven Technology Ltd., Suite 250, 9166 Anaheim Place, Rancho Cucamonga, CA 91730

<p><b>Vertreter der EG</b></p>	
--------------------------------	--

E-CrossStu GmbH  
Mainzer Landstr.69, 60329 Frankfurt am Main.

<p><b>UK REP</b></p>	
----------------------	--

YH CONSULTING LIMITED.  
C/O YH Consulting Limited Office 147, Centurion House,  
London Road, Staines-upon-Thames, Surrey, TW18 4AX



**VEVOR**<sup>®</sup>

**TOUGH TOOLS, HALF PRICE**

**Technischer Support und E-Garantie-Zertifikat**

**[www.vevor.com/support](http://www.vevor.com/support)**

# VEVOR®

## TOUGH TOOLS, HALF PRICE

Supporto tecnico e certificato di garanzia

elettronica [www.vevor.com/support](http://www.vevor.com/support)

## BATTERIA ELETTRONICA

### MANUALE D'USO

MODELLO: MD200F-P

Continuiamo a impegnarci per fornirvi strumenti a prezzi competitivi.

"Risparmia metà", "Metà prezzo" o qualsiasi altra espressione simile da noi utilizzata rappresenta solo una stima del risparmio che potresti trarre dall'acquistare determinati strumenti con noi rispetto ai principali marchi più importanti e non significa necessariamente coprire tutte le categorie di strumenti offerto da noi. Ti ricordiamo gentilmente di verificare attentamente quando effettui un ordine con noi se stai effettivamente risparmiando la metà rispetto ai migliori marchi principali.

**VEVOR**<sup>®</sup>  
TOUGH TOOLS, HALF PRICE

BATTERIA ELETTRONICA

MODELLO: MD200F-

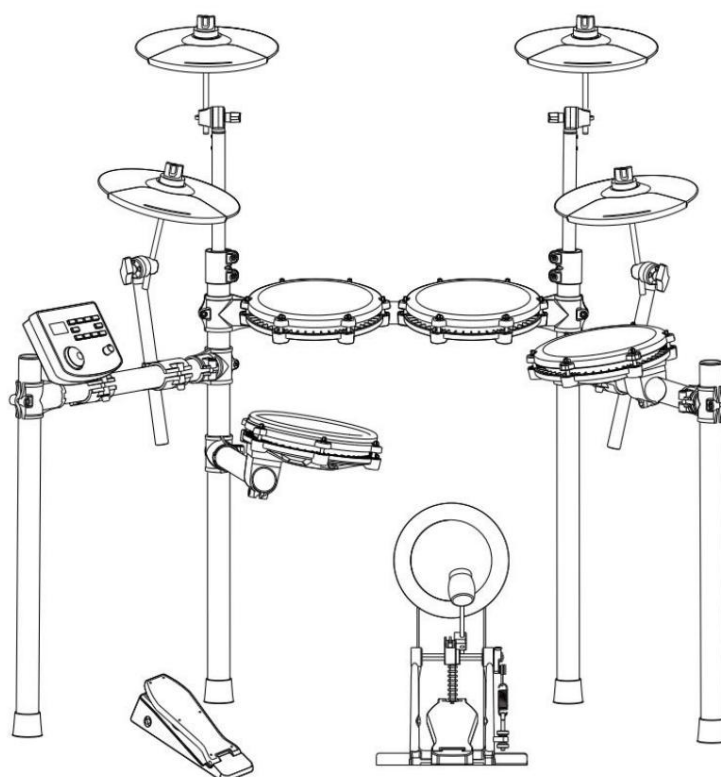

(L'immagine è solo di riferimento, fare riferimento all'oggetto reale )

### HO BISOGNO DI AIUTO? CONTATTACI!

Hai domande sul prodotto? Hai bisogno di supporto tecnico? Sentiti libero di contattaci:

**Supporto tecnico e certificato di garanzia elettronica**

**[www.vevor.com/support](http://www.vevor.com/support)**

Queste sono le istruzioni originali, leggere attentamente tutte le istruzioni del manuale prima dell'uso. VEVOR si riserva una chiara interpretazione del nostro manuale d'uso. L'aspetto del prodotto sarà soggetto al prodotto ricevuto. Ti preghiamo di perdonarci se non ti informeremo più se sono presenti aggiornamenti tecnologici o software sul nostro prodotto.



## INTRODUZIONE ALLA FUNZIONE

Grazie per aver scelto la nostra batteria elettronica. Il tamburo elettronico elegante e delicato è la combinazione perfetta della nuova tecnologia elettronica moderna. •Prima di utilizzare questo prodotto, è necessario leggere le istruzioni in dettaglio.

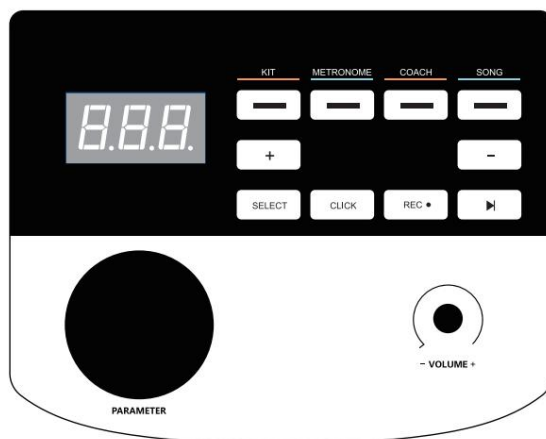

- 32 set di tamburi, 480 timbri
- 30 canzoni
- Supporta la regolazione dei parametri di sensibilità di ciascun tamburo
- Tre modalità di insegnamento
- Controllo della velocità: 30 ~ 250 battiti/min
- Metronomo: 1-9 tipi
- Altre funzioni: memorizzazione, reset e registrazione dei parametri;
- display led a tre cifre;
- interfaccia: alimentatore cc, usbmidi, auricolare, ingresso audio, uscita audio

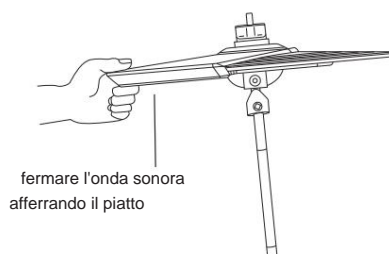
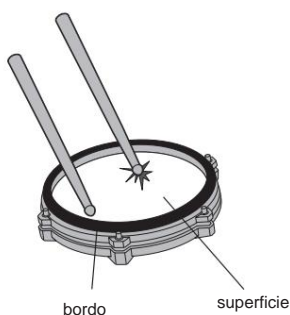

### NOTA!

- Questo prodotto è uno strumento elettroacustico. È normale che dopo l'accensione si senta una leggera corrente nell'altoparlante o negli auricolari. Tenere lontano da "radio, TV, ricevitori d'antenna, router, frigorifero, TV, motore e altre fonti di interferenza elettrica RF" durante l'uso.



## CONTENUTI

<b>INTRODUZIONE FUNZIONI</b>	<b>1</b>
<b>CONTENUTI</b>	<b>2</b>
<b>GUIDA D'INSTALLAZIONE</b>	<b>3</b>
VERIFICA GLI ARTICOLI ALLEGATI	3
SUPPORTO TUBO LRON	4
INTUBAZIONE TIMPANICA	4
SUPPORTO DI MONTAGGIO	5
INSTALLARE IL MODULO TAMBURO	5
INSTALLARE LE PARTI DI PERCUSSIONE E IL MODULO AUDIO	6
INSTALLARE IL TAMBURO	7
INSTALLARE LA BARRA DEL MARTELLO	7
IL TAMBURO È FISSATO CON IL MARTELLO STEP	7
INSERIRE IL CAVO DI COLLEGAMENTO DELLA PARTE IN CONTROSTO	7
<b>ILLUSTRAZIONE DELLA PORTA DEL MODULO AUDIO</b>	<b>8</b>
COLLEGAMENTO DEL CAVO DI ALIMENTAZIONE	8
PORTA MIDI USB	8
PORTA DI USCITA AUDIO	8
PORTA DI INGRESSO AUDIO	8
PORTA PER AURICOLARI	8
AUMENTA PORTA	8
MODALITÀ BT	8
<b>GUIDA OPERATIVA</b>	<b>9</b>
ENERGIA	9
SELEZIONE DEL DRUM KIT	9
METRONOMO	9
FUNZIONE PRATICA	9
MODALITÀ ALLENATORE	9
BRANI DEMO	10
PARAMETRI TAMBURO	10
FUNZIONE DI REGISTRAZIONE	10
SALVA/AZZERA	10
USB MIDI	11
<b>APPENDICE</b>	<b>11</b>
TIMBRO	11
KIT TAMBURO PRESET	11
DRUM KIT DEFINITI DALL'UTENTE	11
BRANO DEMO STRAZIONE	11
<b>MANUTENZIONE DEL PRODOTTO</b>	<b>12</b>
<b>MISURE DI SICUREZZA</b>	<b>13</b>



## GUIDA D'INSTALLAZIONE

### NOTA!

- Seguire le istruzioni e leggere attentamente le "precauzioni di sicurezza" nel Manuale dell'utente prima di usare .
- Questo prodotto deve essere installato da un adulto, non lasciare che il minore lo installi in modo indipendente.

# 01

### Controlla gli articoli allegati

- Dopo aver aperto la confezione, verificare immediatamente se contiene tutti gli articoli. In caso di omissioni, contattare il rivenditore.



Modulo sonoro



Staffa del modulo



Piatto \*4

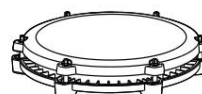

Tom (3 pezzi)



Rullante



Supporto posteriore



Staffa di collegamento



Staffa anteriore



Calcio

2 pezzi 2 pezzi 6 pezzi



vite

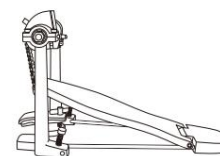

Pedale della scossa



Braccio del piatto  
(4 pezzi)



Ciao pedale



Cacciavite



Cavo di collegamento del segnale



Chiave del tamburo



Adattatore di alimentazione



Bacchetta per tamburo



Martello a bastone



## DISEGNO DI MONTAGGIO

### 02

### portatubo in ferro

- Il supporto si trova in un piccolo pacchetto individuale all'interno della scatola.

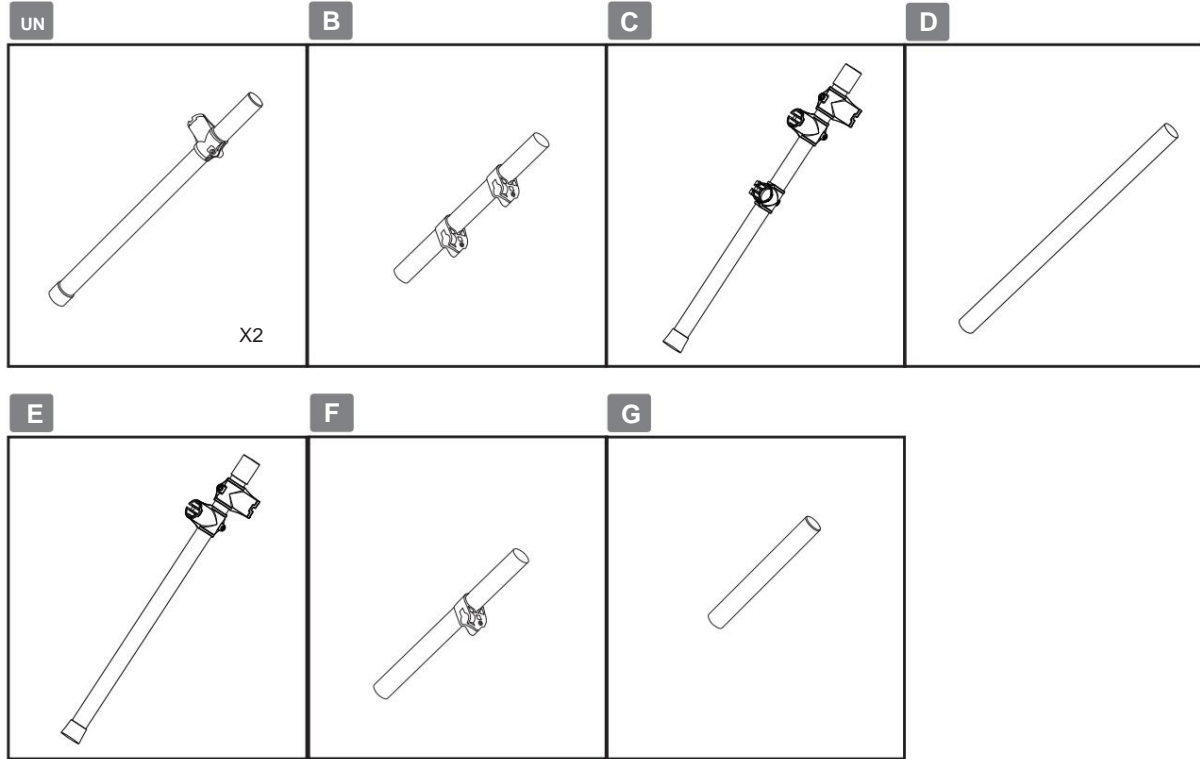

### 03 Intubazione timpanica

Installare il tamburo sulla barra di supporto del tamburo.

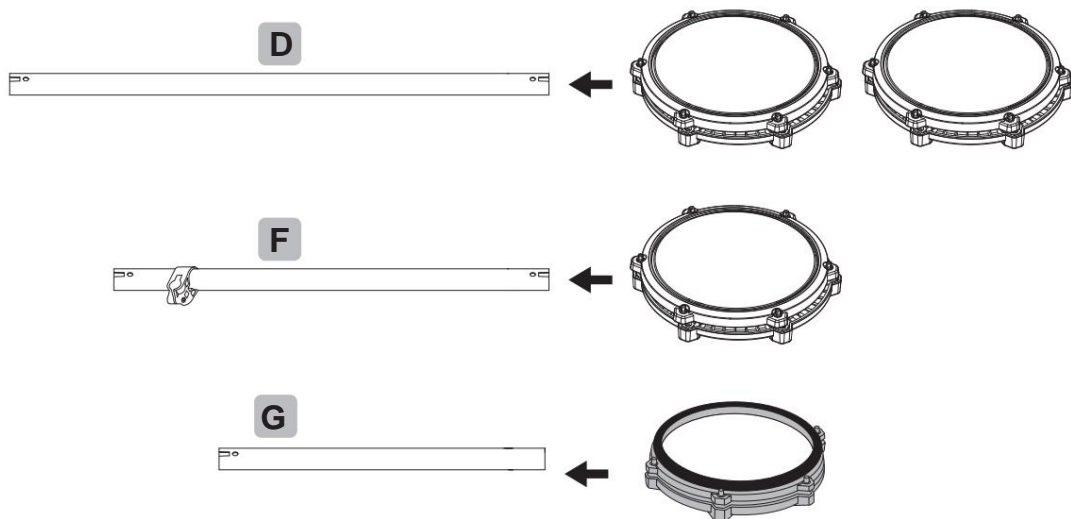



## GUIDA D'INSTALLAZIONE

### 04

#### Supporto di montaggio

- Durante l'installazione, stringere le viti e fare attenzione a pizzicarsi le dita.
- Assemblare la staffa nella direzione specificata

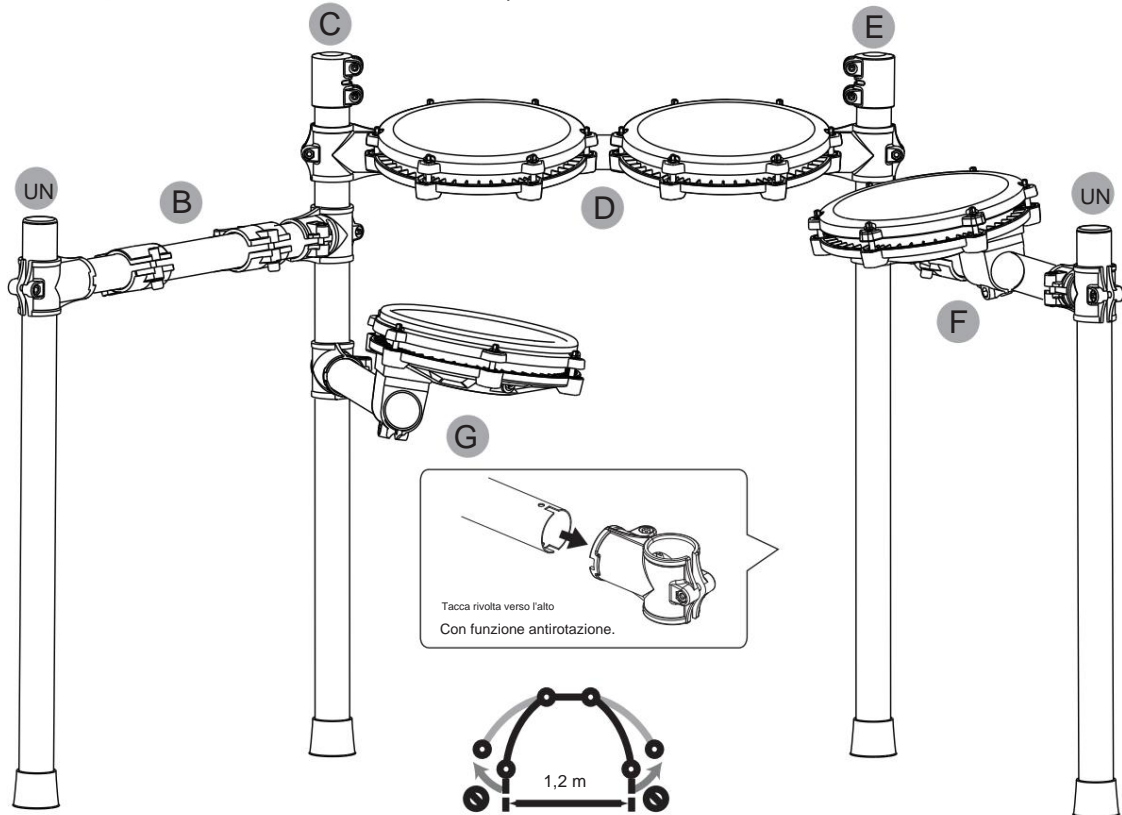

Per ragioni di sicurezza, la larghezza di espansione del supporto non deve essere superiore a 1,2 metri.

### 05

#### Installare il modulo per batteria

- Si prega di inserirlo in posizione durante lo stallo.

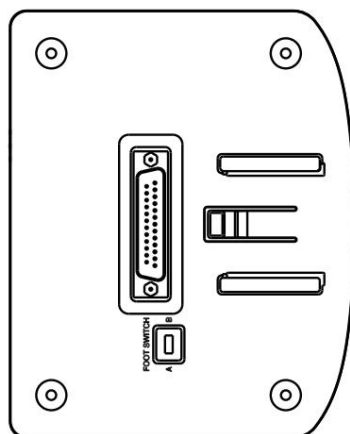

Allineare il modulo del tamburo del mainframe al binario della scatola del mainframe e inserirlo. Dopo averlo inserito fino in fondo, puoi sentire i pezzi a scatto saltare fuori.

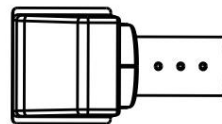



## GUIDA D'INSTALLAZIONE

# 06

### Installare le parti che colpiscono e il modulo sonoro

- Stringere le viti dopo aver inserito il tamburo per evitare che si allenti.
- Assicurarsi di non stringere troppo i piatti, lasciare un po' di spazio affinché possano muoversi su e giù.

Ritirare i dadi e i cuscinetti circolari del braccio dei tre piatti, inserire i tre piatti nel braccio corrispondente e avvitare i dadi. Inserire rispettivamente 3 fusti e 1 fusto nell'asta di supporto corrispondente e serrare le viti.

Nota: le funzioni di ciascun piatto, tom e rullante sono diverse, quindi è necessario fare riferimento all'identificazione dell'accessorio per una corretta installazione!

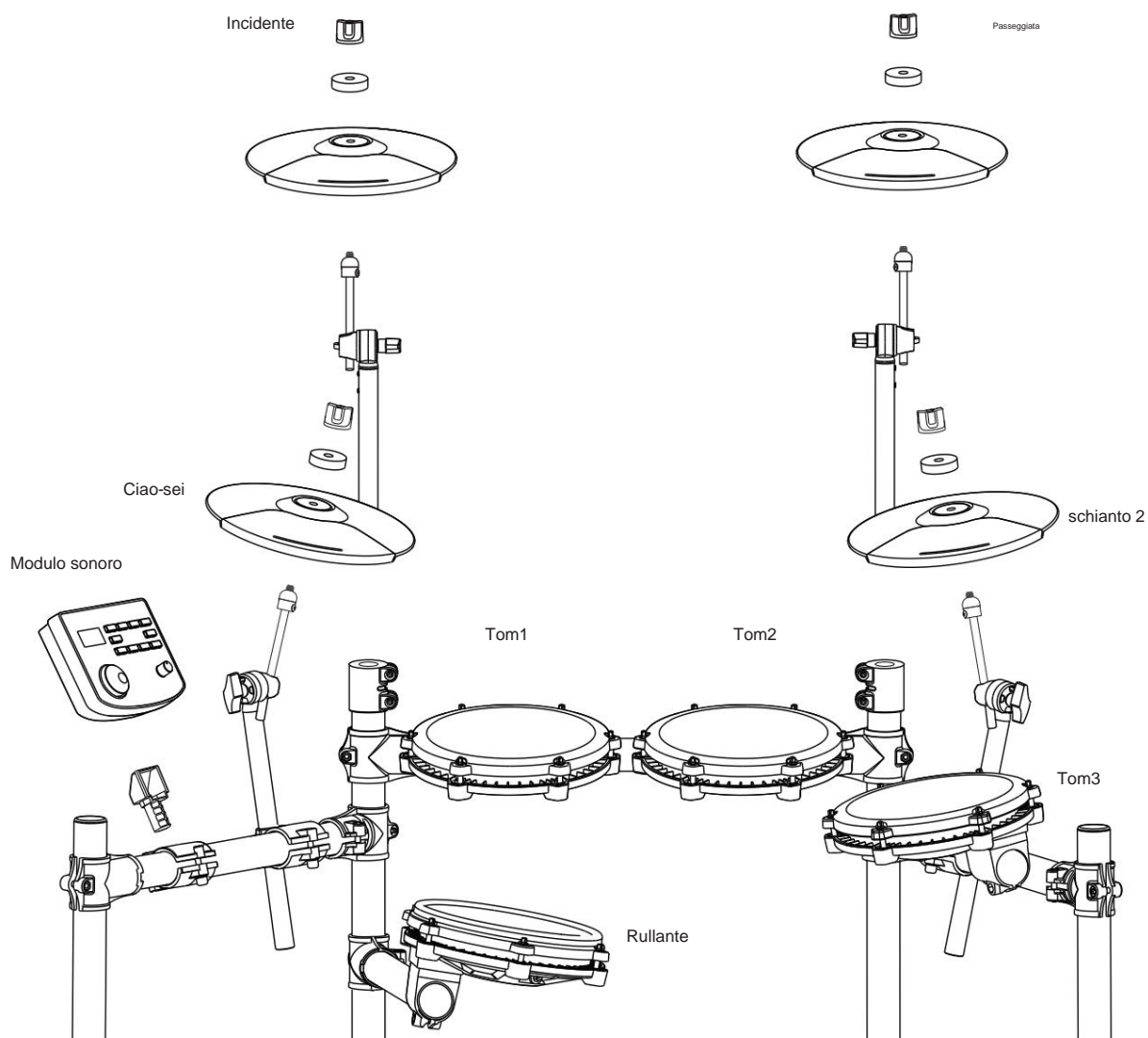



## GUIDA D'INSTALLAZIONE

### 07

#### Installa la grancassa

- durante l'installazione, stringere le viti e fare attenzione a non pizzicarsi le dita.

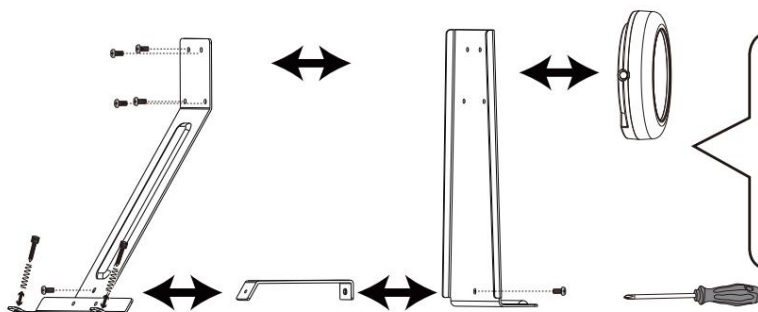

Utilizzare un cacciavite per fissare il tamburo inferiore, fissaggi come mostrato, sostenere le parti con 6 piccole viti. Quindi inserire 2 molle in 2 viti antisivolo e bloccare le 2 molle nella parte inferiore del pezzo di supporto finché non poggia a terra.

### 08

#### Installare la barra del martello

- il palo deve essere inserito in pizzo e le viti devono essere serrate per evitare l'allentamento.

Inserire l'asta del martello nel foro rotondo come mostrato in figura, ruotare il martello da lana per allinearli alla superficie del tamburo, e poi stringerlo con la chiave del tamburo.

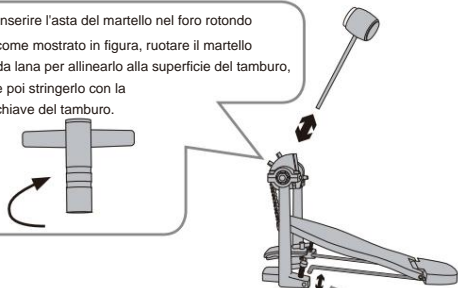

Inserire la barra di ferro fissa nel foro come mostrato nella figura.

### 09

#### La grancassa è fissata con il martello passo

- il tamburo inferiore e il martello a gradini devono essere fissati e stretti per evitare di cadere.



Inserire il bordo sporgente del tamburo basso nel clip di fissaggio del martello come mostrato nella figura e stringere le viti.

### 10

#### Collegare il cavo di collegamento della parte d'urto

- Si prega di inserire il cavo di collegamento in posizione per evitare uno scarso contatto e inserirlo correttamente come mostrato nel diagramma.

Si prega di verificare se il tamburo inferiore emette suono. Se non viene emesso alcun suono, ruotare l'interruttore:  
Passa in A: modalità grancassa meccanica  
Interruttore in B: modalità pedale.

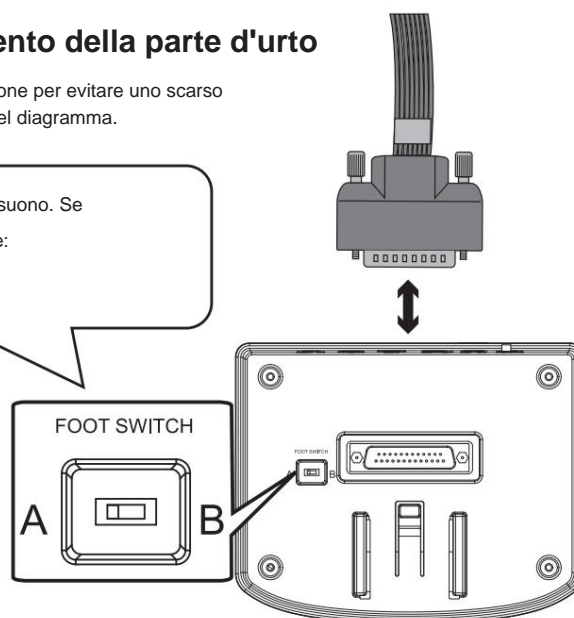



## ILLUSTRAZIONE DELLA PORTA DEL MODULO AUDIO

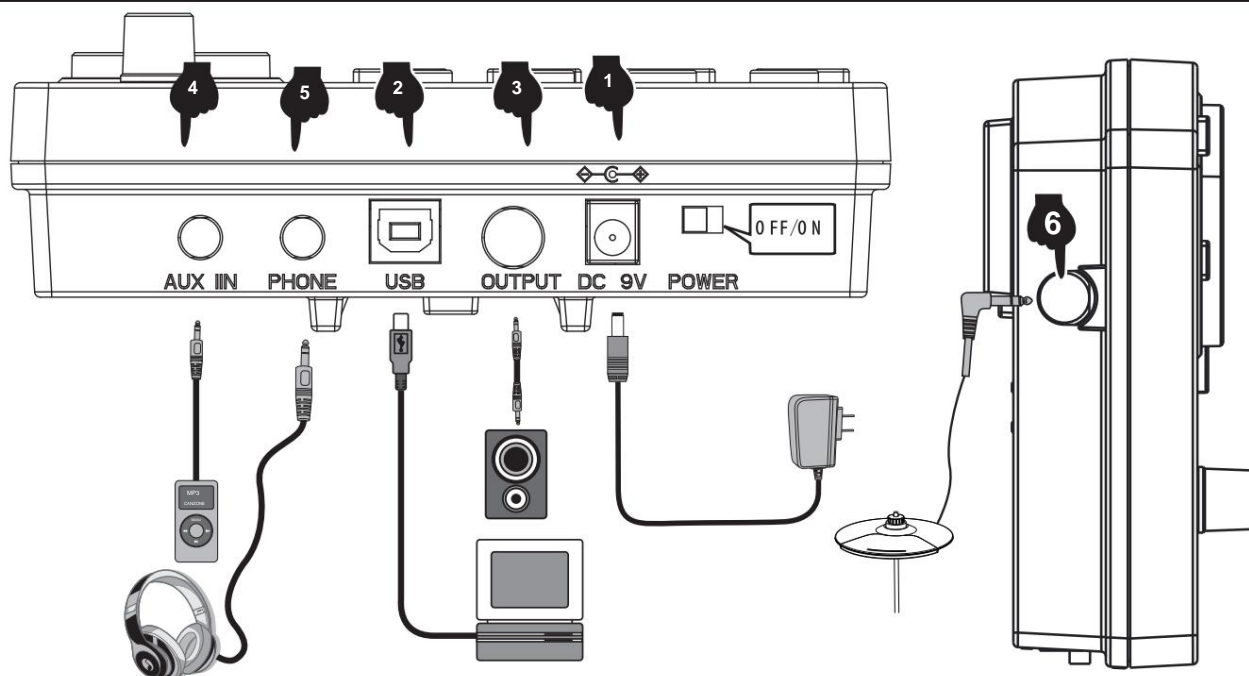

### 1 COLLEGAMENTO DEL CAVO DI ALIMENTAZIONE

1. Quando è in uso, collegare il terminale di alimentazione secondo lo schema, inserire la presa di corrente del modulo audio ad un'estremità e presa di corrente domestica da 100-240 V all'altra estremità. (Fig. 1)
2. Se non si utilizza questo prodotto per un lungo periodo, staccare la spina di alimentazione e conservarla correttamente.

### 2 PORTA MIDI USB

L'uso dell'interfaccia USB MIDI per batteria elettronica può interagire con dispositivi musicali con MIDI.

1. Attraverso il software Musica preinstallato su computer e telefoni cellulari, possiamo imparare a suonare, comporre musica, negozio e altre funzioni. (Fig. 2)
2. Quando è collegato a un computer o telefono cellulare, l'uscita audio del dispositivo deve essere collegata alla presa di ingresso audio del box modulare per sincronizzare gli effetti sonori sul dispositivo. (figura 5)

### 3 PORTA DI USCITA AUDIO

La porta di uscita audio può essere collegata ad un altoparlante attivo (altoparlante speciale per batteria elettronica) e ad apparecchiature audio di grandi dimensioni. (figura 3)

### 4 PORTA DI INGRESSO AUDIO

La porta di ingresso audio può collegare il dispositivo di riproduzione della sorgente audio al box del modulo per la riproduzione (come un telefono cellulare MP3 e altro ingresso di segnale audio). (Fig. 4)

### 5 PORTA PER AURICOLARI

Il collegamento delle cuffie monitora i dettagli delle percussioni e non disturba gli altri quando si suona senza connessione Altoparlanti. (figura 5)

### 6 AUMENTA PORTA

Questa porta consente di aggiungere un piatto per una facile espansione. (Figura 6)



# GUIDA OPERATIVA

## 1 POTENZA

Inserire la spina CC nella porta CC 9 V sulla parte superiore dell'unità di controllo. Far scorrere l'interruttore POWER verso destra (visto da la parte anteriore) per accendere il drum kit. Per spegnere il drum kit, far scorrere l'interruttore verso sinistra.

## 2 SELEZIONE DEL KIT TAMBURO

Premere il pulsante KIT per mostrare il drum kit corrente. Girare la rotella dei parametri o utilizzare i pulsanti <- /+> per selezionare quello desiderato drum kit. Sono disponibili 32 drum kit tra cui scegliere: vedere l'elenco dei drum kit a pagina 11.

## 3 METRONOMO

1. Premere il pulsante METRONOME per accedere alla modalità metronomo.
2. Lo schermo visualizzerà il valore della velocità (velocità predefinita 120 BPM). Girare la rotella dei parametri o utilizzare i pulsanti +/- per cambiare la velocità del metronomo. Premere il pulsante CLICK per avviare il metronomo.
3. Premere il pulsante SELECT in modalità metronomo e lo schermo passerà alla regolazione dei parametri del metronomo interfaccia. È possibile premere i pulsanti +/- per selezionare il parametro che si desidera regolare:
  - A. r\tipo di battuta:2,4,8,16\
  - B. b (numero di battute: 01-09)
  - C. L(volume metronomo: 00 (off) -31), quindi girare la rotella dei parametri per regolare le impostazioni dei parametri.
4. Una volta che i parametri sono stati regolati, premere il pulsante SELEZIONA per confermare e uscire dall'interfaccia dei parametri. Quindi utilizzare il pulsante CLICK per avviare e arrestare il metronomo come desiderato.

## 4 FUNZIONE PRATICA

La modalità "allenatore" di questo prodotto può aiutare a stabilire velocità, precisione e resistenza e aiutare a coltivare la funzione pratica di un migliore senso del ritmo. Fai progressi sotto la supervisione della modalità allenatore "allenatore"!

Premere il pulsante "coach" per accedere alla modalità allenatore. In questa modalità, ci sono tre modalità di pratica. Seleziona la pratica modalità tramite la ruota dati o il pulsante < + > < - >.

1. Modalità di esercizio 1: Esercizio di rilevamento del battito C-1: batti il tamburo a una velocità fissa per allenare la precisione del colpo.
2. Modalità pratica 2: modalità colpo silenzioso C-2: il metronomo suonerà una sezione e silenzierà una sezione per addestrare il precisione del colpo senza il prompt del metronomo. È una versione avanzata della modalità pratica 1.
3. Modalità pratica 3: pratica del colpo di velocità C-3, il metronomo cambierà automaticamente la velocità, aumenterà dall'espresso più lento a quello più veloce, quindi ridurre dall'espresso più lento alla velocità più lenta, così come per praticare la resistenza al colpo.

## 5 MODALITÀ ALLENATORE

1. La modalità di allenamento "coach" di questo prodotto può aiutare a stabilire velocità, precisione e resistenza. Premere COACH pulsante per accedere alla modalità allenatore. In questa modalità, ci sono tre modalità di pratica. Usa la ruota dei parametri per selezionare quale modalità pratica.
  - A. Modalità di esercizio 1: Esercizio di rilevamento del battito C-1: batti il tamburo a una velocità fissa per allenare la precisione del colpo.
  - B. Modalità pratica 2: C-2 modalità colpo silenzioso: il metronomo suonerà una sezione e disattiverà una sezione per allenarsi quando non c'è battito.
  - C. Modalità pratica 3: pratica del colpo di velocità C-3: il metronomo cambierà automaticamente la velocità dalla più lenta al più veloce e poi dal più veloce al più lento.
2. Una volta scelta la modalità coaching, premere il pulsante CLIC. I battiti del metronomo inizieranno e tu potrai farlo suonare il tamburo per esercitarsi.
3. Dopo quattro battute preliminari, il display mostrerà:

(troppo lento)



(Bene)



(troppo veloce)





## GUIDA OPERATIVA

4. Una volta completata la modalità coaching verrà visualizzato un punteggio da 0 a 100 valutandone la precisione l'esercizio.

Modalità C-1: premere il pulsante SELEZIONA per accedere all'interfaccia di impostazione dei parametri. Puoi regolare il numero di esercizi sessioni come richiesto (01-32). Il numero di sessioni per esercitarsi determina la durata di questo esercizio.

Modalità C-2: premere il pulsante SELEZIONA per accedere all'interfaccia di impostazione dei parametri. È possibile regolare il numero di sessioni di pratica secondo necessità (04-32). Il numero di sessioni di pratica determina la durata di questo esercizio.

Modalità C-3: premere il pulsante SELEZIONA per accedere all'interfaccia di impostazione dei parametri. È possibile regolare la velocità con cui il BPM modifiche (01-09 BPM).

5. Premere nuovamente il pulsante CLIC per terminare la modalità coach.

### 6 BRANI DIMOSTRATIVI

1. Premere il pulsante SONG per accedere alla modalità demo, ci sono 30 demo tra cui scegliere. Lo schermo visualizzerà la corrente numero del brano dimostrativo (01 -30).

2. Premere il pulsante  per avviare la riproduzione dei brani dimostrativi. Per interrompere la riproduzione, premere nuovamente il pulsante .

3. Girare la rotella dei parametri o premere i pulsanti +/- per selezionare una demo song.

4. Premere il pulsante SELECT in modalità canzone per passare all'interfaccia di impostazione dei parametri della canzone. È possibile attivare il suono della batteria o disattivo ruotando la rotella dei parametri (il suono della batteria è attivo per impostazione predefinita).

5. Premere il pulsante SELEZIONE per confermare e uscire dall'interfaccia dei parametri.

### 7 PARAMETRI DEL TAMBURO

1. Premere il pulsante KIT e lo schermo visualizzerà 01 (numero del kit di batteria). Premere SELECT per accedere al parametro della batteria modalità di regolazione.

2. Tocca il tamburo che desideri regolare, quindi premi i pulsanti +/- per selezionare il parametro da regolare. Sensibilità

A. S(01-06). Soglia di attivazione t(01 - 32).

Soglia di diafonia c (01 -32)

B. Trigger ripetuto r(01-32) Forza del tamburo

V(01-03). Volume del tamburo L (00 - 31).

3. Modificare i parametri ruotando la rotella dei parametri e premere a lungo il pulsante - per salvare. Lo schermo con display SAV per indicare che la regolazione del parametro è stata salvata con successo.

4. Per ripristinare i parametri del tamburo alle impostazioni di fabbrica, premere a lungo il pulsante + finché sullo schermo non viene visualizzato RES.

5. NOTA BENE: i parametri per i 3 tom non possono essere impostati individualmente.

### 8 FUNZIONE DI REGISTRAZIONE

1. Premere il pulsante < REC > quando l'indicatore luminoso è negli stati "KIT" e "CLICK" e lo schermo visualizza il parole "REC" nello stato lampeggiante di respirazione, entrando nello stato di preparazione della registrazione.

2. Tocca un tamburo qualsiasi e il metronomo suona. A questo punto, lo schermo visualizza "----" nello stato di respirazione lampeggiante e inizia a registrare.

3. Premere nuovamente il tasto < REC > o < PLAY >, la registrazione si interrompe e sullo schermo viene visualizzato "A-1".

4. Premere <  > per avviare la riproduzione della registrazione corrente e premere nuovamente per interrompere la riproduzione.

5. Se si entra nuovamente nello stato di preparazione della registrazione senza bussare, viene riprodotto il brano "A-1" registrato l'ultima volta.

### 9 SALVA/RESET

1. Per salvare i parametri premere a lungo il pulsante <-> e lo schermo visualizzerà SAV.

2. Per ripristinare i parametri, premere a lungo il pulsante <+> e lo schermo visualizzerà RES res.

### 10 MIDI USB

Per utilizzare la funzione MIDI del drum kit, collegare un cavo dati USB-B (non incluso con questo drum kit) all'unità di controllo e collegarlo al PC/Smartphone.



## APPENDICE

## Timbro

## Calcio .

- 1 . Pop Calcio
- 2 . Fanculo Calcio
- 3 . Calcio duro
- 4 . Calcio originale 5 .
- Calcio PopRock 6 .
- Calcio di roccia
- 7 . Calcio di metallo
- 8 . Calcio PowerMetal
- 9 . Calcio SpeedMetal 10 .
- Pop Jazz Kick 11 . Calcio jazz
- 12 . 808
- 13 . 909
- 14 . Songo Calcio 15 .
- Calcio standard
- 16 . Calcio acustico
- 17 . Calcio di visione
- 18 . Calcio moderno
- 19 . Calcio dei Blues
- 20 . Calcio classico
- 21 . Calcio Synthgaze 22 .
- Calcio strano
- 23 . Bastoni Calcio
- 24 . Calcio grunge 25 .
- Calcio degli anni '70
- 26 . Calcio degli anni '80
- 27 . Calcio popolare 28 .
- Calcio Slam
- 29 . Calcio d'attacco
- 30 . Vecchio calcio
- 31 . Calcio di Fairfax
- 32 . Calcio militare

## Rullante.

- 33 . Rullante pop 34 .
- Fanculo il rullante
- 35 . Rullante duro
- 36 . Rullante originale 37 .
- Rullante pop rock 38 .
- Rullante da roccia
- 39 . Rullante in metallo
- 40 . Rullante PowerMetal
- 41 . Rullante SpeedMetal 42 .
- Rullante PopJazz 43 .
- Rullante jazz
- 44 . 808
- 45 . 909
- 46 . Songo Snare 47 .
- Standard Snare
- 48 . Rullante acustico
- 49 . Rullante Seesion
- 50 . Rullante moderno
- 51 . Rullante Blues
- 52 . Rullante classico
- 53 . Rullante Synthgaze 54 .
- Strano rullante
- 55 . Rullante a bastoncini
- 56 . Rullante grunge 57 .
- Rullante anni '70
- 58 . Rullante anni '80
- 59 . Rullante popolare 60 .
- Rullante da sbattere
- 61 . Rullante d'attacco
- 62 . Vecchia trappola
- 63 . Rullante Fairfax
- 64 . Rullante Militare 65 .
- Cerchio del rullante pop
- 66 . Fanculo il bordo del rullante
- 67 . Cerchio rullante duro
- 68 . Cerchio del rullante originale
- 69 . Rima per rullante PopRock

- 70 . Cerchio del rullante Rock
- 71 . Cerchio per rullante in metallo
- 72 . Bordo del rullante PowerMetal
- 73 . Cerchio del rullante SpeedMetal
- 74 . Cerchio del rullante PopJazz
- 75 . Cerchio del rullante jazz
- 76 . 808
- 77 . 909
- 78 . Songo Snare Rim
- 79 . Cerchio del rullante standard
- 80 . Cerchio del rullante acustico
- 81 . Cerchio del rullante Seesion
- 82 . Cerchio del rullante moderno
- 83 . Cerchio del rullante Blues
- 84 . Cerchio del rullante classico
- 85 . Bordo del rullante Synthgaze
- 86 . Cerchio del rullante Freak
- 87 . Bastoncini per rullante
- 88 . Cerchio del rullante grunge
- 89 . Rullante Rim anni '70
- 90 . Rullante Rim anni '80
- 91 . Popolare bordo del rullante
- 92 . Cerchio del rullante Slam
- 93 . Attacco al rullante
- 94 . Vecchio bordo del rullante
- 95 . Cerchio per rullante Fairfax
- 96 . Cerchio per rullante militare

## Tom .

- 97 . Pop Tom1
- 98 . Fanculo Tom1
- 99 . Tom duro1
- 100 . Tom originale1
- 101 . PopRock Tom1
- 102 . Rock Tom1
- 103 . Tom di metallo1
- 104 . PowerMetal Tom1
- 105 . SpeedMetal Tom1
- 106 . PopJazz Tom1
- 107 . Jazz Tom1
- 108 . 808
- 109 . 909
- 110 . Songo Tom1
- 111 . Tom standard1
- 112 . Tom acustico1
- 113 . Consultazione Tom1
- 114 . Tom moderno1
- 115 . Blues Tom1
- 116 . Tom classico1
- 117 . Synthgaze Tom1
- 118 . Tom strano1
- 119 . Bastoni Tom1
- 120 . Grunge Tom1
- 121 . Tom1 degli anni '70
- 122 . Tom1 degli anni '80
- 123 . Tom popolare1
- 124 . Slam Tom1
- 125 . Attacca Tom1
- 126 . Vecchio Tom1
- 127 . Fairfax Tom1
- 128 . Tom militare1 129 .

- Pop Tom2
- 130 . Fanculo Tom2
- 131 . Tom duro2
- 132 . Tom2133 originale.
- PopRock Tom2

- 134 . Roccia Tom2
- 135 . Tom di metallo2
- 136 . PowerMetal Tom2
- 137 . SpeedMetal Tom2 138 .
- PopJazz Tom2
- 139 . Jazz Tom2
- 140 . 808
- 141 . 909
- 142 . Songo Tom2
- 143 . Tom standard2
- 144 . Tom acustico2
- 145 . Consultazione Tom2
- 146 . Tom moderno2
- 147 . Blues Tom2
- 148 . Tom classico2
- 149 . Synthgaze Tom2
- 150 . Il pazzo Tom2
- 151 . Attacca Tom2
- 152 . Grunge Tom2
- 153 . Tom2 degli anni '70
- 154 . Tom2 degli anni '80
- 155 . Tom2 popolare
- 156 . Slam Tom2
- 157 . Attacca Tom2
- 158 . Vecchio Tom2
- 159 . Fairfax Tom2
- 160 . Tom militare2 161 .
- Pop Tom3
- 162 . Fanculo Tom3
- 163 . Tom duro3
- 164 . Tom3 165 originale.
- PopRock Tom3
- 166 . Rock Tom3
- 167 . Tom di metallo3
- 168 . PowerMetal Tom3
- 169 . SpeedMetal Tom3 170 .
- PopJazz Tom3
- 171 . Jazz Tom3
- 172 . 808
- 173 . 909
- 174 . Songo Tom3
- 175 . Tom standard3
- 176 . Tom acustico3
- 177 . Consultazione Tom3
- 178 . Tom moderno3
- 179 . Blues Tom3
- 180 . Tom classico3
- 181 . Synthgaze Tom3
- 182 . Il pazzo Tom3
- 183 . Attacca Tom3
- 184 . Grunge Tom3
- 185 . Tom3 degli anni '70
- 186 . Tom3 degli anni '80
- 187 . Popolare Tom3
- 188 . Slam Tom3
- 189 . Attacca Tom3
- 190 . Vecchio Tom3
- 191 . Fairfax Tom3
- 192 . Tom militare3

## Incidente .

- 193 . Pop Crash1
- 194 . Fanculo Crash1
- 195 . Grave incidente1
- 196 . Crash originale1 197 .
- PopRock Crash1

- 198 . Schianto di rocco1
- 199 . Crash metallico1
- 200 . PowerMetal Crash1
- 201 . SpeedMetal Crash1 202 .
- PopJazz Crash1 203 . Jazz
- Crash1
- 204 . 808
- 205 . 909
- 206 . Songo Crash1 207 .
- Crash standard1
- 208 . Crash acustico1
- 209 . Seesion Crash1
- 210 . Crash moderno1
- 211 . Blues Crash1
- 212 . Crash classico1
- 213 . Synthgaze Crash1 214 .
- Strano incidente1
- 215 . Bastoni Crash1
- 216 . Grunge Crash1 217 .
- Crash degli anni '701
- 218 . Crash degli anni '801
- 219 . Popolare Crash1 220 .
- Slam Crash1
- 221 . Attacco Crash1
- 222 . Vecchio incidente1
- 223 . Incidente Fairfax1
- 224 . Incidente militare1 225 .
- Pop Crash1 Cerchio 226 .
- Fanculo Crash1 Rim
- 227 . Cerchio Hard Crash1
- 228 . Cerchio originale Crash1 229 .
- PopRock Crash1 Cerchio 230 .
- Rock Crash1
- 231 . Cerchio in metallo Crash1
- 232 . Cerchio PowerMetal Crash1
- 233 . Cerchio SpeedMetal Crash1 234 .
- PopJazz Crash1 Rim 235 .
- Jazz
- Crash1 Cerchio
- 236 . 808
- 237 . 909
- 238 . Songo Crash1 Cerchio 239 .
- Cerchio Crash1 standard
- 240 . Cerchio acustico Crash1
- 241 . Seesion Crash1 Rim
- 242 . Cerchio Crash1 moderno
- 243 . Blues Crash1 Rim
- 244 . Cerchio Crash1 classico
- 245 . Synthgaze Crash1 Rim 246 .
- Freak
- Crash1 Cerchio
- 247 . Bordo del giro strano
- 248 . Attacca Crash1 Rim
- 249 . Cerchio Grunge Crash1 249 .
- Crash1 Rim degli anni '70
- 250 . Crash1 Rim degli anni '80
- 251 . Popolare Crash1 Rim 252 .
- Cerchio Slam Crash1
- 253 . Attacca Crash1 Rim
- 254 . Vecchio bordo di Crash1
- 255 . Cerchio Fairfax Crash1
- 256 . Cerchio militare Crash1

## Passaggio .

- 257 . Giro pop 258 .
- Fanculo il giro
- 259 . Corsa dura
- 260 . Giro originale 261 .
- Giro pop-rock

- 262 . Giro sulla roccia
- 263 . Giro in metallo
- 264 . Corsa PowerMetal
- 265 . Giro in SpeedMetal
- 266 . Giro PopJazz
- 267 . Giro del jazz
- 268 . 808
- 269 . 909
- 270 . Songo Ride
- 271 . Giro standard
- 272 . Giro acustico
- 273 . Giro della visita
- 274 . Giro moderno
- 275 . Giro del Blues
- 276 . Giro classico
- 277 . Giro Synthgaze
- 278 . Giro strano
- 279 . Giro con i bastoncini
- 280 . Giro del grunge
- 281 . Giro degli anni '70
- 282 . Giro degli anni '80
- 283 . Giro popolare
- 284 . Giro di slam
- 285 . Giro d'attacco
- 286 . Vecchia cavalcata
- 287 . Giro di Fairfax
- 288 . Giro militare
- 289 . Bordo del giro pop
- 290 . Fanculo il giro sul bordo
- 291 . Cerchio da corsa dura
- 292 . Cerchio da corsa originale
- 293 . Rima di giro di PopRock
- 294 . Cerchio da giro sulla roccia
- 295 . Cerchione in metallo
- 296 . Cerchio PowerMetal
- 297 . Cerchio SpeedMetal Ride
- 298 . Cerchio PopJazz Ride
- 299 . Cerchio del giro del jazz
- 300 . 808
- 301 . 909
- 302 . Cerchio Songo Ride
- 303 . Cerchio da corsa standard
- 304 . Cerchio acustico
- 305 . Cerchio Seesion Ride
- 306 . Cerchio da corsa moderno
- 307 . Cerchio di giro dei blues
- 308 . Cerchio da corsa classico
- 309 . Synthgaze Ride Rim
- 310 . Bordo del giro strano
- 311 . Bastoni Ride Rim
- 312 . Cerchio da corsa grunge
- 313 . Giro in bici degli anni '70
- 314 . Giro in bici degli anni '80
- 315 . Cerchio da corsa popolare
- 316 . Cerchio Slam Ride
- 317 . Cerchio d'attacco
- 318 . Vecchio bordo della corsa
- 319 . Cerchio del giro di Fairfax
- 320 . Cerchio militare

## Ciao-Hat.

- 321 . Pop Hi-Hat aperto
- 322 . Fanculo il charleston aperto
- 323 . Hi-Hat duro aperto
- 324 . Hi-Hat originale aperto
- 325 . Hi-Hat PopRock aperto

- 326 . Rock Hi-Hat Aperto 327 .
- Hi-Hat in metallo aperto 328 .
- PowerMetal Hi-Hat aperto 329 .
- SpeedMetal Hi-Hat aperto 330 .
- PopJazz
- Hi-Hat Aperto 331 .
- Jazz Hi-Hat
- aperto
- 332 . 808
- 333 . 909
- 334 . Songo Hi-Hat Aperto 335 .
- Hi-Hat standard aperto 336 .
- Hi-Hat acustico
- aperto 337 .
- Seesion Hi-Hat Open 338 .
- Hi-Hat moderno aperto 339 .
- Blues
- charleston aperto 340 .
- Charleston
- classico aperto 341 .
- Synthgaze Hi-Hat
- Aperto 342 .
- Freak Hi-Hat Aperto
- 343 .
- Bacchette charleston aperte 344 .
- Charleston grunge aperto 345 .
- Hi-Hat
- anni '70 aperto 346 .
- Hi-Hat
- anni '80 aperto 347 .
- Popolare
- charleston aperto 348 .
- Slam
- charleston aperto 349 .
- Attacco
- Hi-Hat Aperto 350 .
- Vecchio charleston
- aperto 351 .
- Fairfax charleston
- aperto 352 .
- Charleston militare
- aperto 353 .
- Chiudi il charleston
- pop
- 354 .
- Fanculo il charleston, chiudi
- 355 .
- Chiusura dura del charleston
- 356 .
- Hi-Hat originale Chiudi 357 .
- Chiudi il charleston PopRock
- 358 .
- Rock Hi-Hat Chiudi
- 359 .
- Chiusura del charleston in metallo
- 360 .
- Chiudi il charleston PowerMetal
- 361 .
- SpeedMetal Hi-Hat Chiudi 362 .
- Chiudi il charleston PopJazz
- 363 .
- Chiusura del charleston jazz
- 364 .
- 808
- 365 .
- 909
- 366 .
- Songo Hi-Hat Chiudi
- 367 .
- Chiusura del charleston standard
- 368 .
- Chiusura del charleston acustico
- 369 .
- Chiusura della sessione Hi-Hat
- 370 .
- Chiusura moderna del charleston
- 371 .
- Chiusura del charleston blues
- 372 .
- Chiusura classica del charleston
- 373 .
- Chiudi il charleston Synthgaze
- 374 .
- Freak Hi-Hat Chiudi
- 375 .
- Attacca il charleston vicino
- 376 .
- Chiusura del charleston grunge
- 377 .
- Hi-Hat anni '70 Chiudi
- 378 .
- Chiudi il charleston degli anni '80
- 379 .
- Popolare Hi-Hat Chiudi
- 380 .
- Chiudi il charleston
- 381 .
- Attacco ravvicinato del charleston
- 382 .
- Vecchio charleston vicino
- 383 .
- Fairfax Hi-Hat Chiudi
- 384 .
- Charleston militare Chiudi 385 .
- Pedale del charleston pop
- 386 .
- Fanculo il pedale del charleston
- 387 .
- Pedale Hi-Hat rigido
- 388 .
- Pedale charleston originale 389 .
- Pedale charleston PopRock
- 390 .
- Pedale rock del charleston
- 391 .
- Pedale del charleston in metallo
- 392 .
- Pedale charleston PowerMetal
- 393 .
- Pedale charleston SpeedMetal 394 .
- Pedale del charleston PopJazz
- 395 .
- Pedale del charleston jazz
- 396 .
- 808
- 397 .
- 909
- 398 .
- Pedale del charleston Songo
- 399 .
- Pedale charleston standard
- 400 .
- Pedale del charleston PopRock



## APPENDIX

400 . Pedale acustico per charleston		433 . Seesion Crash2	450 . Fanculo Crash2Rim	467 . Blues Crash2 Rim
401 . Pedale Hi-Hat Seesion	417 . Pop Crash2	434 . Crash moderno2	451 . Cerchio Hard Crash2	468 . Cerchio classico di Crash2
402 . Moderno pedale del charleston	418 . Fanculo Crash2	435 . Blues Crash2	452 . Cerchio Crash2 originale	469 . Synthgaze Crash2 Rim
403 . Pedale charleston blues	419 . Crash duro2	436 . Crash classico2	453 . PopRock Crash2 Rima	470 . Freak Crash2 Rim
404 . Pedale charleston classico	420 . Crash originale2	437 . Synthgaze Crash2	454 . Cerchio Rock Crash2	471 . Attacca Crash2 Rim
405 . Pedale charleston Synthgaze	421 . PopRock Crash2	438 . Strano incidente2	455 . Cerchio in metallo Crash2	472 . Cerchio Grunge Crash2
406 . Freak pedale del charleston	422 . Schianto di rocce2	439 . Bastoni Crash2	456 . Cerchio PowerMetal Crash2	473 . Crash2 Rim degli anni '70
407 . Bacchette pedale charleston	423 . Schianto metallico2	440 . Crash del grunge2	457 . Cerchio SpeedMetal Crash2	474 . Crash2 Rim degli anni '80
408 . Pedale charleston grunge	424 . PowerMetal Crash2	441 . Crash degli anni '702	458 . PopJazz Crash2 Rim	475 . Popolare Crash2 Rim
409 . Pedale charleston anni	425 . SpeedMetal Crash2	442 . Crash degli anni '802	459 . Jazz Crash2 Cerchio	476 . Cerchio Slam Crash2
70 410 . Pedale charleston	426 . PopJazz Crash2	443 . Crash popolare2	460 . 808	477 . Attacco Crash2 Rim
anni '80 411 . Popolare pedale	427 . Jazz Crash2	444 . Slam Crash2	461 . 909	478 . Vecchio bordo di Crash2
charleston 412 . Pedale	428 . 808	445 . Attacco Crash2	462 . Songo Crash2 Rim	479 . Fairfax Crash2 Cerchio
charleston Slam 413 . Pedale Hi-	429 . 909	446 . Vecchio Crash2	463 . Cerchio Crash2 standard	480 . Cerchio militare Crash2
Hat d'attacco 414 . Vecchio	430 . Songo Crash2	447 . L'incidente di Fairfax2	464 . Cerchio acustico Crash2	
pedale del charleston 415 . Pedale	431 . Crash standard2	448 . Incidente militare2	465 . Seesion Crash2 Rim	
charleston Fairfax 416 . Pedale militare per il charleston	432 . Crash acustico2	449 . Cerchio Pop Crash2	466 . Cerchio moderno di Crash2	

schianto 2

### Drum combination timbre

01 Pop	09 VelocitàMetallo
02 Fanculo	10 PopJazz
03 Difficile	11 Jazz
04 Originale	12 808
05 Pop-Rock	13 909
06 Roccia	14 Songo
07 Metallo	15 Norma
08 PowerMetal	16 Acustica

### User drum group

17 Sessione	25 anni '70
18 Moderno	26 anni '80
19 Azzurri	27 Popolare
20 Classico	28 Sbattimento
21 Synthgaze	29 Attacco
22 Strano	30 vecchi
23 bastoncini	31 Fairfax
24Grunge	32 militare

### Demonstration music

Canzone 001	Canzone 007	Canzone 013	Canzone 019	Canzone 025
Canzone 002	Canzone 008	Canzone 014	Canzone 020	Canzone 026
Canzone 003	Canzone 009	Canzone 015	Canzone 021	Canzone 027
Canzone 004	Canzone 010	Canzone 016	Canzone 022	Canzone 028
Canzone 005	Canzone 011	Canzone 017	Canzone 023	Canzone 029
Canzone 006	Canzone 012	Canzone 018	Canzone 024	Canzone 030



## MANUTENZIONE DEL PRODOTTO

Un'attenta manutenzione e protezione di questo prodotto svolgono un ruolo molto importante nel prolungare la durata del prodotto e nel ridurre i guasti.

#### 1 Evitare fonti di calore, umidità o luce solare diretta

Non esporre eccessivamente il prodotto alla luce solare diretta, né posizionarlo vicino al condizionatore d'aria o a un luogo estremamente caldo.

#### 2 Non utilizzare vicino a TV o radio

Questo prodotto può causare interferenze video o audio alla ricezione di TV e radio. In tal caso, rimuovere il prodotto dalla TV o dalla radio.



## MANUTENZIONE DEL PRODOTTO

### 3 Non utilizzare vernici, diluenti o prodotti chimici simili per la pulizia

Utilizzare un panno morbido e privo di sporco imbevuto di una piccola quantità di acqua o detergente speciale per pulire le macchie superficiali di questo prodotto.

### 4 Non agitare per evitare collisioni

Il prodotto deve essere maneggiato con cura durante lo spostamento. Sono severamente vietate vibrazioni violente e collisioni per evitare danni al guscio o ai componenti elettronici interni.



## SAFETY PRECAUTIONS

### POWER SUPPLY

This product can be powered by standard indoor wall sockets. Please only use the power cord specified in this product. When not in use, please turn off the power supply. When not in use for a long time, pull out the power cord and keep it properly.

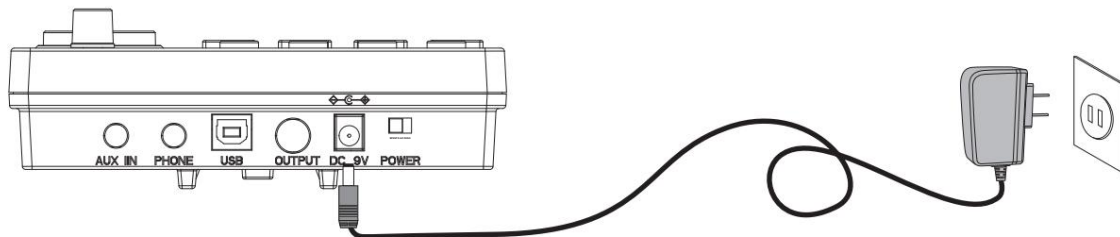

### SIGN

To ensure that you use this product safely and correctly, to prevent harm to users and others and financial damage, this manual and products are marked with a series of safety signs. The various signs and their meanings are as follows:

#### **WARNING**

This sign indicates that there is a potential risk of death or serious injury if this mark is ignored and the product is mishandled.

#### **BE CAREFUL**

This sign indicates that there is a potential danger of injury to personnel or other financial damage if this sign is ignored and the product is operated incorrectly.

### EXAMPLE OF LOGO



This triangle sign ( $\Delta$ ) indicates what users should pay attention to. (The left example is careful shocks)



A circular sign ( $\ominus$ ) with an oblique line indicates prohibitions. The icons in or beside the logo indicate the contents specifically prohibited. (The example on the left is no disassembly)



The round black bottom sign ( $\oplus$ ) indicates what must be observed. The diagrams in this sign indicate the contents of the specific matters that must be observed. (The example on the left is that the power plug must be pulled out of the socket)



## SAFETY PRECAUTIONS

### **WARNING**

#### **Smoke, odor, overheating**

When the product smokes, smells or overheats, there is a danger of fire and electric shock when it is used continually. In case of the above situation, the following operations should be performed immediately:

1. Turn off the power supply.
2. Pull the plug out of the power outlet.
3. Contact your dealer.

#### **Power cord**

1. The improper use of power cord may cause fire and electric shock. The following precautions must be observed:
  - The special power cord designated for this product must be used.
  - The AC power supply with output voltage within the rated voltage range for household use must be used.
  - Do not overload power sockets and extension lines.
2. The improper treatment of power line will lead to its damage or breakage, which will cause fire and electric shock hazards. The following precautions must be observed:
  - Do not place or heat heavy objects on power lines.
  - Do not attempt to alter or bend the power cord too much.
  - Do not twist or pull the power cord.
  - If the power cord or plug is damaged, please replace the same type of power cord.
3. Do not touch the power cord and plug with wet hands, otherwise there is a danger of electric shock.
4. Please use the power cord where the water will not splash. Water is in danger of causing fire and electric shock.
5. Never place vases or any other container containing water on this product. Water is dangerous of causing fire and electric shock.
6. Do not allow minors to unplug and touch power lines or connection boards. Minors have no common sense of electricity safety, which may cause electric shock.

### **BE CAREFUL**

The improper use of power cord may cause fire and electric shock. The following precautions must be observed:

- Never put the power cord near the oven or other heat source.
- Do not pull the cable when pulling out of the power socket. The main body of the plug must be grasped.
- The power cord plug must be inserted in the socket to the end.
- Make sure the power supply is off before connecting or disconnecting it.
- When thunderstorms occur or before traveling or other long-term departure, disconnect the power cord from the wall outlet.
- At least once a year, remove the power cord from the wall outlet and clean the dust accumulated around the plug.

#### **Do not burn this product**

Do not put this product in the fire, otherwise it will lead to product combustion and explosion of internal electronic components, which will cause fire and personnel injury.

#### **Water and foreign bodies**

Water, other liquids and (metal sheets, etc.) entering this product are in danger of causing fire and electric shock. In case of the above situation, the following operations shall be performed immediately:

1. Turn off the power supply.
2. If you are using a power cord for power supply, unplug it from the wall outlet.
3. Contact your distributor.

#### **Disassembly and transformation**

Do not disassemble or transform the product in any way, otherwise there is a risk of electric shock, scald or other personal injury. All internal inspection, adjustment and maintenance operations should be entrusted to your distributor.



## SAFETY PRECAUTIONS

### Falling or colliding

If the product falls or is damaged by strong impact, it will be in danger of causing fire and electric shock. In case of the above situation, the following operations shall be performed immediately:

1. Turn off the power supply.
2. If you are using a power cord for power supply, you need to unplug it from the wall outlet.
3. Contact your distributor.



### Plastic bag

Do not let anyone put plastic bags for this product on his head or in his mouth. Otherwise, there is a risk of asphyxia. Families with young children should pay special attention to it.



### Keep a distance from the product and the bracket

Climbing the bracket is dangerous of overturning or damage. Families with young children should pay special attention to it.



### Put

Avoid placing the product on an uneven surface or any other unstable place. Otherwise, it will cause the product to fall down, which will lead to the risk of injury.



### Product Mobility

Before moving this product, you must unplug the power cord plug from the wall outlet and pull out all other cables and connecting wires. Otherwise, it will lead to damage of power or connection wires, resulting in fire and electric shock.



### clean

Before cleaning this product, you must unplug the power cord plug from the wall outlet, otherwise there is a risk of fire and electric shock.



### Jack

The socket of this product can only be connected to the designated equipment and devices. Connecting non-designated equipment or devices is dangerous of causing fire and electric shock.



### Location selection

It should be avoided to place the product in the following places, otherwise there is a risk of fire and electric shock.



- High temperature or dusty places.
- Kitchen or other places with lampblack.
- Where the product is exposed to direct sunlight, or any other place where the product will produce high temperature.

### Volume

Don't play music long and loud. Pay special attention when using headphones. Excessive volume can damage your hearing.



### Heavy



Do not place heavy objects on this product. Otherwise, the top of the product will be overweight, causing the product to overturn or drop objects on it, which will lead to the risk of injury.



### Correct assembly of scaffolds

The incorrect assembly of the bracket may overturn, causing the product to fall off and posing a risk of injury to personnel. Therefore, it must be assembled according to the instructions in the attached installation guide to ensure that the product is properly mounted on its bracket.



	<p>Avvertenza: per ridurre il rischio di lesioni, l'utente deve leggere attentamente il manuale di istruzioni.</p>
	<p>Questo dispositivo è conforme alla Parte 15 delle norme FCC. Il funzionamento è soggetto alle seguenti due condizioni: (1) Questo dispositivo non può causare interferenze dannose e (2) questo dispositivo deve accettare qualsiasi interferenza ricevuta, comprese le interferenze che potrebbero causare un funzionamento indesiderato.</p>
	<p>Questo prodotto è soggetto alle disposizioni della Direttiva Europea 2012/19/CE. Il simbolo del bidone della spazzatura barrato indica che nell'Unione Europea il prodotto richiede la raccolta differenziata dei rifiuti. Ciò vale per il prodotto e tutti gli accessori contrassegnati da questo simbolo. I prodotti contrassegnati come tali non possono essere smaltiti con i normali rifiuti domestici, ma devono essere portati in un punto di raccolta per il riciclaggio di dispositivi elettrici ed elettronici</p>

**Produttore:** Shanghaimuxinmuyeyouxiangongsi

**Indirizzo:** Shuangchenglu 803nong11hao1602A-1609shi, baoshanqu, shanghai 200000 CN.

**Importato in AUS:** SIHAO PTY LTD, 1 ROKEVA STREETEASTWOOD NSW 2122Australia

**Importato negli Stati Uniti:** Sanven Technology Ltd., Suite 250, 9166 Anaheim Place, Rancho Cucamonga, CA 91730



E-CrossStu GmbH

Mainzer Landstr.69, 60329 Francoforte sul Meno.

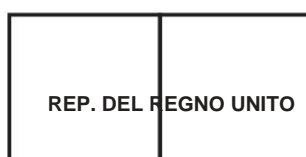

YH CONSULENZA LIMITATA.

C/O YH Consulting Limited Ufficio 147, Centurion House, London Road, Staines-upon-Thames, Surrey, TW18 4AX



**VEVOR<sup>®</sup>**

**TOUGH TOOLS, HALF PRICE**

**Supporto tecnico e certificato di garanzia  
elettronica [www.vevor.com/support](http://www.vevor.com/support)**

# VEVOR<sup>®</sup>

## TOUGH TOOLS, HALF PRICE

Soporte técnico y certificado de garantía

electrónica [www.vevor.com/support](http://www.vevor.com/support)

### BATERÍA ELECTRÓNICA

### MANUAL DE USUARIO

MODELO: MD200F-P

Seguimos comprometidos a proporcionarle herramientas a precios competitivos.

"Ahorre a mitad de precio", "A mitad de precio" o cualquier otra expresión similar utilizada por nosotros solo representa una estimación de los ahorros que podría beneficiarse al comprar ciertas herramientas con nosotros en comparación con las principales marcas principales y no significa necesariamente que cubra todas las categorías de herramientas. ofrecido por nosotros. Le recordamos que, cuando realice un pedido con nosotros, verifique cuidadosamente si realmente está ahorrando la mitad en comparación con las principales marcas.

# VEVOR<sup>®</sup>

TOUGH TOOLS, HALF PRICE

BATERÍA ELECTRÓNICA

MODELO: MD200F-P F

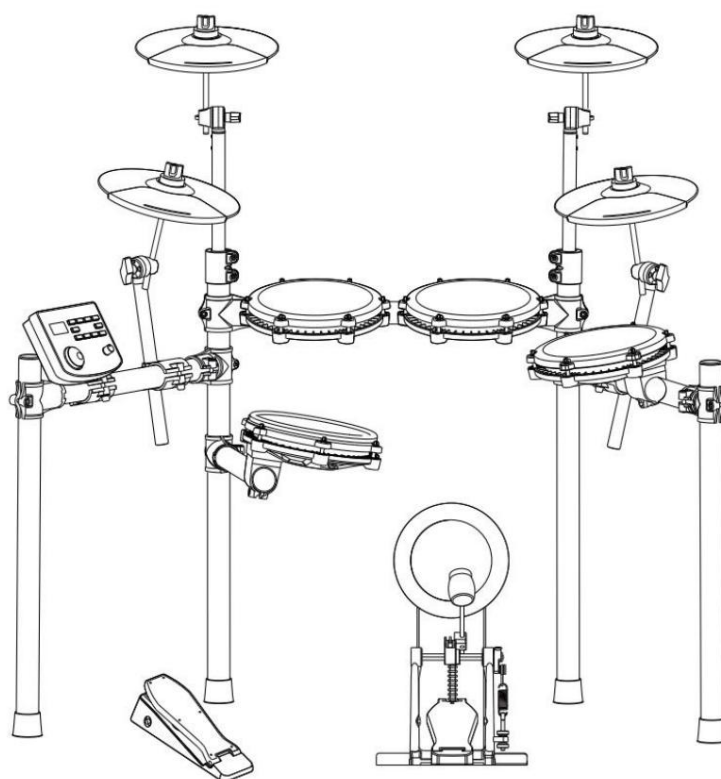

(La imagen es solo de referencia, consulte el objeto real )

¿NECESITAS AYUDA? ¡CONTÁCTENOS!

¿Tiene preguntas sobre el producto? ¿Necesita soporte técnico? Por favor, siéntase libre de contáctenos:

Soporte Técnico y Certificado de Garantía Electrónica

[www.vevor.com/support](http://www.vevor.com/support)

Estas son las instrucciones originales; lea atentamente todas las instrucciones del manual antes de operar. VEVOR se reserva una interpretación clara de nuestro manual de usuario. La apariencia del producto estará sujeta al producto que recibió. Perdón que no le informaremos nuevamente si hay actualizaciones de tecnología o software en nuestro producto.



## INTRODUCCIÓN A LA FUNCIÓN

Gracias por elegir nuestra batería electrónica. El tambor electrónico elegante y delicado es la combinación perfecta de nueva tecnología electrónica moderna. •Antes de utilizar este producto, debe leer detalladamente las instrucciones.

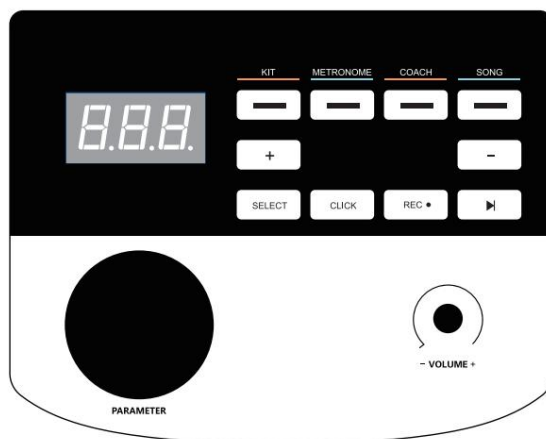

- 32 juegos de batería, 480 timbres
- 30 canciones
- Admite el ajuste de los parámetros de sensibilidad de cada tambor.
- Tres modos de enseñanza
- Control de velocidad: 30 ~ 250 latidos/min
- Metrónomo: 1-9 tipos
- Otras funciones: almacenamiento, reinicio y grabación de parámetros;
- pantalla LED de tres dígitos;
- interfaz: fuente de alimentación dc, usbmidi, auricular, entrada de audio, salida de audio

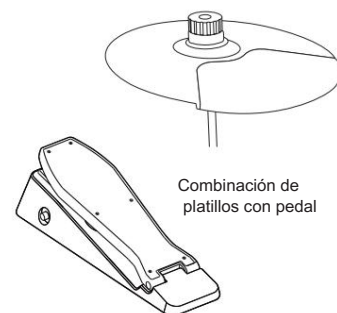
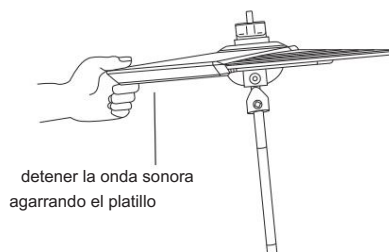
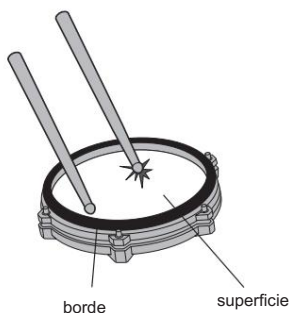

### ¡OBSERVACIÓN!

- Este producto es un instrumento electroacústico. Es normal que haya un pequeño sonido en el altavoz o auricular después del encendido.

Manténgalo alejado de "radio, TV, receptor de antena, enrutador, refrigerador, TV, motor y otras fuentes de interferencia eléctrica de RF" durante el uso.

**CONTENIDO**

INTRODUCCIÓN A LA FUNCIÓN	1
CONTENIDOS	2
GUÍA DE INSTALACIÓN	3
COMPRUEBE LOS ARTÍCULOS ADJUNTOS	3
SOPORTE DE TUBO DE LRON	4
INTUBACIÓN TIMPÁNICA	4
SOPORTE DE MONTAJE	5
INSTALE EL MÓDULO DE TAMBOR	5
INSTALE LAS PIEZAS DE GOLPEO Y EL MÓDULO DE SONIDO	6
INSTALE EL TAMBOR	7
INSTALE LA BARRA DEL MARTILLO	7
EL KICK DRAMBOR SE FIJA CON EL STEP HAMMER	7
ENCHUFAR EL CABLE DE CONEXIÓN DE LA PIEZA DE PEGADO	7
ILUSTRACIÓN DEL PUERTO DEL MÓDULO DE SONIDO	8
CONEXIÓN DEL CABLE DE ALIMENTACIÓN	8
PUERTO USB MIDI	8
PUERTO DE SALIDA DE AUDIO	8
PUERTO DE ENTRADA DE AUDIO	8
PUERTO PARA AURICULARES	8
AUMENTAR PUERTO	8
MODO BT	8
MANUAL DE OPERACIONES	9
FUERZA	9
SELECCIÓN DEL KIT DE BATERÍA	9
METRÓNOMO	9
FUNCIÓN DE PRÁCTICA	9
MODO ENTRENADOR	9
CANCIONES DE DEMOSTRACIÓN	10
PARÁMETROS DEL TAMBOR	10
FUNCIÓN DE GRABACIÓN	10
GUARDAR/RESETABLECER	10
USB-MIDI	11
APÉNDICE	11
TIMBRE	11
KITS DE BATERÍA PREAJUSTADOS	11
KITS DE BATERÍA DEFINIDOS POR EL USUARIO	11
CANCIÓN DE DEMOSTRACIÓN	11
MANTENIMIENTO DEL PRODUCTO	12
PRECAUCIONES DE SEGURIDAD	13



# GUÍA DE INSTALACIÓN

## ¡OBSERVACIÓN!

- Siga las instrucciones y lea atentamente las "precauciones de seguridad" del Manual del usuario. antes de usar.
- Este producto debe ser instalado por un adulto, no permita que un menor lo instale de forma independiente.

# 01

## Consulta los elementos adjuntos

- Después de abrir el paquete, verifique inmediatamente si contiene todos los artículos. Si hay alguna omisión, comuníquese con su distribuidor.



módulo de sonido



Soporte del módulo



Platillo \*4

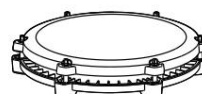

Tom (3 piezas)



Trampa



Soporte trasero



Soporte de conexión



Soporte delantero



Patada

2 piezas 2 piezas 6 piezas



tornillo

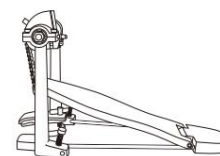

pedal de patada



brazo de platillo  
(4 piezas)

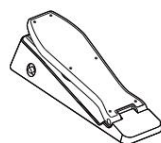

Hola pedal del sombrero



Destornillador



Cable de conexión de señal



tecla de tambor



Adaptador de corriente



baqueta



Martillo de palo



## PLANO DE CONJUNTO

### 02

#### soporte de tubo de hierro

•El soporte se encuentra en un pequeño paquete individual dentro de la caja.

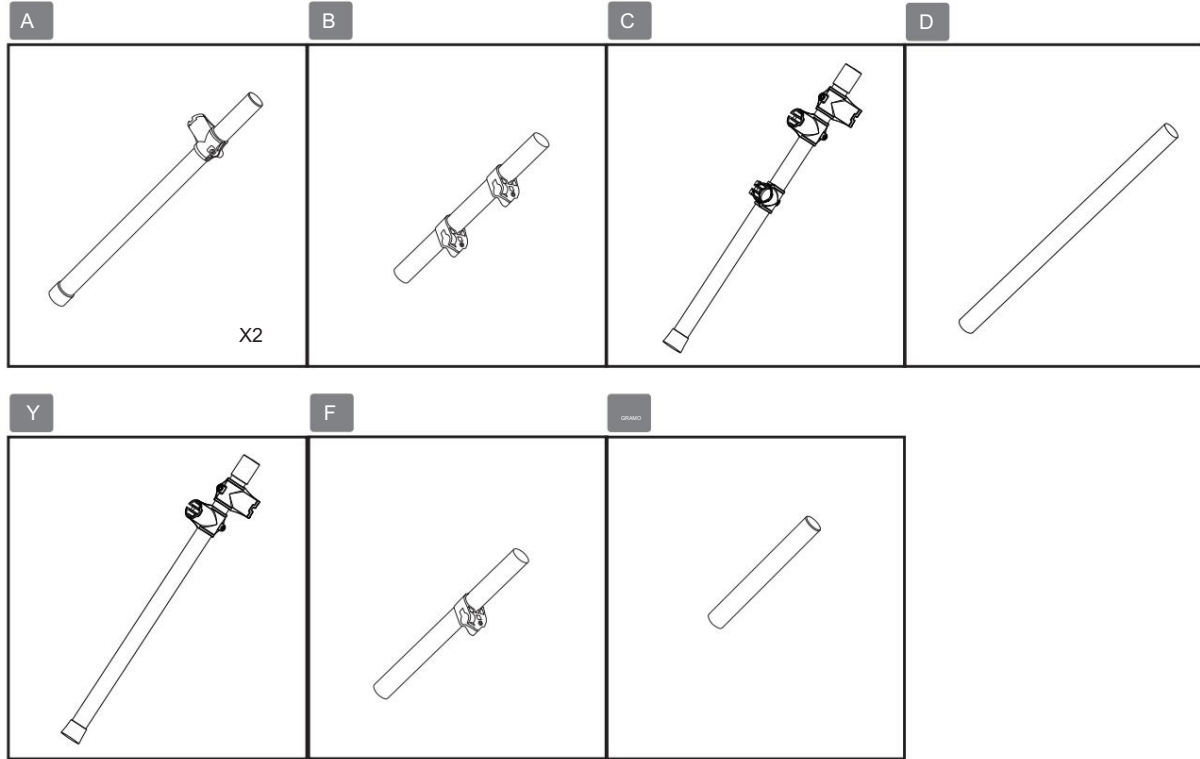

### 03 Intubación timpánica

Instale el tambor en la barra de soporte del tambor.

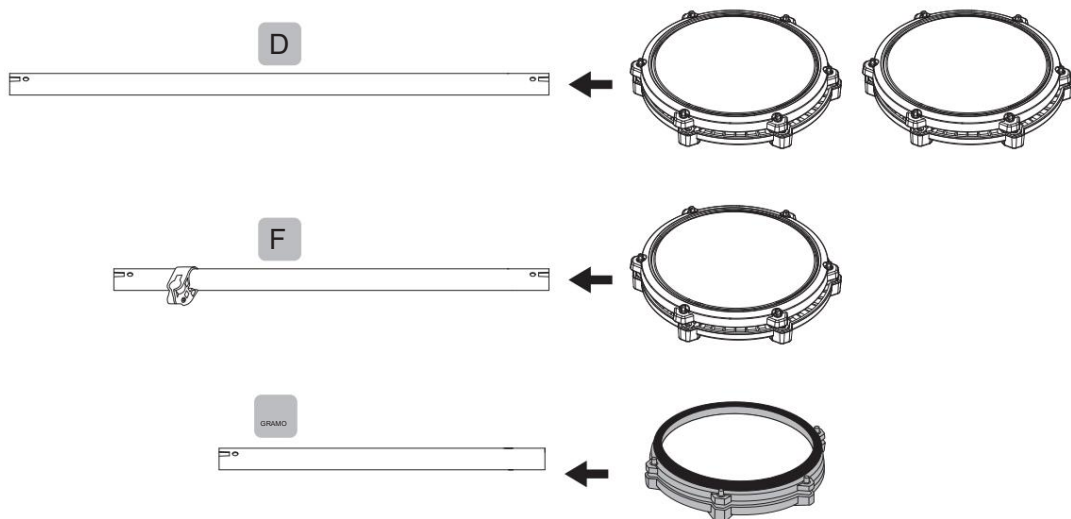



## GUÍA DE INSTALACIÓN

### 04

#### Soporte de montaje

- Durante la instalación, apriete los tornillos y tenga cuidado de pillarse los dedos.
- Ensamble el soporte en la dirección especificada

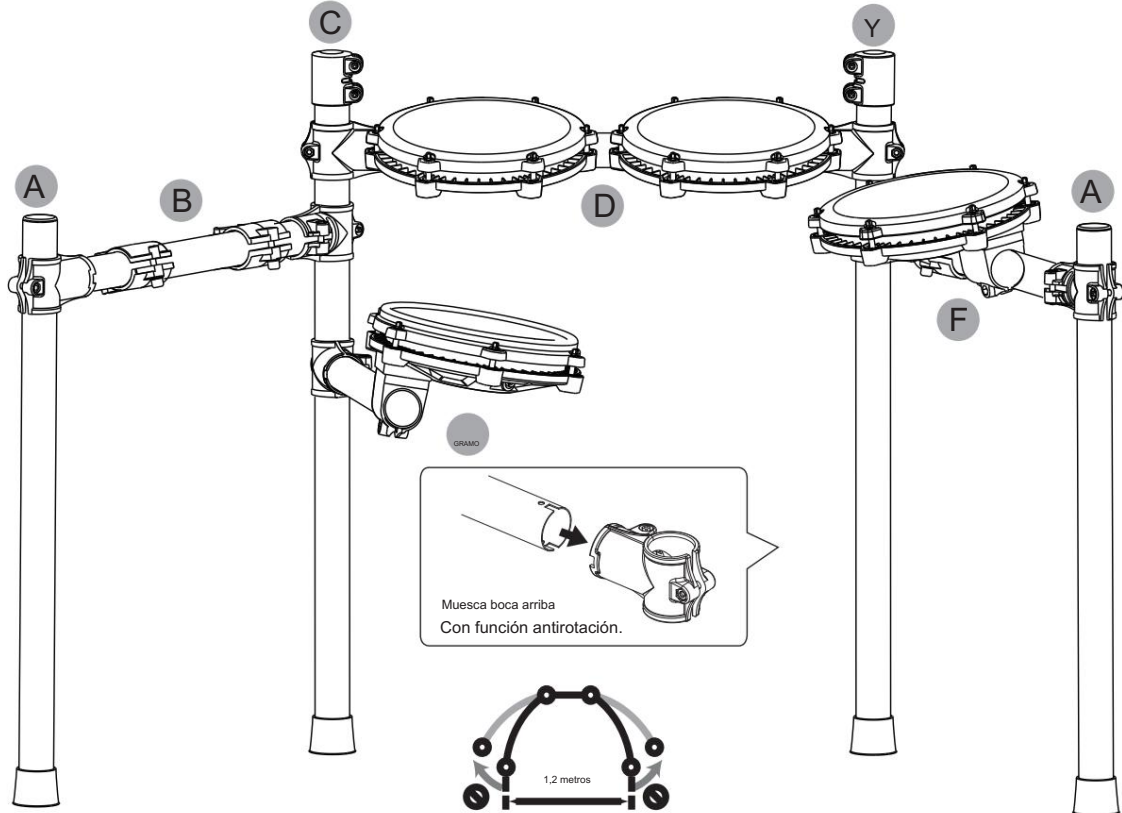

Por motivos de seguridad, el ancho de expansión del soporte no debe ser superior a 1,2 metros.

### 05

#### Instalar el módulo de batería

- Insértelo en su lugar durante el montaje.

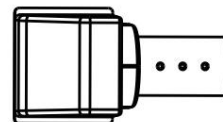
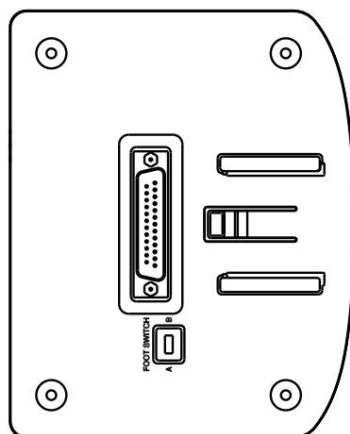

Alinee el módulo de batería del mainframe con el riel de la caja del mainframe e insértelo. Después de insertarlo hasta el fondo, podrá escuchar cómo aparecen las piezas a presión.



06

## Instalar piezas de golpe y módulo de sonido.

- Apriete los tornillos después de insertar el tambor para evitar que se aflojen.
- Asegúrese de no apretar demasiado el platillo, deje algo de espacio para que se muevan hacia arriba y hacia abajo.

Retire las tuercas y las almohadillas circulares del brazo de tres platillos, coloque los tres platillos en el brazo correspondiente y atornille las tuercas. Coloque 3 tambores y 1 tambor en la varilla de soporte correspondiente respectivamente y apriete los tornillos.

Nota: las funciones de cada platillo, tom y caja son diferentes, por lo que es necesario consultar la identificación de accesorios para una correcta instalación.

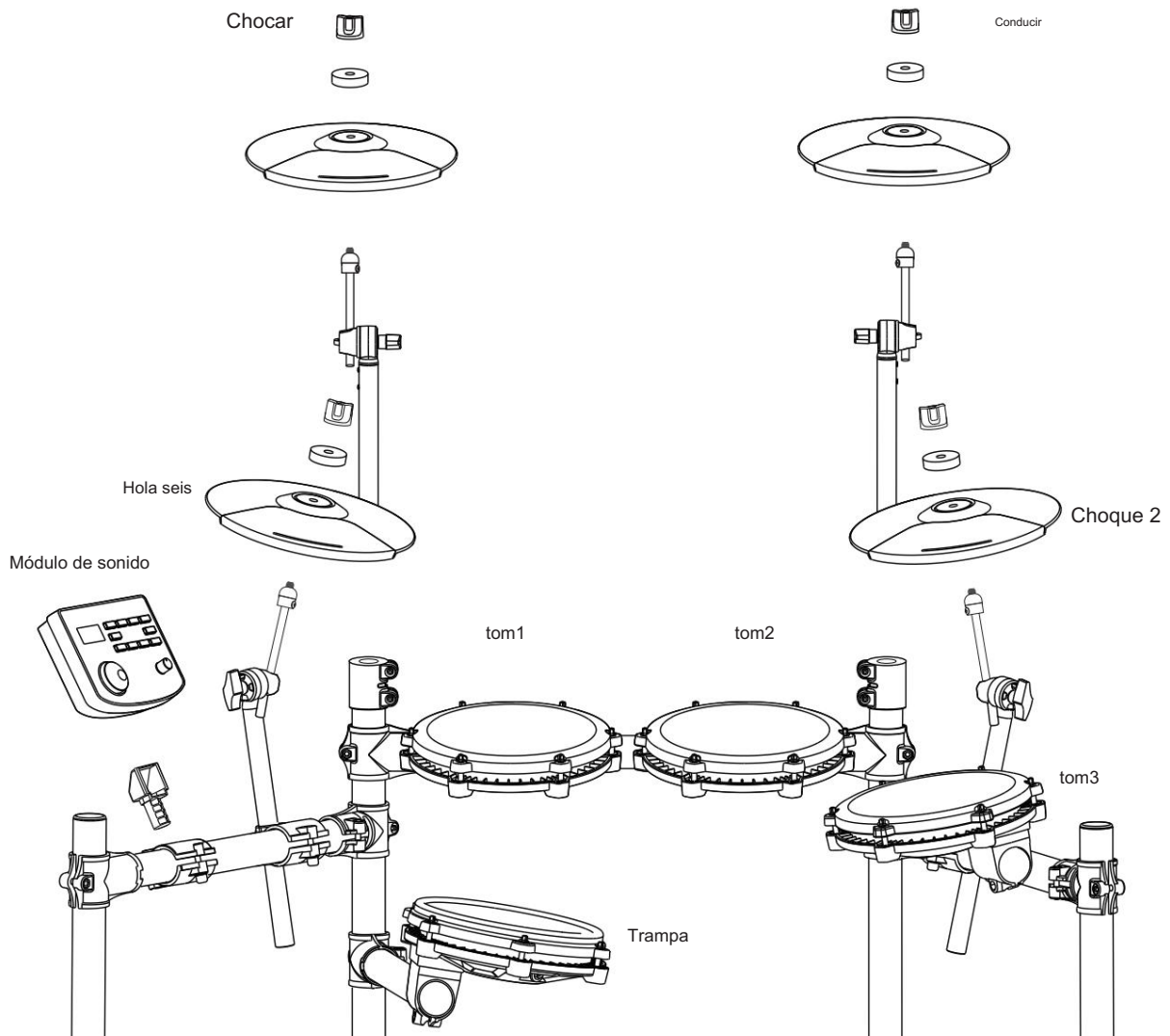



## GUÍA DE INSTALACIÓN

### 07

#### Instalar el bombo

- durante la instalación, apriete los tornillos y tenga cuidado de no pillarse los dedos.

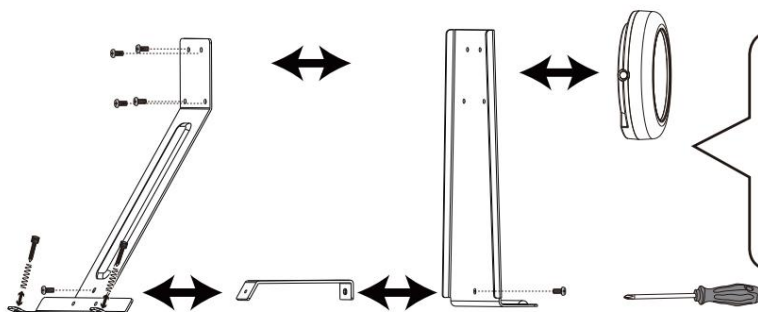

Utilice un destornillador para fijar el tambor inferior y las fijaciones como se muestra. piezas de soporte con 6 tornillos pequeños. Luego coloque 2 resortes en 2 tornillos antideslizantes y bloquee los 2 resortes en la parte inferior de la pieza de soporte hasta que descance en el suelo.

### 08

#### Instale la barra de martillo

- el poste debe insertarse en encaje y los tornillos deben apretarse para evitar que se aflojen.

Inserte la varilla del martillo en el orificio redondo, como se muestra en la figura, gire el martillo de lana para alinearlos con la superficie del tambor, y luego apriételo con la llave del tambor.

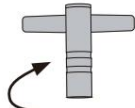

Inserte la barra de hierro fija en el agujero, como se muestra en la figura.

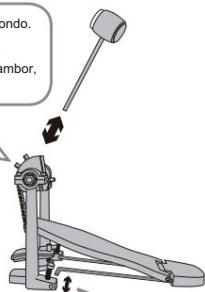

### 09

#### El bombo se fija con el martillo paso a paso

- el tambor inferior y el martillo escalonado deben estar fijos y apretado para evitar que se caiga.

Inserte el borde sobresaliente del tambor bajo en el clip de fijación del martillo como se muestra en la figura y apriete los tornillos.

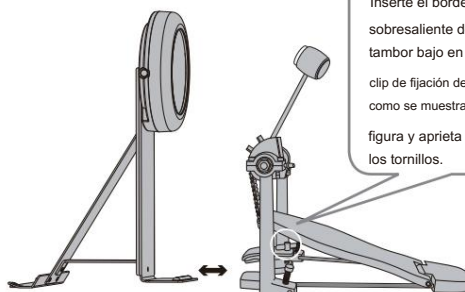
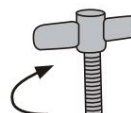

### 10

#### Conecte el cable de conexión de la pieza de percusión.

- Inserte el cable de conexión en su lugar para evitar un mal contacto e insértelo correctamente como se muestra en el diagrama.

Compruebe si el tambor inferior emite sonido. Si no hay sonido, gire el interruptor:  
Cambiar en A: modo bombo mecánico  
Cambiar en B: modo pedal.

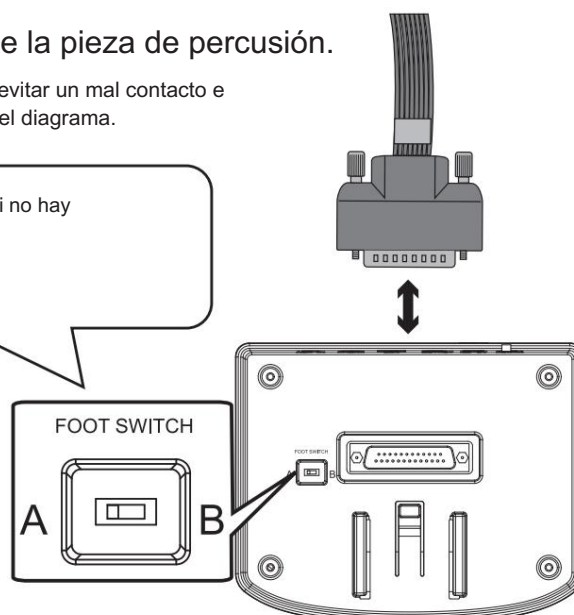



## ILUSTRACIÓN DEL PUERTO DEL MÓDULO DE SONIDO

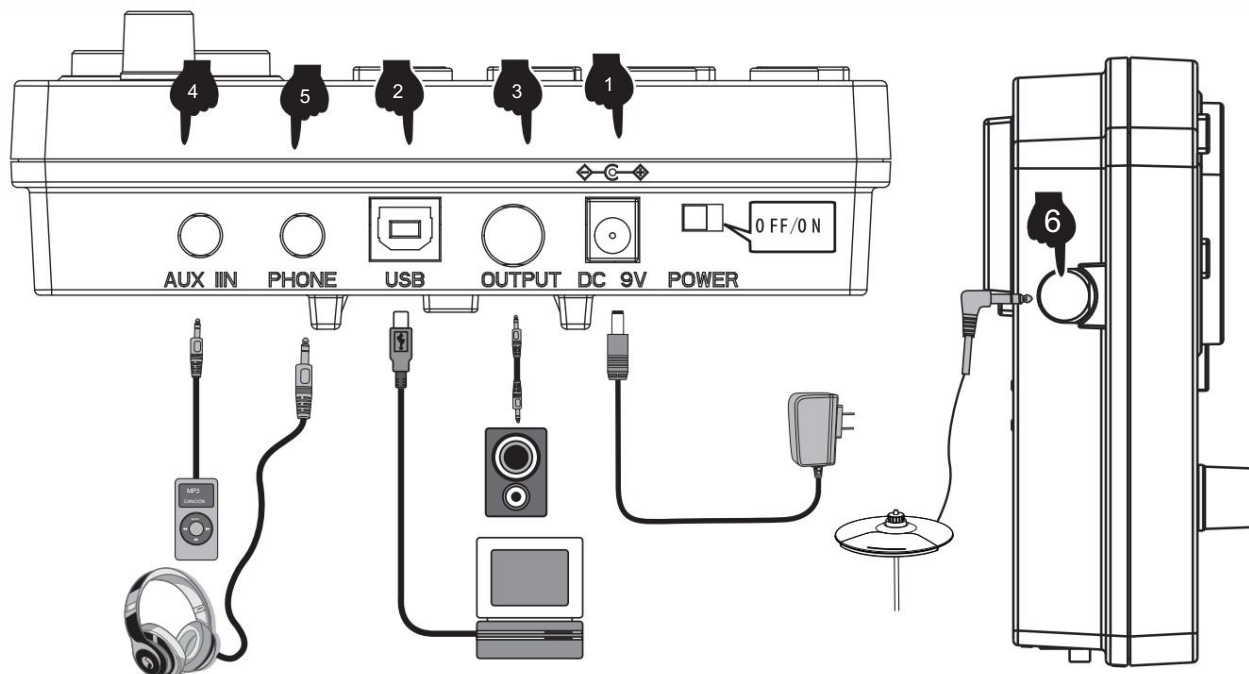

### 1 CONEXIÓN DEL CABLE DE ALIMENTACIÓN

1. Cuando esté en uso, conecte el terminal de alimentación de acuerdo con el diagrama, inserte la toma de corriente del módulo de sonido en un extremo y toma de corriente doméstica de 100-240V en el otro extremo. (Figura 1)
2. Si no utiliza este producto durante un período prolongado, desconecte el enchufe y manténgalo correctamente.

### 2 PUERTOS USB-MIDI

El uso de la interfaz USB MIDI de batería electrónica puede interactuar con dispositivos de música con MIDI.

1. A través del software de Música preinstalado en computadoras y teléfonos móviles, podemos aprender a tocar, componer música, tienda y otras funciones. (Figura 2)
2. Cuando se conecta a una computadora o teléfono móvil, la salida de audio del dispositivo debe conectarse a la toma de entrada de audio de la caja del módulo para sincronizar los efectos de sonido en el dispositivo. (Figura 5)

### 3 PUERTOS DE SALIDA DE AUDIO

El puerto de salida de audio se puede conectar con un altavoz activo (altavoz de batería electrónica especial) y un equipo de audio grande. (Fig. 3)

### 4 PUERTOS DE ENTRADA DE AUDIO

El puerto de entrada de audio puede conectar el dispositivo de reproducción de fuente de sonido a la caja del módulo para su reproducción (como MP3. Teléfono móvil y otra entrada de señal de audio). (Figura 4)

### 5 PUERTO PARA AURICULARES

La conexión de auriculares monitorea los detalles de la percusión y no molesta a los demás cuando tocan sin conectarse Altavoces. (Figura 5)

### 6 AUMENTAR PUERTO

Este puerto le permite agregar un platillo para una fácil expansión. (Figura 6)



## MANUAL DE OPERACIONES

### 1 POTENCIA

Inserte el enchufe de CC en el puerto CC de 9 V en la parte superior de la unidad de control. Deslice el interruptor POWER hacia la derecha (visto desde la parte delantera) para encender la batería. Para apagar la batería, deslice el interruptor hacia la izquierda.

### SELECCIÓN DE 2 BATERÍAS

Presione el botón KIT para mostrar el kit de batería actual. Gire la rueda de parámetros o utilice los botones <- /+> para seleccionar el parámetro deseado. kit de batería. Hay 32 kits de batería para elegir; consulte la lista de kits de batería en la página 11.

### 3 METRÓNOMO

1. Presione el botón METRONOME para ingresar al modo metrónomo.
2. La pantalla mostrará el valor de velocidad (velocidad predeterminada de 120 BPM). Gire la rueda de parámetros o utilice los botones +/- para cambiar la velocidad del metrónomo. Presione el botón CLICK para iniciar el metrónomo.
3. Presione el botón SELECT en el modo metrónomo y la pantalla saltará al ajuste de parámetros del metrónomo.
 

Interfaz. Puede presionar los botones +/- para seleccionar el parámetro que desea ajustar:

  - A. r (tipo de ritmo: 2,4,8,16)
  - B. b (número de tiempo: 01-09)
  - C. L (volumen del metrónomo: 00 (apagado) -31) y luego gire la rueda de parámetros para ajustar la configuración de los parámetros.
4. Una vez que se hayan ajustado los parámetros, presione el botón SELECCIONAR para confirmar y salir de la interfaz de parámetros. Luego utilice el botón CLIC para iniciar y detener el metrónomo como desee.

### 4 FUNCIÓN DE PRÁCTICA

El modo "entrenador" de este producto puede ayudar a establecer velocidad, precisión y resistencia, y ayudar a cultivar la función de práctica de un mejor sentido del ritmo. ¡Avanza bajo la supervisión del modo entrenador "entrenador"!

Presione el botón "entrenador" para ingresar al modo entrenador. En este modo, hay tres modos de práctica. Seleccione la práctica modo a través de la rueda de datos o el botón <+ > <- >.

1. Modo de ejercicio 1: Ejercicio de detección de ritmo C-1: golpea el tambor a una velocidad fija para entrenar la precisión del golpe.
2. Modo de práctica 2: Modo de golpe silencioso C-2: el metrónomo hará sonar una sección y silenciará una sección para entrenar el
 

Precisión del golpe sin aviso de metrónomo. Es una versión avanzada del modo de práctica 1.
3. Modo de práctica 3: práctica de golpe de velocidad C-3, el metrónomo cambiará automáticamente la velocidad, aumentará desde el expreso más lento al más rápido, y luego reduzca del expreso más lento a la velocidad más lenta, de modo que para practicar la resistencia al golpe.

### 5 MODO ENTRENADOR

1. El modo de entrenamiento "entrenador" de este producto puede ayudar a establecer velocidad, precisión y resistencia. Presione el botón COACH para ingresar al modo entrenador. En este modo, hay tres modos de práctica. Utilice la rueda de parámetros para seleccionar qué modo de práctica.
  - A. Modo de ejercicio 1: Ejercicio de detección de ritmo C-1: golpee el tambor a una velocidad fija para entrenar la precisión del golpe.
  - B. Modo de práctica 2: modo de golpe silencioso C-2: el metrónomo sonará una sección y silenciará una sección para entrenar cuando no hay ritmo.
  - C. Modo de práctica 3: Práctica de golpe de velocidad C-3: el metrónomo cambiará automáticamente la velocidad desde la más lenta al más rápido y luego del más rápido al más lento.
2. Una vez elegido el modo de entrenamiento, presione el botón CLIC. Los ritmos del metrónomo comenzarán y podrá
 

Toque el tambor para practicar.
3. Después de cuatro latidos preliminares, la pantalla mostrará:

(demasiado lento)



(bien)



(demasiado rapido)





## MANUAL DE OPERACIONES

- Una vez que haya completado el modo de entrenamiento, se mostrará una puntuación de 0 a 100 que evalúa la precisión de el ejercicio.

Modo C-1: Presione el botón SELECT para ingresar a la interfaz de configuración de parámetros. Puedes ajustar el número de prácticas. sesiones según sea necesario (01-32). El número de sesiones a practicar determina la duración de este ejercicio.

Modo C-2: Presione el botón SELECT para ingresar a la interfaz de configuración de parámetros. Puede ajustar el número de sesiones de práctica según sea necesario (04-32). El número de sesiones a practicar determina la duración de este ejercicio.

Modo C-3: Presione el botón SELECT para ingresar a la interfaz de configuración de parámetros. Puede ajustar la velocidad a la que se reproducen los BPM. cambios (01-09 BPM).

- Presione el botón CLICK nuevamente para finalizar el modo entrenador.

### 6 CANCIONES DE DEMOSTRACIÓN

- Presione el botón SONG para ingresar al modo de demostración, hay 30 demostraciones para elegir. La pantalla mostrará el estado actual. número de canción de demostración (01 -30).
- Presione el botón <▶> para comenzar a reproducir las canciones de demostración. Para detener la reproducción presione el botón <> nuevamente.
- Gire la rueda de parámetros o presione los botones +/- para seleccionar una canción de demostración.
- Presione el botón SELECT en el modo de canción para saltar a la interfaz de configuración de parámetros de la canción. Puede activar el sonido de la batería. o desactivarlo girando la rueda de parámetros (el sonido de batería está activado de forma predeterminada).
- Presione el botón SELECCIONAR para confirmar y salir de la interfaz de parámetros.

### 7 PARÁMETROS DEL TAMBOR

- Presione el botón KIT y la pantalla mostrará 01 (número del kit de batería). Presione SELECT para ingresar el parámetro de batería. modo de ajuste.
- Toque el tambor que desea ajustar y luego presione los botones +/- para seleccionar el parámetro a ajustar. Sensibilidad
 

A. S(01-06). Umbral de disparo t(01 - 32).	Umbral de diafonía c (01 -32)
B. Activador repetido r(01-32) Fuerza del tambor	V(01-03). Volumen del tambor L (00 - 31).
- Cambie los parámetros girando la rueda de parámetros y mantenga presionado el botón - para guardar. La pantalla con display. SAV para indicar que el ajuste del parámetro se ha guardado correctamente.
- Para restaurar los parámetros del tambor a la configuración de fábrica, mantenga presionado el botón + hasta que la pantalla muestre RES.
- TENGA EN CUENTA: Los parámetros para los 3 toms no se pueden configurar individualmente.

### 8 FUNCIÓN DE GRABACIÓN

- Presione el botón <REC> cuando la luz indicadora esté en los estados "KIT" y "CLICK" y la pantalla muestre el palabras "REC" en el estado de respiración intermitente, ingresando al estado de preparación de grabación.
- Toca cualquier tambor y suena el metrónomo. En este momento, la pantalla muestra "---" en el estado de respiración parpadeante. y comienza a grabar.
- Presione la tecla < REC > o < PLAY > nuevamente, la grabación se detiene y se muestra "A-1" en la pantalla.
- Presione < ▶ > para comenzar a reproducir la grabación actual y presione nuevamente para detener la reproducción.
- Si ingresa nuevamente al estado de preparación de grabación sin tocar, se reproducirá el "A-1" grabado la última vez.

### 9 GUARDAR / RESTABLECER

- Para guardar los parámetros, mantenga presionado el botón <-> y la pantalla mostrará SAV.
- Para restablecer los parámetros, mantenga presionado el botón <+> y la pantalla mostrará RES res.

### 10 USB-MIDI

Para utilizar la función MID de los kits de batería, conecte un cable de datos USB-B (no incluido con este kit de batería) a la unidad de control y conéctelo a una PC/teléfono inteligente.



## APÉNDICE

## Timbre

Patada .	70 . Borde de caja de roca	134 . Roca Tom2	198 . Choque de roca1	262 . Paseo en roca	326 . Abierto de charles de rock
1 . Patada pop	71 . Borde de caja de metal	135 . tom2 metálico	199 . Choque de metal1	263 . Paseo metálico	327 . Charles metálico abierto
2 . Joder patada	72 . Borde de caja PowerMetal	136 . PowerMetal Tom2	200 . Choque de PowerMetal1	264 . Paseo PowerMetal	328 . PowerMetal charles abierto 329.
3 . Patada dura	73 . Borde de caja SpeedMetal	137 . SpeedMetal Tom2 138 .	201 . Choque de SpeedMetal1	265 . Paseo SpeedMetal	SpeedMetal Hi-Hat abierto 330. PopJazz
4 . Patada original 5.	74 . Borde de caja PopJazz	PopJazz Tom2	202 . PopJazz Crash1 203.	266 . Paseo pop-jazz	Hi-Hat abierto 331. Abierto de
Patada PopRock 6 .	75 . Borde de caja de jazz	139 . jazz tom2	Choque de jazz1	267 . Paseo de jazz	charles de jazz
Patada de roca	76 . 808	140 . 808	204 . 808	268 . 808	332 . 808
7 . Patada metálica	77 . 909	141 . 909	205 . 909	269 . 909	333 . 909
8 . Patada de powermetal	78 . Borde de caja Songo	142 . songo tom2	206 . Accidente de Songo1	270 . songo se rie	334 . Songo Hi-Hat Abierto 335.
9 . Patada SpeedMetal 10.	79 . Borde de caja estándar	143 . Tom2 estándar	207 . Accidente estándar1	271 . Paseo estándar	Charles estándar abierto 336 .
Patada PopJazz 11.	80 . Borde de caja acústica	144 . Tom2 acústico	208 . Choque acústico1	272 . Paseo acústico	Charles acústico abierto 337.
Patada de jazz	81 . Borde de caja Seesion	145 . Sesión Tom2	209 . Accidente de sesión1	273 . Paseo de la sesión	Seesion Charles Abierto 338.
12 . 808	82 . Borde de caja moderno	146 . Tom2 moderno	210 . Accidente moderno1	274 . Paseo moderno	Charles moderno abierto 339.
13 . 909	83 . Borde de caja de blues	147 . blues tom2	211 . Choque de blues1	275 . Paseo de blues	Charles de blues abierto 340.
14 . Patada Songo	84 . Borde de caja clásico	148 . Tom2 clásico	212 . Choque clásico1	276 . Paseo clásico	Charles clásico abierto 341.
15 . Patada estándar	85 . Borde de caja Synthgaze	149 . Synthgaze Tom2	213 . Synthgaze Crash1 214.	277 . Paseo Synthgaze	Synthgaze Hi-Hat abierto 342. Freak
dieciséis . Patada acústica	86 . Borde de caja extraño	150 . Tom2 extraño	Accidente extraño1	278 . paseo extraño	Hi-Hat abierto 343. Baquetas
17 . Patada de sesión	87 . Baquetas con borde de caja	151 . Palos Tom2	215 . Choque de palos1	279 . Paseo de palos	Hi-Hat abiertas 344 . Hi-Hat
18 . patada moderna	88 . Borde de caja grunge	152 . Tom2 grunge	216 . Accidente grunge1	280 . paseo grunge	grunge abierto 345. Abierto de
19 . Patada de blues	89 . Borde de caja de los 70	153 . Tom2 de los 70	217 . Accidente de los 701	281 . Paseo de los 70	charles de los 70 346. Abierto
20 . Patada clásica	90 . Borde de caja de los 80	154 . Tom2 de los 80	218 . Accidente de los 801	282 . Paseo de los 80	de charles de los 80 347.
21 . Patada Synthgaze 22.	91 . Borde de caja popular	155 . Tom2 popular	219 . Accidente popular1	283 . Paseo popular	Abierto de charles popular 348.
Patada extraña	92 . Borde de caja Slam	156 . golpe tom2	220 . Golpe de choque1	284 . Paseo de golpe	Abierto de charles Slam 349.
23 . Patada de palos	93 . Borde de trampa de ataque	157 . Ataque Tom2	221 . Ataque Crash1	285 . Paseo de ataque	Ataque de charles abierto 350.
24 . Patada grunge 25.	94 . Borde de trampa antiguo	158 . viejo tom2	222 . Viejo accidente1	286 . Paseo Viejo	Antiguo charles abierto 351.
Patada de los 70	95 . Borde de caja Fairfax	159 . FairfaxTom2	223 . Accidente de Fairfax1	287 . Paseo en Fairfax	Abierto de charles Fairfax 352.
26 . Patada de los 80	96 . Borde de trampa militar	160 . Tom militar2 161 .	224 . Accidente militar1	288 . Paseo militar	Abierto de charles militar 353.
27 . Patada Popular 28.	Tomás .	pop tom3	225 . Llanta Pop Crash1 226.	289 . Llanta Pop Ride	Pop Hi-Hat Cerrar
Patada de golpe	97 . pop tom1	162 . Joder tom3	Joder Crash1 Llanta	290 . Joder paseo borde	354 . Joder charles cerrar
29 . Patada de ataque	98 . Joder tom1	163 . Tom3 duro	227 . Llanta Hard Crash1	291 . Llanta dura	355 . Cerrar charles duro
30 . vieja patada	99 . Tom1 duro	164 . Originales Tom3	228 . Llanta Crash1 original 229.	292 . Llanta de paseo original	356 . Cierre de charles original
31 . Patada de Fairfax	100 . Tom1 original	165 . poprock tom3	Llanta PopRock Crash1 230. Llanta	293 . Rima de paseo poprock	357 . Charles PopRock Cerrar
32 . Patada militar	101 . poprock tom1	166 . Roca Tom3	Rock Crash1	294 . Llanta de paseo en roca	358 . Charles de rock Cerrar
Trampa.	102 . Roca Tom1	167 . Tom3 metálico	231 . Llanta metálica Crash1	295 . Llanta de metal	359 . Cierre de charles metálico
33 . Caja pop 34.	103 . Tom1 de metal	168 . Power Metal Tom3	232 . Llanta PowerMetal Crash1	296 . Llanta PowerMetal Ride	360 . Hi-Hat PowerMetal Cerrar
Joder trampa	104 . PowerMetal Tom1	169 . SpeedMetal Tom3 170.	233 . Llanta SpeedMetal Crash1 234.	297 . Llanta SpeedMetal Ride	361 . Cerrar charles SpeedMetal 362 .
35 . trampa dura	105 . SpeedMetal Tom1	PopJazz Tom3	Llanta PopJazz Crash1 235. Llanta	298 . Llanta de paseo PopJazz	PopJazz Hi-Hat Cerrar
36 . Caja original 37 .	106 . PopJazz Tom1	171 . jazz tom3	Jazz Crash1	299 . Llanta Jazz Ride	363 . Charles de Jazz Cerrar
Caja pop rock 38 . trampa	107 . jazz tom1	172 . 808	236 . 808	300 . 808	364 . 808
de roca	108 . 808	173 . 909	237 . 909	301 . 909	365 . 909
39 . trampa de metal	109 . 909	174 . songo tom3	238 . Llanta Songo Crash1 239.	302 . Llanta Songo Ride	366 . Hi-Hat Songo Cerrar
40 . Caja PowerMetal	110 . songo tom1	175 . Tom3 estándar	Llanta Crash1 estándar	303 . Llanta de paseo estándar	367 . Cierre de charles estándar
41 . Caja SpeedMetal 42 . Caja	111 . Tom1 estándar	176 . Tom3 acústico	240 . Llanta acústica Crash1	304 . Llanta de paseo acústico	368 . Hi-Hat acústico Cerrar
PopJazz 43 . Caja de jazz	112 . Tom acústico1	177 . Sesión Tom3	241 . Llanta Seesion Crash1	305 . Llanta Seesion Ride	369 . Seesion Hi-Hat Cerrar
44 . 808	113 . Sesión Tom1	178 . Tom3 moderno	242 . Llanta Crash1 moderna	306 . Llanta de paseo moderna	370 . Hi-Hat moderno Cerrar
45 . 909	114 . Tom1 moderno	179 . blues tom3	243 . Borde Blues Crash1	307 . Llanta de paseo de blues	371 . Charles de blues Cerrar
46 . Trampa Songo 47.	115 . blues tom1	180 . Tom3 clásico	244 . Llanta Crash1 clásica	308 . Llanta de paseo clásica	372 . Hi-Hat clásico Cerrar
Caja estándar	116 . Tom1 clásico	181 . Synthgaze Tom3	245 . Llanta Synthgaze Crash1 246.	309 . Llanta de paseo Synthgaze	373 . Cerrar charles Synthgaze
48 . Caja acústica	117 . Sintetizada Tom1	182 . monstruo tom3	Llanta Freak Crash1	310 . Llanta Freak Ride	374 . Freak Hi-Hat Cerrar
49 . Trampa de sesion	118 . monstruo tom1	183 . Palos Tom3	247 . Llanta Sticks Crash1	311 . Llanta de paseo con palos	375 . Baquetas Hi-Hat Cerrar
50 . trampa moderna	119 . Palos Tom1	184 . grunge tom3	248 . Llanta Grunge Crash1 249.	312 . Borde de paseo grunge	376 . Cierre de charles grunge
51 . Caja de blues	120 . grunge tom1	185 . Tom3 de los 70	Llanta Crash1 de los 70	313 . Llanta de paseo de los 70	377 . Hi-Hat de los 70 Cerrar
52 . Caja clásica	121 . Tom1 de los 70	186 . Tom3 de los 80	250 . Llanta Crash1 de los 80	314 . Llanta de paseo de los 80	378 . Hi-Hat de los 80 Cerrar
53 . Trampa Synthgaze 54 .	122 . Tom1 de los 80	187 . Tom3 popular	251 . Popular llanta Crash1 252.	315 . Llanta de paseo popular	379 . Cierre de charles popular
trampa anormal	123 . Popular Tom1	188 . golpe tom3	Llanta Slam Crash1	316 . Llanta Slam Ride	380 . Cierre de charles Slam
55 . Trampa de palos	124 . golpe tom1	189 . Ataque Tom3	253 . Ataque Crash1 Llanta	317 . Llanta de ataque	381 . Ataque Hi-Hat Cerrar
56 . Trampa grunge 57.	125 . Ataque Tom1	190 . viejo tom3	254 . Llanta vieja Crash1	318 . Llanta vieja	382 . Antiguo charles Cerrar
trampa de los 70	126 . viejo tom1	191 . FairfaxTom3	255 . Llanta Fairfax Crash1	319 . Llanta de paseo Fairfax	383 . Charles Fairfax Cerrar
58 . trampa de los 80	127 . FairfaxTom1	192 . Tom militar3	256 . Llanta militar Crash1	320 . Llanta de paseo militar	384 . Cierre de charles militar
59 . Caja Popular 60.	128 . Tom militar1 129 .	Chocar .	Conducir .	Hola sombrero.	385 . Pedal de charles pop
trampa de golpe	pop tom2	193 . Choque pop1	257 . Paseo pop	321 . Pop charles abierto	386 . Joder pedal de charles
61 . Trampa de ataque	130 . Joder tom2	194 . Joder Crash1	258 . Joder paseo	322 . Joder charles abierto	387 . Pedal de charles duro
62 . vieja trampa	131 . Tom2 duro	195 . Choque duro1	259 . Paseo duro	323 . Charles duro abierto	388 . Pedal de charles original 389.
63 . Trampa Fairfax	132 . Originales Tom2	196 . Accidente original1	260 . Paseo original 261.	324 . Charles original abierto	Pedal de charles PopRock
64 . Trampa militar 65 .	133 . poprock tom2	197 . Choque de poprock1	Paseo pop-rock	325 . PopRock charles abierto	390 . Pedal de charles de rock
Borde de caja pop					391 . Pedal de charles metálico
66 . A la mierda el borde de la trampa					392 . Pedal de charles PowerMetal
67 . Borde de caja duro					393 . Pedal de charles SpeedMetal
68 . Borde de caja original 69.					394 . Pedal de charles PopJazz
Rima de caja poprock					395 . Pedal de charles de jazz
					396 . 808
					397 . 909
					398 . Pedal de charles Songo
					399 . Pedal de charles estándar



## APPENDIX

400 . Pedal de charles acústico		433. Accidente de sesión2	450 . Joder Crash2 Llanta	467 . Bordé Blues Crash2
401. Pedal de charles Seesion	417 . Choque pop2	434 . Choque moderno2	451 . Llanta Hard Crash2	468. Llanta Crash2 clásica
402 . Pedal de charles moderno	418. Joder Crash2	435. Choque de blues2	452 . Llanta original Crash2	469. Llanta Synthgaze Crash2
403. Pedal de charles de blues	419 . Choque duro2	436. Choque clásico 2	453 . PopRock Crash2 Rima	470. Llanta Freak Crash2
404. Pedal de charles clásico	420. Choque original2	437 . Crash2 de mirada sintetizada	454 . Llanta Rock Crash2	471 . Llanta Sticks Crash2
405. Pedal de charles Synthgaze	421. Choque poprock2	438. Choque extraño2	455 . Llanta metálica Crash2	472 . Llanta Grunge Crash2
406 . Pedal de charles extraño	422. Choque de roca2	439 . Choque de palos2	456 . Llanta PowerMetal Crash2	473 . Llanta Crash2 de los 70
407 . Baquetas Pedal de	423. Choque de metal2	440. Choque grunge2	457 . Llanta SpeedMetal Crash2	474 . Llanta Crash2 de los 80
charles 408 . Pedal de charles	424 . Choque de PowerMetal2	441. Accidente de los 702	458 . Llanta PopJazz Crash2	475 . Llanta Crash2 popular
grunge 409. Pedal de charles	425. SpeedMetal Crash2	442 . Choque de los 802	459 . Llanta Jazz Crash2	476 . Llanta Slam Crash2
410 de los 70. Pedal de	426. PopJazz Crash2	443. Choque popular2	460. 808	477. Llanta Attack Crash2
charles de los 80 411. Popular	427 . Choque de jazz2	444 . Golpe de choque2	461. 909	478 . Llanta antigua Crash2
pedal de charles 412. Pedal	428. 808	445 . Ataque Crash2	462. Llanta Songo Crash2	479. Llanta Fairfax Crash2
de charles Slam 413. Pedal de	429 . 909	446 . Viejo accidente2	463. Llanta Crash2 estándar	480. Llanta militar Crash2
ataque de charles 414.	430. Choque de Songo2	447 . Accidente de Fairfax2	464 . Llanta acústica Crash2	
Pedal de charles antiguo 415.	431. Choque estándar2	448. Accidente militar2	465. Llanta Seesion Crash2	
Pedal de charles Fairfax 416. Pedal de charles militar	432. Choque acústico2	449 . Llanta Pop Crash2	466. Llanta Crash2 moderna	
Choque 2				

### Drum combination timbre

01 pop	09 velocidad metal
02 Joder	10 popjazz
03 Duro	11 jazz
04 originales	12 808
05 pop-rock	13 909
06 roca	14 canción
07 metales	15 estándar
08 Metal de poder	16 acústico

### User drum group

17 Sesión	25 años 70
18 moderno	26 años 80
19 azules	27 populares
20 clásico	28 golpe
21 Mirada sintética	29 Ataque
22 monstruo	30 años
23 palos	31 Fairfax
24 grunge	32 militares

### Demonstration music

Canción 001	Canción 007	Canción 013	Canción 019	Canción 025
Canción 002	Canción 008	Canción 014	Canción 020	Canción 026
Canción 003	Canción 009	Canción 015	Canción 021	Canción 027
Canción 004	Canción 010	Canción 016	Canción 022	Canción 028
Canción 005	Canción 011	Canción 017	Canción 023	Canción 029
Canción 006	Canción 012	Canción 018	Canción 024	Canción 030



## MANTENIMIENTO DEL PRODUCTO

El mantenimiento y la protección cuidadosos de este producto juegan un papel muy importante para prolongar la vida útil del producto y reducir las fallas.

#### 1 Evite el calor, la humedad o la luz solar directa.

No exponga demasiado el producto a la luz solar directa ni lo coloque cerca del aire acondicionado o en un lugar extremadamente caluroso.

#### 2 No lo use cerca de TV o radio

Este producto puede causar interferencias de video o audio en la recepción de televisión y radio. Si esto sucede, retire el producto del televisor o la radio.



## MANTENIMIENTO DEL PRODUCTO

### 3 No utilice pintura, disolventes ni productos químicos similares para la limpieza.

Utilice un paño de limpieza suave y sin suciedad humedecido en una pequeña cantidad de agua o detergente especial para limpiar las manchas de la superficie de este producto.

### 4 No sacudir para evitar colisiones.

El producto debe manipularse con cuidado al trasladarlo. Están estrictamente prohibidas las vibraciones y colisiones violentas para evitar daños a la carcasa o a los componentes electrónicos internos.



## SAFETY PRECAUTIONS

### POWER SUPPLY

This product can be powered by standard indoor wall sockets. Please only use the power cord specified in this product. When not in use, please turn off the power supply. When not in use for a long time, pull out the power cord and keep it properly.

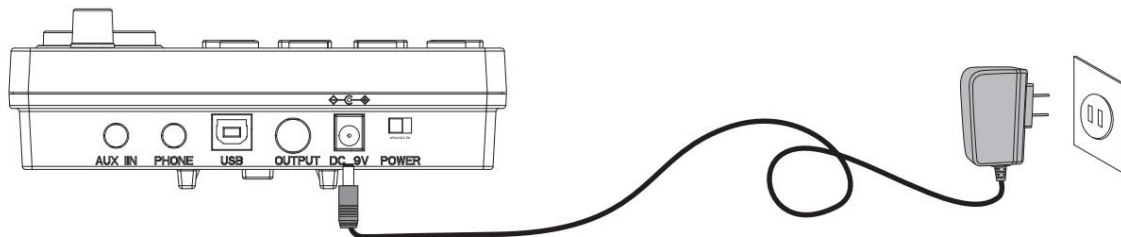

### SIGN

To ensure that you use this product safely and correctly, to prevent harm to users and others and financial damage, this manual and products are marked with a series of safety signs. The various signs and their meanings are as follows:

#### **WARNING**

This sign indicates that there is a potential risk of death or serious injury if this mark is ignored and the product is mishandled.

#### **BE CAREFUL**

This sign indicates that there is a potential danger of injury to personnel or other financial damage if this sign is ignored and the product is operated incorrectly.

### EXAMPLE OF LOGO



This triangle sign ( $\Delta$ ) indicates what users should pay attention to. (The left example is careful shocks)



A circular sign ( $\ominus$ ) with an oblique line indicates prohibitions. The icons in or beside the logo indicate the contents specifically prohibited. (The example on the left is no disassembly)



The round black bottom sign ( $\oplus$ ) indicates what must be observed. The diagrams in this sign indicate the contents of the specific matters that must be observed. (The example on the left is that the power plug must be pulled out of the socket)



## SAFETY PRECAUTIONS

### **WARNING**

#### **Smoke, odor, overheating**

When the product smokes, smells or overheats, there is a danger of fire and electric shock when it is used continually. In case of the above situation, the following operations should be performed immediately:

1. Turn off the power supply.
2. Pull the plug out of the power outlet.
3. Contact your dealer.

#### **Power cord**

1. The improper use of power cord may cause fire and electric shock. The following precautions must be observed:
  - The special power cord designated for this product must be used.
  - The AC power supply with output voltage within the rated voltage range for household use must be used.
  - Do not overload power sockets and extension lines.
2. The improper treatment of power line will lead to its damage or breakage, which will cause fire and electric shock hazards. The following precautions must be observed:
  - Do not place or heat heavy objects on power lines.
  - Do not attempt to alter or bend the power cord too much.
  - Do not twist or pull the power cord.
  - If the power cord or plug is damaged, please replace the same type of power cord.
3. Do not touch the power cord and plug with wet hands, otherwise there is a danger of electric shock.
4. Please use the power cord where the water will not splash. Water is in danger of causing fire and electric shock.
5. Never place vases or any other container containing water on this product. Water is dangerous of causing fire and electric shock.
6. Do not allow minors to unplug and touch power lines or connection boards. Minors have no common sense of electricity safety, which may cause electric shock.

### **BE CAREFUL**

The improper use of power cord may cause fire and electric shock. The following precautions must be observed:

- Never put the power cord near the oven or other heat source.
- Do not pull the cable when pulling out of the power socket. The main body of the plug must be grasped.
- The power cord plug must be inserted in the socket to the end.
- Make sure the power supply is off before connecting or disconnecting it.
- When thunderstorms occur or before traveling or other long-term departure, disconnect the power cord from the wall outlet.
- At least once a year, remove the power cord from the wall outlet and clean the dust accumulated around the plug.

#### **Do not burn this product**

Do not put this product in the fire, otherwise it will lead to product combustion and explosion of internal electronic components, which will cause fire and personnel injury.

#### **Water and foreign bodies**

Water, other liquids and (metal sheets, etc.) entering this product are in danger of causing fire and electric shock. In case of the above situation, the following operations shall be performed immediately:

1. Turn off the power supply.
2. If you are using a power cord for power supply, unplug it from the wall outlet.
3. Contact your distributor.

#### **Disassembly and transformation**

Do not disassemble or transform the product in any way, otherwise there is a risk of electric shock, scald or other personal injury. All internal inspection, adjustment and maintenance operations should be entrusted to your distributor.



## SAFETY PRECAUTIONS

### Falling or colliding

If the product falls or is damaged by strong impact, it will be in danger of causing fire and electric shock. In case of the above situation, the following operations shall be performed immediately:

1. Turn off the power supply.
2. If you are using a power cord for power supply, you need to unplug it from the wall outlet.
3. Contact your distributor.



### Plastic bag

Do not let anyone put plastic bags for this product on his head or in his mouth. Otherwise, there is a risk of asphyxia. Families with young children should pay special attention to it.



### Keep a distance from the product and the bracket

Climbing the bracket is dangerous of overturning or damage. Families with young children should pay special attention to it.



### Put

Avoid placing the product on an uneven surface or any other unstable place. Otherwise, it will cause the product to fall down, which will lead to the risk of injury.



### Product Mobility

Before moving this product, you must unplug the power cord plug from the wall outlet and pull out all other cables and connecting wires. Otherwise, it will lead to damage of power or connection wires, resulting in fire and electric shock.



### clean

Before cleaning this product, you must unplug the power cord plug from the wall outlet, otherwise there is a risk of fire and electric shock.



### Jack

The socket of this product can only be connected to the designated equipment and devices. Connecting non-designated equipment or devices is dangerous of causing fire and electric shock.



### Location selection

It should be avoided to place the product in the following places, otherwise there is a risk of fire and electric shock.



- High temperature or dusty places.
- Kitchen or other places with lampblack.
- Where the product is exposed to direct sunlight, or any other place where the product will produce high temperature.

### Volume

Don't play music long and loud. Pay special attention when using headphones. Excessive volume can damage your hearing.



### Heavy



Do not place heavy objects on this product. Otherwise, the top of the product will be overweight, causing the product to overturn or drop objects on it, which will lead to the risk of injury.



### Correct assembly of scaffolds

The incorrect assembly of the bracket may overturn, causing the product to fall off and posing a risk of injury to personnel. Therefore, it must be assembled according to the instructions in the attached installation guide to ensure that the product is properly mounted on its bracket.



	<p>Advertencia: para reducir el riesgo de lesiones, el usuario debe leer atentamente el manual de instrucciones.</p>
	<p>Este dispositivo cumple con la Parte 15 de las normas de la FCC. El funcionamiento está sujeto a las dos condiciones siguientes: (1) Este dispositivo no puede causar interferencias dañinas y (2) este dispositivo debe aceptar cualquier interferencia recibida, incluidas las interferencias que puedan causar un funcionamiento no deseado.</p>
	<p>Este producto está sujeto a las disposiciones de la Directiva Europea 2012/19/CE. El símbolo que muestra un contenedor con ruedas tachado indica que el producto requiere recogida selectiva de basura en la Unión Europea. Esto se aplica al producto y a todos los accesorios marcados con este símbolo. Los productos marcados como tales no podrán desecharse con la basura doméstica normal, sino que deberán llevarse a un punto de recogida para el reciclaje de aparatos eléctricos y electrónicos.</p>

Fabricante: Shanghaimuxinmuyeyouxiangongsi

Dirección: Shuangchenglu 803nong11hao1602A-1609shi, baoshanqu, shanghai 200000 CN.

Importado a AUS: SIHAO PTY LTD, 1 ROKEVA STREETEASTWOOD NSW 2122 Australia

Importado a EE. UU.: Sanven Technology Ltd., Suite 250, 9166 Anaheim Place, Rancho Cucamonga, CA 91730

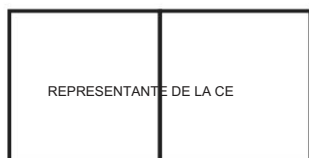

E-CrossStu GmbH  
Mainzer Landstr.69, 60329 Fráncfort del Meno.

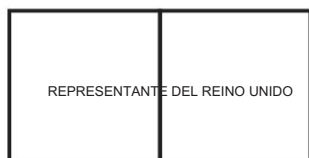

YH CONSULTING LIMITADO.  
C/O YH Consulting Limited Oficina 147, Centurion House,  
London Road, Staines upon Thames, Surrey, TW18 4AX



**VEVOR<sup>®</sup>**

**TOUGH TOOLS, HALF PRICE**

Soporte técnico y certificado de garantía  
electrónica [www.vevor.com/support](http://www.vevor.com/support)

# VEVOR<sup>®</sup>

## TOUGH TOOLS, HALF PRICE

Wsparcie techniczne i certyfikat e-gwarancji

[www.vevor.com/support](http://www.vevor.com/support)

### ELEKTRONICZNY ZESTAW PERKUSYJNY

### INSTRUKCJA OBSŁUGI

MODEL: MD200F-P

Nadal dokładamy wszelkich starań, aby zapewnić Państwu narzędzia w konkurencyjnej cenie. „Zaoszczędź o połowę”, „o połowę ceny” lub inne podobne wyrażenia używane przez nas stanowią jedynie szacunkową kwotę oszczędności, jaką możesz zyskać kupując u nas określone narzędzia w porównaniu z głównymi, najlepszymi markami i niekoniecznie oznaczają objęcie wszystkich kategorii narzędzi oferowane przez nas. Przypominamy, abyś podczas składania zamówienia u nas dokładnie sprawdził, czy faktycznie oszczędzasz połowę w porównaniu z czołowymi markami.

# VEVOR<sup>®</sup>

TOUGH TOOLS, HALF PRICE

ELEKTRONICZNY ZESTAW PERKUSYJNY

MODEL: MD200F-P

F

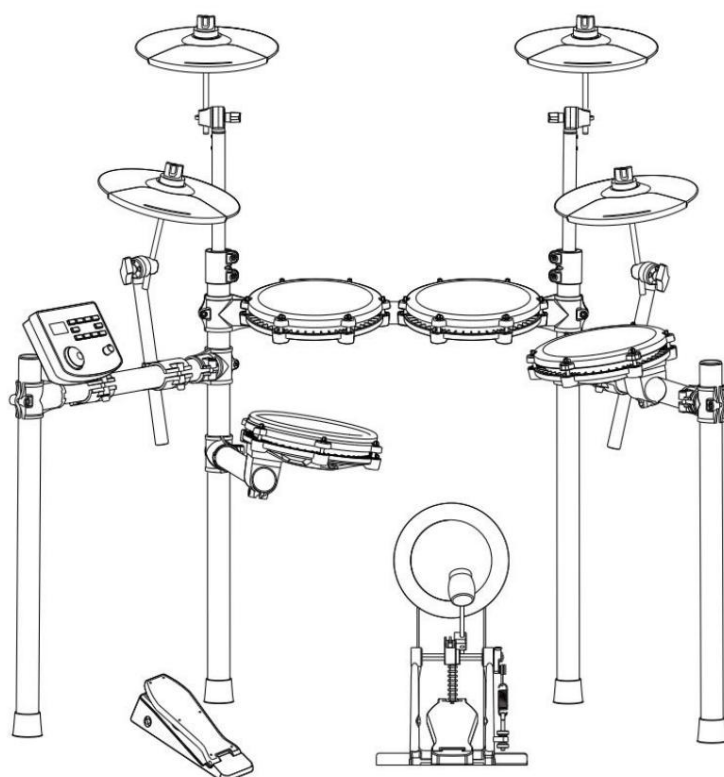

(Zdjęcie ma charakter wyłącznie poglądowy, proszę zapoznać się z rzeczywistym obiektem )

POTRZEBUJĘ POMOCY? SKONTAKTUJ SIĘ Z NAMI!

Masz pytania dotyczące produktu? Potrzebujesz wsparcia technicznego? Proszę, czuj się swobodnie by skontaktuj się

z nami: Wsparcie techniczne i certyfikat e-gwarancji [www.vevor.com/  
support](http://www.vevor.com/support)

To jest oryginalna instrukcja. Przed przystąpieniem do obsługi prosimy o dokładne zapoznanie się ze wszystkimi instrukcjami. VEVOR zastrzega sobie jasną interpretację naszej instrukcji obsługi. Wygląd produktu zależy od produktu, który otrzymałeś. Proszę wybaczyć nam, że nie będziemy ponownie informować Państwa, jeśli pojawią się jakieś aktualizacje technologii lub oprogramowania naszego produktu.



## WSTĘP FUNKCJI

Dziękujemy za wybranie naszego bębna elektronicznego. Elegancki i delikatny bęben elektroniczny to idealne połączenie nowoczesnej technologii elektronicznej. •Przed użyciem tego produktu należy szczegółowo przeczytać instrukcję.

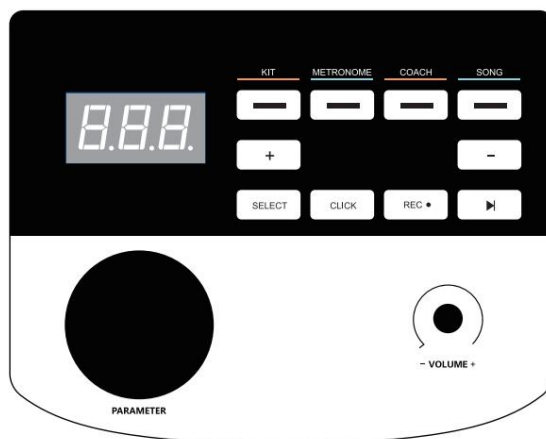

- 32 zestawy bębnow, 480 barw
- 30 piosenek
- Wsparcie regulacji parametrów czułości każdego bębna
- Trzy tryby nauczania
- Regulacja prędkości: 30 ~ 250 uderzeń/min
- Metronom: 1-9 typów
- Inne funkcje: przechowywanie parametrów, resetowanie i nagrywanie;
- trzycyfrowy wyświetlacz LED;
- interfejs: zasilacz prądu stałego, usbmidi, słuchawki, wejście audio, wyjście audio

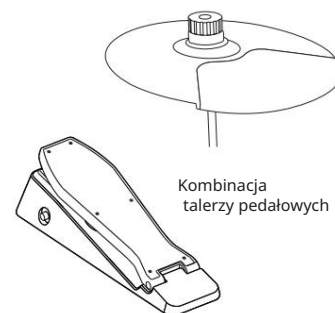
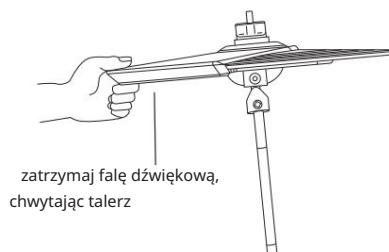
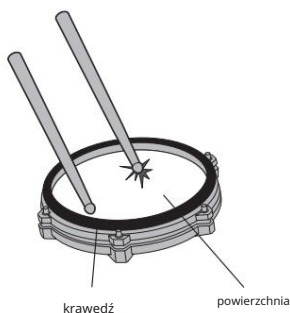

### UWAGA!

- Ten produkt jest instrumentem elektroakustycznym. To normalne, że po włączeniu zasilania w głośniku lub słuchawkach słychać niewielki prąd.  
Podczas użytkowania należy trzymać z dala od „radia, telewizora, odbiornika antenowego, routera, lodówki, telewizora, silnika i innych źródeł zakłóceń elektrycznych RF”.

**ZAWARTOŚĆ**

WSTĘP FUNKCJI .....	1
SPIS TREŚCI .....	2
INSTRUKCJA INSTALACJI .....	3
SPRAWDŹ ZAŁĄCZONE ELEMENTY .....	3
UCHWYT RURY LRON .....	4
INTUBACJA TYMPANICZNA .....	4
STOJAK MONTAŻOWY .....	5
ZAINSTALUJ MODUŁ BĘBNA .....	5
ZAMONTUJ CZĘŚCI UDERZAJĄCE I MODUŁ DŹWIĘKOWY .....	6
ZAMONTUJ BĘBEN DUŻY .....	7
ZAMONTUJ MŁOTEK .....	7
BĘBEN MOCOWANY JEST MŁOTKIEM STOPNIOWYM .....	7
PODŁĄCZ KABEL POŁĄCZENIOWY CZĘŚCI UDERZAJĄCEJ .....	7
ILUSTRACJA PORTU MODUŁU DŹWIĘKOWEGO .....	8
PODŁĄCZENIE PRZEWODU ZASILAJĄCEGO .....	8
PORT MIDI USB .....	8
PORT WYJŚCIA AUDIO .....	8
PORT WEJŚCIOWY AUDIO .....	8
PORT SŁUCHAWKOWY .....	8
ZWIĘKSZ PORT .....	8
TRYB BT .....	8
PRZEWODNIK PO OPERACJACH .....	9
MOC .....	9
WYBÓR ZESTAWU PERKUSYJNEGO .....	9
METRONOM .....	9
FUNKCJA PRAKTYCZNA .....	9
TRYB AUTOKARA .....	9
PIOSENKI DEMO .....	10
PARAMETRY BĘBNA .....	10
FUNKCJA NAGRYWANIA .....	10
ZAPISZ / RESETUJ .....	10
USB MIDI .....	11
ZAŁĄCZNIK .....	11
TMBRA .....	11
PRESET ZESTAWÓW PERKUSYJNYCH .....	11
ZESTAWY PERKUSYJNE DEFINIOWANE PRZEZ UŻYTKOWNIKA .....	11
PIOSENKA DEMOSTRACJA .....	11
KONSERWACJA PRODUKTU .....	12
ŚRODKI OSTROŻNOŚCI .....	13



## INSTRUKCJA INSTALACJI

## UWAGA!

- Postępuj zgodnie z instrukcjami i uważnie przeczytaj „Środki ostrożności” zawarte w Instrukcji obsługi przed użyciem.
- Ten produkt musi zainstalować osoba dorosła. Nie pozwól, aby osoba niepełnoletnia zainstalowała go samodzielnie.

01

## Sprawdź załączone elementy

- Po otwarciu opakowania należy natychmiast sprawdzić, czy zawiera wszystkie elementy. W przypadku jakichkolwiek pominięć należy skontaktować się ze sprzedawcą.



Moduł dźwiękowy



Wspornik modułu



Talerz \*4

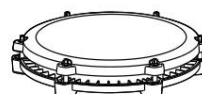

Tomek (3 szt.)



Sidla



Wspornik tylny



Wspornik łączący



Wspornik przedni



kopnięcie

2 SZT. 2 SZT. 6 SZT



śruba

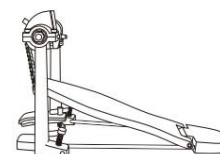

Kopnij pedał

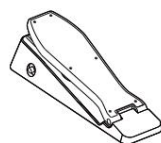
Ramię talerza  
(4szt)

Cześć, pedału



Sterownik śrubowy



Kabel połączeniowy sygnału

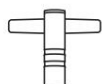

Klucz do bębna



Zasilacz



Pałka perkusyjna



Trzymaj młotek



## RYSUNEK MONTAŻOWY

### 02

#### żelazny uchwyt na rurę

•Stojak znajduje się w małym, indywidualnym opakowaniu wewnątrz pudełka.

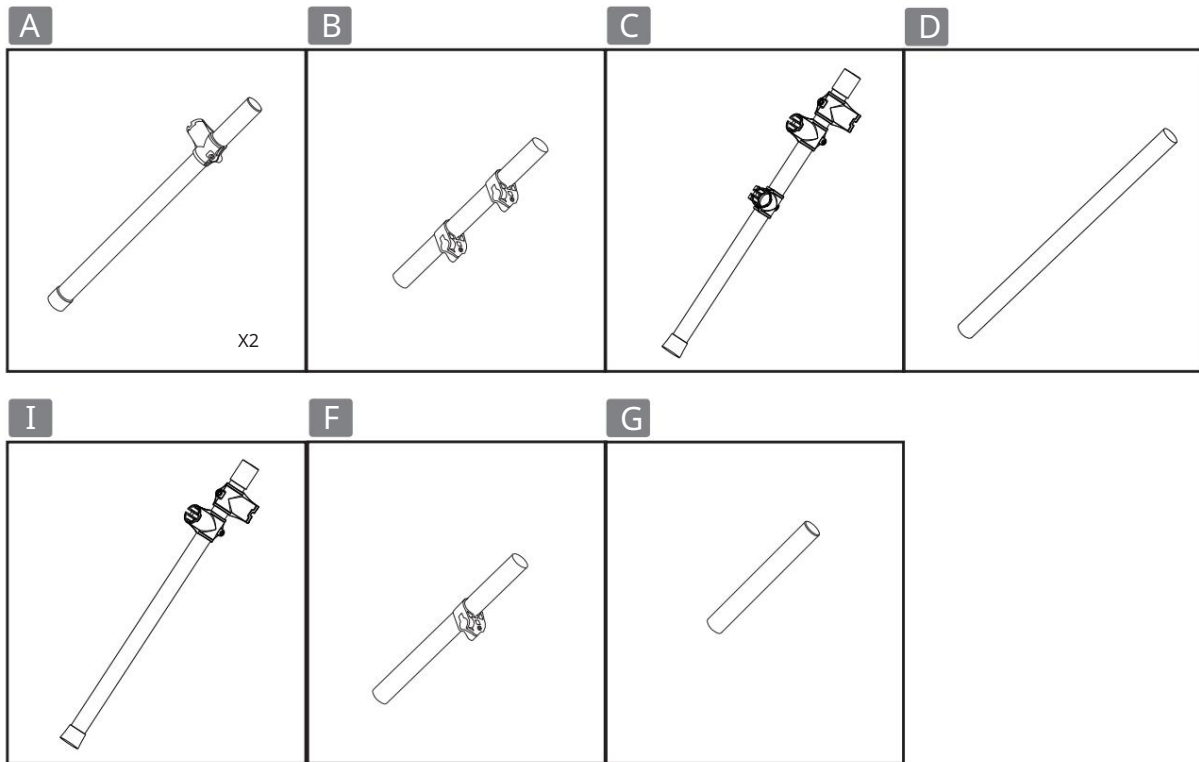

### 03 Intubacja bębnowa

Zamontuj bęben na wsporniku bębna.

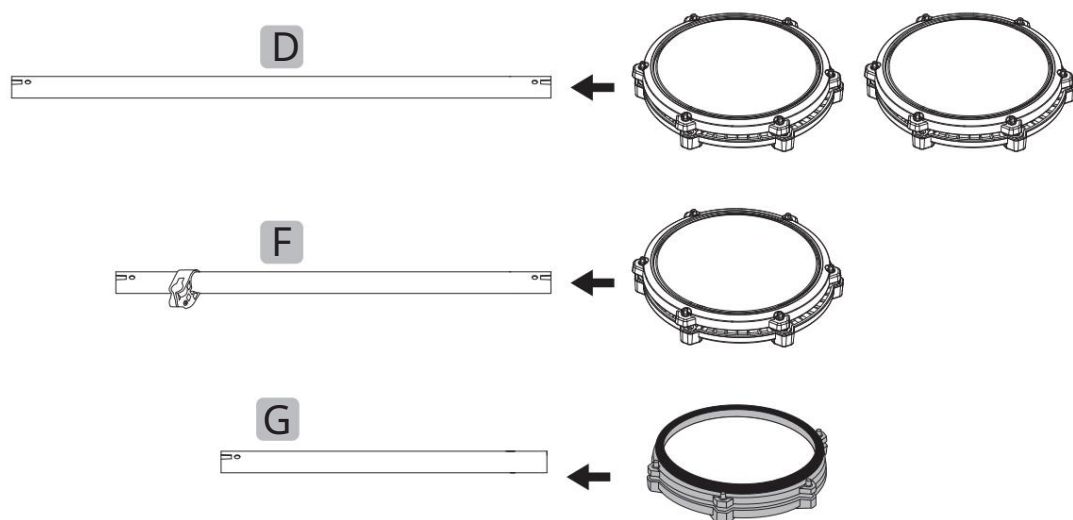



## INSTRUKCJA INSTALACJI

### 04

#### Stojak montażowy

- Podczas instalacji dokręć śruby i uważaj, aby nie przytrzasnąć palców.
- Zamontuj wspornik zgodnie z określonym kierunkiem

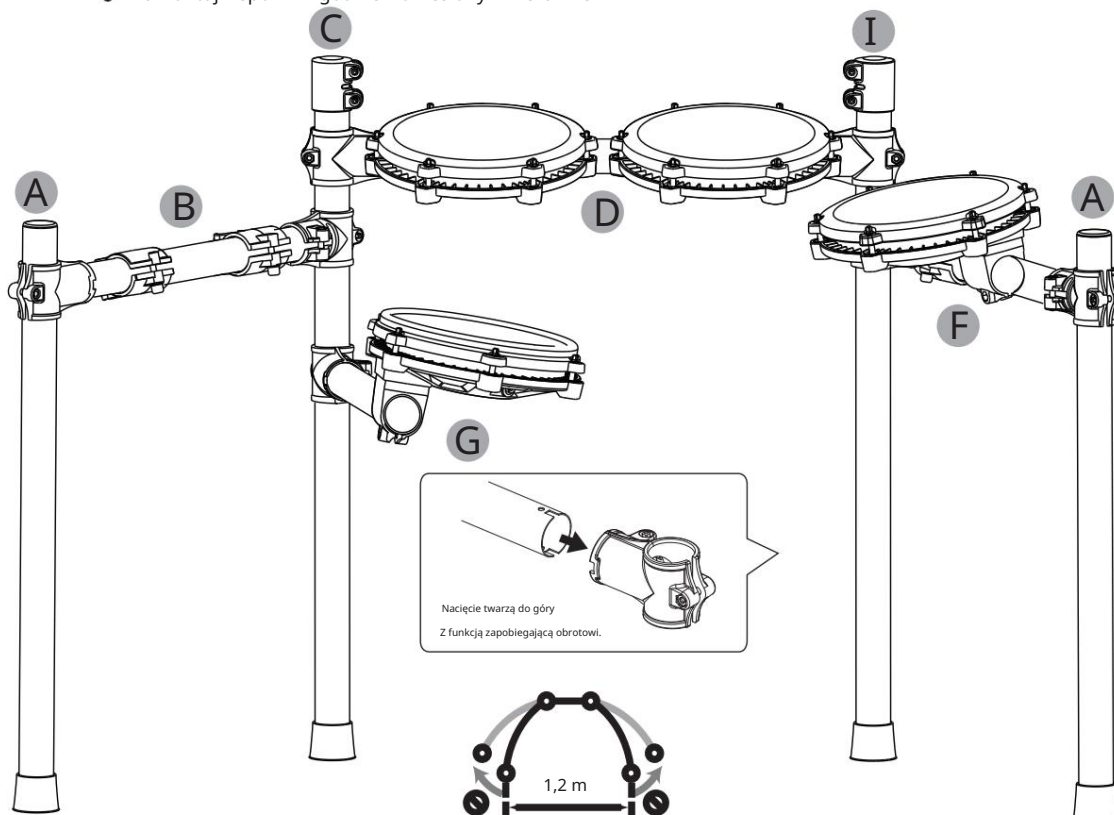

Ze względów bezpieczeństwa szerokość rozwarcia podpory nie powinna być większa niż 1,2 metra.

### 05

#### Zainstaluj moduł bębna

- Proszę włożyć go na miejsce podczas blokowania.

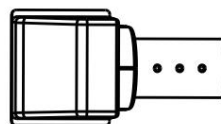
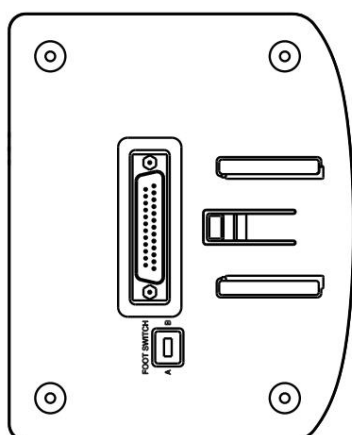

Wyrównaj moduł bębna komputera mainframe z prowadnicą skrzynki komputera mainframe i włóż go. Po włożeniu go do dołu słychać wysuwanie się zatrzasków.



## INSTRUKCJA INSTALACJI

# 06

### Zamontuj elementy uderzające i moduł dźwiękowy

- Dokręć śruby po włożeniu bębna, aby uniknąć poluzowania.
- Pamiętaj, aby nie dokręcać talerza zbyt mocno, zostaw trochę miejsca, aby talerz mógł poruszać się w górę i w dół.

Wyciągnij nakrętki i okrągłe poduszki z trzech ramion talerzy, włóż trzy talerze do odpowiedniego ramienia i przykręć nakrętki. Umieść odpowiednio 3 bębny i 1 bęben w odpowiednim pręcie nośnym i dokręć śruby.  
Uwaga: funkcje każdego talerza, bębna tomowego i werbla są różne, dlatego w celu prawidłowej instalacji należy zapoznać się z identyfikacją akcesoriów!



Rozbić się

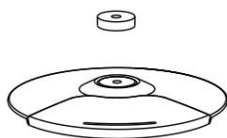

Jeździć

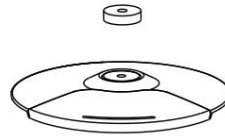

Cześć, szósta

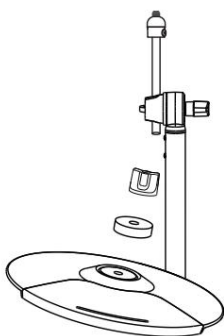

Awaria 2

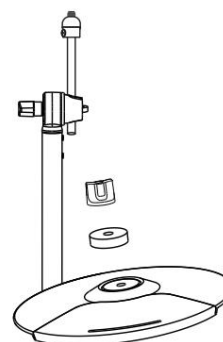

Moduł dźwiękowy



Tom1

Tom2

Tom3

Sidła

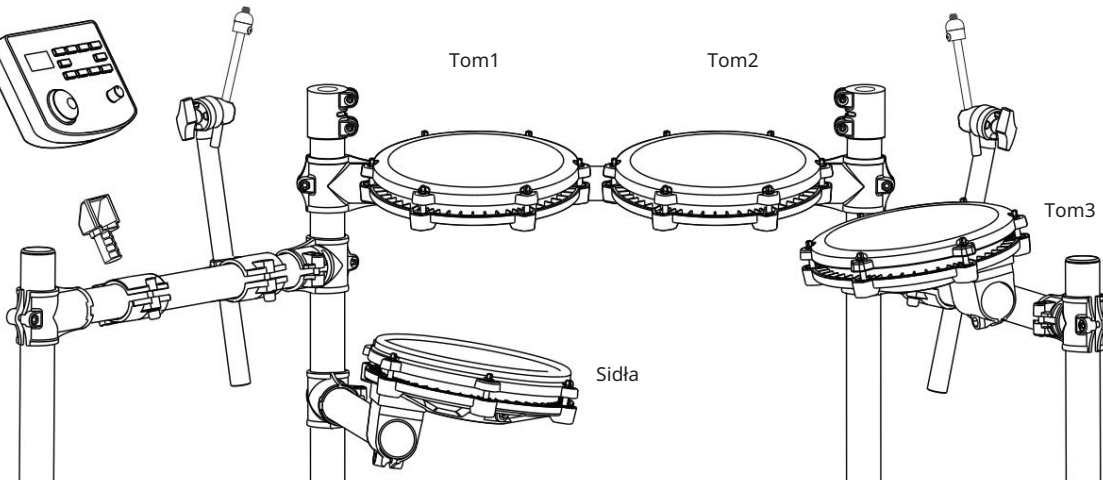



## INSTRUKCJA INSTALACJI

07

## Zainstaluj bęben basowy

- podczas montażu należy dokręcić śruby i uważać, aby nie przytrzasnąć palców.

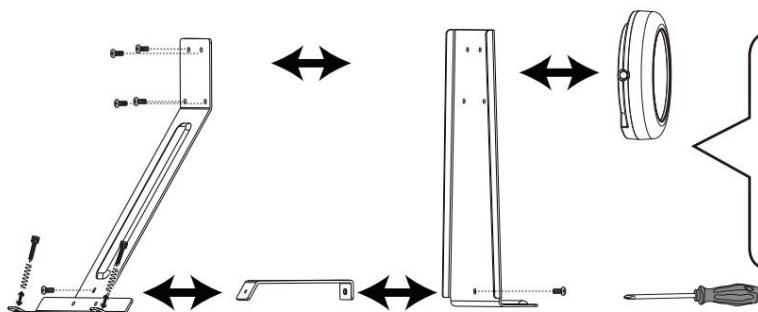

Za pomocą śrubokręta przymocuj dolny bęben, mocowania jak pokazano, podeprzyj części za pomocą 6 małych śrub. Następnie włóż 2 sprężyny do 2 śrub antypoślizgowych i zablokuj 2 sprężyny w dolnej części wspornika, aż spocznie na ziemi.

08

## Zamontuj drążek młotkowy

- drążek należy włożyć w koronkę i śruby należy dokręcić, aby uniknąć poluzowania.

Włóż pręt młotka do okrągłego otworu jak pokazano na rysunku, obróć młotek do wewnątrz, aby wyrównać go z powierzchnią bębna, a następnie dokręć kluczem bębnowym.

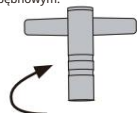

Włóż stały żelazny pręt do otworu jak pokazano na rysunku.

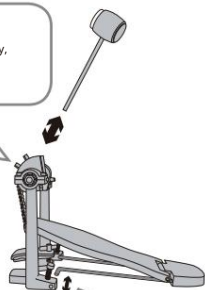

09

## Bęben basowy jest przymocowany za pomocą młotek schodkowy

- dolny bęben i młotek powinny być zamocowane i dokręcone, aby uniknąć upadku.

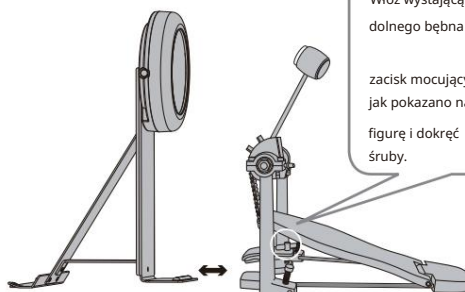

Włóż wystającą krawędź dolnego bębna do

zacisk mocujący młotek, jak pokazano na figurę i dokręć śruby.

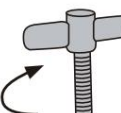

10

## Podłącz kabel połączeniowy części uderzającej

- Włóż kabel połączeniowy na miejsce, aby uniknąć słabego styku i włóż go prawidłowo, jak pokazano na schemacie.

Sprawdź, czy dolny bęben wydaje dźwięk. Jeśli nie ma dźwięku, przekręć przełącznik:  
Przełącznik w A: tryb mechanicznego bębna basowego  
Przełącznik w B: tryb pedałowania.

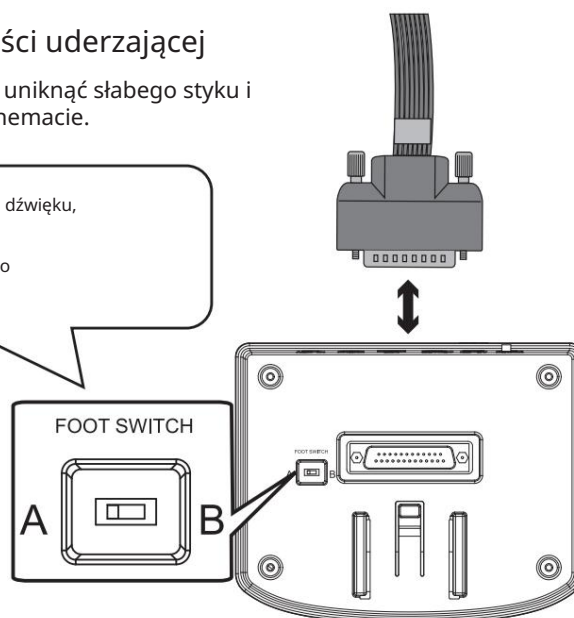



## ILUSTRACJA PORTU MODUŁU DŹWIĘKOWEGO

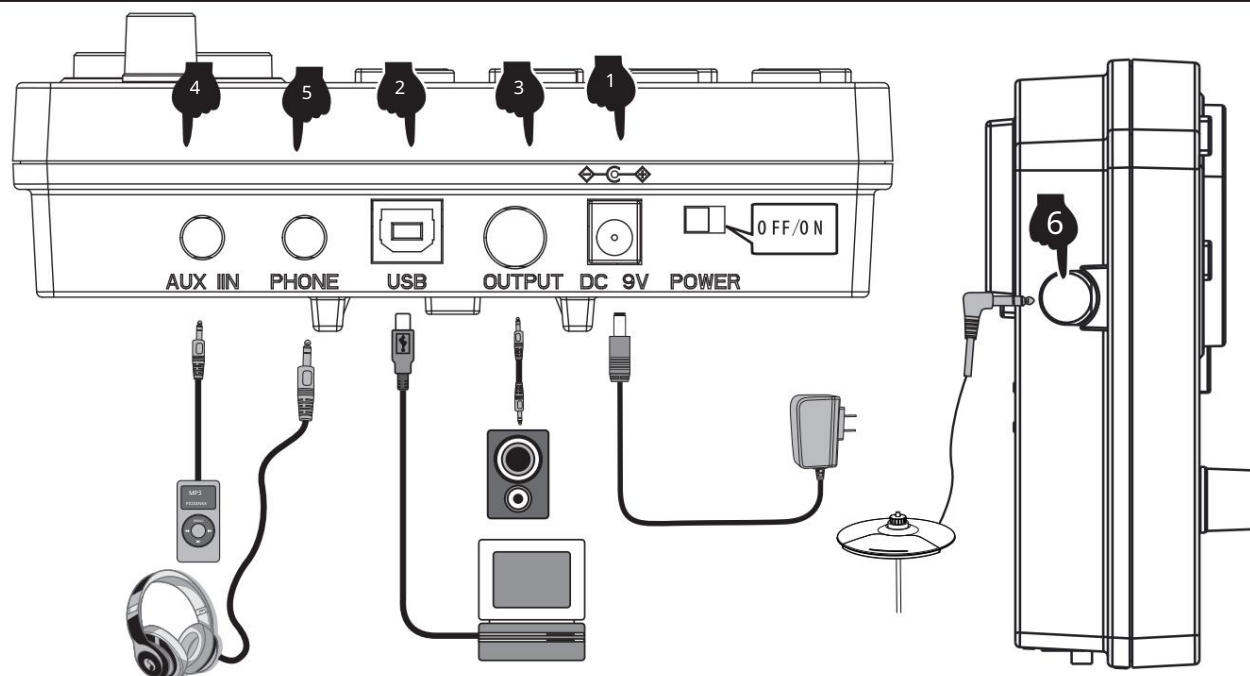

### 1 POŁĄCZENIE KABLA ZASILAJĄCEGO

1. W trakcie użytkowania podłącz zacisk zasilania zgodnie ze schematem, włóż gniazdo zasilania modułu dźwiękowego na jednym końcu i domowe gniazdko elektryczne 100–240 V na drugim końcu. (ryc. 1)
2. Jeśli nie używasz tego produktu przez dłuższy czas, wyjmij wtyczkę z gniazdka i trzymaj ją prawidłowo.

### 2 PORT MIDI USB

Dzięki zastosowaniu perkusji elektronicznej interfejs MIDI USB umożliwia interakcję z urządzeniami muzycznymi wyposażonymi w interfejs MIDI.

1. Dzięki preinstalowanemu na komputerach i telefonach komórkowym oprogramowaniu Muzyka możemy nauczyć się grać, komponować muzyka, sklep i inne funkcje. (ryc. 2)
2. W przypadku podłączenia do komputera lub telefonu komórkowego wyjście audio urządzenia należy podłączyć do gniazda wejściowego audio modułu box, aby zsynchronizować efekty dźwiękowe w urządzeniu. (ryc. 5)

### 3 PORT WYJŚCIA AUDIO

Port wyjściowy audio można podłączyć do aktywnego głośnika (specjalnego elektronicznego głośnika perkusyjnego) i dużego sprzętu audio. (ryc. 3)

### 4 PORT WEJŚCIA AUDIO

Port wejściowy audio umożliwia podłączenie urządzenia odtwarzającego źródło dźwięku do modułu w celu odtwarzania (np. telefonu komórkowego MP3 i inne wejście sygnału audio). (ryc. 4)

### 5 PORT SŁUCHAWKOWY

Podłączenie słuchawek monitoruje szczegóły perkusji i nie przeszkadza innym podczas grania bez podłączenia głośniki. (ryc. 5)

### 6 ZWIĘKSZ PORT

Ten port umożliwia dodanie talerza w celu łatwej rozbudowy. (Rysunek 6)



## PRZEWODNIK PO OPERACJACH

### 1 MOC

Włóż wtyczkę DC do portu DC 9 V na górze jednostki sterującej. Przesuń przełącznik POWER w prawo (patrząc od z przodu), aby zasilic zestaw perkusyjny. Aby wyłączyć zestaw perkusyjny, przesuń przełącznik w lewo.

### WYBÓR 2 ZESTAWÓW PERKUSYJNYCH

Naciśnij przycisk KIT, aby wyświetlić bieżący zestaw perkusyjny. Obróć pokrętko parametrów lub użyj przycisków <- /+>, aby wybrać żądaną opcję zestaw perkusyjny. Do wyboru są 32 zestawy perkusyjne – patrz lista zestawów perkusyjnych na stronie 11.

### 3 METRONOM

- Naciśnij przycisk METRONOME, aby przejść do trybu metronomu.
- Na ekranie wyświetli się wartość prędkości (domyślna prędkość 120 BPM). Obróć pokrętko parametrów lub użyj przycisków +/-, aby zmienić prędkość metronomu. Naciśnij przycisk CLICK, aby uruchomić metronom.
- Naciśnij przycisk SELECT w trybie metronomu, a ekran przeskoczy do regulacji parametrów metronomu interfejs. Za pomocą przycisków +/- możesz wybrać parametr, który chcesz dostosować:
  - r (typ rytmu: 2,4,8,16)
  - b (numer rytmu: 01-09)
  - L(głośność metronomu: 00 (wyłączony) -31), a następnie obróć pokrętko parametrów, aby dostosować ustawienia parametrów.
- Po dostosowaniu parametrów naciśnij przycisk SELECT, aby potwierdzić i wyjść z interfejsu parametrów. Następnie użyj przycisku KLIKNIJ, aby uruchomić i zatrzymać metronom zgodnie z potrzebami.

### 4 FUNKCJA PRAKTYCZNA

Tryb trenera „coach” tego produktu może pomóc w ustaleniu szybkości, dokładności i wytrzymałości, a także pomóc w kultywowaniu funkcji ćwiczeń polegającej na lepszym wyczuciu rytmu. Rób postępy pod okiem trybu trenera „coach”!

Naciśnij przycisk „trener”, aby przejść do trybu trenera. W tym trybie dostępne są trzy tryby ćwiczeń. Wybierz praktykę tryb za pomocą koła danych lub przycisku < + > < - >.

- Tryb ćwiczeń 1: Ćwiczenie z wykrywaniem uderzeń C-1: uderzaj w bęben ze stałą prędkością, aby ćwiczyć dokładność uderzenia.
- Tryb ćwiczeń 2: Tryb cichego uderzenia C-2: metronom zabrzmi w jednej sekcji i wyciszy jedną sekcję, aby ćwiczyć dokładność uderzenia bez podpowiedzi metronomu. Jest to zaawansowana wersja trybu ćwiczeń 1.
- Tryb ćwiczeń 3: Ćwiczenie szybkości C-3, metronom automatycznie zmieni prędkość i zwiększy od najwolniejszego ekspresu do najszybszego, a następnie zmniejsz prędkość od najwolniejszego ekspresu do najwolniejszej, tak jak ćwiczyć wytrzymałość na uderzenia.

### 5 TRYB TRENERA

- Tryb treningu „trenera” tego produktu może pomóc w ustaleniu szybkości, dokładności i wytrzymałości. Naciśnij COACH przycisk, aby przejść do trybu autokaru. W tym trybie dostępne są trzy tryby ćwiczeń. Do wyboru użyj koła parametrów jaki tryb ćwiczeń.
  - Tryb ćwiczeń 1: Ćwiczenie z wykrywaniem uderzeń C-1 – uderzaj w bęben ze stałą prędkością, aby ćwiczyć dokładność uderzenia.
  - Tryb ćwiczeń 2: Tryb cichego uderzenia C-2 – metronom zabrzmi w jednej sekcji i wyciszy jedną sekcję, aby ćwiczyć kiedy nie ma rytmu.
  - Tryb ćwiczeń 3: Ćwiczenie szybkości C-3 – metronom automatycznie zmieni prędkość od najwolniejszej do najszybszego, a następnie najszybszego do najwolniejszego.
- Po wybraniu trybu coachingu naciśnij przycisk KLIKNIJ. Rozpoczną się uderzenia metronomu i będziesz mógł grać na bębnie w ramach ćwiczeń.
- Po czterech uderzeniach wstępnych na wyświetlaczu pojawi się:

(za wolno)



(Dobry)



(za szybko)





## PRZEWODNIK PO OPERACJACH

4. Po zakończeniu trybu coachingu zostanie wyświetlona punktacja od 0 do 100, oceniająca dokładność ćwiczenie.

Tryb C-1: Naciśnij przycisk SELECT, aby wejść do interfejsu ustawień parametrów. Możesz dostosować liczbę ćwiczeń sesje według potrzeb (01-32). Liczba sesji do ćwiczenia określa długość tego ćwiczenia.

Tryb C-2: Naciśnij przycisk SELECT, aby wejść do interfejsu ustawień parametrów. Możesz dostosować liczbę sesji treningowych zgodnie z wymaganiami (04-32). Liczba sesji do ćwiczenia określa długość tego ćwiczenia.

Tryb C-3: Naciśnij przycisk SELECT, aby wejść do interfejsu ustawień parametrów. Można dostosować tempo, w jakim BPM zmiany (01-09 BPM).

5. Naciśnij ponownie przycisk KLIKNIJ, aby zakończyć tryb autokaru.

### 6 utworów demonstracyjnych

1. Naciśnij przycisk SONG, aby przejść do trybu demonstracyjnego. Do wyboru jest 30 wersji demonstracyjnych. Na ekranie wyświetli się prąd numer utworu demonstracyjnego (01-30).
2. Naciśnij przycisk <▶>, aby rozpocząć odtwarzanie utworów demonstracyjnych. Aby zatrzymać odtwarzanie, naciśnij ponownie przycisk <>.
3. Obróć pokrętko parametrów lub naciśnij przyciski +/-, aby wybrać utwór demonstracyjny.
4. Naciśnij przycisk SELECT w trybie utworu, aby przejść do interfejsu ustawiania parametrów utworu. Możesz włączyć dźwięk perkusji lub wyłączyć, obracając pokrętko parametrów (dźwięk perkusji jest domyślnie włączony).
5. Naciśnij przycisk SELECT, aby potwierdzić i wyjść z interfejsu parametrów.

### 7 PARAMETRY BĘBNA

1. Naciśnij przycisk KIT, a na ekranie wyświetli się 01 (numer zestawu perkusyjnego). Naciśnij SELECT, aby wprowadzić parametr bębna tryb regulacji.
2. Dotknij bębna, który chcesz wyregulować, a następnie za pomocą przycisków +/- wybierz parametr do regulacji. Czułość
 

A. S(01-06). Próg wyzwania t(01 - 32).	Próg przesłuchu c (01 -32)
B. Powtarzane wyzwania r(01-32) Siła bębna	V(01-03). Objętość bębna L (00 - 31).
3. Zmień parametry, obracając pokrętko parametrów i naciśnij długo przycisk -, aby zapisać. Ekran z wyświetlaczem SAV, aby wskazać, że regulacja parametrów została pomyślnie zapisana.
4. Aby przywrócić parametry bębna do ustawień fabrycznych należy długo naciskać przycisk + aż na ekranie wyświetli się RES.
5. UWAGA: Parametry dla bębnow 3-tomowych nie mogą być ustawiane indywidualnie.

### 8 FUNKCJA NAGRYWANIA

1. Naciśnij przycisk <REC>, gdy kontrolka znajduje się w stanie „KIT” i „CLICK”, a na ekranie pojawi się słowa „REC” w stanie migania oddechu, wejście w stan przygotowania do nagrywania.
2. Stuknij w dowolny bęben, a metronom zabrzmi. W tym momencie na ekranie pojawi się „---” w migającym stanie oddychania i rozpoczyna nagrywanie.
3. Naciśnij ponownie klawisz <REC> lub <PLAY>, nagrywanie zostanie zatrzymane, a na ekranie wyświetli się „A-1”.
4. Naciśnij <▶>, aby rozpocząć odtwarzanie bieżącego nagrania, i naciśnij ponownie, aby zatrzymać odtwarzanie.
5. Jeżeli bez pukania wejdziemy ponownie w stan przygotowania do nagrywania, odtworzone zostanie ostatnio nagrane „A-1”.

### 9 ZAPISZ/RESETUJ

1. Aby zapisać parametry naciśnij i przytrzymaj przycisk <>, na ekranie wyświetli się SAV.
2. Aby zresetować parametry naciśnij i przytrzymaj przycisk <+>, a na ekranie wyświetli się RES res.

### 10 USB MIDI

Aby skorzystać z funkcji MID zestawu perkusyjnego, podłącz kabel danych USB-B (nie dołączony do tego zestawu perkusyjnego) do jednostki sterującej i podłącz do komputera PC/smartfona.



## Tembr

Kopnięcie .	70 . Rockowa obręcz werbla	134 . Rock Tom2	198 . Uderzenie skały 1	262 . Rockowa przejazdka	326 . Rockowy Hi-Hat Otwarty
1. Popowe kopnięcie	71 . Metalowa obręcz werbla	135 . Metalowy Tom2	199 . Upadek metalu 1	263 . Metalowa przejazdka	327 . Metalowy hi-hat otwarty
2. Kurwa kopnięcie	72 . Obręcz werbla PowerMetal	136 . PowerMetal Tom2	200 . Awaria PowerMetalu 1	264 . Powermetalowa przejazdka	328 . Hi-Hat PowerMetal otwarty 329 .
3. Mocne kopnięcie	73 . Obręcz werbla SpeedMetal	137 . SpeedMetal Tom2 138 .	201 . Awaria SpeedMetal1 202 .	265 . Przejazdka SpeedMetalem	SpeedMetal Hi-Hat otwarty 330 . Popjazz
4. Oryginalne kopnięcie	74 . Popjazzowy werbel	Popjazz Tom2	Popjazzowy wypadek1 203 .	266 . Popjazzowa przejazdka	Hi-Hat Open 331 . Jazzowy Hi-Hat
5. Poprockowe kopnięcie	75 . Obręcz werbla jazzowego	139 . Jazz Tom2	Jazzowy krach 1	267 . Jazda jazzowa	Otwarty
6. Rockowe kopnięcie	76 . 808	140 . 808	204 . 808	268 . 808	332 . 808
7. Metalowe kopnięcie	77 . 909	141 . 909	205 . 909	269 . 909	333 . 909
8. Powermetalowe kopnięcie	78 . Obręcz werbla Songo	142 . Songo Tom2	206 . Songo Crash1 207 .	270 . Songo się śmieje	334 . Songo Hi-Hat otwarty 335 .
9. SpeedMetalowe kopnięcie	79 . Standardowa obręcz werbla	143 . Standardowy Tom2	Standardowa awaria 1	271 . Standardowa jazda	Standardowy hi-hat otwarty 336 . Hi-
10. Popjazzowy Kick 11.	80 . Obręcz werbla akustycznego	144 . Akustyczny Tom2	208 . Katastrofa akustyczna 1	272 . Jazda akustyczna	Hat akustyczny otwarty 337 .
Jazzowy kop	81 . Seesion Snare Rim	145 . Zobacz Tom2	209 . Awaria Sesji 1	273 . Jazda sesyjna	Seesion Hi-Hat otwarty 338 .
12 . 808	82 . Nowoczesna obręcz werbla	146 . Nowoczesny Tom2	210 . Współczesny wypadek 1	274 . Nowoczesna jazda	Nowoczesny hi-hat otwarty 339 .
13 . 909	83 . Bluesowa obręcz werbla	147 . Blues Tom2	211 . Bluesowy krach 1	275 . Bluesowa przejazdka	Hi-Hat bluesowy otwarty 340 .
14 . Kopnięcie Songo	84 . Klasyczna obręcz werbla	148 . Klasyczny Tom2	212 . Klasyczny wypadek 1	276 . Klasyczna jazda	Klasyczny hi-hat otwarty 341 .
15. Standardowe kopnięcie	85 . Synthgaze Snare Rim	149 . Synthgaze Tom2	213 . Awaria Synthgaze1 214 .	277 . Przejazdka Synthgazem	Synthgaze Hi-Hat otwarty 342 . Freak
16 . Kopnięcie akustyczne	86 . Freak Snare Rim	150 . Dziwak Tom2	Dziwny wypadek 1	278 . Dziwna jazda	Hi-Hat otwarty 343 . Kije Hi-Hat
17 . Sesionowe kopnięcie	87 . Kije Snare Rim	151 . Trzyma Tom2	215 . Awaria kijów 1	279 . Jazda na kije	otwarte 344 . Grunge Hi-Hat
18. Nowoczesne kopnięcie	88 . Grunge Snare Rim	152 . Grunge Tom2	216 . Grunge Crash1 217 .	280 . Grungeowa przejazdka	Otwarty 345 . Otwarty Hi-Hat z lat
19 . Bluesowy kop	89 . Werbel z lat 70	153 . Tom2 z lat 70	Wypadek z lat 70 . 1	281 . Przejazdka w stylu lat 70	70 . 346 . Otwarty Hi-Hat z lat
20 . Klasyczny kop	90 . Werbel z lat 80	154 . Tom2 z lat 80	218 . Wypadek z lat 80 . 1	282 . Przejazdka lat 80	80 . 347 . Popularny Hi-Hat
21 . Synthgaze Kick 22 .	91 . Popularny werbel	155 . Popularny Tom2	219 . Popularny Crash1 220 .	283 . Popularna przejazdka	Open 348 . Slam Hi-Hat otwarty
Dziwny kop	92 . Slam Snare Rim	156 . Uderz Tom2	Gwałtowny wypadek 1	284 . Slamowa jazda	349 . Atak Hi-Hat otwarty 350 .
23 . Kopnięcie kijem	93 . Atakuj Snare Rim	157 . Atakuj Tom2	221 . Awaria ataku 1	285 . Jazda w ataku	Stary hi-hat otwarty 351 . Hi-Hat
24 . Grungeowe kopnięcie	94 . Stara obręcz werbla	158 . Stary Tom2	222 . Stary wypadek 1	286 . Stara jazda	Fairfax otwarty 352 .
25 . Kopnięcie z lat 70	95 . Obręcz werbla Fairfax	159 . Fairfax Tom2	223 . Awaria Fairfaxa 1	287 . Przejazdka Fairfaxem	Wojskowy hi-hat otwarty 353 .
26 . Kopnięcie z lat 80	96 . Obręcz werbla wojskowego	160 . Wojskowy Tom2	224 . Katastrofa wojskowa1	288 . Przejazdka wojskowa	Pop Hi-Hat blisko
27 . Popularne kopnięcie	Tomek .	161 . Pop Tom3	225 . Pop Crash1 Obręcz 226 .	289 . Pop Ride Rim	354 . Pieprzyć hi-hat blisko
28 . Slamowe kopnięcie		162 . Pieprzyć Tom3	Jebać obręcz Crash1	290 . Pieprzyć Rim Rim	355 . Zamknięcie twardego hi-hatu
29 . Kopnięcie ataku		163 . Twardy Tom3	227 . Obręcz Hard Crash1	291 . Obręcz do twardej jazdy	356 . Oryginalny hi-hat Close 357 .
30 . Stary kop		164 . Oryginalny Tom3 165.	228 . Oryginalna obręcz Crash1 229.	292 . Oryginalna obręcz Ride	Hi-Hat PopRock Zamknij
31 . Kopnięcie Fairfaxa		PopRock Tom3	PopRock Crash1 Obręcz 230 . Obręcz	293 . PopRock Ride Rym	358 . Rockowy hi-hat blisko
32 . Kopnięcie wojskowe		166 . Rock Tom3	Rock Crash1	294 . Obręcz Rock Ride	359 . Metalowy hi-hat zamknięty
Sidla.		167 . Metalowy Tom3	231 . Obręcz Metal Crash1	295 . Metalowa obręcz do jazdy	360 . Zamknięcie hi-hatu PowerMetal
33 . Popowy werbel	100 . Oryginalny Tom1	168 . PowerMetal Tom3	232 . Obręcz PowerMetal Crash1	296 . Obręcz PowerMetal	361 . Hi-Hat SpeedMetal Zamknij 362 . Hi-
34 . Jebać Snare'a	101 . PopRock Tom1	169 . SpeedMetal Tom3 170 .	233 . Obręcz SpeedMetal Crash1 234 .	297 . Obręcz SpeedMetal	Hat Popjazz Zamknij
35 . Twardy werbel	102 . Rock Tom1	Popjazz Tom3	Popjazz Crash1 Obręcz 235 . Obręcz	298 . Obręcz Popjazz Ride	366 . Zamknięcie hi-hatu Songo
36 . Oryginalny werbel	103 . Metalowy Tom1	171 . Jazz Tom3	Jazz Crash1	299 . Obręcz jazdy jazzowej	367 . Standardowy hi-hat zamknięty
37 . Pop-rockowy werbel	104 . PowerMetal Tom1	172 . 808	236 . 808	300 . 808	368 . Akustyczny hi-hat zamknięty
38 . Rockowy werbel	105 . SpeedMetal Tom1	173 . 909	237 . 909	301 . 909	369 . Seesion Hi-Hat blisko
39 . Metalowy werbel	106 . Popjazz Tom1	174 . Songo Tom3	238 . Songo Crash1 Obręcz 239 .	302 . Obręcz Songo Ride	370 . Nowoczesny hi-hat zamknięty
40 . Powermetalowy werbel	107 . Jazz Tom 1	175 . Standardowy Tom3	Standardowa obręcz Crash1	303 . Standardowa obręcz do jazdy	371 . Bluesowy hi-hat blisko
41 . SpeedMetalowe werble 42 .	108 . 808	176 . Akustyczny Tom3	240 . Obręcz Acoustic Crash1	304 . Obręcz akustyczna	372 . Klasyczny hi-hat blisko
Popjazzowy Werbel 43 .	109 . 909	177 . Zobacz Tom3	241 . Obręcz Seesion Crash1	305 . Obręcz Seesion Ride	373 . Synthgaze Hi-Hat Zamknij
Werbel jazzowy	110 . Songo Tom1	178 . Nowoczesny Tom3	242 . Nowoczesna obręcz Crash1	306 . Nowoczesna obręcz Ride	374 . Freak Hi-Hat blisko
44 . 808	111 . Standardowy Tom1	179 . Blues Tom3	243 . Obręcz Blues Crash1	307 . Obręcz Blues Ride	375 . Trzyma hi-hat blisko
45 . 909	112 . Tom akustyczny 1	180 . Klasyczny Tom3	244 . Klasyczna obręcz Crash1	308 . Klasyczna obręcz Ride	376 . Grunge Hi-Hat blisko
46 . Songo Werbel 47.	113 . Sesja Tom1	181 . Synthgaze Tom3	245 . Synthgaze Crash1 Obręcz 246 .	309 . Obręcz Synthgaze Ride	377 . Hi-Hat z lat 70-tych blisko
Standardowy werbel	114 . Nowoczesny Tom1	182 . Dziwak Tom3	Obręcz Freak Crash1	310 . Obręcz Freak Ride	378 . Hi-Hat z lat 80-tych blisko
48 . Werbel akustyczny	115 . Blues Tom 1	183 . Trzyma Tom3	247 . Kije Crash1 Obręcz	311 . Sticks Rim Rim	379 . Popularny Hi-Hat Close
49 . Seesion Snare	116 . Klasyczny Tom1	184 . Grunge Tom3	248 . Grunge Crash1 Obręcz 249 .	312 . Grunge Ride Rim	380 . Zatrzaśnij hi-hat blisko
50 . Nowoczesny werbel	117 . Synthgaze Tom1	185 . Tom 3 z lat 70	Obręcz Crash1 z lat 70	313 . Obręcz jazdy z lat 70	381 . Atak Hi-Hat blisko
51 . Bluesowa pułapka	118 . Dziwak Tom1	186 . Tom 3 z lat 80	250 . Obręcz Crash1 z lat 80	314 . Obręcz jazdy z lat 80	382 . Stary hi-hat blisko
52 . Klasyczny werbel	119 . Trzyma Tom1	187 . Popularny Tom3	251 . Popularna obręcz Crash1 252.	315 . Popularna obręcz Ride	383 . Zamknięcie hi-hatu Fairfax
53 . Sidla Synthgaze 54 .	120 . Grunge Tom1	188 . Uderz Tom3	Obręcz Slam Crash1	316 . Obręcz Slam Ride	384 . Wojskowy hi-hat Zamknij
Dziwny Snap	121 . Tom 1 z lat 70	189 . Zaatakuj Tom3	253 . Atak Crash1 Rim	317 . Rim ataku	385 . Popowy pedał hi-hat
55 . Kije Sierść	122 . Tom 1 z lat 80	190 . Stary Tom3	254 . Stara felga Crash1	318 . Stara obręcz do jazdy	386 . Pieprzyć pedał hi-hatu
56 . Grunge werbel 57 .	123 . Popularny Tom1	191 . Fairfax Tom3	255 . Obręcz Fairfax Crash1	319 . Obręcz Fairfax	387 . Twardy pedał hi-hatu
Werbel z lat 70	124 . Uderz Tom1	192 . Wojskowy Tom3	256 . Obręcz Military Crash1	320 . Obręcz wojskowa	388 . Oryginalny pedał hi-hat 389.
58 . Werbel z lat 80	125 . Zaatakuj Tomka 1				Pedał Hi-Hat PopRock
59 . Popularny werbel 60.	126 . Stary Tom1				390 . Pedał rockowego hi-hatu
Uderzenie werbla	127 . Fairfax Tom1				391 . Metalowy pedał hi-hatu
61 . Atakuj Snare'a	128 . Wojskowy Tom1				392 . Pedał PowerMetal Hi-Hat
62 . Stary Werbel	129 . Pop Tom2				393 . Pedał SpeedMetal Hi-Hat 394 . Pedał
63 . Werbel Fairfaxa	130 . Pieprzyć Tom2				pop-jazzowego hi-hatu
64 . Sidla wojskowe 65 .	131 . Twardy Tom1				395 . Pedał jazzowego hi-hatu
Popowy werbel	132 . Oryginalny Tom2				396 . 808
66 . Jebać Snare Rima	133 . PopRock Tom2				397 . 909
67 . Twarda obręcz werbla					398 . Pedał Songo Hi-Hat
68 . Oryginalna obręcz werbla					399 . Standardowy pedał hi-hatu
69 . PopRockowy rym werblowy					
		193 . Pop-awaria 1	257 . Popowa		
		194 . Pieprzyć Crasha 1	przejazdka 258 . Kurwa jazda		
		195 . Ciężka awaria 1	259 . Ciężka jazda		
		196 . Oryginalna awaria1	260 . Oryginalna przejazdka		
		197 . Poprockowy wypadek 1	261 . Poprockowa przejazdka		
		Rozbić się .	Jeździć .		
				Cześć-Hat.	
				321 . Pop Hi-Hat otwarty	
				322 . Kurwa, Hi-Hat otwarty	
				323 . Twardy hi-hat otwarty	
				324 . Oryginalny Hi-Hat otwarty	
				325 . Hi-Hat PopRock otwarty	



## APPENDIX

400 . Akustyczny pedał hi-hatu		433 . Awaria Sesji 2	450 . Jebać obręcz Crash2	467 . Obręcz Blues Crash2
401 . Pedał Hi-Hat firmy Seesion	417 . Pop Crash2	434 . Nowoczesny Crash2	451 . Obręcz Hard Crash2	468 . Klasyczna obręcz Crash2
402 . Nowoczesny pedał hi-hat	418 . Jebać Crasha 2	435 . Bluesowy krach 2	452 . Oryginalna obręcz Crash2	469 . Obręcz Synthgaze Crash2
403 . Pedał bluesowego hi-hatu	419 . Ciężka awaria 2	436 . Klasyczny Crash2	453 . PopRock Crash2 Rym	470 . Obręcz Freak Crash2
404 . Klasyczny pedał hi-hatu	420 . Oryginalny Crash2	437 . Awaria Synthgaze2	454 . Obręcz Rock Crash2	471 . Kije Crash2 do obręczy
405 . Pedał Hi-Hat Synthgaze	421 . PopRock Crash2	438 . Dziwny wypadek 2	455 . Obręcz Metal Crash2	472 . Obręcz Grunge Crash2
406 . Freak Hi-Hat pedał	422 . Uderzenie skały 2	439 . Sticks Crash2	456 . Obręcz PowerMetal Crash2	473 . Obręcz Crash2 z lat 70
407 . Kije pedału Hi-Hat 408 .	423 . Uderzenie metalu2	440 . Grunge Crash2	457 . Obręcz SpeedMetal Crash2	474 . Obręcz Crash2 z lat 80
Pedał hi-hatu grunge 409 .	424 . Awaria PowerMetal2	441 . Wypadek z lat 70.2	458 . Obręcz Popjazz Crash2	475 . Popularna obręcz Crash2
Pedał Hi-Hat z lat 80. 410.	425 . Awaria SpeedMetal2	442 . Wypadek z lat 80.2	459 . Obręcz Jazz Crash2	476 . Obręcz Slam Crash2
Pedał Hi-Hat z lat 80. 411.	426 . Popjazz Crash2	443 . Popularny Crash2	460 . 808	477 . Obręcz ataku Crash2
Popularny pedał Hi-Hat 412.	427 . Jazzowy krach 2	444 . Gwałtowny wypadek 2	461 . 909	478 . Stara felga Crash2
Pedał Hi-Hat 413 . Pedał	428 . 808	445 . Awaria ataku 2	462 . Obręcz Songo Crash2	479 . Obręcz Fairfax Crash2
ataku Hi-Hat 414 . Stary pedał	429 . 909	446 . Stary Crash2	463 . Standardowa obręcz Crash2	480 . Obręcz Military Crash2
hi-hatu 415 . Pedał Fairfax	430 . Katastrofa Songo2	447 . Awaria Fairfaxa 2	464 . Obręcz Acoustic Crash2	
Hi-Hat 416 . Wojskowy pedał	431 . Standardowa awaria 2	448 . Katastrofa wojskowa 2	465 . Obręcz Seesion Crash2	
hi-hatu	432 . Akustyczny krach 2	449 . Obręcz Pop Crash2	466 . Nowoczesne obręcz Crash2	
Awaria 2				

### Drum combination timbre

01 Pop	09 SpeedMetal
02 Kurwa	10 Popjazz
03 Trudno	11 Jazz
04 Oryginał	12 808
05 Pop-rock	13 909
06 Skała	14 Songo
07 Metal	15 Standardowe
08 Powermetal	16 Akustyka

### User drum group

17 Widzenie	25 lat 70-tych
18 Nowoczesne	26 80-te
19 Bluesa	27 Popularne
20 Klasyka	28 Uderzenie
21 Syntetyczne spojrzenie	29 Atak
22 Dziwak	30 Stary
23 patyki	31 Fairfaxu
24 Grunge	32 Wojskowe

### Demonstration music

Piosenka 001	Piosenka 007	Piosenka 013	Piosenka 019	Piosenka 025
Piosenka 002	Piosenka 008	Piosenka 014	Piosenka 020	Piosenka 026
Piosenka 003	Piosenka 009	Piosenka 015	Piosenka 021	Piosenka 027
Piosenka 004	Piosenka 010	Piosenka 016	Piosenka 022	Piosenka 028
Piosenka 005	Piosenka 011	Piosenka 017	Piosenka 023	Piosenka 029
Piosenka 006	Piosenka 012	Piosenka 018	Piosenka 024	Piosenka 030



## KONSERWACJA PRODUKTU

Staranna konserwacja i ochrona tego produktu odgrywa bardzo ważną rolę w przedłużeniu żywotności produktu i zmniejszeniu liczby usterek.

#### 1 Unikaj ciepła, wilgoci i bezpośredniego światła słonecznego

Nie wystawiaj produktu na bezpośrednie działanie promieni słonecznych, nie umieszczaj go w pobliżu klimatyzatora lub w bardzo gorącym miejscu.

#### 2 Nie używaj w pobliżu telewizora lub radia

Ten produkt może powodować zakłócenia obrazu lub dźwięku w odbiorze telewizji i radia. Jeżeli tak się stanie, należy usunąć produkt z telewizora lub radia.



## KONSERWACJA PRODUKTU

### 3 Do czyszczenia nie używaj farb, rozcieńczalników ani podobnych środków chemicznych

Do czyszczenia płam powierzchniowych produktu należy używać miękkiej i niezabrudzonej ściereczki zamoczonej w niewielkiej ilości wody lub specjalnego detergentu.

### 4 nie potrząśnij, aby uniknąć kolizji

Z produktem należy obchodzić się ostrożnie podczas przenoszenia. Gwałtowne wibracje i kolizje są surowo zabronione, aby uniknąć uszkodzenia obudowy lub wewnętrznych elementów elektronicznych.



## SAFETY PRECAUTIONS

### POWER SUPPLY

This product can be powered by standard indoor wall sockets. Please only use the power cord specified in this product. When not in use, please turn off the power supply. When not in use for a long time, pull out the power cord and keep it properly.

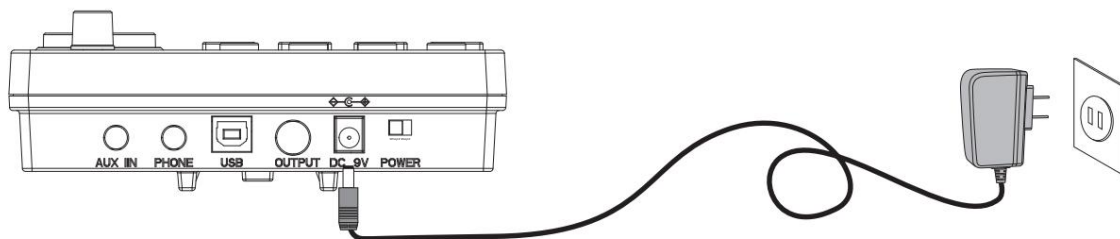

### SIGN

To ensure that you use this product safely and correctly, to prevent harm to users and others and financial damage, this manual and products are marked with a series of safety signs. The various signs and their meanings are as follows:

#### **WARNING**

This sign indicates that there is a potential risk of death or serious injury if this mark is ignored and the product is mishandled.

#### **BE CAREFUL**

This sign indicates that there is a potential danger of injury to personnel or other financial damage if this sign is ignored and the product is operated incorrectly.

### EXAMPLE OF LOGO



This triangle sign ( $\Delta$ ) indicates what users should pay attention to. (The left example is careful shocks)



A circular sign ( $\ominus$ ) with an oblique line indicates prohibitions. The icons in or beside the logo indicate the contents specifically prohibited. (The example on the left is no disassembly)



The round black bottom sign ( $\oplus$ ) indicates what must be observed. The diagrams in this sign indicate the contents of the specific matters that must be observed. (The example on the left is that the power plug must be pulled out of the socket)



## SAFETY PRECAUTIONS











### ⚠️ WARNING

#### Smoke, odor, overheating

When the product smokes, smells or overheats, there is a danger of fire and electric shock when it is used continually. In case of the above situation, the following operations should be performed immediately:



1. Turn off the power supply.
2. Pull the plug out of the power outlet.
3. Contact your dealer.

#### Power cord

1. The improper use of power cord may cause fire and electric shock. The following precautions must be observed:
  - The special power cord designated for this product must be used. 
  - The AC power supply with output voltage within the rated voltage range for household use must be used. 
  - Do not overload power sockets and extension lines. 
2. The improper treatment of power line will lead to its damage or breakage, which will cause fire and electric shock hazards. The following precautions must be observed:
  - Do not place or heat heavy objects on power lines. 
  - Do not attempt to alter or bend the power cord too much. 
  - Do not twist or pull the power cord. 
  - If the power cord or plug is damaged, please replace the same type of power cord. 
3. Do not touch the power cord and plug with wet hands, otherwise there is a danger of electric shock. 
4. Please use the power cord where the water will not splash. Water is in danger of causing fire and electric shock. 
5. Never place vases or any other container containing water on this product. Water is dangerous of causing fire and electric shock. 
6. Do not allow minors to unplug and touch power lines or connection boards. Minors have no common sense of electricity safety, which may cause electric shock. 

### ⚠️ BE CAREFUL

The improper use of power cord may cause fire and electric shock. The following precautions must be observed:

- Never put the power cord near the oven or other heat source. 
- Do not pull the cable when pulling out of the power socket. The main body of the plug must be grasped.
- The power cord plug must be inserted in the socket to the end.
- Make sure the power supply is off before connecting or disconnecting it.
- When thunderstorms occur or before traveling or other long-term departure, disconnect the power cord from the wall outlet. 
- At least once a year, remove the power cord from the wall outlet and clean the dust accumulated around the plug.

#### Do not burn this product

Do not put this product in the fire, otherwise it will lead to product combustion and explosion of internal electronic components, which will cause fire and personnel injury. 

#### Water and foreign bodies

Water, other liquids and (metal sheets, etc.) entering this product are in danger of causing fire and electric shock. In case of the above situation, the following operations shall be performed immediately: 

1. Turn off the power supply.
2. If you are using a power cord for power supply, unplug it from the wall outlet.
3. Contact your distributor.

#### Disassembly and transformation

Do not disassemble or transform the product in any way, otherwise there is a risk of electric shock, scald or other personal injury. All internal inspection, adjustment and maintenance operations should be entrusted to your distributor. 



## SAFETY PRECAUTIONS

### Falling or colliding

If the product falls or is damaged by strong impact, it will be in danger of causing fire and electric shock. In case of the above situation, the following operations shall be performed immediately:

1. Turn off the power supply.
2. If you are using a power cord for power supply, you need to unplug it from the wall outlet.
3. Contact your distributor.



### Plastic bag

Do not let anyone put plastic bags for this product on his head or in his mouth. Otherwise, there is a risk of asphyxia. Families with young children should pay special attention to it.



### Keep a distance from the product and the bracket

Climbing the bracket is dangerous of overturning or damage. Families with young children should pay special attention to it.



### Put

Avoid placing the product on an uneven surface or any other unstable place. Otherwise, it will cause the product to fall down, which will lead to the risk of injury.



### Product Mobility

Before moving this product, you must unplug the power cord plug from the wall outlet and pull out all other cables and connecting wires. Otherwise, it will lead to damage of power or connection wires, resulting in fire and electric shock.



### clean

Before cleaning this product, you must unplug the power cord plug from the wall outlet, otherwise there is a risk of fire and electric shock.



### Jack

The socket of this product can only be connected to the designated equipment and devices. Connecting non-designated equipment or devices is dangerous of causing fire and electric shock.



### Location selection

It should be avoided to place the product in the following places, otherwise there is a risk of fire and electric shock.

- High temperature or dusty places.
- Kitchen or other places with lampblack.
- Where the product is exposed to direct sunlight, or any other place where the product will produce high temperature.



### Volume

Don't play music long and loud. Pay special attention when using headphones. Excessive volume can damage your hearing.



### Heavy



Do not place heavy objects on this product. Otherwise, the top of the product will be overweight, causing the product to overturn or drop objects on it, which will lead to the risk of injury.



### Correct assembly of scaffolds

The incorrect assembly of the bracket may overturn, causing the product to fall off and posing a risk of injury to personnel. Therefore, it must be assembled according to the instructions in the attached installation guide to ensure that the product is properly mounted on its bracket.



	<p>Ostrzeżenie — aby zmniejszyć ryzyko obrażeń, użytkownik musi uważnie przeczytać instrukcję obsługi.</p>
	<p>To urządzenie jest zgodne z częścią 15 przepisów FCC. Działanie podlega następującym dwóm warunkom: (1) to urządzenie nie może powodować szkodliwych zakłóceń oraz (2) to urządzenie musi akceptować wszelkie odbierane zakłócenia, w tym zakłócenia, które mogą powodować niepożądane działanie.</p>
	<p>Ten produkt podlega przepisom Dyrektywy Europejskiej 2012/19/WE. Symbol przekreślonego kosza na śmieci oznacza, że produkt wymaga selektywnej zbiórki śmieci na terenie Unii Europejskiej. Dotyczy to produktu i wszystkich akcesoriów oznaczonych tym symbolem. Produktów oznaczonych jako takie nie można wyrzucać razem ze zwykłymi odpadami domowymi, lecz należy je oddać do punktu zbiórki w celu recyklingu urządzeń elektrycznych i elektronicznych</p>

Producent: Shanghaimuxinmuyeyouxiangongsi Adres:

Shuangchenglu 803nong11hao1602A-1609shi, baoshanqu, szanghaj  
200000 CN.

Import do AUS: SIHAO PTY LTD, 1 ROKEVA STREETEASTWOOD NSW  
2122 Australii

Import do USA: Sanven Technology Ltd., Suite 250, 9166 Anaheim Place, Rancho  
Cucamonga, CA 91730



E-CrossStu GmbH

Mainzer Landstr.69, 60329 Frankfurt nad Menem.



YH CONSULTING SPÓŁKA Z OGRANICZONĄ ODPOWIEDZIALNOŚCIĄ.

C/O YH Consulting Limited Office 147, Centurion House,  
London Road, Staines-upon-Thames, Surrey, TW18 4AX



**VEVOR<sup>®</sup>**

**TOUGH TOOLS, HALF PRICE**

Wsparcie techniczne i certyfikat e-gwarancji

[www.vevor.com/support](http://www.vevor.com/support)

# VEVOR®

**TOUGH TOOLS, HALF PRICE**

Technische ondersteuning en e-garantiecertificaat

[www.vevor.com/support](http://www.vevor.com/support)

## **ELEKTRONISCH DRUMSET HANDLEIDING**

**MODEL: MD200F-P**

Wij blijven ons inzetten om u gereedschap te bieden tegen een concurrerende prijs.

"Bespaar de helft", "Halve prijs" of andere soortgelijke uitdrukkingen die door ons worden gebruikt vertegenwoordigt slechts een schatting van de besparingen die u zou kunnen profiteren door bepaalde gereedschappen bij ons te kopen in vergelijking met de grote topmerken en betekent niet noodzakelijkerwijs dat deze alle categorieën gereedschappen dekken door ons aangeboden. U wordt er vriendelijk aan herinnerd om, wanneer u een bestelling bij ons plaatst, zorgvuldig te verifiëren of u daadwerkelijk de helft bespaart in vergelijking met de grote topmerken.

# VEVOR<sup>®</sup>

TOUGH TOOLS, HALF PRICE

## ELEKTRONISCH DRUMSET

MODEL: MD200F-PF

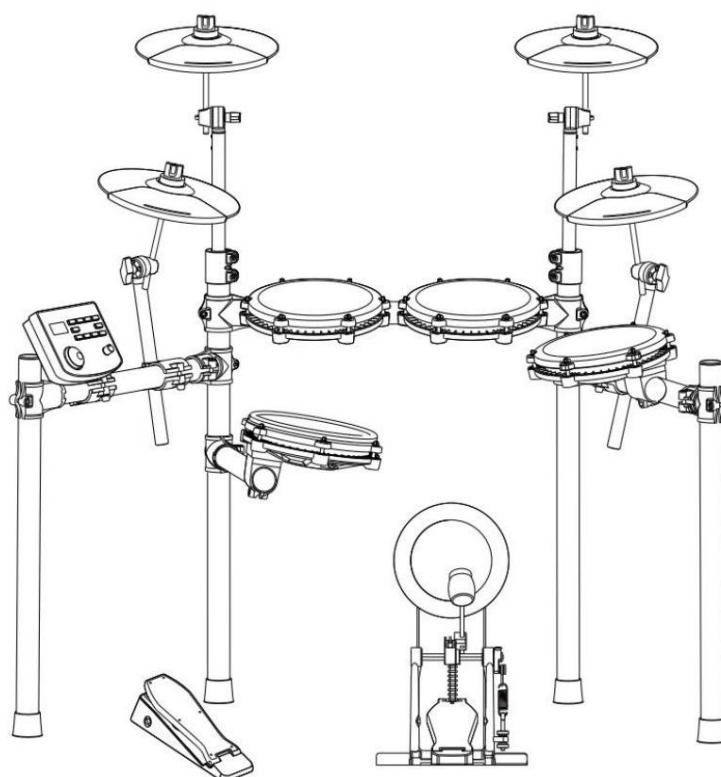

(De afbeelding is alleen ter referentie, raadpleeg het werkelijke object )

**HULP NODIG? NEEM CONTACT MET ONS OP!**

Heeft u productvragen? Technische ondersteuning nodig? Voel je vrij om  
neem contact

met ons op: **Technische ondersteuning en e-garantiecertificaat**  
**[www.vevor.com/support](http://www.vevor.com/support)**

Dit is de originele instructie. Lees alle instructies in de handleiding zorgvuldig  
door voordat u ermee aan de slag gaat. VEVOR behoudt zich een duidelijke  
interpretatie van onze gebruikershandleiding voor. Het uiterlijk van het product  
is afhankelijk van het product dat u heeft ontvangen. Vergeef ons alstublieft dat we u  
niet opnieuw informeren als er technologie- of software-updates zijn voor ons product.



## FUNCTIE INLEIDING

Bedankt dat u voor onze elektronische drum hebt gekozen. Elegante en delicate elektronische drum is de perfecte combinatie van moderne nieuwe elektronische technologie. •Voordat u dit product gebruikt, moet u de instructies in detail lezen.

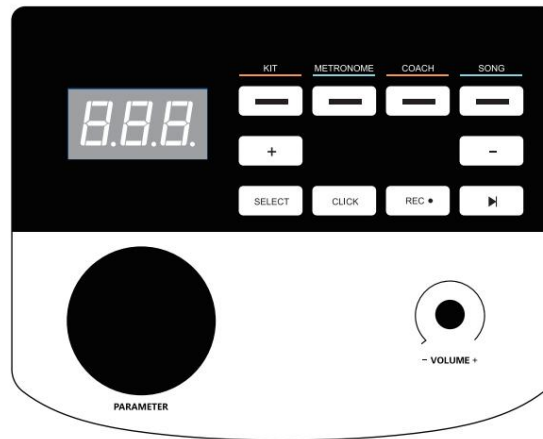

- 32 drumsets, 480 timbres
- 30 nummers
- Ondersteuning van de aanpassing van de gevoeligheidsparameters van elke drum
- Drie leermodi
- Snelheidsregeling: 30 ~ 250 slagen/min
- Metronoom: 1-9 typen
- Overige functies: parameteropslag, reset en opname;
- driebijferig led-display;
- interface: voeding dc, usbmidi, oortelefoon, audio-ingang, audio-uitgang

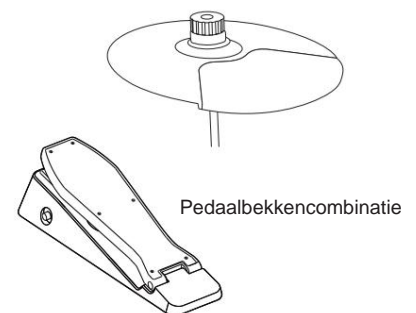
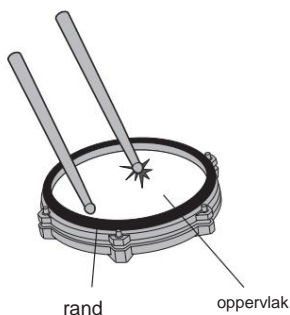

### OPMERKING!

- Dit product is een elektro-akoestisch instrumentproduct. Het is normaal dat er na het inschakelen een beetje geluid uit de luidspreker of oortelefoon komt.  
Houd tijdens gebruik de buurt van "radio, TV, antenne-ontvanger, router, koelkast, TV, motor en andere RF-elektrische interferentiebronnen".



# INHOUD

<b>FUNCTIE INLEIDING</b>	<b>1</b>
<b>INHOUD</b>	<b>2</b>
<b>INSTALLATIE GIDS</b>	<b>3</b>
CONTROLEER DE BIJGEVOEGDE ITEMS	3
LRON PIJPHOUDER	4
TYMPANISCHE INTUBATIE	4
MONTAGESTANDAARD	5
INSTALLEER DE DRUMMODULE	5
INSTALLEER SLAANONDERDELEN EN GELUIDSMODULE	6
INSTALLEER DE KICKDRUM	7
INSTALLEER DE HAMERSTAAF	7
DE KICKDRUM WORDT VASTGESTELD MET DE STAPHAMER	7
STEEK HET OPVALLENDE DEEL AAN. VERBINDINGSKABEL	7
<b>ILLUSTRATIE VAN GELUIDSMODULEPOORT</b>	<b>8</b>
AANSLUITING VAN HET STROOMKABEL	8
USB MIDI-POORT	8
AUDIO-UITVOERPOORT	8
AUDIO-INVOLVOERPOORT	8
OORTELEFOONPOORT	8
HAVEN VERHOGEN	8
BT-MODUS	8
<b>BEDIENINGSHANDLEIDING</b>	<b>9</b>
STROOM	9
DRUMKIT SELECTIE	9
METRANOOM	9
PRAKTIJKFUNCTIE	9
COACHMODUS	9
DEMO-NUMMERS	10
TROMMELPARAMETERS	10
OPNAMEFUNCTIE	10
OPSLAAN / RESETTEN	10
USB-MIDI	11
<b>BIJLAGE</b>	<b>11</b>
TIMBRE	11
VOORAF INGESTELDE DRUMKITS	11
DOOR GEBRUIKER GEDEFINIEERDE DRUMKITS	11
DEMOSTRATIE NUMMER	11
<b>PRODUCTONDERHOUD</b>	<b>12</b>
<b>VEILIGHEIDSMATREGELEN</b>	<b>13</b>



# INSTALLATIE GIDS

## OPMERKING!

- Volg de instructies en lees de "veiligheidsmaatregelen" in de gebruikershandleiding aandachtig voor gebruik .
- Dit product moet door een volwassene worden geïnstalleerd. Laat de minderjarige het niet zelfstandig installeren.

# 01

## Controleer de bijgevoegde items

- Controleer na het openen van de verpakking onmiddellijk of alle artikelen erin zitten. Als er omissies zijn, neem dan contact op met uw dealer.



Geluidsmodule



Modulebeugel

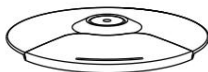

Cimbaal \*4

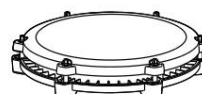

Tom (3 stuks)



Strik



Achtersteun



Verbindingsbeugel



Voorbeugel



Trap

2 STUKS 2 STUKS 6 STUKS



schroef

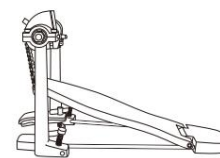

Trappedaal



Bekkenarm  
(4 stuks)



Hihat-pedaal



Bout bestuurder



Signaalverbindingkabel



Drum sleutel



Oplader



Drumstok



Stok hamer



## MONTAGE TEKENING

### 02

### ijzeren pijphouder

•De standaard bevindt zich in een klein individueel pakketje in de doos.

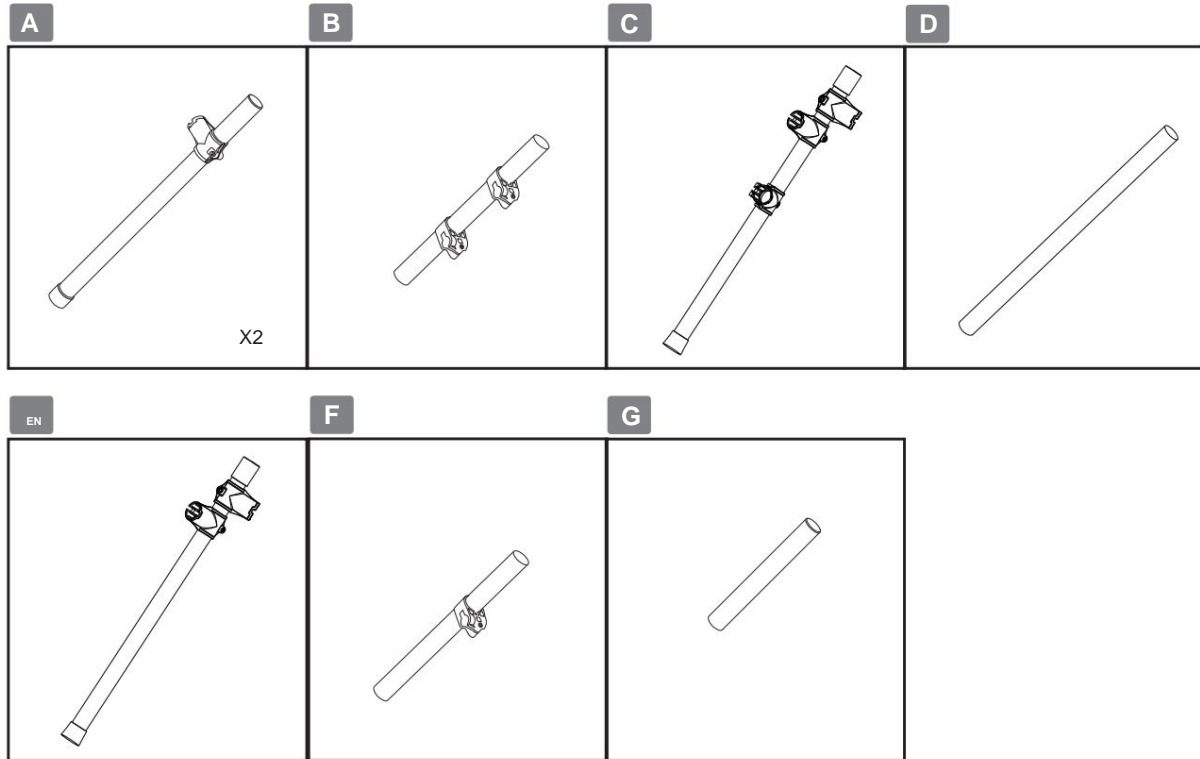

### 03 Trommelintubatie

Installeer de trommel op de trommelsteunbalk.

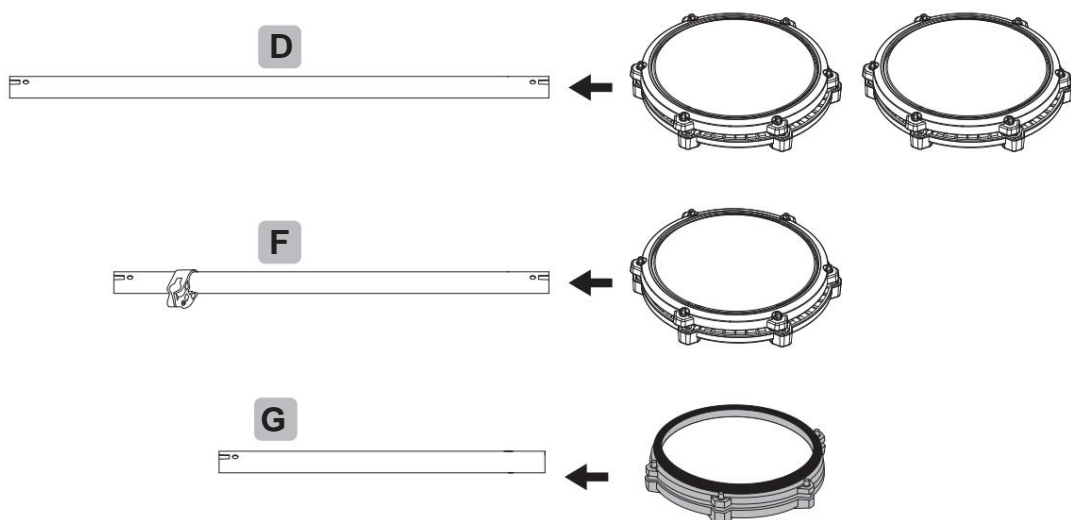



## INSTALLATIE GIDS

### 04

#### Montagestandaard

- Draai tijdens de installatie de schroeven vast en zorg ervoor dat uw vingers niet bekneld raken.
- Monteer de beugel in de aangegeven richting

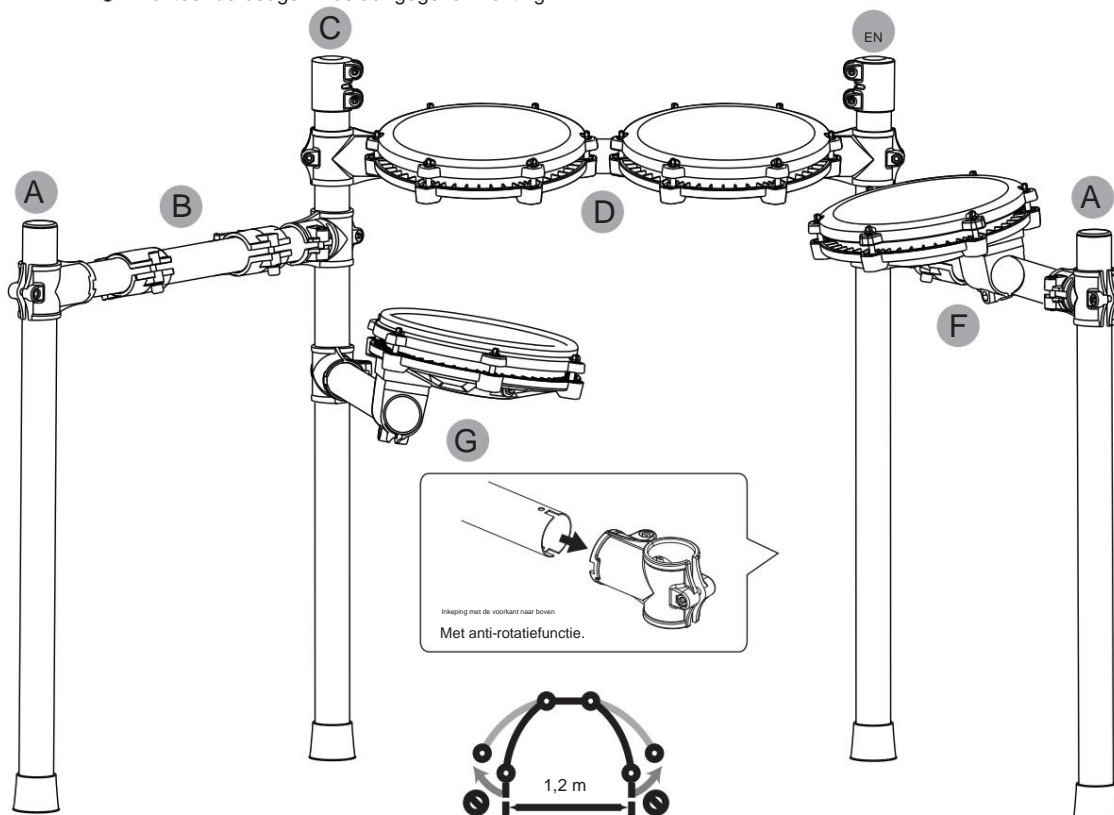

Om veiligheidsredenen mag de uitzetbreedte van de steun niet groter zijn dan 1,2 meter.

### 05

#### Installeer de drummodule

- Plaats deze tijdens het stallen op zijn plaats.

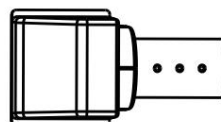
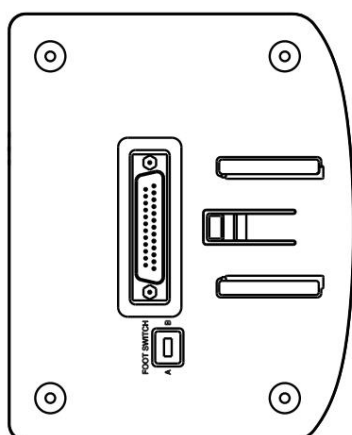

Lijn de mainframe-drummodule uit met de rail van de mainframekast en plaats deze.

Nadat je hem tot op de bodem hebt geplaatst, hoor je de klikstukken omhoog komen.



# INSTALLATIE GIDS

## 06

### Installeer de rakende onderdelen en de geluidsmodule

- Draai de schroeven vast nadat de trommel is geplaatst om losraken te voorkomen.
- Zorg ervoor dat u het bekken niet te strak vastdraait, maar zorg ervoor dat er wat ruimte overblijft zodat ze op en neer kunnen slingeren.

Verwijder de moeren en cirkelkussens van de drie bekkenarmen, plaats de drie bekkens in de overeenkomstige arm en schroef de moeren vast. Plaats respectievelijk 3 vaten en 1 vat in de overeenkomstige steunstang en draai de schroeven vast. Let op: de functies van elk bekken, tomdrum en snaredrum zijn verschillend, dus het is noodzakelijk om de accessoire-identificatie te raadplegen voor de juiste installatie!

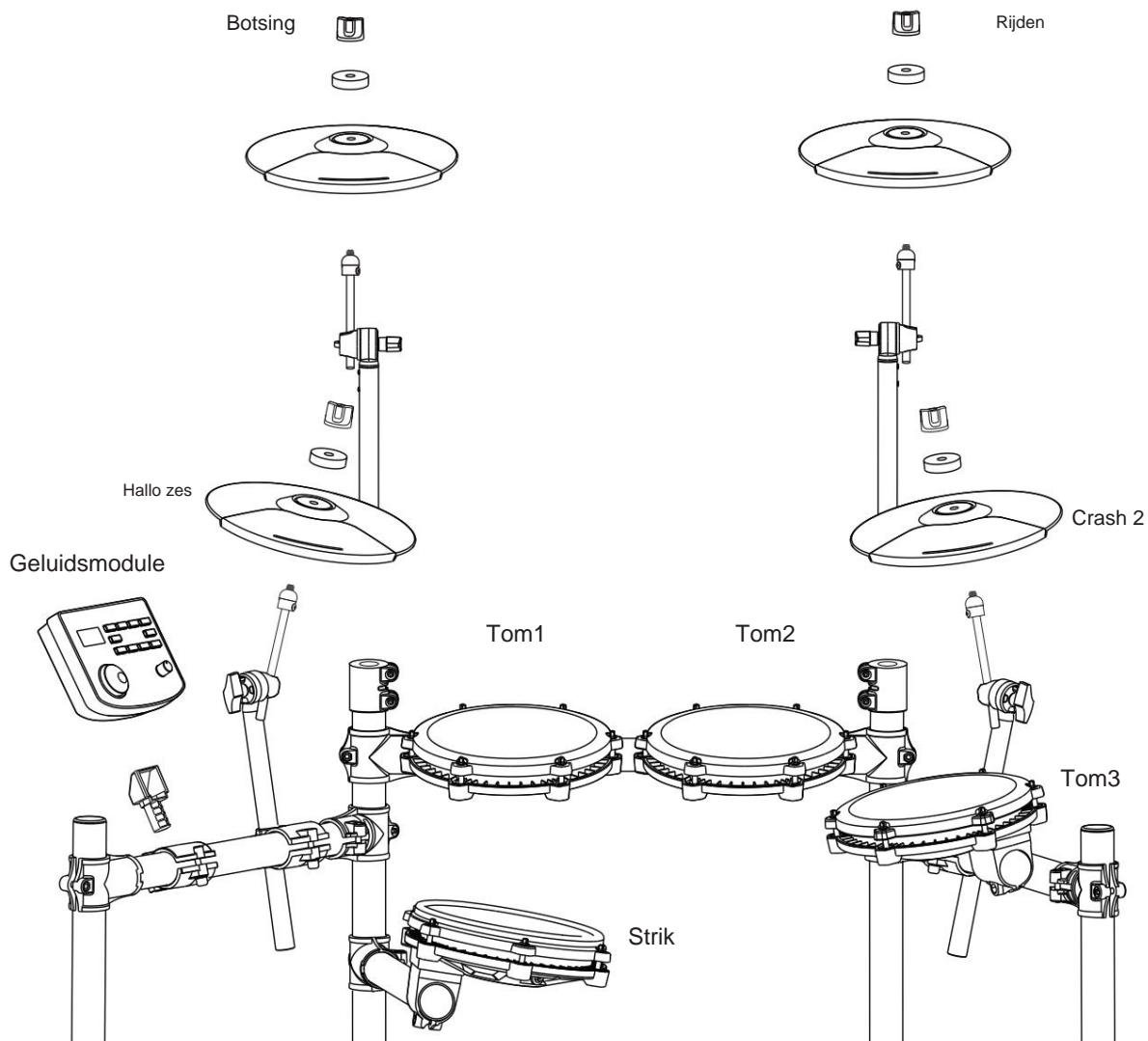



## INSTALLATIE GIDS

### 07

#### Installeer de kickdrum

- Draai bij het installeren de schroeven vast en zorg ervoor dat uw vingers niet bekneld raken.

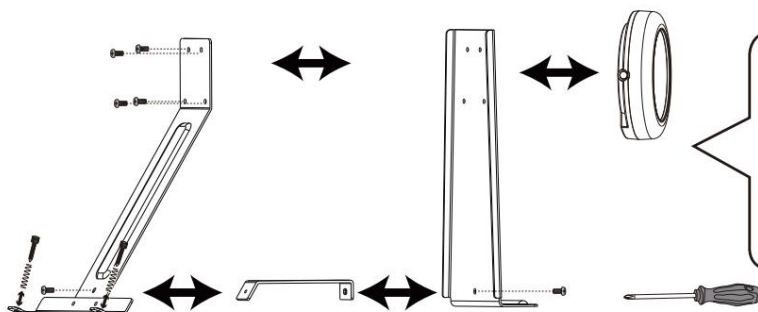

Gebruik een schroevendraaier om de onderste trommel te bevestigen, met de bevestigingen zoals afgebeeld, steundelen met 6 kleine schroeven. Plaats vervolgens 2 veren in 2 antislipschroeven en vergrendel de 2 veren in de onderkant van het steunstuk totdat deze op de grond rust.

### 08

#### Installeer de hamerstang

- de paal moet in kant worden gestoken en de schroeven moeten worden vastgedraaid om losraken te voorkomen.

Steek de hamerstaaf in het ronde gat zoals weergegeven in de afbeelding, draait u de wolhamer om deze uit te lijnen met het trommeloppervlak, en draai hem dan vast met de drumsleutel.

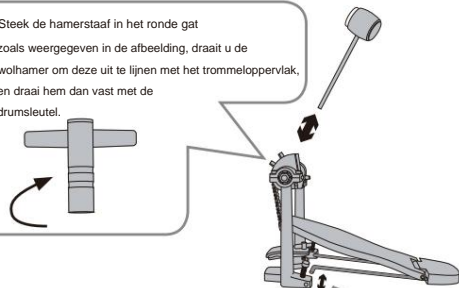

Steek de vaste ijzeren staaf in het gat zoals weergegeven in de afbeelding.

### 09

#### De kickdrum wordt vastgezet met de stappenhamer

- de onderste trommel en de traphamer moeten worden vastgezet en vastgedraaid om te voorkomen dat u eraf valt.

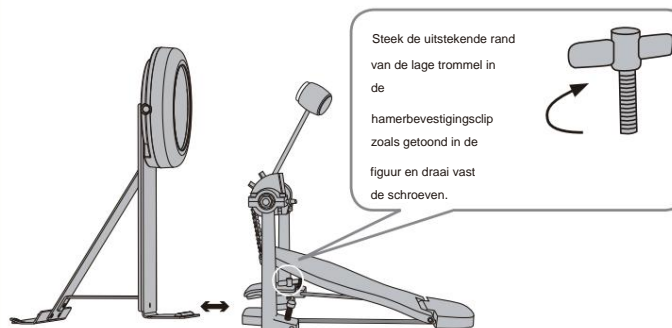

Steek de uitstekende rand van de lage trommel in de hamerbevestigingsclip zoals getoond in de figuur en draai vast de schroeven.

### 10

#### Sluit de aansluitkabel van het opvallende deel aan

- Steek de verbindingkabel op zijn plaats om slecht contact te voorkomen en steek deze op de juiste manier in, zoals weergegeven in het diagram.

Controleer of de onderste trommel geluid maakt. Als er geen geluid is, zet dan de schakelaar:  
Schakelaar in A: mechanische kickdrummodus  
Schakelaar in B: pedaalmodus.

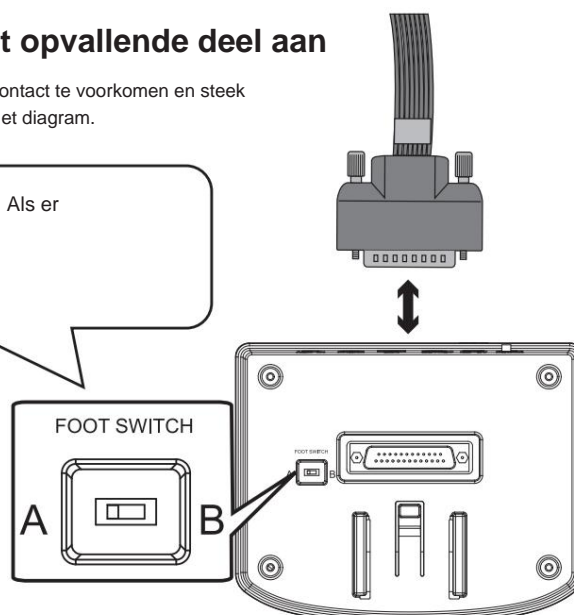



## ILLUSTRATIE VAN GELUIDSMODULEPOORT

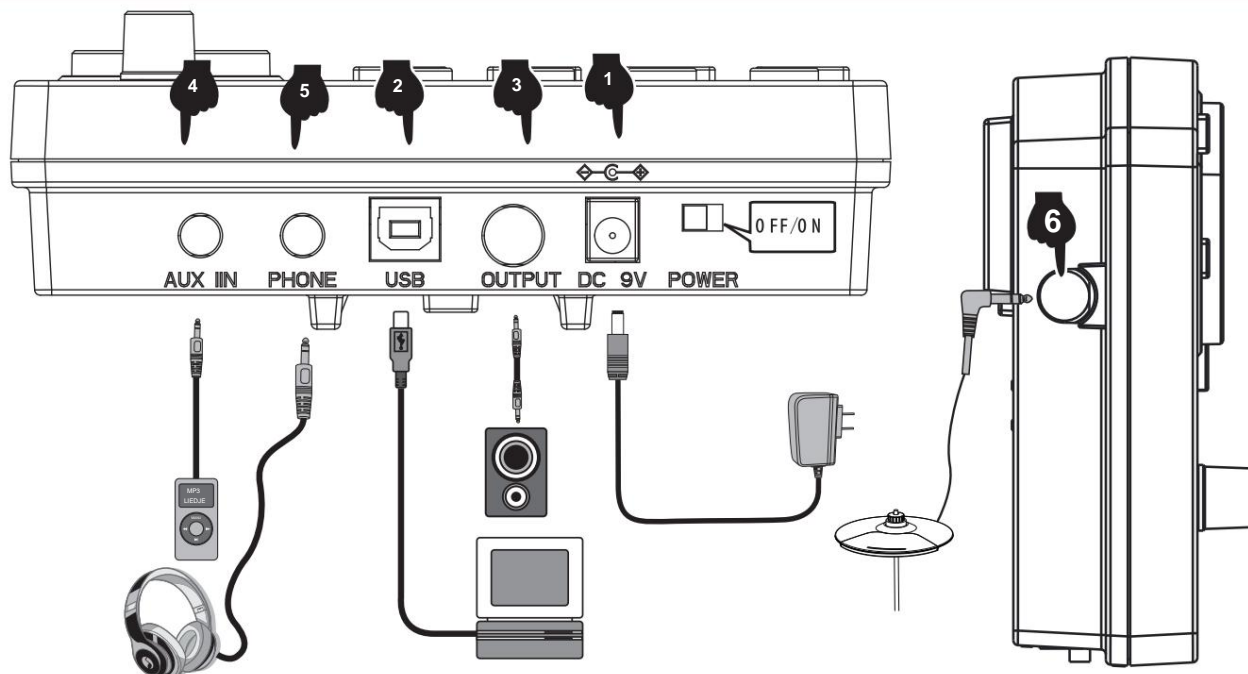

### 1 STROOMKABELAANSLUITING

1. Sluit tijdens gebruik de voedingsterminal aan volgens het diagram en steek het stopcontact van de geluidsmodule in aan de ene kant en een stopcontact van 100-240V aan de andere kant. (Figuur 1)
2. Als u dit product langere tijd niet gebruikt, trek dan de stekker uit het stopcontact en bewaar deze op de juiste manier.

### 2 USB MIDI-POORT

Het gebruik van een elektronische drum MIDI USB-interface kan communiceren met muziekapparaten met MIDI.

1. Via de vooraf geïnstalleerde muzieksoftware op computers en mobiele telefoons kunnen we leren spelen en componeren muziek, winkel en andere functies. (Fig. 2)
2. Wanneer aangesloten op een computer of mobiele telefoon, moet de audio-uitgang van het apparaat worden aangesloten op de audio-ingang van de modulebox om de geluidseffecten op het apparaat te synchroniseren. (Afb. 5)

### 3 AUDIO-UITVOERPOORT

De audio-uitgang kan worden aangesloten op een actieve luidspreker (speciale elektronische drumluidspreker) en grote audioapparatuur. (Afb. 3)

### 4 AUDIO-INGANGSPOORT

De audio-invoerpoort kan het afspeelapparaat voor de geluidsbron aansluiten op de modulebox voor weergave (zoals MP3, mobiele telefoon) en andere audiosignaalvoer). (Afb. 4)

### 5 OORTELEFOONPOORT

Als u een hoofdtelefoon aansluit, worden de details van de percussie gecontroleerd en worden anderen niet gestoord als u speelt zonder verbinding te maken luidsprekers. (Afb. 5)

### 6 VERHOOG HAVEN

Via deze poort kunt u een bekken toevoegen voor eenvoudige uitbreiding. (Figuur 6)



# BEDIENINGSGIDS

## 1 VERMOGEN

Steek de DC-stekker in de DC 9V-poort aan de bovenkant van de besturingseenheid. Schuif de POWER-schakelaar naar rechts (gezien vanaf de voorkant) om de drumkit aan te zetten. Om de drumkit uit te schakelen, schuift u de schakelaar naar links.

## 2 DRUMKIT-SELECTIE

Druk op de KIT-knop om de huidige drumkit weer te geven. Draai aan het parameterwiel of gebruik de knoppen <- /+> om de gewenste parameter te selecteren drumkit. Er zijn 32 drumkits om uit te kiezen - zie de drumkitlijst op pagina 11.

## 3 METRONOOM

- Druk op de METRONOME-knop om naar de metronoommodus te gaan.
- Het scherm geeft de snelheidswaarde weer (standaardsnelheid 120 BPM). Draai aan het parameterwiel of gebruik de +/- knoppen om verander de metronoomsnelheid. Druk op de CLICK-knop om de metronoom te starten.
- Druk in de metronoommodus op de SELECT-knop. Het scherm springt naar de aanpassing van de metronoomparameters interface. U kunt op de +/- knoppen drukken om de parameter te selecteren die u wilt aanpassen:
  - A. r (beattype: 2,4,8,16)
  - B. b (telnummer: 01-09)
  - C. L (metronoomvolume: 00 (uit) -31), en draai vervolgens aan het parameterwiel om de parameterinstellingen aan te passen.
- Zodra de parameters zijn aangepast, drukt u op de SELECT-knop om te bevestigen en de parameterinterface te verlaten gebruik de CLICK-knop om de metronoom naar wens te starten en stoppen.

## 4 OEFENFUNCTIE

De 'coach'-coachmodus van dit product kan helpen bij het vaststellen van snelheid, nauwkeurigheid en uithoudingsvermogen, en helpt bij het cultiveren van de oefenfunctie van een beter ritmegevoel. Boek vooruitgang onder toezicht van de coachmodus!

Druk op de knop "coach" om naar de coachmodus te gaan. In deze modus zijn er drie oefenmodi. Selecteer de praktijk via het datawiel of de knop <+ > <- >.

- Oefenmodus 1: C-1 slagdetectieoefening: sla op de trommel met een vaste snelheid om de nauwkeurigheid van de slag te trainen.
- Oefenmodus 2: C-2 stille slagmodus: de metronoom laat één sectie klinken en dempt één sectie om de slagnauwkeurigheid zonder metronoomprompt. Het is een geavanceerde versie van oefenmodus 1.
- Oefenmodus 3: C-3 snelheidsoefening, de metronoom verandert automatisch de snelheid en verhoogt van de langzaamste express naar de snelste, en dan terug te brengen van de langzaamste express naar de langzaamste snelheid, zoals om het uithoudingsvermogen van de staking te oefenen.

## 5 COACHMODUS

- De trainingsmodus "coach" van dit product kan helpen bij het vaststellen van snelheid, nauwkeurigheid en uithoudingsvermogen. Druk op COACH om naar de coachmodus te gaan. In deze modus zijn er drie oefenmodi. Gebruik het parameterwiel om te selecteren welke oefenmodus.
  - A. Oefenmodus 1: C-1 oefening voor slagdetectie - sla op de trommel met een vaste snelheid om de nauwkeurigheid van de slag te trainen.
  - B. Oefenmodus 2: C-2 stille slagmodus - de metronoom laat één sectie klinken en dempt één sectie om te trainen als er geen beat is.
  - C. Oefenmodus 3: C-3 speed strike oefenen - de metronoom verandert automatisch de snelheid van de langzaamste naar de snelste en dan van de snelste naar de langzaamste.
- Zodra de coachingmodus is gekozen, drukt u op de KLIK-knop. De metronoombeats beginnen en dat kun je doen speel mee op de drum om te oefenen.
- Na vier voorbereidende tellen toont het display:

(te traag)



(Goed)



(te snel)





## BEDIENINGSGIDS

4. Zodra u de coachingmodus heeft voltooid, wordt er een score weergegeven van 0-100, waarbij de nauwkeurigheid van de oefening.

C-1-modus: Druk op de SELECT-knop om de parameterinstellingsinterface te openen. U kunt het aantal oefeningen aanpassen sessies naar behoefte (01-32). Het aantal te oefenen sessies bepaalt de lengte van deze oefening.

C-2-modus: Druk op de SELECT-knop om de parameterinstellingsinterface te openen. Je kunt het aantal oefensessies naar wens aanpassen (04-32). Het aantal te oefenen sessies bepaalt de lengte van deze oefening.

C-3-modus: Druk op de SELECT-knop om de parameterinstellingsinterface te openen. U kunt de snelheid waarmee de BPM wordt aangepast aanpassen wijzigingen (01-09 BPM).

5. Druk nogmaals op de CLICK-knop om de coachmodus te beëindigen.

### 6 DEMO-SONGS

1. Druk op de SONG-knop om naar de demomodus te gaan. Er zijn 30 demo's om uit te kiezen. Het scherm geeft de huidige weer demosongnummer (01 -30).

2. Druk op de <> knop om het afspelen van de demosongs te starten. Om het afspelen te stoppen, drukt u nogmaals op de knop <>.

3. Draai aan het parameterwiel of druk op de +/- knoppen om een demosong te selecteren.

4. Druk in de songmodus op de SELECT-knop om naar de interface voor het instellen van de songparameters te gaan. U kunt het drumgeluid aanzetten of uit door aan het parameterwiel te draaien (het drumgeluid staat standaard aan).

5. Druk op de SELECT-knop om te bevestigen en de parameterinterface te verlaten.

### 7 TROMMELPARAMETERS

1. Druk op de KIT-knop en het scherm geeft 01 (drumkitnummer) weer. Druk op SELECT om de drumparameter in te voeren aanpassingsmodus.

2. Tik op de drum die u wilt aanpassen en druk vervolgens op de +/- knoppen om de parameter voor aanpassing te selecteren. Gevoeligheid

A. S(01-06). Triggerdrempel t(01 - 32).

Overspraakdrempel c (01 -32)

B. Herhaalde trigger r(01-32) Drumkracht

V(01-03). Drumvolume L (00 - 31).

3. Wijzig de parameters door aan het parameterwiel te draaien en druk lang op de knop - om op te slaan. Het scherm met display SAV om aan te geven dat de parameteraanpassing succesvol is opgeslagen.

4. Om de drumparameters terug te zetten naar de fabrieksinstellingen, drukt u lang op de knop + totdat het scherm RES weergeeft.

5. LET OP: De parameters voor de 3 tomdrums kunnen niet afzonderlijk worden ingesteld.

### 8 OPNAMEFUNCTIE

1. Druk op de knop < REC > wanneer het indicatielampje in de statussen "KIT" en "CLICK" staat, en het scherm toont de woorden "REC" in de ademende knipperende staat en gaan naar de opnamevoorbereidingsstatus.

2. Tik op een willekeurige drum en de metronoom klinkt. Op dit moment wordt op het scherm "---" weergegeven terwijl de ademhaling knippert en begint met opnemen.

3. Druk nogmaals op de < REC > toets of < PLAY > toets, de opname stopt en "A-1" wordt op het scherm weergegeven.

4. Druk op < ▶ | > om de huidige opname af te spelen, en druk nogmaals om het afspelen te stoppen.

5. Als u zonder kloppen weer in de opnamevoorbereidingsstatus komt, wordt de laatst opgenomen "A-1" afgespeeld.

### 9 OPSLAAN / RESETTEN

1. Om de parameters op te slaan, drukt u lang op de <> knop. Het scherm geeft SAV weer.

2. Om de parameters te resetten, drukt u lang op de knop <+>. Het scherm geeft RES res weer.

### 10 USB-MIDI

Om de MID-functie van de drumkits te gebruiken, sluit u een USB-B-datakabel (niet meegeleverd bij deze drumkit) aan op de bedieningseenheid en maakt u verbinding met pc/smartphone.





## APPENDIX

400 . Akoestisch hihatpedaal		433 . Ziesiecrash 2	450 . Fuck Crash2 Rim	467 . Blues Crash2-rand
401 . Seesion hihatpedaal	417 . Popcrash 2	434 . Moderne crash2	451 . Harde Crash2-rand	468 . Klassieke Crash2-velg
402 . Modern hihatpedaal	418 . Fuck Crash2	435 . Bluescrash2	452 . Originele Crash2 velg	469 . Synthgaze Crash2-rand
403 . Blues hihatpedaal 404.	419 . Harde crash2	436 . Klassieke crash2	453 . PopRock Crash2 Rijm	470 . Freak Crash2-rand
Klassiek hihatpedaal 405.	420 . Originele Crash2	437 . Synthgaze-crash 2	454 . Rock Crash2-rand	471 . Sticks Crash2-rand
Synthgaze hihatpedaal	421 . PopRock-crash2	438 . Freakcrash2	455 . Metalen Crash2 velg	472 . Grunge Crash2-rand
406 . Freak hi-hatpedaal	422 . Rotscrash2	439 . Sticks-crash2	456 . PowerMetal Crash2 velg	473 . Crash2-velg uit de jaren 70
407 . Sticks Hi-Hat-pedaal	423 . Metaalcrash2	440 . Grunge-crash 2	457 . SpeedMetal Crash2 velg	474 . Crash2-velg uit de jaren 80
408 . Grunge hi-hatpedaal	424 . PowerMetal-crash2	441 . Crash uit de jaren 702	458 . PopJazz Crash2 Rim	475 . Populaire Crash2-velg
409 . Hihatpedaal 410 uit	425 . SpeedMetal Crash2	442 . Crash uit de jaren 802	459 . Jazz Crash2-rand	476 . Slam Crash2-rand
de jaren 70. Hi-hatpedaal	426 . PopJazz Crash2	443 . Populaire Crash2	460 . 808	477 . Crash2-rand aanvallen
uit de jaren 80 411. Populair	427 . Jazzcrash2	444 . Slam-crash 2	461 . 909	478 . Oude Crash2 velg
hihatpedaal 412. Slam hi-	428 . 808	445 . Aanvalscrash2	462 . Songo Crash2-rand	479 . Fairfax Crash2 velg
hatpedaal 413 . Attack-	429 . 909	446 . Oude crash2	463 . Standaard Crash2 velg	480 . Militaire Crash2-rand
hihatpedaal 414 . Oud	430 . Songo-crash 2	447 . Fairfax-crash2	464 . Akoestische Crash2 Rim	
hihatpedaal 415. Fairfax	431 . Standaard crash2	448 . Militaire crash2	465 . Seesion Crash2 velg	
hihatpedaal 416. Militair hihatpedaal	432 . Akoestische crash2	449 . Pop Crash2-rand	466 . Moderne Crash2-velg	

Crash 2

### Drum combination timbre

01 Pop	09 SpeedMetaal
02 Neuken	10 PopJazz
03 Moeilijk	11 Jazz
04 Origineel	12 808
05 Poprock	13 909
06 Rots	14 Songo
07 Metaal	15 Standaard
08 PowerMetaal	16 Akoestisch

### User drum group

17 Seesie	25 jaren '70
18 Moderne	26 jaren 80
19 blauw	27 Populair
20 Klassiek	28 Slag
21 Synthgaze	29 Aanval
22 Freak	30 Oud
23 Stokken	31 Fairfax
24 Grunge	32 Militair

### Demonstration music

Lied 001	Lied 007	Lied 013	Lied 019	Lied 025
Lied 002	Lied 008	Lied 014	Lied 020	Lied 026
Lied 003	Lied 009	Lied 015	Lied 021	Lied 027
Lied 004	Lied 010	Lied 016	Lied 022	Lied 028
Lied 005	Lied 011	Lied 017	Lied 023	Lied 029
Lied 006	Lied 012	Lied 018	Lied 024	Lied 030



## PRODUCTONDERHOUD

Zorgvuldig onderhoud en bescherming van dit product spelen een zeer belangrijke rol bij het verlengen van de levensduur van het product en het verminderen van storingen.

#### 1 Vermijd hitte, vocht of direct zonlicht

Stel het product niet te veel bloot aan direct zonlicht en plaats het niet in de buurt van de airconditioner of op een extreem warme plaats.

#### 2 Niet gebruiken in de buurt van tv of radio

Dit product kan video- of audio-interferentie veroorzaken bij de ontvangst van tv en radio. Als dit gebeurt, verwijdt u het product van de tv of radio.



## PRODUCTONDERHOUD

### 3 Gebruik geen verf, verdunner of soortgelijke chemicaliën voor het reinigen

Gebruik een zachte, vuilvrije reinigingsdoek gedrenkt in een kleine hoeveelheid water of een speciaal schoonmaakmiddel om de oppervlaktevlekken van dit product te verwijderen.

### 4 Schud niet om botsingen te voorkomen

Wanneer u het product verplaatst, moet u er voorzichtig mee omgaan. Hevige trillingen en botsingen zijn ten strengste verboden om schade aan de schaal of interne elektronische componenten te voorkomen.



## SAFETY PRECAUTIONS

### POWER SUPPLY

This product can be powered by standard indoor wall sockets. Please only use the power cord specified in this product. When not in use, please turn off the power supply. When not in use for a long time, pull out the power cord and keep it properly.

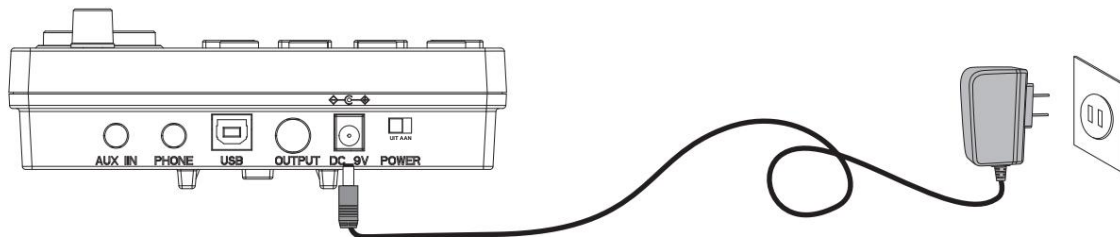

### SIGN

To ensure that you use this product safely and correctly, to prevent harm to users and others and financial damage, this manual and products are marked with a series of safety signs. The various signs and their meanings are as follows:

#### **WARNING**

This sign indicates that there is a potential risk of death or serious injury if this mark is ignored and the product is mishandled.

#### **BE CAREFUL**

This sign indicates that there is a potential danger of injury to personnel or other financial damage if this sign is ignored and the product is operated incorrectly.

### EXAMPLE OF LOGO



This triangle sign ( $\Delta$ ) indicates what users should pay attention to. (The left example is careful shocks)



A circular sign ( $\ominus$ ) with an oblique line indicates prohibitions. The icons in or beside the logo indicate the contents specifically prohibited. (The example on the left is no disassembly)



The round black bottom sign ( $\oplus$ ) indicates what must be observed. The diagrams in this sign indicate the contents of the specific matters that must be observed. (The example on the left is that the power plug must be pulled out of the socket)



## SAFETY PRECAUTIONS

### **WARNING**

#### **Smoke, odor, overheating**

When the product smokes, smells or overheats, there is a danger of fire and electric shock when it is used continually. In case of the above situation, the following operations should be performed immediately:

1. Turn off the power supply.
2. Pull the plug out of the power outlet.
3. Contact your dealer.

#### **Power cord**

1. The improper use of power cord may cause fire and electric shock. The following precautions must be observed:
  - The special power cord designated for this product must be used.
  - The AC power supply with output voltage within the rated voltage range for household use must be used.
  - Do not overload power sockets and extension lines.
2. The improper treatment of power line will lead to its damage or breakage, which will cause fire and electric shock hazards. The following precautions must be observed:
  - Do not place or heat heavy objects on power lines.
  - Do not attempt to alter or bend the power cord too much.
  - Do not twist or pull the power cord.
  - If the power cord or plug is damaged, please replace the same type of power cord.
3. Do not touch the power cord and plug with wet hands, otherwise there is a danger of electric shock.
4. Please use the power cord where the water will not splash. Water is in danger of causing fire and electric shock.
5. Never place vases or any other container containing water on this product. Water is dangerous of causing fire and electric shock.
6. Do not allow minors to unplug and touch power lines or connection boards. Minors have no common sense of electricity safety, which may cause electric shock.

### **BE CAREFUL**

The improper use of power cord may cause fire and electric shock. The following precautions must be observed:

- Never put the power cord near the oven or other heat source.
- Do not pull the cable when pulling out of the power socket. The main body of the plug must be grasped.
- The power cord plug must be inserted in the socket to the end.
- Make sure the power supply is off before connecting or disconnecting it.
- When thunderstorms occur or before traveling or other long-term departure, disconnect the power cord from the wall outlet.
- At least once a year, remove the power cord from the wall outlet and clean the dust accumulated around the plug.

#### **Do not burn this product**

Do not put this product in the fire, otherwise it will lead to product combustion and explosion of internal electronic components, which will cause fire and personnel injury.

#### **Water and foreign bodies**

Water, other liquids and (metal sheets, etc.) entering this product are in danger of causing fire and electric shock. In case of the above situation, the following operations shall be performed immediately:

1. Turn off the power supply.
2. If you are using a power cord for power supply, unplug it from the wall outlet.
3. Contact your distributor.

#### **Disassembly and transformation**

Do not disassemble or transform the product in any way, otherwise there is a risk of electric shock, scald or other personal injury. All internal inspection, adjustment and maintenance operations should be entrusted to your distributor.



## SAFETY PRECAUTIONS

### Falling or colliding

If the product falls or is damaged by strong impact, it will be in danger of causing fire and electric shock. In case of the above situation, the following operations shall be performed immediately:

1. Turn off the power supply.
2. If you are using a power cord for power supply, you need to unplug it from the wall outlet.
3. Contact your distributor.



### Plastic bag

Do not let anyone put plastic bags for this product on his head or in his mouth. Otherwise, there is a risk of asphyxia. Families with young children should pay special attention to it.



### Keep a distance from the product and the bracket

Climbing the bracket is dangerous of overturning or damage. Families with young children should pay special attention to it.



### Put

Avoid placing the product on an uneven surface or any other unstable place. Otherwise, it will cause the product to fall down, which will lead to the risk of injury.



### Product Mobility

Before moving this product, you must unplug the power cord plug from the wall outlet and pull out all other cables and connecting wires. Otherwise, it will lead to damage of power or connection wires, resulting in fire and electric shock.



### clean

Before cleaning this product, you must unplug the power cord plug from the wall outlet, otherwise there is a risk of fire and electric shock.



### Jack

The socket of this product can only be connected to the designated equipment and devices. Connecting non-designated equipment or devices is dangerous of causing fire and electric shock.



### Location selection

It should be avoided to place the product in the following places, otherwise there is a risk of fire and electric shock.

- High temperature or dusty places.
- Kitchen or other places with lampblack.
- Where the product is exposed to direct sunlight, or any other place where the product will produce high temperature.



### Volume

Don't play music long and loud. Pay special attention when using headphones. Excessive volume can damage your hearing.



### Heavy

Do not place heavy objects on this product. Otherwise, the top of the product will be overweight, causing the product to overturn or drop objects on it, which will lead to the risk of injury.



### Correct assembly of scaffolds

The incorrect assembly of the bracket may overturn, causing the product to fall off and posing a risk of injury to personnel. Therefore, it must be assembled according to the instructions in the attached installation guide to ensure that the product is properly mounted on its bracket.



	<p>Waarschuwing-Om het risico op letsel te verminderen, moet de gebruiker de handleiding zorgvuldig lezen.</p>
	<p>Dit apparaat voldoet aan Deel 15 van de FCC-regels. Het gebruik is onderworpen aan de volgende twee voorwaarden: (1) Dit apparaat mag geen schadelijke interferentie veroorzaken, en (2) dit apparaat moet alle ontvangen interferentie accepteren, inclusief interferentie die een ongewenste werking kan veroorzaken.</p>
	<p>Dit product valt onder de bepalingen van de Europese richtlijn 2012/19/EG. Het symbool met een doorgestreepte afvalcontainer geeft aan dat het product in de Europese Unie een aparte afvalinzameling vereist. Dit geldt voor het product en alle accessoires die met dit symbool zijn gemarkeerd. Producten die als zodanig gemarkeerd zijn, mogen niet met het normale huisvuil worden weggegooid, maar moeten naar een inzamelpunt voor recycling van elektrische en elektronische apparaten worden gebracht</p>

**Fabrikant:** Shanghaimuxinmuyeyouxiangongsi **Adres:**

Shuangchenglu 803nong11hao1602A-1609shi, baoshanqu, shanghai  
200000 CN.

**Geïmporteerd naar AUS:** SIHAO PTY LTD, 1 ROKEVA STREETEASTWOOD NSW  
2122 Australië

**Geïmporteerd naar de VS:** Sanven Technology Ltd., Suite 250, 9166 Anaheim  
Place, Rancho Cucamonga, CA 91730



E-CrossStu GmbH  
Mainzer Landstr.69, 60329 Frankfurt am Main.



YH CONSULTING LIMITED.  
C/O YH Consulting Limited Kantoor 147, Centurion House,  
London Road, Staines-upon-Thames, Surrey, TW18 4AX



**VEVOR**<sup>®</sup>

**TOUGH TOOLS, HALF PRICE**

Technische ondersteuning en e-  
garantiecertificaat [www.vevor.com/support](http://www.vevor.com/support)

# VEVOR®

## TOUGH TOOLS, HALF PRICE

Teknisk support och e-garanticertifikat

[www.vevor.com/support](http://www.vevor.com/support)

### ELEKTRONISKT TRUMSET

### ANVÄNDARMANUAL

MODELL: MD200F-P

Vi fortsätter att vara engagerade i att ge dig verktyg till konkurrenskraftiga priser.

"Spara halva", "halva priset" eller andra liknande uttryck som används av oss endast representerar en uppskattning av besparingar du kan dra nytta av att köpa vissa verktyg hos oss jämfört med de stora toppmärkena och betyder inte nödvändigtvis att täcka alla kategorier av verktyg erbjuds av oss. Du påminns om att noggrant kontrollera när du gör en beställning hos oss om du verkligen sparar hälften i jämförelse med de främsta varumärkena.

# VEVOR®

TOUGH TOOLS, HALF PRICE

## ELEKTRONISKT TRUMSET

MODELL: MD200F-P F

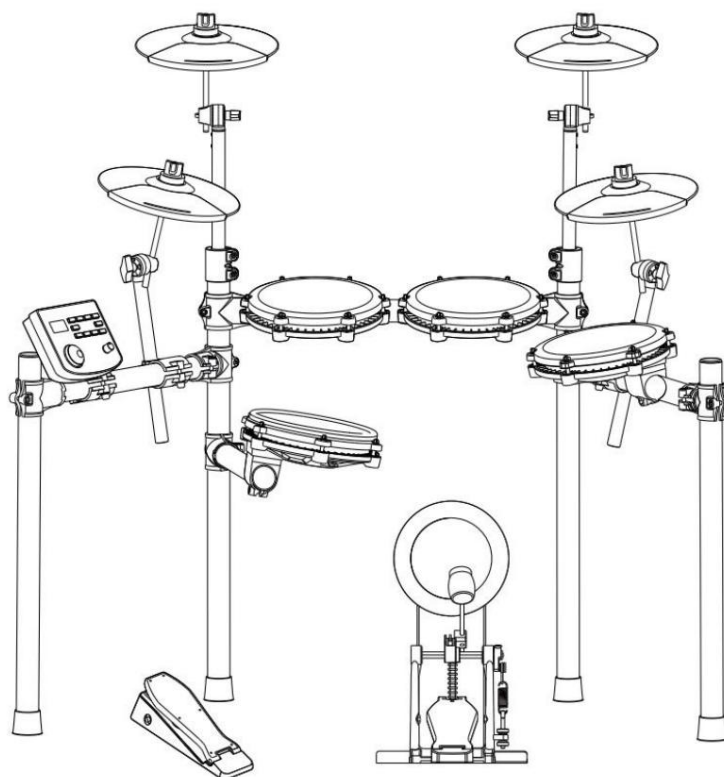

(Bilden är endast för referens, se det faktiska objektet )

### BEHÖVS HJÄLP? KONTAKTA OSS!

Har du produktfrågor? Behöver du teknisk support? Du får gärna kontakta oss:

**Teknisk support och e-garanticertifikat [www.vevor.com/support](http://www.vevor.com/support)**

Detta är den ursprungliga instruktionen, läs alla instruktioner noggrant innan du använder den. VEVOR reserverar sig för en tydlig tolkning av vår användarmanual. Utseendet på produkten är beroende av den produkt du fått. Ursäkta oss att vi inte kommer att informera dig igen om det finns någon teknik eller mjukvaruuppdateringar på vår produkt.



## FUNKTION INTRODUKTION

Tack för att du valde vår elektroniska trumma. Elegant och delikat elektronisk trumma är den perfekta kombinationen av modern ny elektronisk teknik. • Innan du använder denna produkt måste du läsa instruktionerna i detalj.

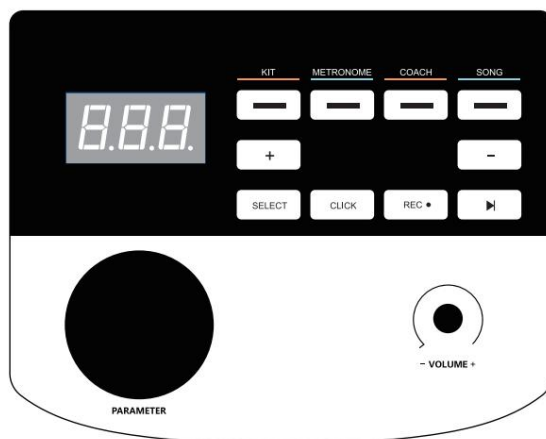

- 32 set trummor, 480 klangfärger
- 30 låtar
- Stöd justering av känslighetsparametrar för varje trumma
- Tre undervisningslägen
- Hastighetskontroll: 30 ~ 250 slag/min
- Metronom: 1-9 typer
- Andra funktioner: parameterlagring, återställning och inspelning;
- tresiffrig LED-display;
- gränssnitt: strömförsörjning dc, usbmidi, hörlurar, ljudingång, ljudutgång

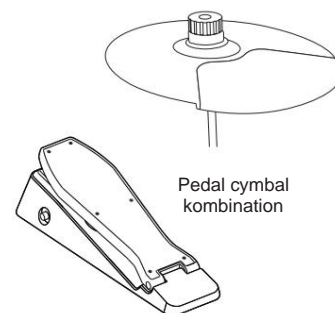
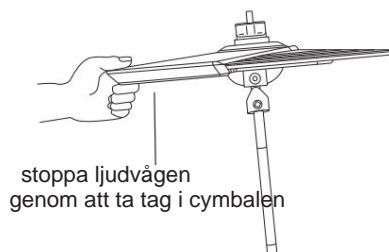
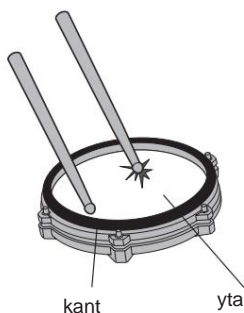

### ANMÄRKNING!

- Denna produkt är en elektroakustisk instrumentprodukt. Det är normalt att det är lite aktuellt ljud i högtalaren eller hörlurarna efter påslagning. Håll dig borta från "radio, TV, antennmottagare, router, kylskåp, TV, motor och andra elektriska RF-störningskällor" under användning.

**INNEHÅLL**

<b>FUNKTIONS INTRODUKTION</b>	<b>1</b>
<b>INNEHÅLL</b>	<b>2</b>
<b>INSTALLATIONSGUIDE</b>	<b>3</b>
KONTROLLERA BILAGADE ARTIKLAR	3
LRON RÖRHÅLLARE	4
TYMPANISK INTUBATION	4
MONTERINGSSTÄLL	5
INSTALLERA TRUMMODULEN	5
INSTALLERA SLAGDELAR OCH LJUDMODUL	6
INSTALLERA Sparktrumman	7
INSTALLERA HAMMARBÅREN	7
Sparktrumman ÄR FIXAD MED STEGHAMMEREN	7
KOPPLA I ANSLUTNINGSKABELN FÖR STRIKANDE DELEN	7
<b>ILLUSTRATION AV LJUDMODULPORT</b>	<b>8</b>
ANSLUTNING AV nätsladd	8
USB MIDI-PORT	8
LJUDUTGÅNGSPORT	8
LJUDINGÅNGSPORT	8
HÖRTELEFONPORT	8
ÖKA PORT	8
BT-LÄGE	8
<b>ANVÄNDARGUIDE</b>	<b>9</b>
KRAFT	9
VAL av trumset	9
METRONOM	9
ÖVNINGSFUNKTION	9
TRÄNSLÄGE	9
DEMO-LÅTAR	10
TRUMPARAMETRAR	10
INSPELNINGSFUNKTION	10
SPARA / ÅTERSTÄLL	10
USB MIDI	11
<b>BILAGA</b>	<b>11</b>
TIMBRE	11
FÖRINSTÄLLDA trumset	11
ANVÄNDARDEFINIERADE trumset	11
DEMONSTRATIONSÅNG	11
<b>PRODUKTUNDERHÅLL</b>	<b>12</b>
<b>SÄKERHETSÅTGÄRDER</b>	<b>13</b>



# INSTALLATIONSGUIDE

## ANMÄRKNING!

- Följ instruktionerna och läs noggrant igenom "säkerhetsföreskrifterna" i användarmanualen innan användning.
- Denna produkt måste installeras av en vuxen, låt inte den minderåriga installera den självständigt.

# 01

## Kontrollera de bifogade föremålen

- Efter att ha öppnat förpackningen, kontrollera omedelbart om den innehåller alla föremål. Om det finns några utelämnanden, kontakta din återförsäljare.



Ljudmodul



Modulfäste

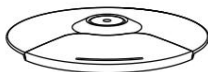

Cymbal \*4

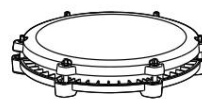

Tom (3st)



Snara



Bakre stöd



Kopplingsfäste



Framfäste



Sparka

2 st 2 st 6 st



skruva

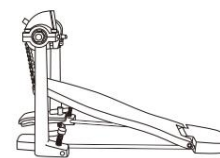

Sparkpedal



Cymbalarm  
(4st)



Hej hattpedal



Bultförare



Signalanslutningskabel

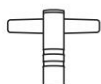

Trumnyckel



Strömadapter



Trumpinne



Stick hammare



## MONTERINGSRITNING

### 02

### järnrörshållare

•Stället ligger i en liten individuell förpackning inuti kartongen.

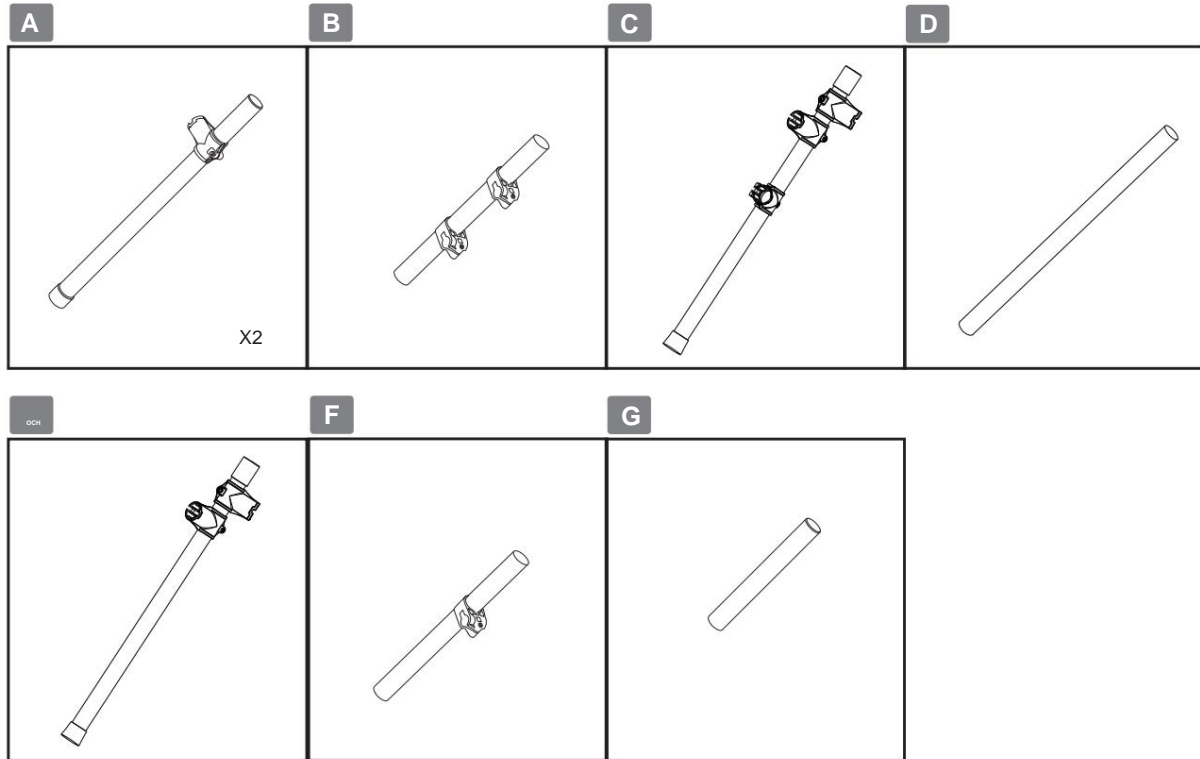

### 03 Tympanisk intubation

Installera trumman på trummans stödstång.

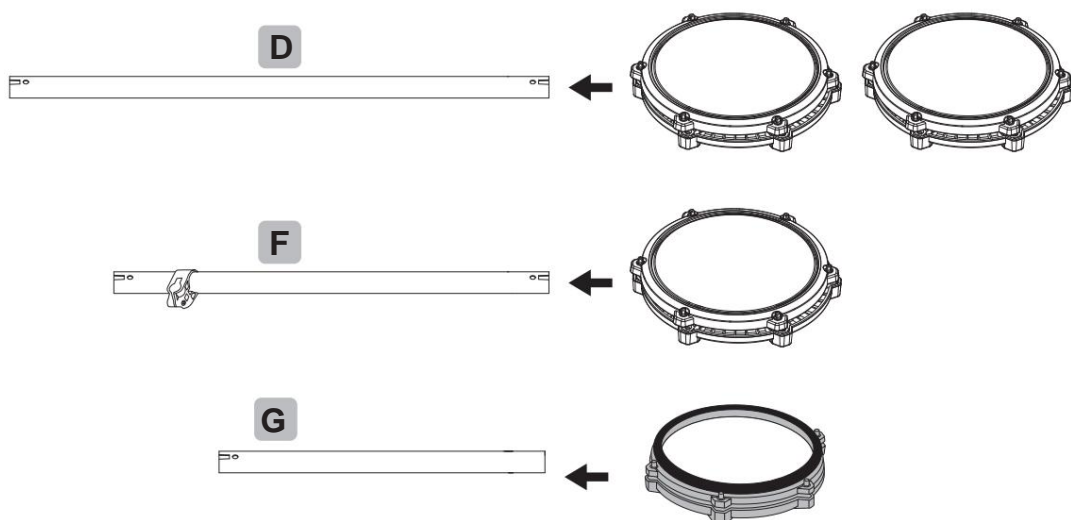



# INSTALLATIONSGUIDE

## 04

### Monteringsstativ

- Under installationen, dra åt skruvarna och var försiktig så att du klämmer fingrarna.
- Montera fästet i angiven riktning

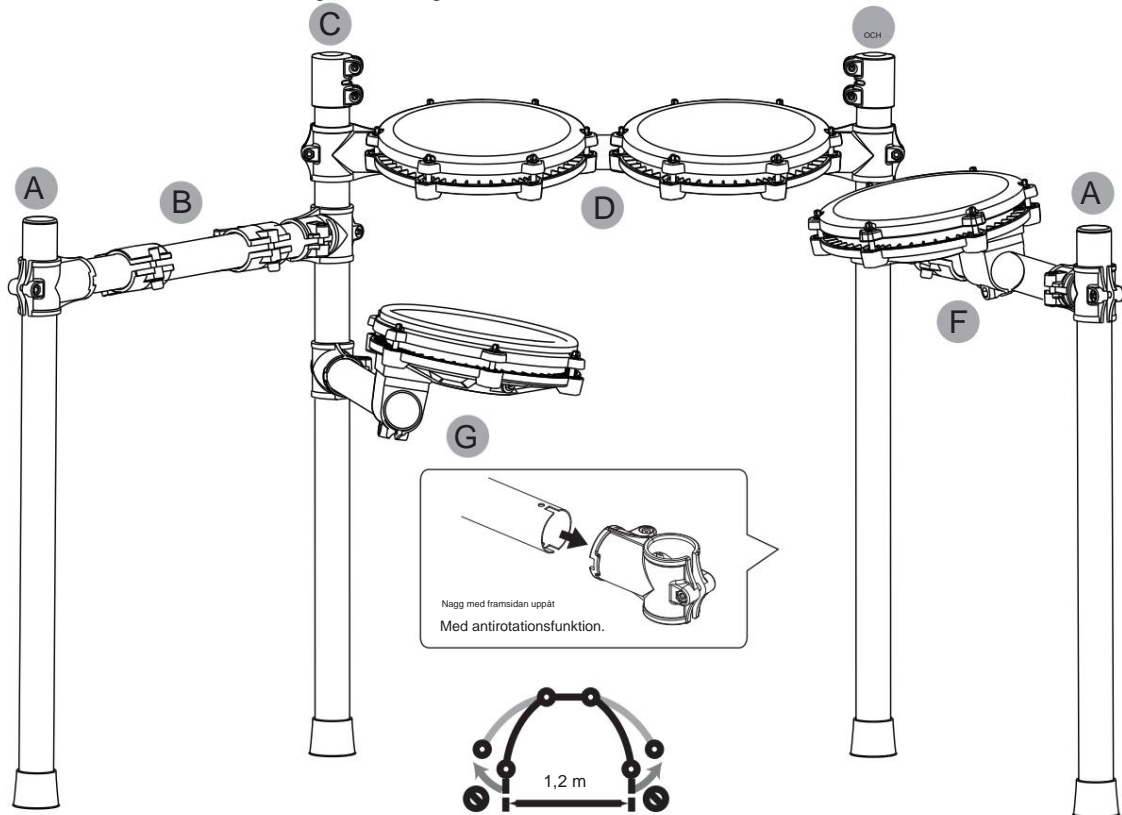

Av säkerhetsskäl bör stödets expansionsbredd inte vara större än 1,2 meter.

## 05

### Installera trummodulen

- Sätt in den på plats under montering.

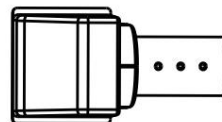
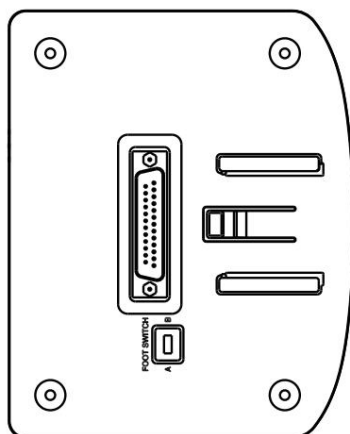

Rikta in stordatortrummodulen med stordatorlådans spår och sätt in den. När du har satt in den i botten kan du höra snäppbitarna dyker upp.



## INSTALLATIONSGUIDE

# 06

### Installera träffande delar och ljudmodul

- Dra åt skruvarna efter att trumman har satts in för att undvika att den lossnar.
- Se till att inte dra åt cymbalen för hårt, lämna lite utrymme så att de kan slingra sig upp och ner.

Dra ut muttrarna och cirkelkuddarna på de tre cymbalarmen, sätt de tre cymbalerna i motsvarande arm och skruva på muttrarna. Sätt i 3 fat respektive 1 fat i motsvarande stödstång och dra åt skruvarna.

Obs: funktionerna för varje cymbal, Tom-trumma och virveltrumma är olika, så det är nödvändigt att hänvisa till tillbehörsidentifieringen för korrekt installation!

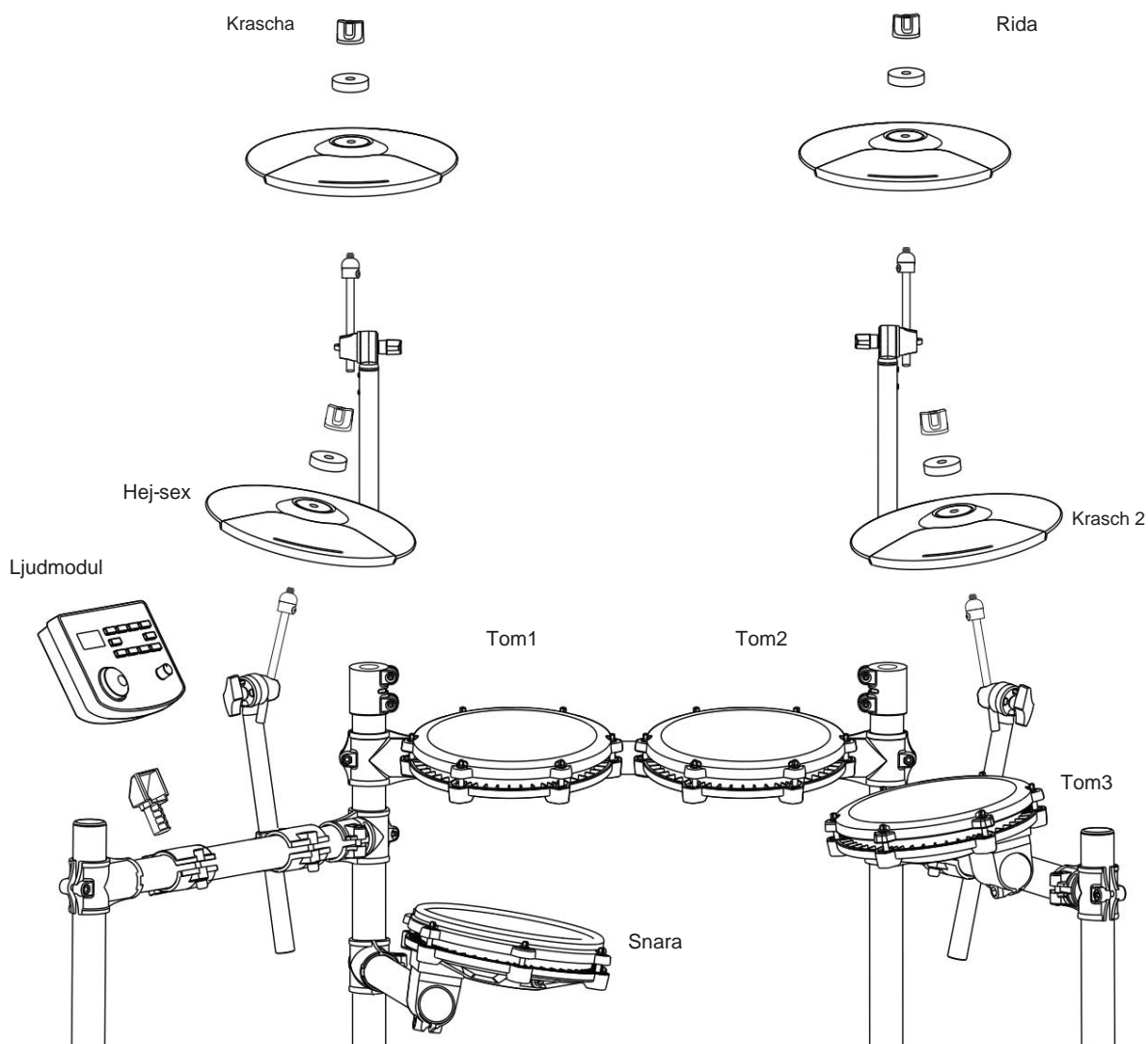



# INSTALLATIONSGUIDE

## 07

### Installera kicktrumman

- Dra åt skruvarna vid installationen och var försiktig så att du inte klämmer fingrarna.

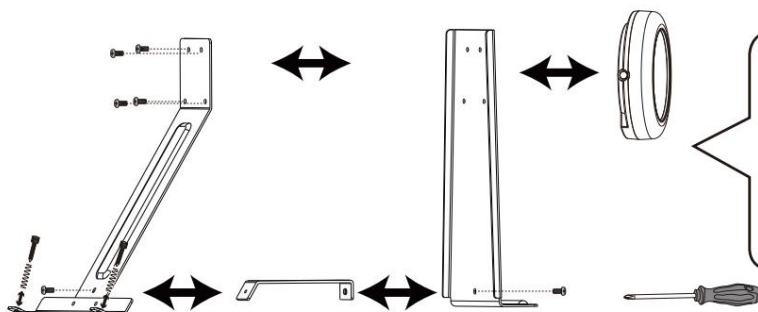

Använd en skruvmejsel för att fästa den nedre trumman, fästen enligt bilden, stöddelar med 6 små skruvar. Sätt sedan 2 fjädrar i 2 halkskyddsskruvar och lås de 2 fjädrarna i botten av stödstycket tills det vilar på marken.

## 08

### Installera hammarstången

- stången ska sättas in i spets och skruvarna ska dras åt för att undvika att de lossnar.

Sätt in hammarstången i det runda hålet som visas i figuren, rotera yllehammaren för att rikta in den mot trumytan, och dra sedan åt den med trumnyckeln.

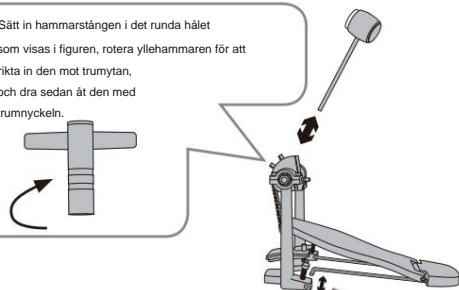

Sätt in den fasta järnstången i hålet som visas i figuren.

## 09

### Sparktrumman är fixerad med steghammaren

- bottenrumman och steghammaren ska fixeras och dras åt för att undvika att ramla av.



Sätt in den utskjutande kanten på den låga trumman i hammarfästklämma som visas i figur och dra åt skruvarna.

## 10

### Sätt i anslutningskabeln för den slående delen

- Sätt i anslutningskabeln på plats för att undvika dålig kontakt och sätt in den korrekt enligt bilden.

Kontrollera om den nedre trumman gör ljud, om det inte finns något ljud, vrid strömbrytaren:  
Omkopplare i A: mekanisk sparktrumma  
Omkopplare i B: pedalläge.

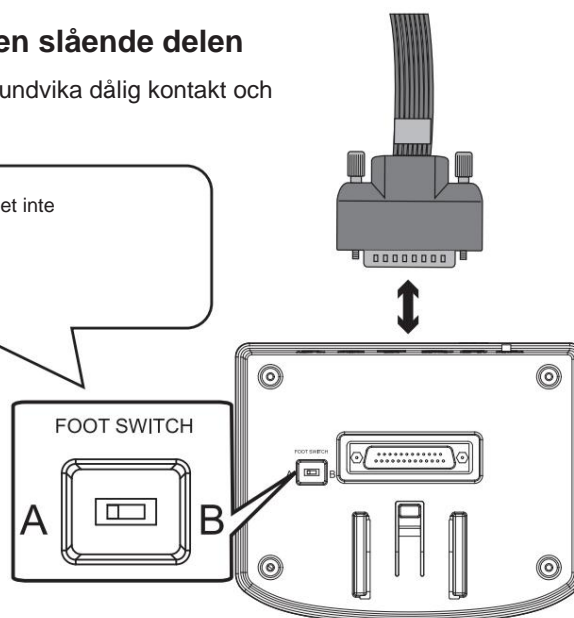



## ILLUSTRATION AV LJUDMODULPORT

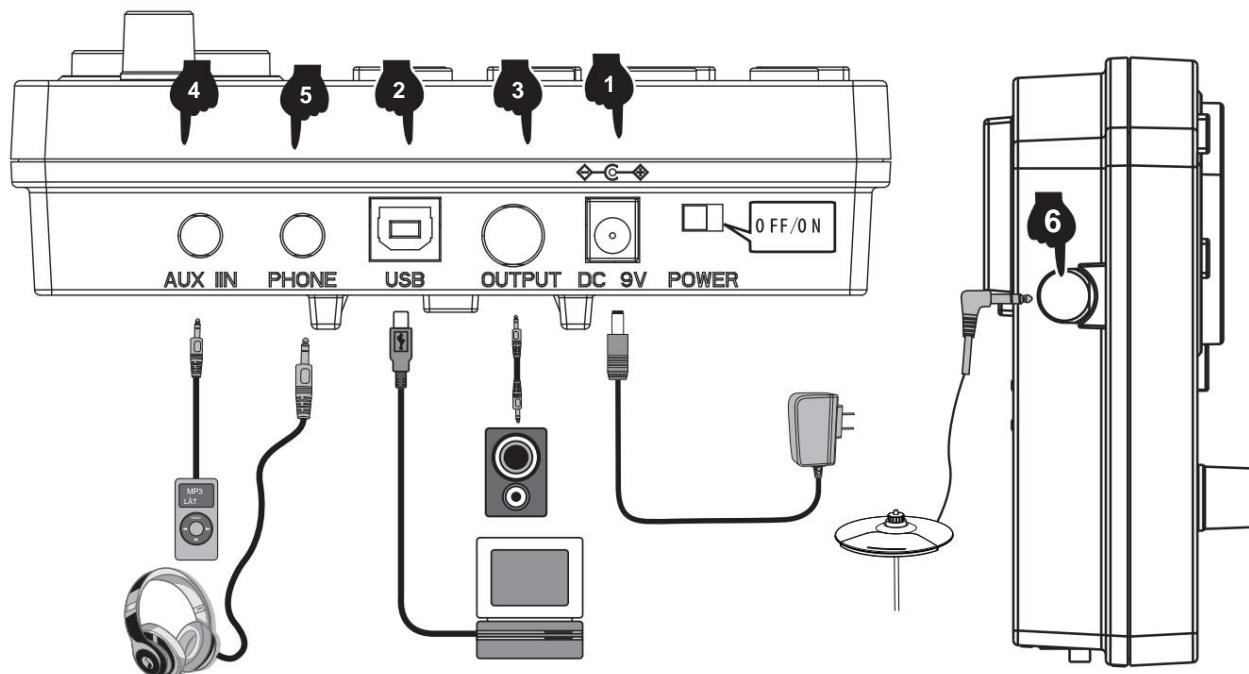

### 1 ANSLUTNING AV NÄTSLAD

1. Vid användning, anslut strömterminalen enligt diagrammet, sätt i ljudmodulens eluttag i ena änden och 100-240V hushållsuttag i andra änden. (Figur 1)
2. Om du inte använder den här produkten under en längre tid, vänligen dra ut strömkontakten och förvara den på rätt sätt.

### 2 USB MIDI-PORTAR

Användningen av elektronisk trumma MIDI USB-gränssnitt kan interagera med musikenheter med MIDI.

1. Genom den förinstallerade programvaran Musik på datorer och mobiltelefoner kan vi lära oss att spela, komponera musik, butik och andra funktioner. (Fig. 2)
2. När den är ansluten till en dator eller mobiltelefon måste enhetens ljudutgång anslutas till ljudingången på modulboxen för att synkronisera ljudeffekterna på enheten. (Fig. 5)

### 3 LJUDUTGÅNGSPORT

Ljudutgång kan anslutas till aktiv högtalare (särskild elektronisk trumhögtalare) och stor ljudutrustning. (Fig. 3)

### 4 AUDIO INPUT PORT

Ljudingångsporten kan ansluta ljudkällans uppspelningsenhet till modulboxen för uppspelning (som MP3, mobiltelefon och annan ljudsignal). (Fig. 4)

### 5 HÖRTELEFONPORT

Anslutande hörlurar övervakar detaljerna i slagverk och stör inte andra när de spelar utan anslutning högtalare. (Fig. 5)

### 6 ÖKA PORT

Denna port låter dig lägga till en cymbal för enkel expansion. (Figur 6)



## ANVÄNDARGUIDE

### 1 STRÖM

Sätt i DC-kontakten i DC 9V-porten på ovansidan av styrenheten. Skjut POWER-omkopplaren åt höger (sett från framsidan) för att slå på trumsetet. För att stänga av trumsetet, skjut omkopplaren åt vänster.

### 2 VAL AV trumset

Tryck på KIT-knappen för att visa det aktuella trumsetet. Vrid på parameterhjulet eller använd <- />-knapparna för att välja önskad trumset. Det finns 32 trumset att välja mellan - se trumsetlistan på sidan 11.

### 3 METRONOM

1. Tryck på METRONOME-knappen för att gå in i metronomläget.
2. Skärmen visar hastighetsvärdet (120 BPM standardhastighet). Vrid parameterhjulet eller använd +/- knapparna för att ändra metronomhastigheten. Tryck på CLICK-knappen för att starta metronomen.
3. Tryck på SELECT-knappen i metronomläge, så hoppar skärmen till metronomens parameterjustering  
Du kan trycka på +/- knapparna för att välja den parameter du vill justera:  
A. ryslagtyp: 2,4,8,16y  
B. b (slagnummer: 01-09)  
C. L(metronomvolym: 00 (av) -31), och vrid sedan på parameterhjulet för att justera parameterinställningarna.
4. När parametrarna har justerats, tryck på SELECT-knappen för att bekräfta och avsluta parametergränssnittet.  
använd CLICK-knappen för att starta och stoppa metronomen enligt önskemål.

### 4 ÖVNINGSFUNKTION

"Coach"-tränarläget för denna produkt kan hjälpa till att etablera snabbhet, noggrannhet och uthållighet, och hjälpa till att odla övningsfunktionen för en bättre känsla för rytm. Gör framsteg under överinseende av tränarläget "coach"!

Tryck på "coach"-knappen för att gå in i coachläget. I detta läge finns det tre övningslägen. Välj praktiken läge via datahjulet eller knappen < + > < - >.

1. Träningsläge 1: C-1 taktdekteteringsövning: slå på trumman med en fast hastighet för att träna slagets noggrannhet.
2. Övningsläge 2: C-2 tyst slagläge: metronomen låter en sektion och tystar en sektion för att träna slagnoggrannhet utan metronomprompt. Det är en avancerad version av övningsläge 1.
3. Övningsläge 3: C-3 speed strike övning, metronomen kommer automatiskt att ändra hastigheten, öka från den långsammaste till den snabbaste, och sedan minska från den långsammaste till den långsammaste hastigheten, så som att träna strejkuthålligheten.

### 5 COACH-LÄGE

1. Träningsläget "coach" för denna produkt kan hjälpa till att fastställa hastighet, noggrannhet och uthållighet. Tryck på COACH knappen för att gå in i tränarläget. I detta läge finns det tre övningslägen. Använd parameterhjulet för att välja vilket övningsläge.  
A. Träningsläge 1:C-1 taktdekteteringsövning - slå på trumman med en fast hastighet för att träna slagets noggrannhet.  
B. Övningsläge 2:C-2 tyst slagläge - metronomen låter en sektion och tystar en sektion för att träna när det inte finns något slag.  
C. Övningsläge 3:C-3 speed strike övning - metronomen kommer automatiskt att ändra hastigheten från den långsammaste till den snabbaste och sedan den snabbaste till den långsammaste.
2. När coachningsläget har valts, tryck på KLICK-knappen. Metronomslagen börjar och du kan spela med på trumman för att träna.
3. Efter fyra preliminära slag visar displayen:

(för långsam)



(Bra)



(för snabbt)





## ANVÄNDARGUIDE

4. När du har slutfört coachningsläget kommer ett resultat att visas från 0-100 som utvärderar noggrannheten av övningen.

C-1-läge: Tryck på SELECT-knappen för att gå in i parameterinställningsgränssnittet. Du kan anpassa antalet övningar sessioner efter behov (01-32). Antalet träningspass avgör längden på denna övning.

C-2-läge: Tryck på SELECT-knappen för att gå in i parameterinställningsgränssnittet. Du kan justera antalet träningspass efter behov (04-32). Antalet träningspass avgör längden på denna övning.

C-3-läge: Tryck på SELECT-knappen för att gå in i parameterinställningsgränssnittet. Du kan justera hastigheten med vilken BPM ändringar (01-09 BPM).

5. Tryck på CLICK-knappen igen för att avsluta coachläget.

### 6 DEMO-LÅTAR

1. Tryck på SONG-knappen för att gå in i demoläget, det finns 30 demos att välja mellan. Skärmen visar strömmen demolåtnummer (01 -30).
2. Tryck på <>-knappen för att börja spela demolåtarna. För att stoppa uppspelningen, tryck på <>-knappen igen.
3. Vrid på parameterhjulet eller tryck på +/- knapparna för att välja en demosong.
4. Tryck på SELECT-knappen i sångläge för att hoppa till sångparameterinställningsgränssnittet. Du kan slå på trumljudet eller av genom att vrida på parameterhjulet (trumljudet är på som standard).
5. Tryck på SELECT-knappen för att bekräfta och avsluta parametergränssnittet.

### 7 TRUMPARAMETRAR

1. Tryck på KIT-knappen och skärmen visar 01 (trumsetnummer). Tryck på SELECT för att ange trumparametern justeringsläge.
2. Tryck på trumman du vill justera och tryck sedan på +/- knapparna för att välja parametern för justering. Känslighet
 

A. S(01-06). Triggertröskel t(01 - 32).	Överhörningströskel c (01 -32)
B. Upprepad avtryckare r(01-32) Trumkraft	V(01-03). Trumvolym L (00 - 31).
3. Ändra parametrarna genom att vrida på parameterhjulet och trycka länge på --knappen för att spara. Skärmen med display SAV för att indikera att parameterjusteringen har sparats.
4. För att återställa trumparametrarna till fabriksinställningarna, tryck länge på ++knappen tills skärmen visar RES.
5. OBS: Parametrarna för 3 tom-trummor kan inte ställas in individuellt.

### 8 INSPELNINGSFUNKTION

1. Tryck på knappen < REC > när indikatorlampan är i lägena "KIT" och "CLICK", och skärmen visar orden "REC" i andningsblinkande tillstånd, går in i inspelningsförberedelseläge.
2. Tryck på valfri trumma och metronomen låter. Vid denna tidpunkt visar skärmen "---" i det blinkande andningsläget och börjar spela in.
3. Tryck på knappen < REC > eller < PLAY > igen, inspelningen stoppas och "A-1" visas på skärmen.
4. Tryck på < ▶ > för att börja spela den aktuella inspelningen och tryck igen för att stoppa uppspelningen.
5. Om du går in i inspelningsförberedelseläget igen utan att knacka, spelas "A-1" som spelades in senast.

### 9 SPARA / ÅTERSTÄLL

1. För att spara parametrar, tryck länge på <->-knappen och skärmen kommer att visa SAV.
2. För att återställa parametrar, tryck länge på <+>-knappen och skärmen visar RES res.

### 10 USB MIDI

För att använda trumsetens MID-funktion ansluter du aUSB-B-datakabeln (medföljer inte detta trumset) i kontrollenheten och anslut till PC/ smartphone.



## Klangfärg

<b>Sparka .</b>	70 . Rock Snare Rim	134 . Rock Tom2	198 . Rock Crash1	262 . Rock Ride	326 . Rock Hi-Hat Open 327 .
	71 . Metall Snare Rim	135 . Metal Tom2	199 . Metal Crash1	263 . Metal Ride	Metal Hi-Hat Open 328 .
1 . Pop Kick 2 .	72 . PowerMetal Snare Rim	136 . PowerMetal Tom2	200 . PowerMetal Crash1	264 . PowerMetal Ride	PowerMetal Hi-Hat Open 329 .
Fuck Kick	73 . SpeedMetal Snare Rim	137 . SpeedMetal Tom2 138 .	201 . SpeedMetal Crash1 202 .	265 . SpeedMetal Ride	SpeedMetal Hi-Hat Open 330 .
3 . Hård spark	74 . PopJazz Snare Rim	PopJazz Tom2	PopJazz Crash1 203 .	266 . PopJazz Ride	PopJazz Hi-Hat Open 331 .
4 . Original Kick	75 . Jazz Snare Rim	139 . Jazz Tom2	Jazzkrasch1	267 . Jazzritt	Jazz Hi-Hat Open
5 . PopRock Kick	76 . 808	140 . 808	204 . 808	268 . 808	332 . 808
6 . Rock Kick	77 . 909	141 . 909	205 . 909	269 . 909	333 . 909
7 . Metal Kick	78 . Songo Snare Rim	142 . Songo Tom2	206 . Songo Crash1	270 . Songo skrattar	334 . Songo Hi-Hat Open
8 . PowerMetal Kick	79 . Standard Snare Rim	143 . Standard Tom2	207 . Standardkrasch1	271 . Standardritt	335 . Standard Hi-Hat Open
9 . SpeedMetal Kick 10 .	80 . Akustisk Snare Rim	144 . Akustisk Tom2	208 . Akustisk krasch1	272 . Akustisk åktur	336 . Acoustic Hi-Hat Open
PopJazz Kick 11 .	81 . Seesion Snare Rim	145 . Seesion Tom2	209 . Seesion Crash1	273 . Seesion Ride	337 . Seesion Hi-Hat Open
Jazz Kick	82 . Modern Snare Rim	146 . Modern Tom2	210 . Modern Crash1	274 . Modern Ride	338 . Modern Hi-Hat Open
12 . 808	83 . Blues Snare Rim	147 . Blues Tom2	211 . Blues Crash1	275 . Blues Ride	339 . Blues Hi-Hat Open
13 . 909	84 . Klassisk Snare Rim	148 . Klassisk Tom2	212 . Klassisk krasch1	276 . Classic Ride	340 . Classic Hi-Hat Open
14 . Songo Kick	85 . Synthgaze Snare Rim	149 . Synthgaze Tom2	213 . Synthgaze Crash1 214 .	277 . Synthgaze Ride	341 . Synthgaze Hi-Hat Open 342 .
15 . Standard Kick	86 . Freak Snare Rim	150 . Freak Tom2	Freak Crash1	278 . Freak Ride	Freak Hi-Hat Open 343 .
16 . Akustisk kick	87 . Sticks Snare Rim	151 . Sticks Tom2	215 . Sticks Crash1	279 . Sticks Ride	Sticks Hi-Hat Open 344 .
17 . Seesion Kick	88 . Grunge Snare Rim	152 . Grunge Tom2	216 . Grunge Crash1	280 . Grungeritt	Grunge Hi-Hat Open 345 . 70-
18 . Modern kick	89 . Snare Rim från 70-talet	153 . 70-talet Tom2	217 . 70-talskrasch1	281 . 70-talsritt	talets Hi-Hat Open 346 .
19 . Blues Kick	90 . Snare Rim från 80-talet	154 . 80-talet Tom2	218 . 80-talskrasch1	282 . 80-talsritt	80-talets Hi-Hat Open
20 . Klassisk kick	91 . Populära Snare Rim	155 . Populära Tom2	219 . Populär Crash1	283 . Populär åktur	347 . Populära Hi-Hat Open
21 . Synthgaze Kick	92 . Slam Snare Rim	156 . Slam Tom2	220 . Slam Crash1	284 . Slam Ride	348 . Slam Hi-Hat Open
22 . Freak Kick	93 . Attackerera Snare Rim	157 . Attackerera Tom2	221 . Attackkrasch1	285 . Attacktur	349 . Attack Hi-Hat Open
23 . Sticks Kick	94 . Gamla Snare Rim	158 . Gamla Tom2	222 . Gammal krasch1	286 . Old Ride	350 . Old Hi-Hat Open
24 . Grunge Kick	95 . Fairfax Snare Rim	159 . Fairfax Tom2	223 . Fairfax Crash1	287 . Fairfax Ride	351 . Fairfax Hi-Hat Open
25 . 70-tals Kick	96 . Militär Snare Rim	160 . Militär Tom2 161 .	224 . Militär krasch1	288 . Militär åktur	352 . Military Hi-Hat Open
26 . 80-tals Kick	<b>Tom .</b>	Pop Tom3	225 . Pop Crash1 Rim 226 .	289 . Pop Ride Rim	353 . Pop Hi-Hat Close
27 . Populär Kick		162 . Fan Tom3	Fuck Crash1 Rim	290 . Fuck Ride Rim	354 . Fuck Hi-Hat Close
28 . Slam Kick		163 . Hård Tom3	227 . Hård Crash1 fölg	291 . Hard Ride Rim	355 . Hård Hi-Hat Close
29 . Attack Kick		164 . Original Tom3	228 . Original Crash1 Rim 229 .	292 . Original Ride Rim	356 . Original Hi-Hat Close
30 . Gammal Kick		165 . PopRock Tom3	PopRock Crash1 fölg 230 . Rock	293 . PopRock Ride Rhytm	357 . PopRock Hi-Hat Stäng
31 . Fairfax Kick		166 . Rock Tom3	Crash1 fölg	294 . Rock Ride Rim	358 . Rock Hi-Hat Close
32 . Militär spark		167 . Metal Tom3	231 . Metal Crash1 fölg	295 . Metal Ride Rim	359 . Metall Hi-Hat Stäng
		168 . PowerMetal Tom3	232 . PowerMetal Crash1 fölg	296 . PowerMetal Ride Rim	360 . PowerMetal Hi-Hat Stäng
		169 . SpeedMetal Tom3 170 .	233 . SpeedMetal Crash1 Fölg 234 .	297 . SpeedMetal Ride Rim	361 . SpeedMetal Hi-Hat Close 362 .
		PopJazz Tom3	PopJazz Crash1 Rim 235 . Jazz	298 . PopJazz Ride Rim	PopJazz Hi-Hat Stäng
		171 . Jazz Tom3	Crash1 Rim	299 . Jazz Ride Rim	363 . Jazz Hi-Hat Close
		172 . 808	236 . 808	300 . 808	364 . 808
		173 . 909	237 . 909	301 . 909	365 . 909
		174 . Songo Tom3	238 . Songo Crash1 fölg 239 .	302 . Songo Ride Rim	366 . Songo Hi-Hat Close
		175 . Standard Tom3	Standard Crash1-fölg	303 . Standard Ride Rim	367 . Standard Hi-Hat Stäng
		176 . Akustisk Tom3	240 . Acoustic Crash1 fölg	304 . Akustisk Ride Rim	368 . Akustisk Hi-Hat Close
		177 . Seesion Tom3	241 . Seesion Crash1 fölg	305 . Seesion Ride Rim	369 . Seesion Hi-Hat Close
		178 . Modern Tom3	242 . Modern Crash1 fölg	306 . Modern Ride Rim	370 . Modern Hi-Hat Close
		179 . Blues Tom3	243 . Blues Crash1 Rim	307 . Blues Ride Rim	371 . Blues Hi-Hat Stäng
		180 . Klassisk Tom3	244 . Klassisk Crash1 fölg	308 . Classic Ride Rim	372 . Klassisk Hi-Hat Close
		181 . Synthgaze Tom3	245 . Synthgaze Crash1 Rim 246 .	309 . Synthgaze Ride Rim	373 . Synthgaze Hi-Hat Close
		182 . Freak Tom3	Freak Crash1 fölg	310 . Freak Ride Rim	374 . Freak Hi-Hat Close
		183 . Sticks Tom3	247 . Sticks Crash1 Rim	311 . Sticks Ride Rim	375 . Sticks Hi-Hat nära
		184 . Grunge Tom3	248 . Grunge Crash1 Rim 249 .	312 . Grunge Ride Rim	376 . Grunge Hi-Hat Stäng
		185 . 70-talets Tom3	70-tal Crash1 Rim	313 . 70-tals Ride Rim	377 . 70-tals Hi-Hat Close
		186 . 80-talet Tom3	250 . Crash1 Rim från 80-talet	314 . Ride Rim från 80-talet	378 . 80-tals Hi-Hat Close
		187 . Populära Tom3	251 . Populära Crash1 Rim	315 . Populär Ride Rim	379 . Populära Hi-Hat Close
		188 . Slam Tom3	252 . Slam Crash1 fölg	316 . Slam Ride Rim	380 . Slam Hi-Hat Close
		189 . Attackerera Tom3	253 . Attack Crash1 Rim	317 . Attack Ride Rim	381 . Attackerera Hi-Hat Close
		190 . Gamla Tom3	254 . Gammal Crash1-fölg	318 . Old Ride Rim	382 . Gammal Hi-Hat nära
		191 . Fairfax Tom3	255 . Fairfax Crash1 fölg	319 . Fairfax Ride Rim	383 . Fairfax Hi-Hat Stäng
		192 . Militär Tom3	256 . Military Crash1 Rim	320 . Military Ride Rim	384 . Militär Hi-Hat Close 385 .
		<b>Krasch .</b>	<b>Rida .</b>	<b>Hi-Hat.</b>	Pop Hi-Hat Pedal
		193 . Popkrasch1	257 . Pop Ride	321 . Pop Hi-Hat Open	386 . Fuck Hi-Hat Pedal
		194 . Fuck Crash1	258 . Fuck Ride	322 . Fuck Hi-Hat Open	387 . Hård Hi-Hat-pedal
		195 . Hård krasch1	259 . Hard Ride	323 . Hard Hi-Hat Open	388 . Original Hi-Hat Pedal
		196 . Original Crash1	260 . Original Ride	324 . Original Hi-Hat Open	389 . PopRock Hi-Hat Pedal
		197 . PopRock Crash1	261 . Pop Rock Ride	325 . PopRock Hi-Hat Open	390 . Rock Hi-Hat Pedal
					391 . Metall Hi-Hat Pedal
					392 . PowerMetal Hi-Hat Pedal
					393 . SpeedMetal Hi-Hat Pedal 394 .
					PopJazz Hi-Hat Pedal
					395 . Jazz Hi-Hat Pedal
					396 . 808
					397 . 909
					398 . Songo Hi-Hat Pedal
					399 . Standard Hi-Hat Pedal



## APPENDIX

400 . Akustisk Hi-Hat-pedal		433 . Sesion Crash2	450 . Fuck Crash2 Rim	467 . Blues Crash2 Rim
401 . Seesion Hi-Hat Pedal		434 . Modern Crash2	451 . Hård Crash2 föl	468 . Klassisk Crash2 föl
402 . Modern hi-hatpedal	417 . Popkrasch 2	435 . Blues Crash2	452 . Original Crash2 föl	469 . Synthgaze Crash2 Rim
403 . Blues Hi-Hat Pedal	418 . Fuck Crash2	436 . Klassisk Crash2	453 . PopRock Crash2 Rhyme	470 . Freak Crash2 föl
404 . Klassisk Hi-Hat Pedal	419 . Hård krasch 2	437 . Synthgaze Crash2	454 . Rock Crash2 föl	471 . Sticks Crash2 Rim
405 . Synthgaze Hi-Hat Pedal	420 . Original Crash2	438 . Freak Crash2	455 . Metal Crash2 föl	472 . Grunge Crash2 Rim
406 . Freak Hi-Hat Pedal	421 . PopRock Crash2	439 . Sticks Crash2	456 . PowerMetal Crash2 föl	473 . 70-tals Crash2 Rim
407 . Sticks Hi-Hat Pedal	422 . Rock Crash2	440 . Grungekrasch 2	457 . SpeedMetal Crash2 föl	474 . Crash2 Rim från 80-talet
408 . Grunge Hi-Hat Pedal	423 . Metal Crash2	441 . 70-talskrasch2	458 . PopJazz Crash2 Rim	475 . Populära Crash2 Rim
409 . 70-tals Hi-Hat Pedal	424 . PowerMetal Crash2	442 . 80-talskrasch2	459 . Jazz Crash2 föl	476 . Slam Crash2 föl
410 . 80-tals Hi-Hat Pedal	425 . SpeedMetal Crash2	443 . Populär Crash2	460 . 808	477 . Attack Crash2 Rim
411 . Populär Hi-Hat Pedal 412.	426 . PopJazz Crash2	444 . Slam Crash2	461 . 909	478 . Gammal Crash2-föl
Slam Hi-Hat Pedal 413.	427 . Jazzkrasch 2	445 . Attack Crash2	462 . Songo Crash2 Rim	479 . Fairfax Crash2 Föl
Attack Hi-Hat Pedal 414 .	428 . 808	446 . Gammal Crash2	463 . Standard Crash2-föl	480 . Military Crash2 Rim
Gammal Hi-Hat Pedal	429 . 909	447 . Fairfax Crash2 föl	464 . Acoustic Crash2 föl	
415 . Fairfax Hi-Hat Pedal	430 . Songo Crash2	448 . Militär krasch 2	465 . Seesion Crash2 föl	
416 . Militär Hi-Hat-pedal	431 . Standard Crash2	449 . Pop Crash2 Rim	466 . Modern Crash2-föl	
	432 . Akustisk krasch 2			

Krasch 2

### Drum combination timbre

01 Pop	09 SpeedMetal
02 Fan	10 PopJazz
03 Svårt	11 Jazz
04 Original	12 808
05 Poprock	13 909
06 Rock	14 Songo
07 Metall	15 Standard
08 PowerMetal	16 Akustisk

### User drum group

17 Sesion	25 70-talet
18 Modern	26 80-talet
19 Blues	27 Populär
20 Klassisk	28 Slam
21 Synthgaze	29 Attack
22 Freak	30 gammal
23 pinnar	31 Fairfax
24 Grunge	32 Militär

### Demonstration music

Låten 001	Låt 007	Låt 013	Låt 019	Sång 025
Låten 002	Låt 008	Låt 014	Låt 020	Sång 026
Låten 003	Låt 009	Låt 015	Sång 021	Sång 027
Låt 004	Låten 010	Låt 016	Sång 022	Sång 028
Låt 005	Låten 011	Låt 017	Sång 023	Sång 029
Låt 006	Låten 012	Låt 018	Sång 024	Sång 030



## PRODUKTUNDERHÅLL

Noggrant underhåll och skydd av denna produkt spelar en mycket viktig roll för att förlänga produktens livslängd och minska fel.

### 1 Undvik värme, fukt eller direkt solljus

Överexponera inte produkten för direkt solljus, och placera den inte nära luftkonditioneringen eller extremt varm plats.

### 2 Använd inte i närheten av TV eller radio

Denna produkt kan orsaka video- eller ljudstörningar på mottagningen av TV och radio. Om detta händer, ta bort produkten från TV:n eller radion.



## PRODUKTUNDERHÅLL

### 3 Använd inte färg, thinner eller liknande kemikalier för rengöri

Använd en mjuk och smutsfri rengöringsduk doppad i en liten mängd vatten eller speciellt rengöringsmedel för att rengöra ytläckarna på denna produkt.

### 4 Skaka inte för att undvika kollision

Produkten ska hanteras med försiktighet vid förflyttning. Våldsamma vibrationer och kollision är strängt förbjudna för att undvika skador på skalet eller interna elektroniska komponenter.



## SAFETY PRECAUTIONS

### POWER SUPPLY

This product can be powered by standard indoor wall sockets. Please only use the power cord specified in this product. When not in use, please turn off the power supply. When not in use for a long time, pull out the power cord and keep it properly.

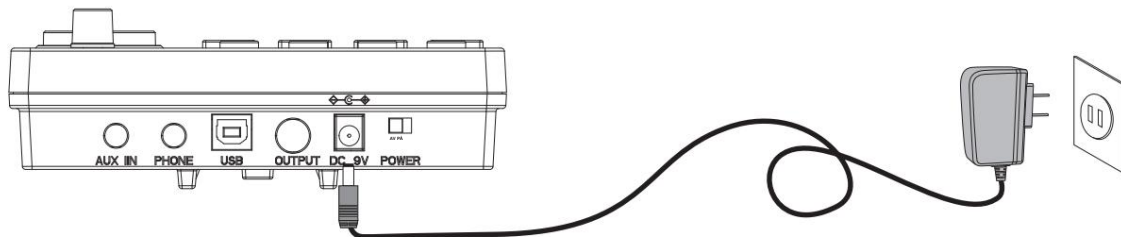

### SIGN

To ensure that you use this product safely and correctly, to prevent harm to users and others and financial damage, this manual and products are marked with a series of safety signs. The various signs and their meanings are as follows:

#### **WARNING**

This sign indicates that there is a potential risk of death or serious injury if this mark is ignored and the product is mishandled.

#### **BE CAREFUL**

This sign indicates that there is a potential danger of injury to personnel or other financial damage if this sign is ignored and the product is operated incorrectly.

### EXAMPLE OF LOGO



This triangle sign ( $\Delta$ ) indicates what users should pay attention to. (The left example is careful shocks)



A circular sign ( $\ominus$ ) with an oblique line indicates prohibitions. The icons in or beside the logo indicate the contents specifically prohibited. (The example on the left is no disassembly)



The round black bottom sign ( $\oplus$ ) indicates what must be observed. The diagrams in this sign indicate the contents of the specific matters that must be observed. (The example on the left is that the power plug must be pulled out of the socket)



## SAFETY PRECAUTIONS

### **WARNING**

#### **Smoke, odor, overheating**

When the product smokes, smells or overheats, there is a danger of fire and electric shock when it is used continually. In case of the above situation, the following operations should be performed immediately:

1. Turn off the power supply.
2. Pull the plug out of the power outlet.
3. Contact your dealer.

#### **Power cord**

1. The improper use of power cord may cause fire and electric shock. The following precautions must be observed:
  - The special power cord designated for this product must be used.
  - The AC power supply with output voltage within the rated voltage range for household use must be used.
  - Do not overload power sockets and extension lines.
2. The improper treatment of power line will lead to its damage or breakage, which will cause fire and electric shock hazards. The following precautions must be observed:
  - Do not place or heat heavy objects on power lines.
  - Do not attempt to alter or bend the power cord too much.
  - Do not twist or pull the power cord.
  - If the power cord or plug is damaged, please replace the same type of power cord.
3. Do not touch the power cord and plug with wet hands, otherwise there is a danger of electric shock.
4. Please use the power cord where the water will not splash. Water is in danger of causing fire and electric shock.
5. Never place vases or any other container containing water on this product. Water is dangerous of causing fire and electric shock.
6. Do not allow minors to unplug and touch power lines or connection boards. Minors have no common sense of electricity safety, which may cause electric shock.

### **BE CAREFUL**

The improper use of power cord may cause fire and electric shock. The following precautions must be observed:

- Never put the power cord near the oven or other heat source.
- Do not pull the cable when pulling out of the power socket. The main body of the plug must be grasped.
- The power cord plug must be inserted in the socket to the end.
- Make sure the power supply is off before connecting or disconnecting it.
- When thunderstorms occur or before traveling or other long-term departure, disconnect the power cord from the wall outlet.
- At least once a year, remove the power cord from the wall outlet and clean the dust accumulated around the plug.

#### **Do not burn this product**

Do not put this product in the fire, otherwise it will lead to product combustion and explosion of internal electronic components, which will cause fire and personnel injury.

#### **Water and foreign bodies**

Water, other liquids and (metal sheets, etc.) entering this product are in danger of causing fire and electric shock. In case of the above situation, the following operations shall be performed immediately:

1. Turn off the power supply.
2. If you are using a power cord for power supply, unplug it from the wall outlet.
3. Contact your distributor.

#### **Disassembly and transformation**

Do not disassemble or transform the product in any way, otherwise there is a risk of electric shock, scald or other personal injury. All internal inspection, adjustment and maintenance operations should be entrusted to your distributor.



## SAFETY PRECAUTIONS

### Falling or colliding

If the product falls or is damaged by strong impact, it will be in danger of causing fire and electric shock. In case of the above situation, the following operations shall be performed immediately:

1. Turn off the power supply.
2. If you are using a power cord for power supply, you need to unplug it from the wall outlet.
3. Contact your distributor.



### Plastic bag

Do not let anyone put plastic bags for this product on his head or in his mouth. Otherwise, there is a risk of asphyxia. Families with young children should pay special attention to it.



### Keep a distance from the product and the bracket

Climbing the bracket is dangerous of overturning or damage. Families with young children should pay special attention to it.



### Put

Avoid placing the product on an uneven surface or any other unstable place. Otherwise, it will cause the product to fall down, which will lead to the risk of injury.



### Product Mobility

Before moving this product, you must unplug the power cord plug from the wall outlet and pull out all other cables and connecting wires. Otherwise, it will lead to damage of power or connection wires, resulting in fire and electric shock.



### clean

Before cleaning this product, you must unplug the power cord plug from the wall outlet, otherwise there is a risk of fire and electric shock.



### Jack

The socket of this product can only be connected to the designated equipment and devices. Connecting non-designated equipment or devices is dangerous of causing fire and electric shock.



### Location selection

It should be avoided to place the product in the following places, otherwise there is a risk of fire and electric shock.



- High temperature or dusty places.
- Kitchen or other places with lampblack.
- Where the product is exposed to direct sunlight, or any other place where the product will produce high temperature.

### Volume

Don't play music long and loud. Pay special attention when using headphones. Excessive volume can damage your hearing.



### Heavy



Do not place heavy objects on this product. Otherwise, the top of the product will be overweight, causing the product to overturn or drop objects on it, which will lead to the risk of injury.



### Correct assembly of scaffolds

The incorrect assembly of the bracket may overturn, causing the product to fall off and posing a risk of injury to personnel. Therefore, it must be assembled according to the instructions in the attached installation guide to ensure that the product is properly mounted on its bracket.



	<p>Varning - För att minska risken för skada måste användaren läsa instruktionerna noggrant.</p>
	<p>Denna enhet uppfyller del 15 av FCC-reglerna. Driften är föremål för följande två villkor: (1) Den här enheten får inte orsaka skadliga störningar och (2) den här enheten måste acceptera alla mottagna störningar, inklusive störningar som kan orsaka oönskad funktion.</p>
	<p>Denna produkt omfattas av bestämmelserna i det europeiska direktivet 2012/19/EC. Symbolen som visar en soptunna korsad anger att produkten kräver separat sophämtning i EU. Detta gäller för produkten och alla tillbehör märkta med denna symbol. Produkter märkta som sådana får inte slängas tillsammans med vanligt hushållsavfall, utan måste lämnas till en insamlingsplats för återvinning av elektriska och elektroniska apparater</p>

**Tillverkare:** Shanghaimuxinmuyeyouxiangongsi

**Adress:** Shuangchenglu 803nong11hao1602A-1609shi, baoshanqu, shanghai 200000 CN.

**Importerad till AUS:** SIHAO PTY LTD, 1 ROKEVA STREETEASTWOOD NSW 2122 Australien

**Importerad till USA:** Sanven Technology Ltd., Suite 250, 9166 Anaheim Place, Rancho Cucamonga, CA 91730



E-CrossStu GmbH  
Mainzer Landstr.69, 60329 Frankfurt am Main.



YH CONSULTING LIMITED.  
C/O YH Consulting Limited Office 147, Centurion House,  
London Road, Staines-upon-Thames, Surrey, TW18 4AX



**VEVOR**®

**TOUGH TOOLS, HALF PRICE**

**Teknisk support och e-garanticertifikat**

**[www.vevor.com/support](http://www.vevor.com/support)**