

Operator's Manual

**CRAFTSMAN**®

2.2 cu. in./36cc 2-Cycle  
**GASOLINE CHAIN SAW**

Model No.  
358.352162 – 16 in. Bar

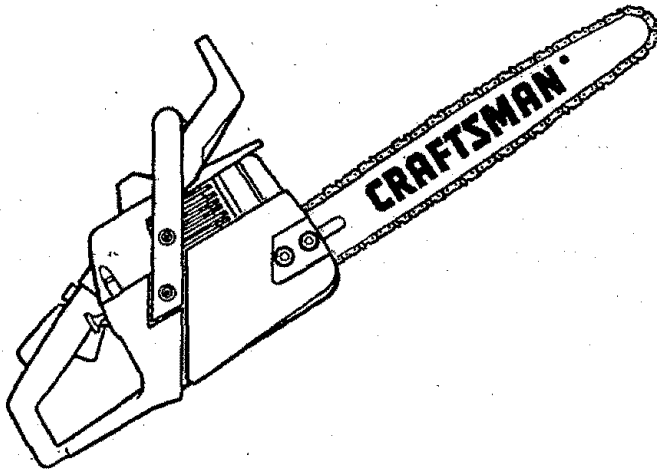

**WARNING:**  
Read and follow all Safety Rules and Operating Instructions before first use of this product.



For answers to your questions about this product:  
Call 7 am–7 pm, Mon.–Sat., or 10 am–7 pm, Sun.  
**1-800-235-5878** (Hours listed are Central Time)

Sears, Roebuck and Co., Hoffman Estates, IL 60179 USA

SAFETY

ASSEMBLY

OPERATION

MAINTENANCE

PARTS LIST

ESPAÑOL

## TABLE OF CONTENTS

Warranty	2	Storage	16
Safety Rules	2	Trouble Shooting Chart	17
Assembly	5	Parts List	19
Operation	6	Spanish	22
Maintenance	11	Parts & Ordering	Back
Service and Adjustments	14		

## WARRANTY STATEMENT

### FULL ONE YEAR WARRANTY ON CRAFTSMAN® GAS CHAIN SAW

For one year from the date of purchase, when this Craftsman Gas Chain Saw is maintained, lubricated and tuned up according to the owner's manual, Sears will repair, free of charge, any defect in material or workmanship.

This warranty excludes the bar, chain, spark plug and air filter, which are expendable parts, and become worn during normal use.

If this Gas Chain Saw is used for commercial or rental purposes, this warranty applies for 30 days from the date of purchase.

WARRANTY SERVICE IS AVAILABLE BY RETURNING THIS CHAIN SAW TO THE NEAREST SEARS SERVICE CENTER IN THE UNITED STATES.

This warranty gives you specific legal rights, and you may also have other rights which vary from state to state.

Sears, Roebuck and Co., D/817 WA, Hoffman Estates, IL 60179

## SAFETY RULES

**WARNING:** Always disconnect spark plug wire when making repairs except for carburetor adjustments. Because a chain saw is a high-speed woodcutting tool, careless or improper use of this tool can cause serious injury.

### PLAN AHEAD

- Restrict the use of your saw to adult users who understand and can follow the safety rules, precautions, and operating instructions found in this manual.

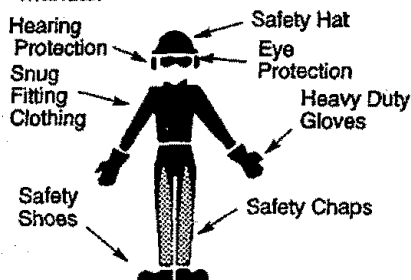

duty, non-slip gloves; eye protection such as non-fogging, vented goggles or face screen; an approved safety hard hat; and sound barriers (ear plugs or mufflers) to protect your hearing. Regular users should have hearing checked regularly as chain saw noise can damage hearing. Secure hair above shoulder length.

- Keep all parts of your body away from the chain when the engine is running.
- Keep children, bystanders, and animals at least 30 feet (10 meters) away from the work area when starting and using the saw.
- Do not handle or operate a chain saw when you are fatigued, ill, or upset, or if you have taken alcohol, drugs, or medication. You must be in good physical condition and mentally alert. If you have any condition that might be aggravated by strenuous work, check with doctor before operating.
- Do not start cutting until you have a clear work area, secure footing, and especially if you are felling a tree, a retreat path.

- Wear protective gear. Always use steel-toed safety footwear with non-slip soles; snug-fitting clothing; heavy-

## OPERATE YOUR SAW SAFELY

- Do not operate with one hand. Serious injury to the operator, helpers, or bystanders may result from one-handed operation. A chain saw is intended for two-handed use.
- Operate the chain saw only in a well-ventilated outdoor area.
- Do not operate saw from a ladder or in a tree, unless you are specifically trained to do so.
- Make sure the chain will not make contact with any object while starting the engine. Never try to start the saw when the guide bar is in a cut.
- Do not put pressure on the saw, especially at the end of the cut. Doing so can cause you to lose control when the cut is completed.
- Stop engine before setting saw down.
- Hand carry saw only when engine is stopped. Carry with muffler away from body; guide bar & chain projecting behind you; guide bar preferably covered with a scabbard.

## MAINTAIN YOUR SAW IN GOOD WORKING ORDER

- Have all chain saw service performed by a qualified service dealer except the items listed in the maintenance section of this manual.
- Make certain the saw chain stops moving when the throttle trigger is released. For correction, refer to "Carburetor Adjustments."
- Keep the handles dry, clean, and free from oil or fuel mixture.
- Keep caps and fasteners securely tightened.
- Use only Craftsman accessories and replacement parts as recommended. Never modify your saw.

## HANDLE FUEL WITH CAUTION

- Do not smoke while handling fuel or while operating the saw.
- Eliminate all sources of sparks or flame in areas where fuel is mixed or poured.
- Mix and pour fuel in an outdoor area and use an approved, marked container for all fuel purposes. Wipe up all fuel spills before starting saw.
- Move at least 10 feet (3 meters) from fueling site before starting.
- Turn the engine off and let saw cool in a non-combustible area, not on dry leaves, straw, paper, etc. Slowly remove fuel cap and refuel unit.

- Store the unit and fuel in a cool, dry well ventilated space where fuel vapors cannot reach sparks or open flames from water heaters, electric motors or switches, furnaces, etc.

## GUARD AGAINST KICKBACK

Follow all safety rules to help avoid kickback and other forces which can result in serious injury.

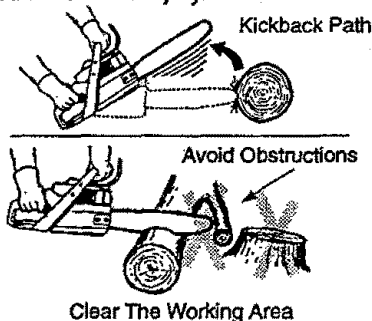

**WARNING:** Rotational Kickback can occur when the moving chain contacts an object at the upper portion of the tip of the guide bar. Contact at the upper portion of the tip of the guide bar can cause the chain to dig into the object, which stops the chain for an instant. The result is a lightning fast, reverse reaction which kicks the guide bar up and back toward the operator.

Pinch-Kickback and Pull-In occur when the chain is suddenly stopped by being pinched, caught, or by contacting a foreign object in the wood. This sudden stopping of the chain results in a reversal of the chain force used to cut wood and causes the saw to move in the opposite direction of the chain rotation. Pinch-Kickback drives the saw straight back toward the operator. Pull-In pulls the saw away from the operator.

## REDUCE THE CHANCE OF KICKBACK

- Recognize that kickback can happen. With a basic understanding of kickback, you can reduce the element of surprise which contributes to accidents.
- Never let the moving chain contact any object at the tip of the guide bar.
- Keep working area free from obstructions such as other trees, branches, rocks, fences, stumps, etc. Eliminate or avoid any obstruction that your saw chain could hit while cutting.
- Keep saw chain sharp and properly tensioned. A loose or dull chain can

increase the chance of kickback. Follow manufacturer's chain sharpening and maintenance instructions. Check tension at regular intervals, but never with engine running. Make sure bar clamp nuts are securely tightened.

- Begin and continue cutting at full speed. If the chain is moving at a slower speed, there is greater chance of kickback occurring.
- Use extreme caution when reentering a cut.
- Do not attempt cuts starting with the tip of the bar (plunge cuts).
- Watch for shifting logs or other forces that could close a cut and pinch or fall into chain.
- Use the specified Reduced-Kickback Guide Bar and Low-Kickback Chain.

#### Avoid Pinch-Kickback:

- Be extremely aware of situations or obstructions that can cause material to pinch the top of or otherwise stop the chain.
- Do not cut more than one log at a time.
- Do not twist saw as bar is withdrawn from an undercut when bucking.

#### Avoid Pull-In:

- Always begin cutting with the engine at full speed and the saw housing against wood.
- Use wedges made of plastic or wood. Never use metal to hold the cut open.

### MAINTAIN CONTROL

Stand to the left of the saw

Thumb on underside of handlebar

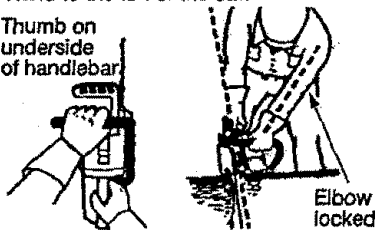

Never reverse hand positions.

- A good, firm grip on the saw with both hands will help you maintain control. Don't let go. Grip the rear handle with your right hand whether you are right or left handed. Wrap the fingers of your left hand over and around the front handlebar, and your left thumb under the front handlebar. Keep your left arm straight with the elbow locked.
- Position your left hand on the front handlebar so it is in a straight line with your right hand on the rear handle when making bucking cuts. Stand slightly to the left side of the saw to

keep your body from being in a direct line with the cutting chain.

- Stand with your weight evenly balanced on both feet.
- Do not overreach. You could be drawn or thrown off balance and lose control.
- Do not cut above shoulder height. It is difficult to maintain control of saw above shoulder height.

### KICKBACK SAFETY FEATURES

**WARNING:** The following features are included on your saw to help reduce hazard of kickback; however, such features will not totally eliminate this danger. Do not rely only on safety devices.

- Handguard: designed to reduce the chance of your left hand contacting the chain if your hand slips off the front handlebar.
- Position of front and rear handlebars: designed with distance between handles and "in-line" with each other. The spread and "in-line" position of the hands provided by this design work together to give balance and resistance in controlling the pivot of the saw back toward the operator if kickback occurs.
- Reduced-Kickback Guide Bar: designed with a small radius tip which reduces the size of the kickback danger zone. This type bar has been demonstrated to significantly reduce the number and seriousness of kickbacks when tested in accordance with ANSI B175.1.

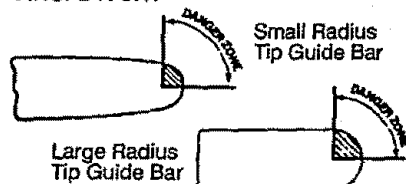

- Low-Kickback Chain: has met kickback performance requirements when tested on a representative sample of chain saws below 3.8 cubic inch displacement specified in ANSI B175.1. Low-Kickback Chain

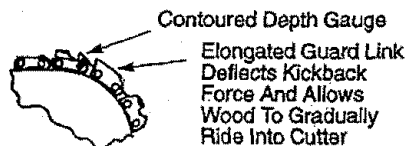

**SAFETY NOTICE:** Exposure to vibrations through prolonged use of gasoline powered hand tools could cause blood vessel or nerve damage in the fingers, hands, and joints of people

prone to circulation disorders or abnormal swelling. Prolonged use in cold weather has been linked to blood vessel damage in otherwise healthy people. If symptoms occur such as numbness, pain, loss of strength, change in skin color or texture, or loss of feeling in the fingers, hands, or joints, discontinue the use of this tool and seek medical attention. An anti-vibration system does not guarantee the avoidance of these problems. Users who operate power tools on a continual and regular basis must closely monitor their physical condition and the condition of this tool.

**CHAIN BRAKE** If this saw is to be used for commercial logging, you must order and install a chain brake to comply with Federal OSHA Regulations for Commercial Logging. Contact your Sears Service Center or call 1-800-235-5878.

**SPARK ARRESTOR:** Your saw is equipped with a temperature limiting

muffler and spark arresting screen which meets the requirements of California Codes 4442 and 4443. All U.S. forest land and the states of California, Idaho, Maine, Minnesota, New Jersey, Oregon, and Washington require by law that many internal combustion engines be equipped with a spark arrestor screen. If you operate a chain saw in a state or locale where such regulations exist, you are legally responsible for maintaining the operating condition of these parts. Failure to do so is a violation of the law. Refer to Customer Responsibilities chart in the MAINTENANCE section.

**STANDARDS:** This chain saw is listed by Underwriters Laboratories, Inc. in accordance with American National Standards for Gasoline-Powered Chain Saws Safety Requirements (ANSI B175.1-1991).

## ASSEMBLY

### CARTON CONTENTS

Check carton contents against the following list.

#### Model 358.352162

- Chain Saw (fully assembled)
- Bar tool
- Chain
- Carrying Case
- Gloves
- Gas Can
- Bar & Chain Lube
- 2-cycle engine oil
- Examine parts for damage. Do not use damaged parts.

- If you need assistance or find that parts are missing or damaged, please call 1-800-235-5878.

**NOTE:** It is normal to hear the fuel filter rattle in an empty fuel tank.

Your unit has been factory tested and the carburetor precisely adjusted. As a result you may smell gasoline or find a drop of oil/fuel residue on the muffler when you unpack the unit.

### ASSEMBLY

Your saw is fully assembled; no assembly is necessary.

## OPERATION

### KNOW YOUR SAW

READ THIS OPERATOR'S MANUAL AND SAFETY RULES BEFORE OPERATING YOUR CHAIN SAW. Compare the illustrations with your unit to familiarize yourself with the location of the various controls and adjustments. Save this manual for future reference.

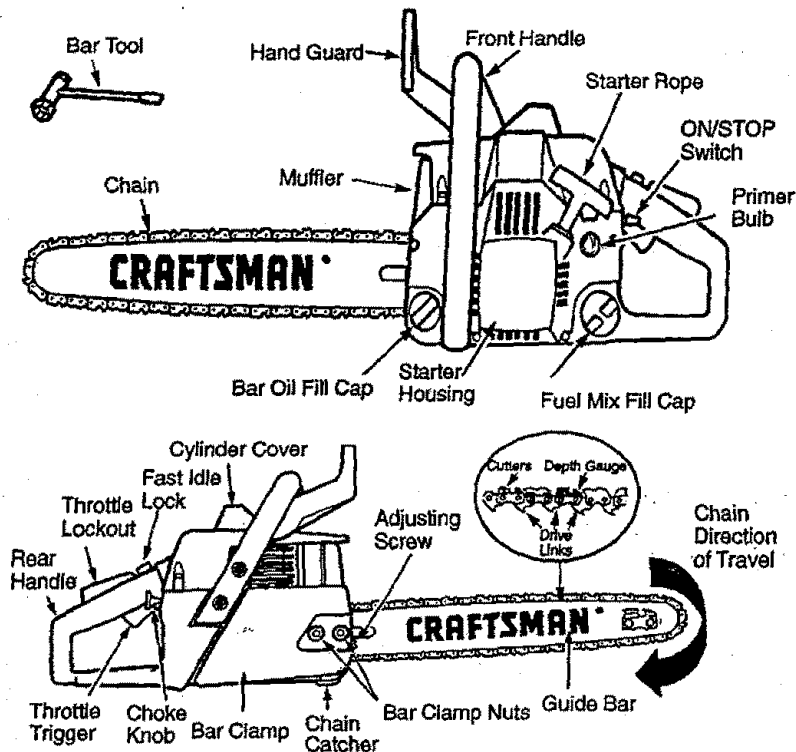

#### ON/STOP SWITCH

The ON/STOP Switch is used to stop the engine.

#### THROTTLE TRIGGER

The throttle trigger controls engine speed.

#### THROTTLE LOCKOUT

The throttle lockout must be pressed before you can squeeze the throttle trigger. This feature prevents you from accidentally squeezing the trigger.

#### FAST IDLE LOCK

The fast idle lock holds the throttle trigger in the starting position. Activate the fast idle lock by pressing the throttle lockout and squeezing the throttle trigger. With the throttle trigger squeezed, press the fast idle lock. Release the

throttle lockout and trigger while holding the fast idle lock button.

#### CHOKE KNOB

The Choke Knob activates the choke to provide additional fuel to the engine during cold starting.

#### PRIMER BULB

The Primer Bulb circulates fuel to the carburetor to provide quicker starting.

#### CHAIN TENSION

It is normal for a new chain to stretch during first 30 minutes of operation. You should check your chain tension frequently. See Chain Tension under the Service and Adjustments section.

## BEFORE STARTING ENGINE

**WARNING:** Be sure to read the fuel handling information in the safety rules section of this manual before you begin. If you do not understand the fuel handling information do not attempt to fuel your unit. Seek help from someone that does understand the information or call the customer assistance help line at 1-800-235-5878.

## GUIDE BAR AND CHAIN OIL

The chain oiler provides continuous lubrication to the chain and guide bar. Be sure to fill the bar oil tank when you fill the fuel tank (Capacity = 6.8 fl. oz.). For maximum guide bar and chain life, we recommend you use Craftsman chain saw bar oil. If Craftsman bar oil is not available, you may use a good grade SAE 30 oil until you are able to obtain Craftsman brand. The oil output is automatically metered during operation. Your saw will use approximately one tank of bar oil for every tank of fuel mix. Always fill the bar oil tank when you fill the fuel tank.

## FUELING ENGINE

This engine is certified to operate on unleaded gasoline. Before operation, gasoline must be mixed with a good quality 2-cycle air-cooled engine oil. We recommend Craftsman-brand oil. Mix gasoline and oil at a ratio of 40:1 (A 40:1 ratio is obtained by mixing 3.2 ounces of oil with 1 gallon of unleaded gasoline). **DO NOT USE** automotive oil or boat oil. These oils will cause engine damage. When mixing fuel follow the instructions printed on the container. Once oil is added to the gasoline, shake container momentarily to assure that the fuel is thoroughly mixed. Always read and follow the safety rules relating to fuel before fueling your unit.

## IMPORTANT

Experience indicates that alcohol blended fuels (called gasohol or using ethanol or methanol) can attract moisture which leads to separation and formation of acids during storage. Acidic gas can damage the fuel system of an engine while in storage.

To avoid engine problems, the fuel system should be emptied before storage for 30 days or longer. Drain the gas tank, start the engine and let it run until the fuel

lines and carburetor are empty. Use fresh fuel next season. See STORAGE instructions for additional information.

Never use engine or carburetor cleaner products in the fuel tank or permanent damage may occur.

See the STORAGE section for additional information.

## STOPPING YOUR ENGINE

- Move On/Stop switch to STOP.
- If engine does not stop, pull choke knob out fully.

## STARTING YOUR ENGINE COLD ENGINE OR WARM ENGINE AFTER RUNNING OUT OF FUEL

- Fuel engine with 40:1 fuel mix.
- Fill bar oil tank with bar oil.
- Prime engine by pressing primer bulb six times.
- Move On/Stop switch to ON.

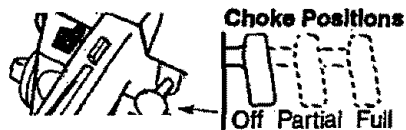
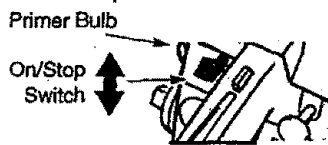

- Actuate choke by pulling choke knob fully out.
- Set saw on the ground. Grip front handle with your left hand and place right foot through rear handle.

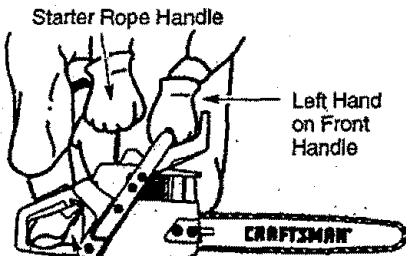

- Set fast idle by depressing the throttle lock with your right hand. Then, squeeze and hold throttle trigger. With your thumb, press the fast idle lock down and hold. Next, release the throttle trigger.
- **DO NOT** squeeze throttle trigger during starting; otherwise, it will be necessary to reset the fast idle lock.

**NOTE:** When pulling the starter rope, do not use the full extent of the rope. Do not let starter rope snap back. Hold handle. Let rope rewind slowly.

- Pull starter rope handle firmly and quickly with your right hand until the engine attempts to start, but no more than 5 pulls. Then, push in choke knob to the partial position. Resume pulling handle until engine starts.
- Above 40°F, allow engine to run for approximately 5 seconds. Push the choke knob in to the OFF position; then squeeze and release throttle trigger to allow engine to idle.
- Below 40°F, allow engine to warm up for 30 seconds to 1 minute with choke at partial position. Push choke knob in to the OFF position; then squeeze and release throttle trigger to allow engine to idle.
- To stop engine, move On/Stop switch to the STOP position.

#### **STARTING A WARM ENGINE**

DO NOT use the choke to start a warm engine or flooding and hard starting may occur.

- Move On/Stop switch to ON.
- Set fast idle lock.
- Be sure choke is in the OFF position.
- With saw on ground, grip front handle with left hand and place your right foot through rear handle.
- Pull starter rope handle until engine starts.
- Squeeze and release throttle trigger to return engine to idle speed.

#### **DIFFICULT STARTING OR STARTING A FLOODED ENGINE**

The engine may be flooded if it has not started after 10 pulls. Flooded engines can be cleared of excess fuel with the following procedure:

- Engage the fast idle lock.
- Verify that the On/Stop switch is in the ON position.
- Push choke knob to the OFF position.
- With saw on ground, grip front handle with left hand and place right foot through rear handle.
- Pull starter rope handle until engine starts.
- Starting could require many pulls depending on how badly the unit is flooded. If engine still fails to start, refer to the TROUBLESHOOTING chart or call 1-800-235-5878.

#### **OPERATING TIPS**

- Check chain tension before first use and after 1 minute of operation. See Chain Tension in the Maintenance section.
- Cut wood only. Do not cut metal, plastics, masonry, non-wood building materials, etc.
- Stop the saw if the chain strikes a foreign object. Inspect the saw and repair parts as necessary.
- Keep the chain out of dirt and sand. Even a small amount of dirt will quickly dull a chain and increase the possibility of kickback.
- Practice cutting a few small logs using the following steps. This will help you get the "feel" of using your saw before you begin a major sawing operation.
  - Squeeze the throttle trigger and allow the engine to reach full speed before cutting.
  - Begin cutting with the saw frame against the log.
  - Keep the engine at full speed the entire time you are cutting.
  - Allow the chain to cut for you. Exert only light downward pressure.
  - Release the throttle trigger as soon as the cut is completed, allowing the engine to idle. If you run the saw at full throttle without a cutting load, unnecessary wear can occur.
  - To avoid losing control when cut is complete, do not put pressure on saw at end of cut.
  - Stop engine before setting saw down.

#### **TREE FELLING TECHNIQUES**

**WARNING:** Check for broken or dead branches which can fall while cutting causing serious injury. Do not cut near buildings or electrical wires if you do not know the direction of tree fall, nor cut at night since you will not be able to see well, nor during bad weather such as rain, snow, or strong winds, etc.

- Carefully plan your sawing operation in advance.
- Clear the work area. You need a clear area all around the tree so you can have secure footing.
- Study the natural conditions that can cause the tree to fall in a particular direction. These conditions include:
  - The wind direction and speed.
  - The lean of the tree. The lean of a tree might not be apparent due to uneven or sloping terrain. Use a

plumb or level to determine the direction of tree lean.

- Weight and branches on one side.
- Surrounding trees and obstacles.
- Look for decay and rot. If the trunk is rotted, it can snap and fall toward the operator.
- Make sure there is enough room for the tree to fall. Maintain a distance of 2-1/2 tree lengths from the nearest person or other objects. Engine noise can drown out a warning call.
- Remove dirt, stones, loose bark, nails, staples, and wire from the tree where cuts are to be made.

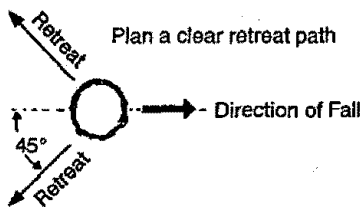

### FELLING LARGE TREES

(6 inches in diameter or larger)

The notch method is used to fell large trees. A notch is cut on the side of the tree in the desired direction of fall. After a felling cut is made on the opposite side of tree, the tree will tend to fall in the direction of the notch.

**NOTE:** If tree has large buttress roots, remove them before making the notch.

### NOTCH CUT AND FELLING TREE

- Make notch cut by cutting the top of the notch first. Cut through 1/3 of the diameter of the tree. Next complete the notch by cutting the bottom. See illustration. Once the notch is cut, remove the wedge of wood from tree.

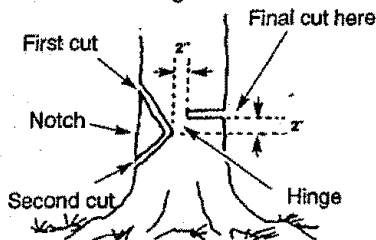

- After removing the wood, make the felling cut on the opposite side of the notch. This is done by making a cut about two inches higher than the center of the notch. This will leave enough uncut wood between the felling cut and the notch to form a hinge.

This hinge will help prevent the tree from falling in the wrong direction.

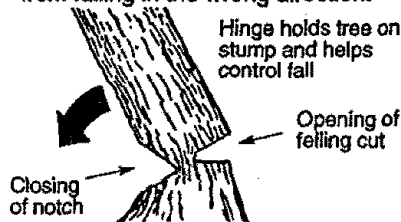

**NOTE:** Before felling cut is complete, use wedges to open the cut when necessary to control the direction of fall. To avoid kickback and chain damage, use wood or plastic wedges, but never steel or iron wedges.

- Be alert to signs that the tree is ready to fall: cracking sounds, widening of the felling cut, or movement in the upper branches.
- As tree starts to fall, stop saw, put it down, and get away quickly on your planned retreat path.
- Be extremely cautious with partially fallen trees that may be poorly supported. When a tree doesn't fall completely, set the saw aside and pull down the tree with a cable winch, block and tackle, or tractor. Do not use your saw to cut down a partially fallen tree.

### CUTTING A FALLEN TREE (BUCKING)

Bucking is the term used for cutting a fallen tree to the desired log size.

**WARNING:** Do not stand on the log being cut. Any portion can roll causing loss of footing and control. Do not stand downhill of the log being cut.

### IMPORTANT POINTS

- Cut only one log at a time.
- Cut shattered wood very carefully; sharp pieces of wood could be flung toward operator.
- Use a sawhorse to cut small logs. Never allow another person to hold the log while cutting and never hold the log with your leg or foot.
- Do not cut in an area where logs, limbs, and roots are tangled. Drag logs into a clear area before cutting them.

### BUCKING TECHNIQUES

**WARNING:** If saw becomes pinched or hung in a log, don't try to force it out. You can lose control of the saw resulting in injury and/or damage to the saw. Stop the saw, drive a wedge of plastic

or wood into the cut until the saw can be removed easily. Restart saw and carefully reenter the cut. Do not use a metal wedge. Do not attempt to restart your saw when it is pinched or hung in a log.

Use a wedge to remove pinched saw

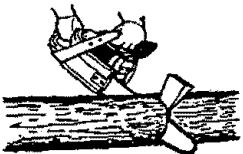

Turn saw OFF and use a plastic or wooden wedge to force cut open.

Overcutting begins on the top side of the log with the bottom of the saw against the log. When overcutting use light downward pressure.

Overcutting



Undercutting

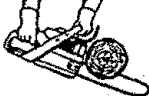

Undercutting involves cutting on the underside of the log with top of saw against the log. When undercutting use light upward pressure. Hold saw firmly and maintain control. The saw will tend to push back toward you.

**WARNING:** Never turn saw upside down to undercut. The saw cannot be controlled in this position.

Always make your first cut on the compression side of the log.

First cut on compression side of log

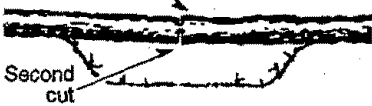

First cut on compression side of log

#### BUCKING WITHOUT A SUPPORT

- Overcut through 1/3 of the diameter of the log.
- Roll the log over and finish with a second overcut.
- Watch for logs with a compression side. See illustration above for cutting logs with a compression side.

Using a log for support

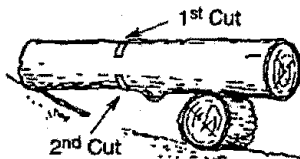
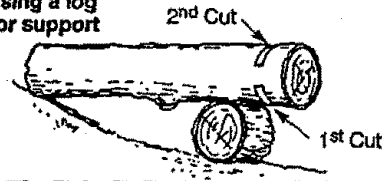

#### BUCKING USING A LOG OR SUPPORT STAND

- Remember your first cut is always on the compression side of the log. (Refer to the illustration below for your first and second cut).
- Your first cut should extend 1/3 of the diameter of the log.
- Finish with your second cut.

Using a support stand

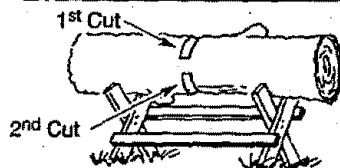
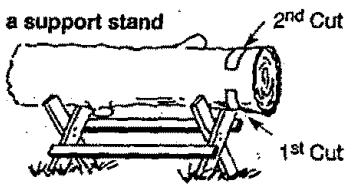

#### LIMBING AND PRUNING

**WARNING:** Never climb into a tree to limb or prune. Do not stand on ladders, platforms, a log, or in any position which can cause you to lose your balance or control of the saw.

#### IMPORTANT POINTS

- Watch out for springpoles. Springpoles are small size limbs which can whip toward you, or pull you off balance. Use extreme caution when cutting small size limbs.
- Be alert for springback. Watch out for branches that are bent or under pressure. Avoid being struck by the branch or the saw when the tension in the wood fibers is released.
- Frequently clear branches out of the way to avoid tripping over them.

### LIMBING

- Limb a tree only after it is cut down.
- Leave the larger limbs underneath the felled tree to support the tree as you work.
- Start at the base of the felled tree and work toward the top, cutting branches and limbs. Remove small limbs with one cut.
- Keep the tree between you and the chain.
- Remove larger, supporting branches with the 1/3, 2/3 cutting techniques described in the bucking section.
- Always use an overcut to cut small and freely hanging limbs. Undercutting could cause limbs to fall and pinch the saw.

branches are higher than your shoulder. Get a professional to do the job.

- Make your first cut 1/3 of the way through the bottom of the limb.
- Next make a second cut all the way through the limb.
- Finish the pruning operation by using an overcut so that the stump of the limb protrudes 1 to 2 inches from the trunk of the tree.

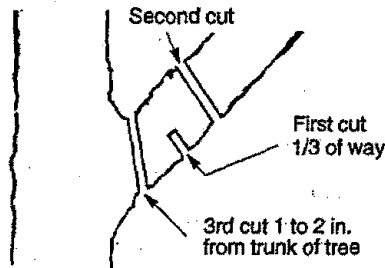

### PRUNING

**WARNING:** Limit pruning to limbs shoulder height or below. Do not cut if

## MAINTENANCE

### CUSTOMER RESPONSIBILITIES

Fill in dates as you complete regular service	Before Use	After Use	Every 5 hrs.	Every 25 hrs.	Yearly	Service Dates
Check for damaged/worn parts	✓					
Check for loose fasteners/parts	✓					
Check chain tension	✓					
Check chain sharpness	✓					
Check guide bar	✓					
Clean unit & labels		✓				
Clean air filter			✓			
Clean/inspect spark arrestor screen & inspect muffler				✓		
Replace spark plug					✓	

### GENERAL RECOMMENDATIONS

The warranty on this unit does not cover items that have been subjected to operator abuse or negligence. To receive full value from the warranty, the operator must maintain unit as instructed in this manual. Various adjustments will need to be made periodically to properly maintain your unit.

- Once a year, replace the spark plug, air filter element, and check guide bar and chain for wear. A new spark plug and air filter element assures proper air-fuel mixture and helps your engine

run better and last longer.

**WARNING:** Disconnect the spark plug before performing maintenance except for carburetor adjustments.

### LUBRICATION

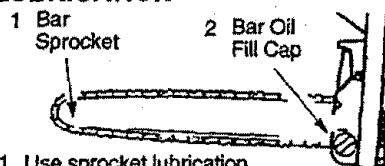

- 1 Use sprocket lubrication
- 2 Use Craftsman chain saw bar oil

## CHECK FOR DAMAGED OR WORN PARTS

Replacement of damaged/worn parts should be referred to your Sears Service Center.

**NOTE:** It is normal for a small amount of oil to appear under the saw after engine stops. Do not confuse this with a leaking oil tank.

- On/Stop Switch – Ensure On/Stop switch functions properly by moving the switch to the "Stop" position. Make sure engine stops; then restart engine and continue.
- Fuel Tank – Do not use saw if fuel tank shows signs of damage or leaks.
- Oil Tank – Do not use saw if oil tank shows signs of damage or leaks.

## CHECK FOR LOOSE FASTENERS AND PARTS

- Bar Clamp Nut
- Chain
- Muffler
- Cylinder Shield
- Air Filter
- Clutch Drum/Sprocket
- Handle Screws
- Vibration Mounts
- Starter Housing
- Handguard

## CHECK CHAIN TENSION

- Use the screwdriver end of the bar tool to move chain around guide bar to ensure kinks do not exist. The chain should rotate freely.

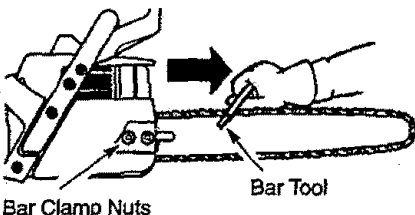

Bar Clamp Nuts

- Loosen bar clamp nuts until they are finger tight against the bar clamp.
- Turn adjusting screw clockwise until chain barely touches the bottom of guide bar.



- Using bar tool, roll chain around guide bar to ensure all links are in bar groove.

Adjusting Screw – 1/4 Turn



- Lift up tip of guide bar to check for sag. Release tip of guide bar, then turn adjusting screw 1/4 turn clockwise. Repeat until sag does not exist.
- While lifting tip of guide bar, tighten bar clamp nuts with the bar tool. Torque to 10-15 ft-lbs.

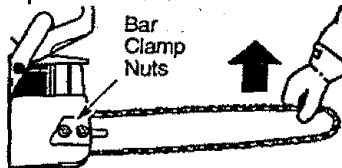

- Use the screwdriver end of the bar tool to move chain around guide bar.
- If chain does not rotate, it is too tight. Slightly loosen bar clamp nuts and turn adjusting screw 1/4 turn counter-clockwise. Retighten bar clamp nuts.
- If chain is too loose, it will sag below the guide bar. DO NOT operate the saw if the chain is loose.

## CHECK CHAIN SHARPNESS

A sharp chain makes wood chips. A dull chain makes a sawdust powder and cuts slowly.

## CHAIN SHARPENING

Chain sharpening requires special tools. You can purchase sharpening tools at Sears or go to a professional chain sharpener.

## CHECK GUIDE BAR

Conditions which require guide bar maintenance:

- Saw cuts to one side or at an angle.
  - Saw has to be forced through the cut.
  - Inadequate supply of oil to bar/chain.
- Check the condition of guide bar each time chain is sharpened. A worn guide bar will damage the chain and make cutting difficult. To maintain guide bar:
- Move On/Stop switch to "Stop."
  - Remove bar and chain from saw.
  - Clean all sawdust and any other debris from the guide bar groove and sprocket hole after each use.

Remove Sawdust From Guide Bar Groove



Sprocket Hole



- Add lubricant to sprocket hole after each use.
- Burring of guide bar rails is a normal process of rail wear. Remove these burrs with a flat file.
- When rail top is uneven, use a flat file to restore square edges and sides.

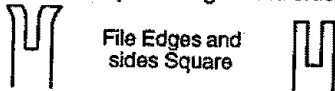

**Worn Groove**  
 Replace guide bar when the groove is worn, the guide bar is bent or cracked, or when excess heating or burring of the rails occurs. If replacement is necessary, use only the guide bar specified for your saw in the repair parts list or on the decal located on the chain saw.

#### CLEAN UNIT & LABELS

- Clean the unit using a damp cloth with a mild detergent.
- Wipe off unit with a clean dry cloth.

#### CLEAN AIR FILTER

A dirty air filter decreases the life and performance of the engine and increases fuel consumption and harmful emissions. Always clean your air filter after 15 tanks of fuel or 5 hours of operation, whichever comes first. Clean more frequently in dusty conditions. A used air filter can never be completely cleaned. It is advisable to replace your air filter with a new one after every 50 hours of operation, or annually, whichever comes first. To clean filter:

- Loosen 3 screws on cylinder cover.
- Remove cylinder cover.
- Remove air filter.
- Clean the air filter using hot soapy water. Rinse with clean cool water. Air dry completely before reinstalling.
- Lightly oil air filter before installing to improve the efficiency of air filter. Use 2-cycle engine oil or motor oil (SAE 30). Squeeze excess oil from filter.
- Reinstall air filter.
- Reinstall cylinder cover and 3 screws (15-20 in.-lbs.).

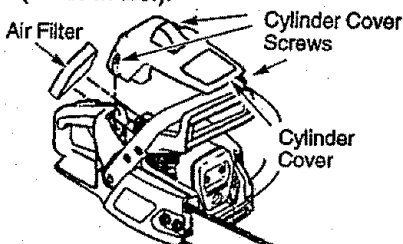

#### INSPECT MUFFLER AND SPARK ARRESTOR SCREEN

As the unit is used, carbon deposits build up on the muffler and spark arrestor screen, and must be removed to avoid creating a fire hazard or affecting engine performance. Replace the spark arrestor screen if breaks occur.

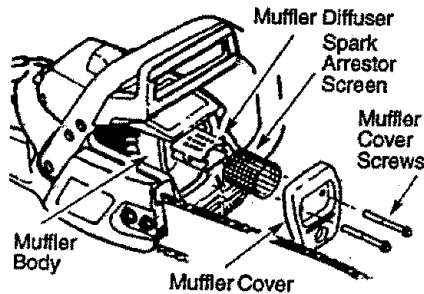

#### CLEANING THE SPARK ARRESTOR SCREEN

Cleaning is required every 25 hours of operation or annually, whichever comes first.

- Loosen and remove the 2 muffler cover screws.
- Remove the muffler cover (cover snaps off muffler body).
- Remove muffler diffuser and spark arrestor screen assembly. Notice the orientation of these parts for reassembling.
- Clean the spark arrestor screen with a wire brush. Replace screen if breaks are found.
- Replace any broken or cracked muffler parts.
- Reinstall diffuser and spark arrestor screen assembly with round holes facing up.
- Reinstall muffler cover and 2 screws (7-8 ft.-lbs.).

#### REPLACE SPARK PLUG

The spark plug should be replaced each year to ensure the engine starts easier and runs better. Ignition timing is fixed and nonadjustable.

- Loosen 3 screws on cylinder cover.
- Remove the cylinder cover.
- Pull off the spark plug boot.
- Remove spark plug from cylinder and discard.

- Replace with Champion RCJ7Y spark plug and tighten with a 3/4 inch socket wrench (10-12 ft-lbs). Spark plug gap should be .025 in.
- Reinstall the spark plug boot.
- Reinstall the cylinder cover and 3 screws (15-20 in-lbs).

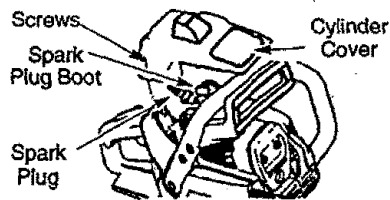

## SERVICE AND ADJUSTMENTS

### CHAIN REPLACEMENT

**CAUTION:** Wear protective gloves when handling chain. The chain is sharp and can cut you even when it is not moving.

It is normal for a new chain to stretch during the first 15 minutes of operation. You should recheck your chain tension frequently and adjust the chain tension as required. See Chain Tension section.

- Move On/Stop switch to the Stop position.
- Replace the old chain when it becomes worn or damaged.
- Use only the Low-Kickback replacement chain specified in the repair parts list. The correct replacement bar and chain is also specified on a decal located on the chain saw.
- See your Sears Service Center to replace and sharpen individual cutters on your chain.
- Remove bar clamp nuts.
- Remove bar clamp.
- Remove the old chain.

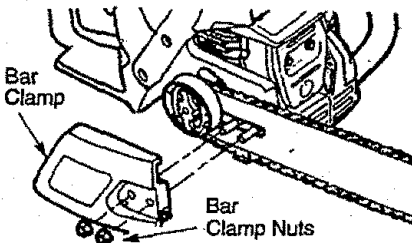

- Turn adjusting screw by hand counterclockwise until adjusting pin just touches the stop.
- Slide guide bar behind clutch drum until guide bar stops against clutch drum sprocket.
- Carefully remove new chain from package. Hold chain with the drive links as shown.

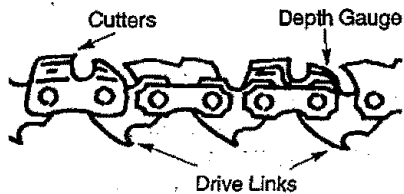

- Place chain over and behind clutch.
- Fit bottom of drive links between teeth in sprocket nose.
- Fit chain drive links into bar groove.
- Pull guide bar forward until chain is snug in guide bar groove.
- Now, install bar clamp making sure the adjusting pin is positioned in the lower hole in the guide bar.

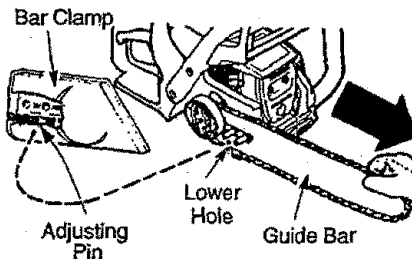

- Install bar clamp nuts and finger tighten only. Do not tighten any further at this point.

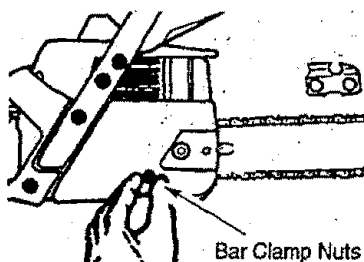

### CHAIN ADJUSTMENT

See "Chain Tension" in Maintenance section.

## CLEAN FUEL FILTER

To clean fuel filter, drain your unit by running dry of fuel, remove fuel cap/retainer assembly from tank. Pull filter from tank and remove from line. Clean with mild detergent and rinse. Dry thoroughly, reassemble.

## CARBURETOR ADJUSTMENT

**WARNING:** The chain will be moving during most of this procedure. Wear your protective equipment and observe all safety precautions. During the low speed mixture adjustment recheck idle speed after each turn of the screw. The chain must not move at idle speed.

Carburetor adjustment is critical and if done improperly can permanently damage the engine as well as the carburetor. If you require further assistance or are unsure about performing this procedure, call our customer assistance help line at 1-800-235-5878.

Old fuel, a dirty air filter, dirty fuel filter, or flooding may give the impression of an improperly adjusted carburetor. Check these conditions before adjusting the carburetor.

The carburetor has been carefully set at the factory. Adjustments may be necessary if you notice any of the following conditions:

- Chain moves at idle. See "Idle Speed" under adjusting procedure.
- Saw will not idle. See "Idle Speed" and "Low Speed Mixture" under adjusting procedure.
- Engine dies or hesitates when it should accelerate. See "Acceleration Check" under adjusting procedure.
- Loss of cutting power. See "High Speed Mixture H" under adjusting procedure.

There are three adjustment screws on the carburetor. They are labeled H, L, and T. They are located in the area just above the primer bulb.

## CARBURETOR PRESETS

When making adjustments, do not force the plastic limiter caps beyond the stops or damage will occur.

If carburetor presets are not needed, proceed to "Idle Speed-T."

- Turn both mixture screws counterclockwise until they stop.
- Turn the idle speed screw clockwise until it stops. Now turn counterclockwise 4-1/2 full turns.

Start motor, let it run for 3 minutes, and proceed to the adjustment section. If engine does not start, refer to troubleshooting chart or call 1-800-235-5878. If engine performance is acceptable at the preset positions and there is no chain movement at idle, no further adjustment is necessary.

## ADJUSTING PROCEDURE

### Idle Speed-T

Allow engine to idle. Adjust speed until engine runs without chain movement or stalling.

- Turn clockwise to increase engine speed if engine stalls or dies.
- Turn counterclockwise to decrease speed.

No further adjustments are necessary if chain does not move at idle speed and if performance is satisfactory.

### Low Speed Mixture-L

Allow engine to idle. Then accelerate the engine and note performance. If engine hesitates, bogs down, or smokes during acceleration, turn mixture screw clockwise in 1/16-turn increments until performance is satisfactory. Repeat this procedure as necessary for proper adjustment. After completing adjustments, check for acceleration and chain movement at idle. Reset if necessary.

### High Speed Mixture-H

DO NOT operate engine at full throttle for prolonged periods while making adjustments. Damage to the engine can occur. Make a test cut. Based on performance of the saw while cutting, adjust the high speed mixture setting in 1/16-turn increments as follows:

- Clockwise until saw has good power in the cut with no hesitation. Do not adjust by sound or speed, but judge by how well the saw performs in the cut.
- Counterclockwise if the saw has speed, but dies in the cut or lacks power in the cut.

After completing adjustments, check for acceleration and chain movement at idle. Reset if necessary.

### Acceleration Check

If the engine dies or hesitates instead of accelerating, turn the low speed mixture adjustment counterclockwise until you have smooth acceleration with no chain movement at idle. Recheck and adjust as necessary for acceptable performance.

## STORAGE

Prepare your unit for storage at the end of the season or if it will not be used for 30 days or more.

### WARNING:

- Allow the engine to cool, and secure the unit before storing or transporting.
- Store chain saw and fuel in a well ventilated area where fuel vapors cannot reach sparks or open flames from water heaters, electric motors or switches, furnaces, etc.
- Store chain saw with all guards in place and position chain saw so that any sharp object cannot accidentally cause injury.
- Store chain saw well out of the reach of children.

### EXTERNAL SURFACES

If your chain saw is to be stored for a period of time, clean it thoroughly before storage. Store in a clean dry area.

- Lightly oil external metal surfaces and guide bar.
- Oil the chain and wrap it in heavy paper or cloth.

### FUEL SYSTEM

Under Fueling Engine in the Operating Section of this manual, see message labeled **IMPORTANT** regarding the use of gasohol in your chain saw.

Fuel stabilizer is an acceptable alterna-

five in minimizing the formation of fuel gum deposits during storage. Add stabilizer to the gasoline in the fuel tank or fuel storage container. Follow the mix instructions found on stabilizer containers. Run engine at least 5 minutes after adding stabilizer.

CRAFTSMAN 40:1, 2-cycle engine oil (air cooled) is especially blended with fuel stabilizer. If you do not use this Sears oil, you can add a fuel stabilizer to your fuel tank.

### ENGINE

- Remove spark plug and pour 1 teaspoon of 40:1, 2-cycle engine oil (air cooled) through the spark plug opening. Slowly pull the starter rope 8 to 10 times to distribute oil.
- Replace spark plug with new one of recommended type and heat range.
- Clean air filter.
- Check entire unit for loose screws, nuts, and bolts. Replace any damaged, broken, or worn parts.
- At the beginning of the next season, use only fresh fuel having the proper gasoline to oil ratio.

### OTHER

- Do not store gasoline from one season to another.
- Replace your gasoline can if it starts to rust.

### TROUBLE SHOOTING CHART

TROUBLE	CAUSE	REMEDY
Engine will not start or will run only a few seconds after starting.	<ul style="list-style-type: none"> <li>• Ignition switch off.</li> <li>• Engine flooded.</li> <li>• Fuel tank empty.</li> <li>• Spark plug not firing.</li> <li>• Fuel not reaching carburetor.</li> <li>• Carburetor requires adjustment.</li> <li>• None of the above.</li> </ul>	<ul style="list-style-type: none"> <li>• Move Ignition switch to ON.</li> <li>• See "Starting Instructions."</li> <li>• Fill tank with correct fuel mixture.</li> <li>• Install new spark plug.</li> <li>• Check for dirty fuel filter; replace. Check for kinked or split fuel line; repair or replace.</li> <li>• See "Carburetor Adjustments."</li> <li>• Contact Sears Service.</li> </ul>
Engine will not idle properly.	<ul style="list-style-type: none"> <li>• Idle speed set too high or too low.</li> <li>• Low Speed Mixture requires adjustment.</li> <li>• Crankshaft seals worn.</li> <li>• Compression low.</li> <li>• None of the above.</li> </ul>	<ul style="list-style-type: none"> <li>• See "Carburetor Adjustments."</li> <li>• See "Carburetor Adjustments."</li> <li>• Contact Sears Service.</li> <li>• Contact Sears Service.</li> <li>• Contact Sears Service.</li> </ul>
Engine will not accelerate, lacks power, or dies under a load.	<ul style="list-style-type: none"> <li>• Air filter dirty.</li> <li>• Spark plug fouled.</li> <li>• Carburetor requires adjustment.</li> <li>• Exhaust ports or muffler outlets plugged.</li> <li>• Compression low.</li> <li>• None of the above.</li> </ul>	<ul style="list-style-type: none"> <li>• Clean or replace air filter.</li> <li>• Clean or replace plug and regap.</li> <li>• See "Carburetor Adjustments."</li> <li>• Contact Sears Service.</li> <li>• Contact Sears Service.</li> <li>• Contact Sears Service.</li> </ul>
Engine smokes excessively.	<ul style="list-style-type: none"> <li>• Choke partially on.</li> <li>• Fuel mixture incorrect.</li> <li>• Air filter dirty.</li> <li>• High Speed Mixture requires adjustment.</li> <li>• Crankcase leak.</li> </ul>	<ul style="list-style-type: none"> <li>• Adjust choke.</li> <li>• Empty fuel tank and refill with correct fuel mixture.</li> <li>• Clean or replace air filter.</li> <li>• See "Carburetor Adjustments."</li> <li>• Contact Sears Service.</li> </ul>
Engine runs hot.	<ul style="list-style-type: none"> <li>• Fuel mixture incorrect.</li> <li>• Spark plug incorrect.</li> <li>• High Speed Mixture set too lean.</li> <li>• Exhaust ports or muffler outlets plugged.</li> <li>• Carbon build-up on muffler outlet screen.</li> <li>• Fan housing/cylinder fins dirty.</li> <li>• None of the above.</li> </ul>	<ul style="list-style-type: none"> <li>• See "Fueling Your Unit."</li> <li>• Replace with correct plug.</li> <li>• See "Carburetor Adjustments."</li> <li>• Contact Sears Service.</li> <li>• Clean spark arrestor screen.</li> <li>• Clean area.</li> <li>• Contact Sears Service.</li> </ul>
Oil inadequate for bar and chain lubrication.	<ul style="list-style-type: none"> <li>• Oil tank empty.</li> <li>• Oil pump or oil filter clogged.</li> <li>• Guide bar oil hole blocked.</li> </ul>	<ul style="list-style-type: none"> <li>• Fill oil tank.</li> <li>• Contact Sears Service.</li> <li>• Remove bar and clean.</li> </ul>



## TROUBLE SHOOTING CHART – Continued

TROUBLE	CAUSE	REMEDY
Chain moves at idle speed.	<ul style="list-style-type: none"> <li>• Idle speed requires adjustment.</li> <li>• Clutch requires repair.</li> </ul>	<ul style="list-style-type: none"> <li>• See "Carburetor Adjustments."</li> <li>• Contact Sears Service.</li> </ul>
Chain does not move when engine is accelerated.	<ul style="list-style-type: none"> <li>• Chain tension too tight.</li> <li>• Carburetor requires adjustment.</li> <li>• Guide bar rails pinched.</li> <li>• Clutch slipping.</li> </ul>	<ul style="list-style-type: none"> <li>• See "Chain Tension."</li> <li>• See "Carburetor Adjustments."</li> <li>• Repair or replace.</li> <li>• Contact Sears Service.</li> </ul>
Chain clatters or cuts roughly.	<ul style="list-style-type: none"> <li>• Chain tension incorrect.</li> <li>• Cutters damaged.</li> <li>• Chain worn.</li> <li>• Cutters dull, improperly sharpened, or depth gauges too high.</li> <li>• Sprocket worn.</li> <li>• Chain installed backwards.</li> </ul>	<ul style="list-style-type: none"> <li>• See "Chain Tension."</li> <li>• Contact Sears Service.</li> <li>• Resharpen or replace chain.</li> <li>• See "Sharpening Chain."</li> <li>• Contact Sears Service.</li> <li>• Install chain in right direction.</li> </ul>
Chain stops within the cut.	<ul style="list-style-type: none"> <li>• Chain cutter tops not filed flat.</li> <li>• Guide bar burred or bent; rails uneven.</li> <li>• Clutch slipping</li> </ul>	<ul style="list-style-type: none"> <li>• See "Sharpening Chain."</li> <li>• Repair or replace guide bar.</li> <li>• Contact Sears Service.</li> </ul>
Chain cuts at an angle.	<ul style="list-style-type: none"> <li>• Cutters damaged on one side.</li> <li>• Chain dull on one side.</li> <li>• Guide bar bent or worn.</li> </ul>	<ul style="list-style-type: none"> <li>• See "Sharpening Chain."</li> <li>• See "Sharpening Chain."</li> <li>• Replace guide bar.</li> </ul>

If situations occur which are not covered in this manual, use care and good judgement. If you need assistance, contact Sears Service or the CUSTOMER ASSISTANCE HELPLINE at 1-800-235-5878.

# REPAIR PARTS

SEARS MODEL 358.352162

**WARNING**

All repairs, adjustments and maintenance not described in the Operator's Manual must be performed by qualified service personnel.

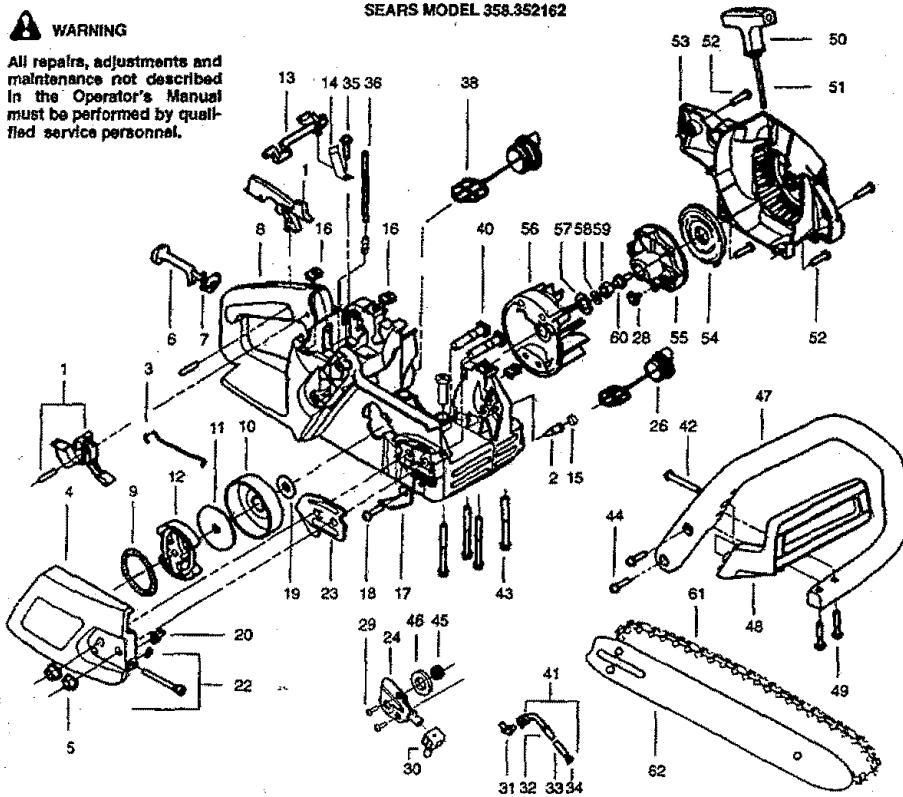

Ref.	Part No.	Description	Ref.	Part No.	Description	Ref.	Part No.	Description
1.	530069723	Trigger & Lockout Kit (Includes Pin)	24.	530069957	Oil Pump Kit (Incl. 28 & 31)	48.	530038224	Handguard
2.	530026119	Check Valve	26.	530010846	Oil Cap Ass'y.	49.	530015940	Screw
3.	530037809	Wire - Throttle	28.	530016080	Screw	50.	530037485	Starter Handle
4.	530037803	Clutch Cover	29.	530016064	Screw	51.	530069232	Rope Kit
5.	530015917	Nut - Bar Mounting	30.	530019206	Seal Block	52.	530015892	Screw
6.	530047989	Choke Lever	31.	530045477	Elbow-Oil Pickup	53.	530049336	Fan Housing
7.	530038406	Grommet-Choke Knob	32.	530038373	Pick-Up Oiler	54.	530027531	Recoil Spring
8.	530069803	Chassis Kit	33.	530037821	Oil Filter	55.	530037817	Starter Pulley
9.	530094188	Clutch Spring	34.	530030189	Plug- Oil Filter	56.	530038209	Flywheel Ass'y.
10.	530047061	Clutch Drum Ass'y - w/Brg.	35.	530015775	Screw	57.	530400897	Washer
11.	530015611	Washer - Clutch	36.	530069247	Fuel Line Kit (Large Dia.)	58.	530001717	Lockwasher
12.	530014949	Clutch Ass'y.	38.	530047192	Fuel Cap Ass'y. w/Retainer	59.	530016134	Nut-Flywheel
13.	530038227	Switch Lever	40.	530016133	Bolt - Bar	60.	530015920	Screw
14.	530016149	Switch Spring	41.	530047663	Oil-Pickup Ass'y. (Incl. 32, 33 & 34)	61.	71-3629	Chain - 16"
15.	530038264	Plug-Bronze Vent	42.	530018020	Screw	62.	71-36366	Bar - 16"
16.	530015922	Nut	43.	530016132	Bolt	Not Shown		
17.	530029850	Chain Catcher	44.	530015814	Screw	530087304	Operator Manual	
18.	530015814	Screw	45.	530037820	Worm Gear Spring	530052362	Decal-Chain Readjust	
19.	530015807	Washer - Thrust	46.	530019231	Dust Seal	530038486	Decal-Stop	
20.	530015826	Pin - Bar Adjusting	47.	530037799	Front Handle	530038891	Decal-Clutch Cover	
22.	530069611	Bar Adjusting Screw Kit				530047588	Decal-Fan Hsg.	
23.	530038238	Bar Mounting Plate				530049246	Decal-Starting Inst.	



# REPAIR PARTS

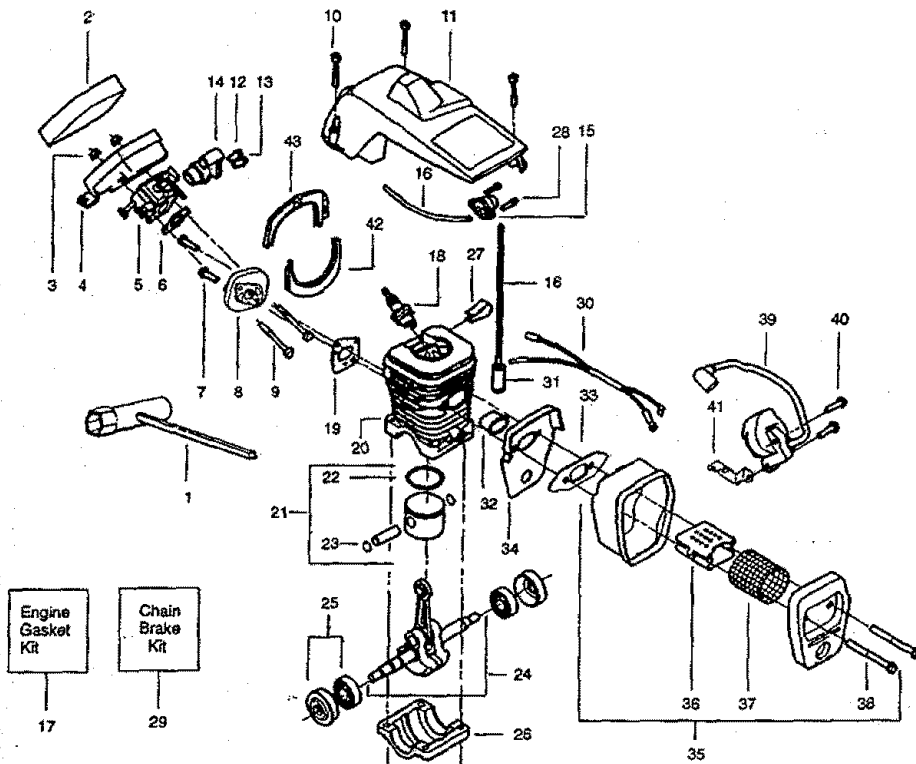

Ref.	Part No.	Description	Ref.	Part No.	Description
1.	530031163	Bar Wrench	22.	530029805	Piston Ring
2.	530037793	Foam-Air Filter	23.	530015697	Retainer
3.	530016101	Nut	24.	530047062	Crankshaft Ass'y.
4.	530037804	Air Filter Housing	25.	530047827	Seal & Bearing Ass'y.
5.	530069703	Carburetor Kit (Incl. 12 & 13)	26.	530037935	Cap-Crankcase
6.	530019239	Carb. Gasket	27.	530016138	Clip-High Tension Lead
7.	530015810	Screw	28.	530015780	Screw
8.	530049700	Carb. Adapter	29.	952706606	Chain Brake Kit
9.	530016187	Screw	30.	530052296	Wire Harness Ass'y.
10.	530016102	Screw	31.	530014362	Fuel Pickup Ass'y.
11.	530053184	Cylinder Shield	32.	530037652	Heat Insulator
12.	530038318	Limiter Cap-High	33.	530019221	Muffler Gasket
13.	530038317	Limiter Cap-Low	34.	530049870	Muffler Back Plate
14.	530049244	Grommet-Carb. Adjust	35.	530047207	Muffler Ass'y. (Incl. 33-34 & 36-38)
15.	530047566	Air Purge Ass'y.	36.	530037813	Muffler Diffuser
16.	530069216	Primer Line Kit (Small Dia)	37.	530036103	Spark Arrestor Screen
17.	530069608	Engine Gasket Kit (Incl. 6, 17, 19 & 33)	38.	530016132	Screw
18.	71-85849	Spark Plug (CJ-7Y)	39.	530039167	Ignition Module
19.	530019249	Gasket	40.	530015814	Screw
20.	530069931	Cylinder Kit	41.	530047442	Ground Strap
21.	530069604	Piston Kit (Incl. 22 & 23)	42.	530049714	Seal-Carb. Adapter (Lower)
			43.	530049715	Seal-Carb. Adapter (Upper)