

**KitchenAid**<sup>®</sup>  
PRO LINE™ SERIES

MODEL  
**KPFP850**  
FOOD PROCESSOR

**Introduction  
Section Contents**

Table of Contents .....	3
Food Processor Safety .....	5
Important Safeguards .....	6
Proof of Purchase & Registration .....	7
Electrical Requirements .....	8

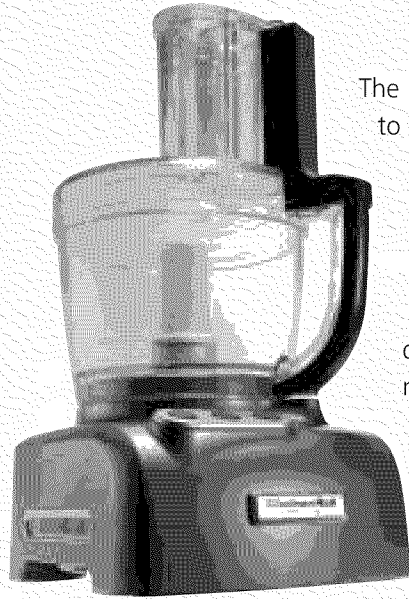

The **KitchenAid® PRO LINE™ Series Food Processor** is engineered to provide commercial quality performance. A professional 16-cup work bowl and extra-wide feed tube sit atop a rugged die-cast metal base. The powerful 1000-watt motor is designed to make quick work of the most demanding food preparation tasks. The heavy-gauge cutting blades and discs are made from the highest quality stainless steel for exceptionally clean slicing and shredding. This machine doesn't trade performance for capacity – you'll achieve extraordinary results no matter what the task.

The outstanding performance is matched by exceptional convenience. A mini bowl and mini blade transform the PRO LINE™ Series food processor into a mini-chopper, the perfect tool for finely chopping herbs, nuts, onions, and garlic. The Ultra Wide Mouth™ Feed Tube is one of the industry's largest – it will process tomatoes, cucumbers, and potatoes with a minimum of sectioning or slicing. Another great timesaver is the 13-cup chef's bowl: place it inside the work bowl, and you'll be able to slice or shred an item while keeping the work bowl clean for another ingredient.

The KitchenAid® PRO LINE™ Series: professional quality for the discriminating home chef. From the company distinguished by its legendary craftsmanship.

# TABLE OF CONTENTS

## INTRODUCTION

Introduction .....	2
Food Processor Safety .....	5
Important Safeguards .....	6
Proof of Purchase & Product Registration .....	7
Electrical Requirements .....	8

## FEATURES AND OPERATION

Food Processor Features .....	10
Preparing the Food Processor for Use	
Before First Use .....	12
Work Bowl Assembly .....	12
Multipurpose Blade & Dough Blade Assembly .....	13
Slicing & Shredding Disc Assembly .....	14
Mini Bowl Assembly .....	14
Chef's Bowl Assembly .....	15
Egg Whip Assembly & Use .....	15
Using the Food Processor	
Before Use .....	17
Food Pusher Interlock .....	17
Maximum Liquid Level .....	17
Turning the Food Processor On and Off .....	18
Using the Pulse Control .....	18
2-Piece Food Pusher .....	18
Disassembling the Food Processor .....	19
Care and Cleaning .....	21
Troubleshooting .....	22

## FOOD PROCESSING TIPS AND RECIPES

Using the Multipurpose Blade .....	24
Using a Slicing or Shredding Disc .....	26
Using the Dough Blade .....	27
Using the Egg Whip .....	28
Helpful Hints .....	29
Appetizer Recipes	
Preparation and Serving Suggestions .....	34
Crab-Stuffed Mushrooms .....	35
Sesame-Almond Crackers .....	36
Caramelized Onion Puff Pastry Squares .....	37
Hot Artichoke Dip .....	38
Camembert Salmon Dip .....	39
Chipotle Deviled Eggs .....	40
Tropical Fruit Salsa .....	41
Shrimp Dill Dip .....	42
Roasted Salsa Verde .....	43
Salad & Dressing Recipes	
White Balsamic Vinaigrette .....	44
Mediterranean Hot Chicken Salad .....	45
Citrus Dressing .....	46
Fresh Jicama Salad .....	47
Chicken Wild Rice Salad .....	48
Asian Coleslaw For A Crowd .....	49
Hot Potato Salad .....	50
Broccoli-Kohlrabi Confetti Salad .....	51

# TABLE OF CONTENTS

## Soup & Sandwich Recipes

Cheddar Broccoli Soup .....	52
Chicken Chutney Sandwich Spread .....	53
Roasted Butternut Squash Soup With Herb Pistou .....	54
Runza Pocket Sandwiches .....	55
Pan-Fried Veggie Burgers .....	56
Winter Vegetable Soup .....	57
Muffaletta Sandwiches .....	59
French Onion Soup .....	60
Creole Gumbo .....	61

## Vegetable & Side Dish Recipes

Sweet Dilled Cucumbers and Onions .....	63
Layered Eggplant and Pepper Casserole .....	64
Spring Mix Basmati Rice .....	65
Bourboned Carrots .....	66
Loaded Baked Potato Casserole .....	67

## Main Dish Recipes

Szechwan Pork .....	68
Chicken Fajitas .....	69
Individual Pizzas .....	70
Layered Eggplant and Roasted Red Pepper Casserole .....	72
Herbed Salmon Patties with Cilantro-Caper Mayonnaise .....	73
Chicken Satay with Peanut Sauce .....	74

## Bread Recipes

Wheat Boules .....	75
Sunday Dinner Rolls .....	76
White Bread .....	78
Cranberry-Walnut Scones .....	80
Baking Powder Biscuits .....	81

## Dessert Recipes

Individual Cranberry Pear Crisps .....	82
Velvety Sour Cream Cheesecake .....	83
Fresh Fruit Tart .....	84
Apple Pie .....	86
Pastry Crust .....	87
3-Layer Carrot Cake with Cream Cheese Frosting .....	88
Tropical Lemon Meringue Pie .....	90
Chocolate-Orange Mousse .....	91
Pecan Shortbread Bars .....	92

## WARRANTY AND SERVICE INFORMATION

Warranty for the 50 United States & District of Columbia .....	94
Warranty for Puerto Rico .....	95
Arranging for Hassle-Free Replacement .....	95
Ordering Accessories & Replacement Parts .....	96
Arranging for Service After the Warranty Expires .....	96
Arranging for Service Outside the 50 United States & Puerto Rico .....	97

# FOOD PROCESSOR SAFETY

## Your safety and the safety of others are very important.

We have provided many important safety messages in this manual and on your appliance. Always read and obey all safety messages.



This is the safety alert symbol.

This symbol alerts you to potential hazards that can kill or hurt you and others.

All safety messages will follow the safety alert symbol and either the word "DANGER" or "WARNING." These words mean:



**You can be killed or seriously injured if you don't immediately follow instructions.**



**You can be killed or seriously injured if you don't follow instructions.**

All safety messages will tell you what the potential hazard is, tell you how to reduce the chance of injury, and tell you what can happen if the instructions are not followed.

# IMPORTANT SAFEGUARDS

When using electrical appliances, basic safety precautions should always be followed, including the following:

1. Read all instructions and information in this instruction book and any other literature included in this packaging referring to this product before operating or using this appliance.
2. To protect against risk of electrical shock, do not put Food Processor in water or other liquids.
3. Close supervision is necessary when any appliance is used by or near children.
4. Unplug from the outlet when not in use, before putting on or taking off parts, and before cleaning.
5. Avoid contacting moving parts.
6. Do not operate any appliance with a damaged cord or plug, or after the appliance malfunctions or is dropped or damaged in any manner. Return appliance to the nearest Authorized Service Center for examination, repair, or electrical or mechanical adjustment.
7. The use of attachments not recommended or sold by the manufacturer may cause fire, electric shock, or injury.
8. Do not use outdoors.
9. Do not let cord hang over edge of table or counter.
10. Keep hands and utensils away from moving blades or discs while processing food to reduce the risk of severe injury to persons or damage to the Food Processor. A scraper may be used, but must be used only when the Food Processor is not running.
11. Blades are sharp. Handle carefully.
12. To reduce the risk of injury, never place cutting blade or discs on base without first putting bowl properly in place.
13. Be certain cover is securely locked in place before operating appliance.
14. Never feed food by hand. Always use food pusher.
15. Do not attempt to defeat the cover interlock mechanism.
16. This product is designed for household use only.

SAVE THESE INSTRUCTIONS

# PROOF OF PURCHASE

## & PRODUCT REGISTRATION

Always keep a copy of the sales receipt showing the date of purchase of your Food Processor. Proof of purchase will assure you of in-warranty service.

Before you use your Food Processor, please fill out and mail your product registration card packed with the unit. This card will enable us to contact you in the unlikely event of a product safety notification and assist us in complying with the provisions of the Consumer Product Safety Act. This card does not verify your warranty.

Please complete the following for your personal records:

Model Number: KFPF850

Serial Number \_\_\_\_\_

Date Purchased \_\_\_\_\_

Store Name \_\_\_\_\_

# ELECTRICAL REQUIREMENTS

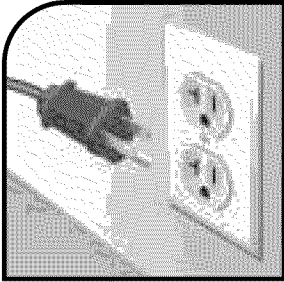

**Volts: 120 V.A.C. only.**

**Hertz: 60 Hz**

**NOTE:** This Food Processor has a 3 prong grounded plug. To reduce the risk of electrical shock, this plug will fit in an outlet only one way. If the plug does not fit in the outlet, contact a

qualified electrician. Do not modify the plug in any way.

A short power-supply cord is provided to reduce the risk resulting from becoming entangled in or tripping over a longer cord. Do not use an extension cord. If the power supply cord is too short, have a qualified electrician or serviceman install an outlet near the appliance.

## **⚠ WARNING**



### **Electrical Shock Hazard**

**Plug into a grounded 3 prong outlet.**

**Do not remove ground prong.**

**Do not use an adapter.**

**Do not use an extension cord.**

**Failure to follow these instructions can result in death, fire, or electrical shock.**

**KitchenAid®**  
PRO LINE™ SERIES

# FEATURES AND OPERATION

## Features and Operation Section Contents

Food Processor Features.....	10
Preparing for Use.....	12
Using the Food Processor.....	17
Disassembling the Food Processor.....	19
Care and Cleaning.....	21
Troubleshooting.....	22

# MODEL KPFP850 FOOD PROCESSOR FEATURES



Model KPFP850  
Food Processor

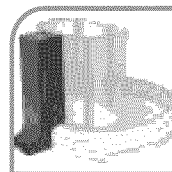

## Work Bowl Cover with Ultra Wide Mouth™ Feed Tube

One of the industry's largest feed tubes accommodates large items – like tomatoes, cucumbers, and potatoes – with a minimum of sectioning or slicing.

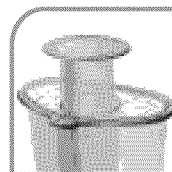

## 2-Piece Food Pusher

For smaller items, remove the small pusher from the central tube in the large pusher. The small pusher and feed tube make it easy to process herbs, nuts, single carrots and celery.

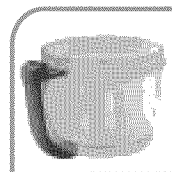

## 16-Cup Work Bowl

The tough, crystal-clear polycarbonate bowl provides capacity for the largest jobs. The bowl features a comfortable handle.

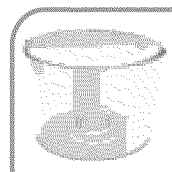

## Chef's Bowl

Place the 13-cup Chef's Bowl inside the Work Bowl, and slice or shred a food item while keeping the Work Bowl clean for another ingredient.

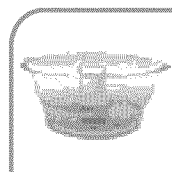

## Mini Bowl and Mini Blade

Bowl and blade are perfect for small chopping and mixing jobs. The 4½-cup bowl holds more than most standalone choppers. The mini blade is made of high quality stainless steel.

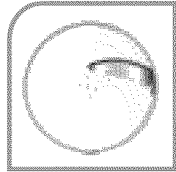

#### **Fine (2 mm) Slicing Disc**

Disc produces approximately  $\frac{1}{16}$ -inch slices of most foods, from delicate strawberries to partially frozen meats.

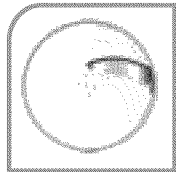

#### **Medium (4 mm) Slicing Disc**

Disc produces approximately  $\frac{1}{8}$ -inch slices of most foods.

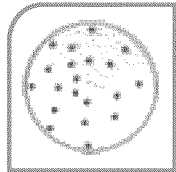

#### **Medium (4 mm) Shredding Disc**

Disc produces approximately  $\frac{1}{8}$ -inch shreds of most firm fruits, vegetables, and cheese.

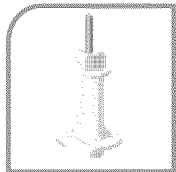

#### **Disc Stem**

Stem fits over the power shaft on the base and into the bottom of a slicing or shredding disc.

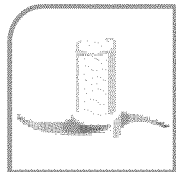

#### **Stainless Steel Multipurpose Blade**

Versatile blade chops, minces, blends, mixes, and emulsifies in a matter of seconds.

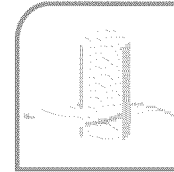

#### **Dough Blade**

The dough blade is specially designed for mixing and kneading yeast dough.

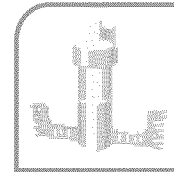

#### **Egg Whip**

The egg whip will quickly whip cream and egg whites for soft meringues, mousses, soufflés, and desserts.

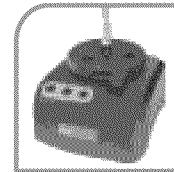

#### **Die-Cast Metal Base**

The base features the on, off, and pulse buttons along with the power shaft, which rotates the blades and discs.

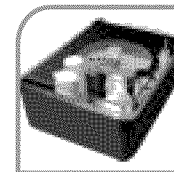

#### **Chef's Accessory Case**

Case helps protect blades, discs, and other accessories while keeping them organized and ready for use.

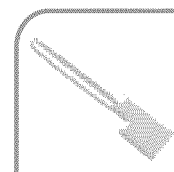

#### **Spatula**

Special shape facilitates food removal from bowls, discs, and blades.

# PREPARING THE FOOD PROCESSOR FOR USE

## Before First Use

Before using your food processor for the first time, wash the work bowl, work bowl cover, chef's bowl, mini bowl, feed tube pusher, discs, and blades either by hand or in the dishwasher (see "Care and Cleaning" on page 21).

## Work Bowl Assembly

1. Place the food processor base on a dry, level countertop with the controls facing forward. Do not plug in the unit until it is completely assembled.
2. With the handle just to the left of center, place the work bowl on the base, fitting the center opening over the power shaft.
3. Grasp the work bowl handle and turn the bowl to the right until it locks into position.



**⚠ WARNING**

**Cut Hazard**

**Handle blades carefully.**

**Failure to do so can result in cuts.**

4. Insert the desired accessory into the work bowl. See pages 13–16 for accessory instructions.
5. Place the work bowl cover on the work bowl with the feed tube just to the left of the work bowl handle. Grasp the feed tube and turn the cover to the right until it locks into place.

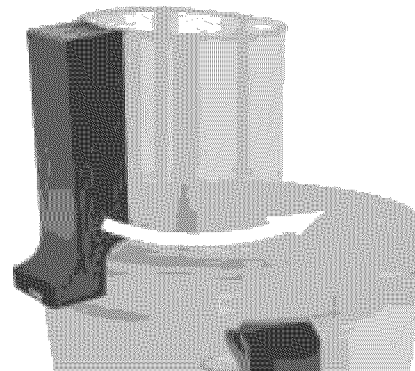

**NOTE:** Do not attach the cover to the work bowl before the work bowl is locked on the base. Damage to the work bowl may result.

6. Fit the pusher into the feed tube.

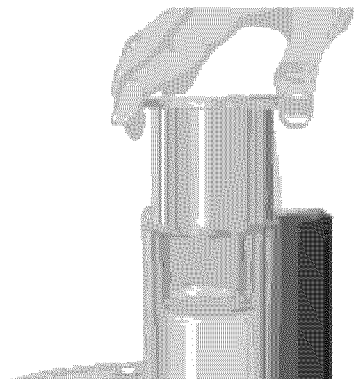

## **⚠ WARNING**



### **Electrical Shock Hazard**

**Plug into a grounded 3 prong outlet.**

**Do not remove ground prong.**

**Do not use an adapter.**

**Do not use an extension cord.**

**Failure to follow these instructions can result in death, fire, or electrical shock.**

7. Plug the food processor into a 3 prong grounded outlet.

**NOTE:** Your PRO LINE™ Series Food Processor will not operate unless the work bowl and work bowl cover are properly locked on the base, and the pusher is inserted to the maximum fill line on the feed tube.

Do not remove the work bowl from the base without first removing the work bowl cover. Damage to the work bowl may result.

### **Multipurpose Blade and Dough Blade Assembly**

Place the blade on the power shaft. Rotate the blade so it falls into place on the shaft.

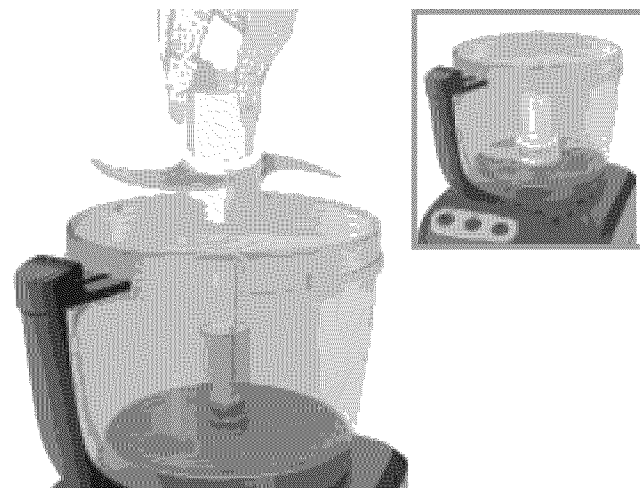

Continued...

# PREPARING THE FOOD PROCESSOR FOR USE

## Slicing and Shredding Disc Assembly

Place the disc stem on the power shaft. Fit the disc over the metal pin on the disc stem, then rotate the disc until it falls fully onto the stem.



## Mini Bowl Assembly

Place the mini bowl inside the work bowl over the power shaft. Rotate the mini bowl until it falls into place. When properly seated in the work bowl, the mini bowl cannot be rotated. Fit the mini blade on the power shaft. It may be necessary to rotate the blade until it falls into place.

The mini bowl can also be placed in the chef's bowl in a similar manner.

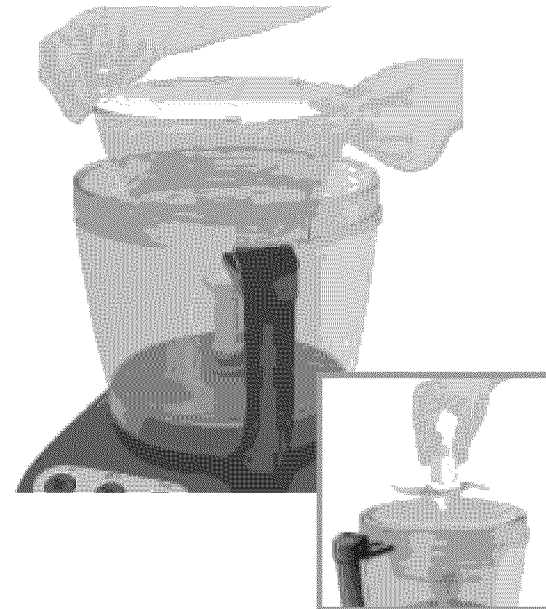

To remove the mini bowl after processing, lift the bowl using the two finger grips located along the top edge of the bowl.



### Chef's Bowl Assembly

Place the chef's bowl inside the work bowl over the power shaft. Rotate the chef's bowl until it falls into place. When properly seated in the work bowl, the chef's bowl cannot be rotated.

The chef's bowl can only be used with the slicing and shredding discs – the multipurpose blade cannot be used.

To remove the chef's bowl after processing, lift the bowl using the two finger grips located along the top edge of the bowl.

### Egg Whip Assembly and Use

The egg whip is designed to whip egg whites or heavy cream to create toppings or soft meringues. For the best results when whipping cream, use at least 1 cup of cream and no more than 2 cups at most. When whipping egg whites, use a minimum of 4 – smaller quantities may not whip to maximum volume.

#### To assemble:

The egg whip consists of 4 pieces – the egg whip stem, stem cover, whip paddle, and cap.

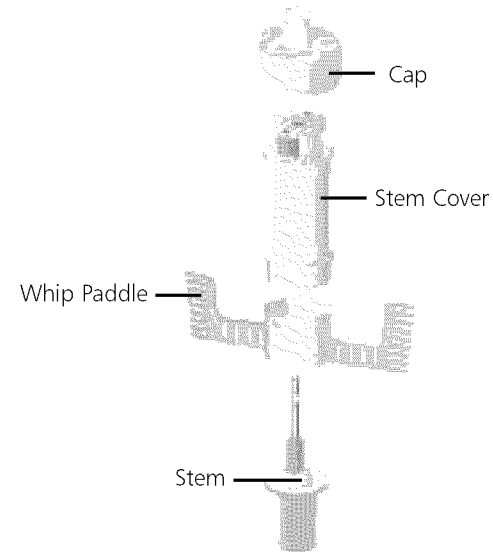

Continued...

# PREPARING THE FOOD PROCESSOR FOR USE

1. Place the egg-whip stem on the power shaft. Slowly turn the stem until it drops fully onto the shaft.
2. Align the L-shaped notch on the whip paddle with the small post on the stem cover, and slide the paddle onto the cover. Turn slightly to lock paddle.
3. Fit the stem cover and paddle over the egg whip stem. Push downward to engage the ridges of the stem with the gears of the paddle.
4. Fit the egg whip cap over the egg whip stem. Push downward to lock it into place.
5. Place the work bowl cover on the work bowl with the feed tube just to the left of the handle. Make sure the center pin of the egg whip fits into the center opening of the cover. Grasp the feed tube and turn the cover to the right to lock it into place. Insert the pusher into the feed tube. The egg whip is now ready to operate.
6. Press the On Button and whip ingredients to the desired texture and volume. Press the Off Button when finished.

## **To disassemble:**

1. Unplug the base from the electrical outlet. Remove the work bowl cover with a clockwise turn.
2. Lift the egg whip assembly off the power shaft. Remove whipped ingredients from the work bowl.
3. Pull the cap from the egg whip assembly. Push downward on the stem pin to remove stem from the stem cover. Turn the egg whip paddle to unlock, and slide the paddle from the stem cover.

# USING THE PRO LINE™ SERIES FOOD PROCESSOR

## **⚠ WARNING**



### **Rotating Blade Hazard**

**Always use food pusher.**

**Keep fingers out of openings.**

**Keep away from children.**

**Failure to do so can result in amputation or cuts.**

## **Before Use**

Before operating the food processor, be sure the work bowl, blades, and work bowl cover are properly assembled on the food processor base (see “Preparing the Food Processor for Use” starting on page 12).

## **Food Pusher Interlock**

The food pusher is part of the safety interlock system. The food processor will not run unless the pusher is inserted to the maximum fill line on the feed tube.

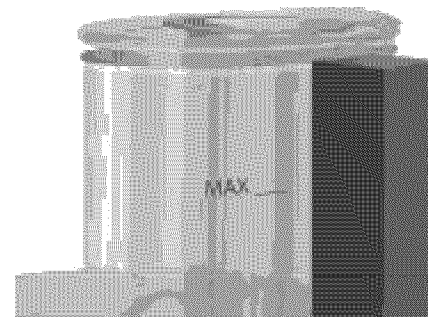

## **Maximum Liquid Level**

This line on the work bowl indicates the maximum level of liquid that can be processed by the food processor.

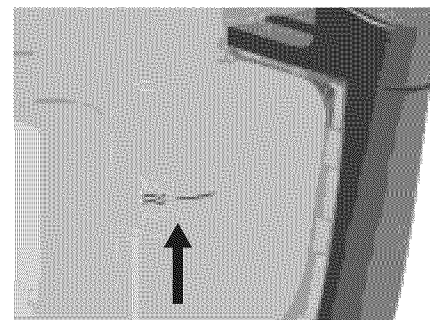

# USING THE PRO LINE™ SERIES FOOD PROCESSOR

## Turning the Food Processor On and Off

1. To turn on the food processor, press the On Button. The unit will run continuously and the blue indicator light will glow.

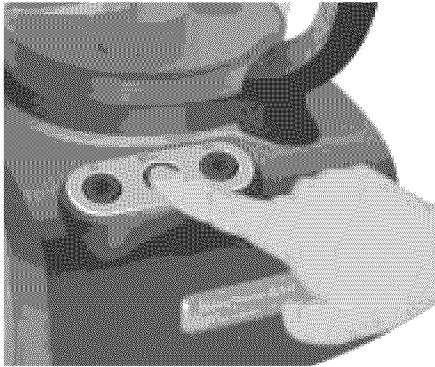

2. To stop the food processor, press the Off Button. The blue indicator light will go out and an automatic brake will stop the action of the blade or disk within seconds.
3. Wait until the blade or disk comes to a complete stop before removing the work bowl cover. Be sure to turn off the food processor before removing the work bowl cover, or before unplugging the unit.

**NOTE:** If the unit fails to operate, make sure the work bowl and cover are properly locked on the base, and the food pusher is inserted to the maximum fill line on the feed tube (see "Preparing the Food Processor for Use" starting on page 12).

## Using the Pulse Control

The pulse control allows precise control of the duration and frequency of processing. It's great for jobs which require a light touch. Just press and hold the Pulse Button to start processing, and release it to stop. The blue indicator light will glow each time the Pulse Button is pressed.

## 2-Piece Food Pusher

To slice or shred small items, insert the 2-piece food pusher into the feed tube, then turn the small center pusher clockwise to unlock and remove. Use the center feed tube and pusher to process small or slender items, or to add liquid while the food processor is running. When not using the small feed tube, lock the small pusher into place by turning it counter-clockwise.

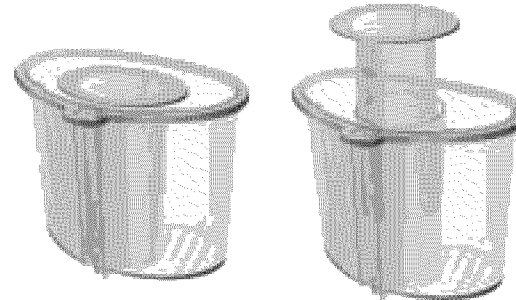

# DISASSEMBLING THE FOOD PROCESSOR

## **! WARNING**

### **Cut Hazard**

**Handle blades carefully.**

**Failure to do so can result in cuts.**

**NOTE:** If you have difficulty removing the pusher from the feed tube, it is likely that food particles have become lodged in the interlock system. To free the pusher, soak the work bowl cover in warm water or wash it in a dishwasher.

1. Turn the work bowl cover to the left and remove.

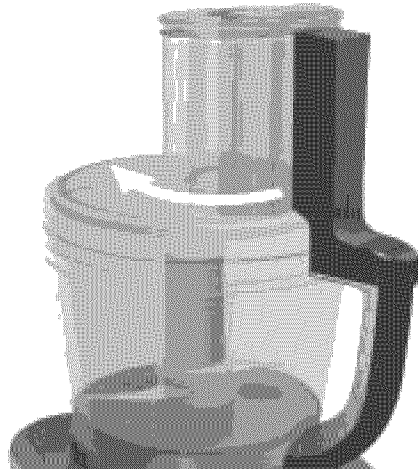

2. If using a disc, remove it before removing the bowl. Place two fingers under each side of the disc and lift it straight up. Remove the disc stem.

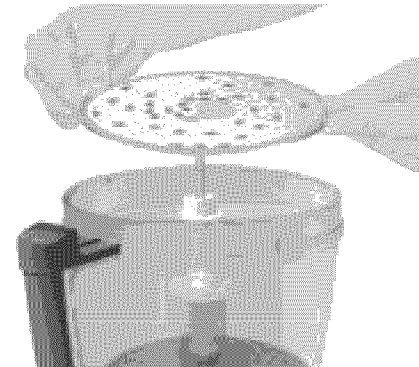

3. If using the mini bowl or chef's bowl, grasp and remove the bowl using the finger grips located along the top edge of the bowl.

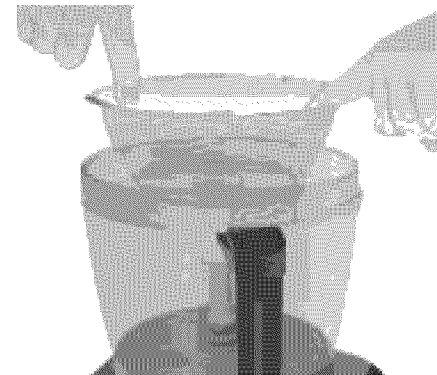

Continued...

# DISASSEMBLING THE FOOD PROCESSOR

4. Turn the work bowl to the left to unlock it from the base. Lift to remove.

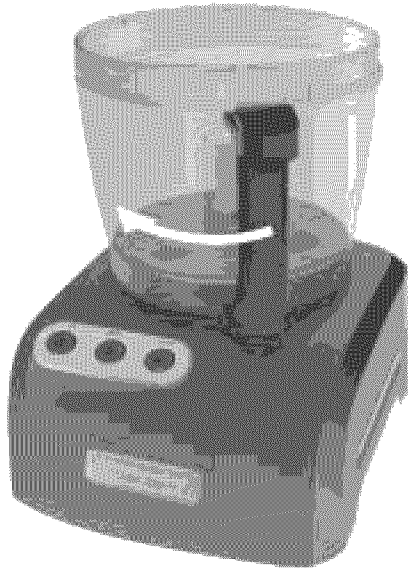

5. The multipurpose blade can be removed from the work bowl before the contents are emptied. The blade can also be held in place as you remove food: grasp the work bowl from the bottom and place one finger through the center opening to grip the blade shaft. Then remove food from the bowl and blade with a spatula.

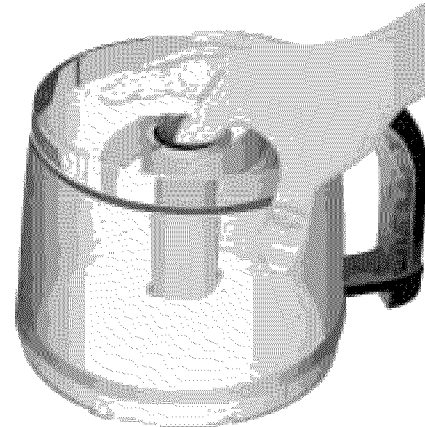

# CARE AND CLEANING

## **⚠ WARNING**

### **Cut Hazard**

**Handle blades carefully.**

**Failure to do so can result in cuts.**

**1** Press the Off Button and unplug the food processor before cleaning.

**2** Wipe the metal base with a warm, sudsy cloth and wipe clean with a damp cloth. Dry with a soft cloth. Do not use abrasive cleansers or scouring pads.

**NOTE:** Do not use sharp objects to clean around the control buttons; damage may result. Use a soft brush.

**3** All the other parts of the PRO LINE™ Series Food Processor are dishwasher safe. Be sure to load them away from exposed heating elements in the dishwasher. If washing the Food Processor parts by hand, avoid the use of abrasive cleansers or scouring pads—they may scratch or cloud the work bowl and cover. A long-handled dish brush will facilitate hand-cleaning. Thoroughly dry all parts after washing.

**4** Wipe cord with a warm, sudsy cloth; wipe cord clean with a damp cloth. Dry with a soft cloth.

**5** To prevent damage to the interlock system, always store the work bowl and work bowl cover in the unlocked position when not in use.

**6** Disassembled discs, shafts, and blades should be stored in the provided storage case, and in a location out of the reach of children.

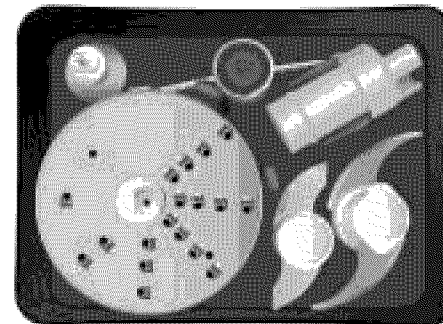
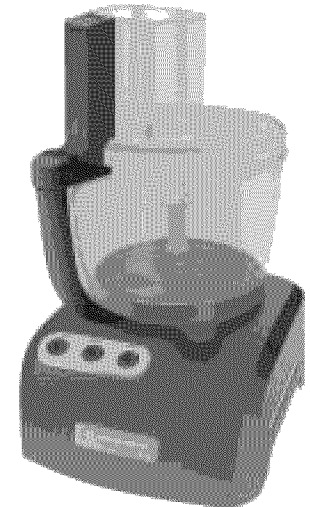

# TROUBLESHOOTING

- **If your food processor should fail to operate, check the following:**

- Make sure the work bowl and work bowl cover are properly locked on the base, and the food pusher is inserted to the maximum fill line on the feed tube.
- See if the food processor is plugged into a grounded 3 prong outlet. If it is, unplug the food processor, then plug it into the same outlet again. If the food processor still does not work, check the fuse or circuit breaker on the electrical circuit the food processor is connected to and make sure the circuit is closed.

- **If the food processor shuts off while it is running:**

- The food processor may be overheated. If the motor exceeds a certain temperature, it will automatically shut off to prevent damage. This should be an extremely rare occurrence. If it happens, press the Off Button and wait 15 minutes for the food processor to cool before resuming. If the food processor still refuses to run, wait an additional 15 minutes for the food processor to cool.

- **If you have difficulty removing the food pusher from the feed tube:**

- Food particles are probably lodged in the interlock system. To free the pusher, soak the work bowl cover in warm water or wash it in a dishwasher.

If the problem cannot be corrected with the steps in this section, see the KitchenAid Warranty and Service section on page 93\*.

\* Do not return the food processor to the retailer – they do not provide service.

**KitchenAid®**  
PRO LINE™ SERIES

# FOOD PROCESSING

## TIPS AND RECIPES

### Tips and Recipes Section Contents

Using the Multipurpose Blade.....	24
Using a Slicing or Shredding Disc.....	26
Using the Dough Blade.....	27
Using the Egg Whip.....	28
Helpful Hints.....	29
Recipes.....	33

# FOOD PROCESSING TIPS

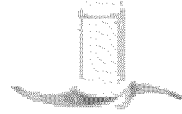

## Using the Multipurpose Blade

### To chop fresh fruits or vegetables:

Peel, core, and/or remove seeds. Cut food in 1 to 1½-inch pieces. Process food to desired size, using short pulses, 1 to 2 seconds each time. Scrape sides of bowl if necessary.

### To puree cooked fruits and vegetables (except potatoes):

Add ¼ cup liquid from recipe per cup of food. Process food, using short pulses, until finely chopped. Then process continuously until desired texture is achieved. Scrape sides of bowl if necessary.

### To prepare mashed potatoes:

Insert chef's bowl into the work bowl. Using the shredding disc, shred hot, cooked potatoes. Remove the chef's bowl with potatoes. Place multipurpose blade in work bowl, and add shredded potatoes, softened butter, milk, and seasonings. Pulse 3 to 4 times, 2 to 3 seconds each time, until milk is absorbed and texture is smooth. Do not overprocess.

### To chop dried (or sticky) fruits:

The fruit should be cold. Add ¼ cup of flour from recipe per ½ cup dried fruit. Applying short pulses, process fruit until desired texture is achieved.

### To finely chop citrus peel:

With a sharp knife, peel colored portion (without white membrane) from citrus. Cut peel into small strips. Process until finely chopped.



**To mince garlic, or to chop fresh herbs or small quantities of vegetables:**

With processor running, add food through the small feed tube. Process until chopped. For best results, make sure work bowl and ingredients are very dry before chopping garlic or fresh herbs.

**To chop nuts or make nut butters:**

Process up to 3 cups of nuts to desired texture, using short pulses, 1 to 2 seconds each time. For a coarser texture, process smaller batches, pulsing 1 or 2 times, 1 to 2 seconds each time. Pulse more often for finer texture. For nut butters, process continuously until smooth. Store in refrigerator.

**To chop cooked or raw meat, poultry, or seafood:**

The food should be very cold. Cut in 1-inch pieces. Process up to 2½ pounds at a time to desired size, using short pulses, 1 to 2 seconds each time. Scrape sides of bowl if necessary.

**To make bread, cookie, or cracker crumbs:**

Break food into 1½ to 2-inch pieces. Process until fine. For larger pieces, pulse 2 to 3 times, 1 to 2 seconds each time. Then process until fine.

**To melt chocolate:**

Combine chocolate and sugar from recipe in work bowl. Process until finely chopped. Heat liquid from recipe. With processor running, pour hot liquid through the small feed tube. Process until smooth.

**To grate hard cheeses, such as Parmesan and Romano:**

Never attempt to process cheese that cannot be pierced with the tip of a sharp knife. You can use the multipurpose blade to grate hard cheeses. Cut cheese in 1-inch pieces. Place in work bowl. Process, using short pulses, until coarsely chopped. Process continuously until finely grated.

Continued...

# FOOD PROCESSING TIPS



## Using a Slicing or a Shredding Disc

**NOTE:** When cutting and packing food items in the Ultra Wide Mouth™ feed tube, do not exceed the maximum fill line; this will permit the pusher to engage the interlock and the unit to operate.

### To cut julienne or match-stick strips of vegetables and fruits:

Cut food to fit feed tube horizontally. Position food horizontally in feed tube. Process, applying even pressure to make plank-like slices. Re-stack slices and position vertically or horizontally in feed tube. Process, applying even pressure.

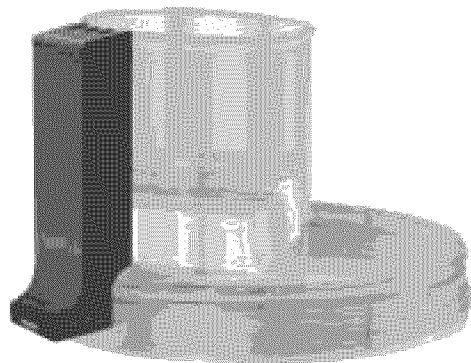

### To slice or shred fruits or vegetables that are long and relatively small in diameter, such as celery, carrots, and bananas:

Cut food to fit feed tube vertically or horizontally, and pack feed tube securely to keep food properly positioned. Process, applying even pressure. Or use the small feed tube in the two-piece food pusher. Position food vertically in the tube, and use the small food pusher to process the food.

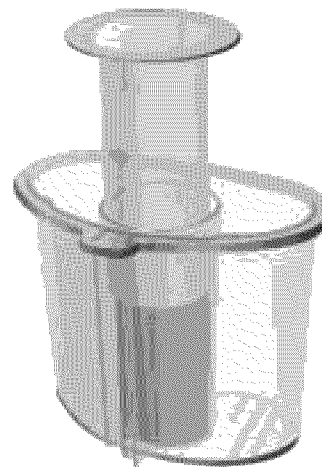

### To slice or shred fruits and vegetables that are round, such as onions, apples, and green peppers:

Peel, core, and/or remove seeds. Cut into halves or quarters to fit feed tube. Position in feed tube and process, applying even pressure.

**To slice or shred fruits and vegetables that are small, such as strawberries, mushrooms, and radishes:**

Position food vertically or horizontally in layers within the feed tube. Fill feed tube in order to keep food positioned properly, but do not exceed the maximum fill line. Process, applying even pressure. Or use the small feed tube in the two-piece food pusher. Position food vertically in the tube and use the small food pusher to process food.

**To shred spinach and other leaves:**

Stack leaves. Roll up stacked leaves and stand the rolls vertically in the feed tube. Process, applying even pressure.

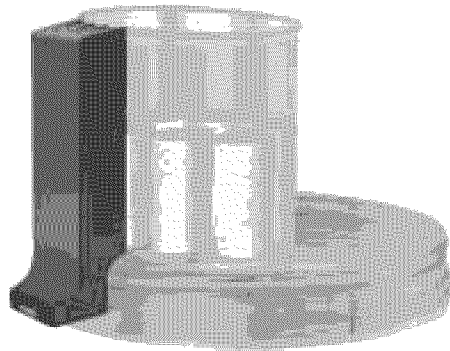

**To slice uncooked meat or poultry, such as stir-fry meats:**

Cut or roll food to fit feed tube. Wrap and freeze meat until it is solid to touch (30 minutes to 2 hours depending on thickness of meat). Make sure you can still pierce the meat with the tip of a sharp knife. If not, allow meat to thaw slightly. Process, applying even pressure.

**To slice cooked meat or poultry, including salami, pepperoni, etc.:**

Cooked meat should be very cold. Cut into pieces to fit feed tube. Process food, using firm, even pressure.

**To shred firm and soft cheeses:**

Firm cheese should be very cold. For best results with soft cheeses, such as mozzarella, freeze 10 to 15 minutes before processing. Cut to fit feed tube. Process, applying even pressure.



**Using the Dough Blade**

The dough blade is specially designed for mixing and kneading yeast dough quickly and thoroughly. For the best results, do not knead recipes that use more than 6 cups of all-purpose flour, or 4 cups of whole grain flour.

Continued...

# FOOD PROCESSING TIPS

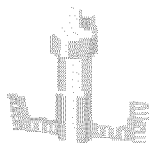

## Using the Egg Whip

### To make egg white meringue:

Place 4 egg whites and  $\frac{1}{4}$  teaspoon cream of tartar in work bowl fitted with the egg whip attachment. Process about 15 to 20 seconds, until foamy. With processor running, slowly add  $\frac{1}{4}$  to  $\frac{1}{2}$  cup of sugar through the small feed tube. Process until stiff peaks form, about 4 minutes. Stop processor as necessary to check texture of mixture.

### To whip cream:

Pour 1 cup heavy cream in work bowl fitted with egg whip attachment. Process 30 seconds. With processor running, add 2 tablespoons powdered sugar through the small feed tube. Process until soft peaks form, about 30 to 40 seconds. Stop processor as necessary to check texture of mixture. With processor running, add  $\frac{1}{2}$  teaspoon of vanilla, if desired, through the small feed tube. Process until mixed. Do not overprocess.

For the best results, never attempt to whip more than 2 cups of cream.

# HELPFUL HINTS

**1**

When cutting and packing food items in the Ultra Wide Mouth™ feed tube, do not exceed the maximum fill line. This will permit the pusher to engage the interlock and the unit to operate.

**2**

Organize processing tasks to minimize bowl cleanup. Process dry or firm ingredients before liquid ingredients.

**3**

After removing the work bowl cover, place it upside down on the counter. This will help keep the counter clean.

**4**

To easily clean ingredients from the multipurpose blade, just empty the work bowl, replace the lid, and pulse 1 to 2 seconds to spin the blade clean.

**5**

Do not overfill work bowl or mini bowl. For thin mixtures, fill work bowl up to  $\frac{1}{2}$  to  $\frac{2}{3}$  full. For thicker mixtures, fill work bowl up to  $\frac{3}{4}$  full. For liquids, fill to the maximum level as indicated on the work bowl (see “Maximum Liquid Level” on page 17). When chopping, the work bowl should be no more than  $\frac{1}{3}$  to  $\frac{1}{2}$  full. Use the mini bowl for up to 1 cup of liquid or  $\frac{1}{2}$  cup solids.

## HELPFUL HINTS

6

To capitalize on the speed of the processor, drop ingredients to be chopped through the small feed tube while the processor is running.

7

Position slicing discs so the cutting surface is just to the right of the feed tube. This allows the blade a full rotation before contacting food.

8

Different foods require varying degrees of pressure for best shredding and slicing results. In general, apply light pressure for soft, delicate foods (strawberries, tomatoes, etc.), moderate pressure for medium foods (zucchini, potatoes, etc.), and firmer pressure for harder foods (carrots, apples, hard cheeses, partially frozen meats, etc.).

9

Never process any food that is so hard or firmly frozen that it cannot be pierced with the tip of a sharp knife. Hard food can cause damage to the blade or motor. If a piece of hard food, such as carrot, becomes wedged or stuck on the blade, stop the processor and remove the blade. Using special care, remove food from the blade.

10

When preparing a cake or cookie batter or quick bread, use the multipurpose blade to cream fat and sugar first. Add dry ingredients last. Place nuts and fruit on top of flour mixture to prevent overchopping. Process nuts and fruits with short pulses until blended with other ingredients. Do not overprocess.

**11**

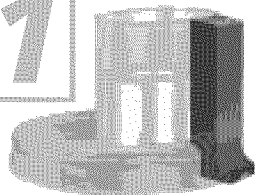

Sometimes slender foods, such as carrots or celery, fall over in the feed tube, resulting in an uneven slice. To minimize this, cut food in several pieces and pack the feed tube with the food. For processing small or slender items, the small feed tube in the two piece food pusher will prove especially convenient.

**12**

Soft and medium-hard cheese may spread out or roll up on the shredding disc. To avoid this, shred only chilled cheese.

**13**

When shredded or sliced food piles up on one side of the bowl, stop the processor and redistribute food using a spatula.

**14**

When food quantity reaches the bottom of a slicing or shredding disc, stop processing and remove the food.

**15**

A few larger pieces of food may remain on top of the disc after slicing or shredding. If desired, cut these by hand and add them to the mixture.

## HELPFUL HINTS

16

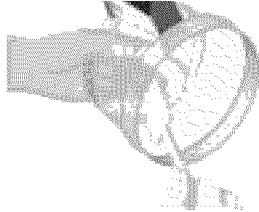

To remove the contents of the work bowl without removing the multipurpose blade, grasp the work bowl from the bottom and place one finger through the center opening to hold the blade in place. Then remove food from the bowl and blade with a spatula.

17

Your Food Processor isn't designed to perform the following functions:

- Grind coffee beans, grains, or hard spices.
- Grind bones or other inedible parts of food.
- Liquefy raw fruits or vegetables.
- Slice hard-cooked eggs or meats that have not been chilled.

18

If any plastic parts should discolor due to the types of food processed, simply clean with a light bleach solution, following directions on the bleach container.

**KitchenAid®**  
PRO LINE™ SERIES

# FOOD PROCESSOR RECIPES

## Food Processor Recipe Section Contents

Appetizer Serving Suggestions.....	34
Appetizers.....	35
Salad and Dressings.....	44
Soups and Sandwiches.....	52
Vegetables and Side Dishes.....	63
Main Dishes.....	68
Breads.....	75
Desserts.....	82

# APPETIZER **PREPARATION** AND **SERVING** SUGGESTIONS

- When planning your menu, select an assortment of both hot and cold appetizers.
- It's always wise to select as many make-ahead recipes as possible.
- At minimum, plan on preparing 4 appetizers per guest per hour.
- Set out serving dishes and platters needed for each menu item well in advance of your event.
- Bake your appetizers in batches, so fresh, warm hors d'oeuvres will always be available.
- For recipes calling for cooked chicken, consider:
  - purchasing broasted chicken from the deli
  - steaming, poaching, or grilling chicken breasts or thighs
  - using prepared or packaged chicken strips or cubes
- To keep your hors d'oeuvres at the proper serving temperature, consider using slow cookers, heated chafing dishes, ice baths, and so forth.
- When you're serving exotic or unfamiliar appetizers, label them with decorative place cards on the buffet table. Consider including a short story or explanation of the history, ingredients, or special preparation that went into their creation.

# CRAB-STUFFED MUSHROOMS

Position mini bowl and mini blade in work bowl. Add croissants. Process until finely crumbled, 5 to 10 seconds.

Exchange mini bowl and mini blade for multipurpose blade in work bowl. With processor running, add shallots and garlic through small feed tube. Process until finely chopped, about 5 seconds. Remove stems from mushrooms; add 1 cup stems to work bowl. Pulse 3 to 4 times, about 1 second each time.

In medium skillet over medium heat, melt butter. Add vegetable mixture; cook 4 to 5 minutes, or until tender, stirring often. Return vegetable mixture to work bowl. Add bread crumbs, crabmeat, tarragon, salt, and lemon juice. Process until mixed, 3 to 5 seconds.

Arrange mushrooms cap side down in 15x10x1-inch baking pan. Spoon and press crab mixture into openings, mounding stuffing. Press cheese on top of stuffing. Bake at 350° F for 20 to 25 minutes, or until mushrooms are tender. Sprinkle with chives, if desired.

Yield: 10 servings (3 mushrooms per serving).

Tip: Filling may be made up to one day in advance; refrigerate. Warm to room temperature before stuffing mushrooms.

Per Serving: About 130 cal, 8 g pro, 10 g carb, 7 g total fat, 4 g sat fat, 30 mg chol, 220 mg sod.

- 2 large bakery croissants or white bread slices, torn into pieces
- 2 shallots, cut into quarters
- 2 cloves garlic
- 30 large (about two 14 oz. packages) mushrooms, cleaned
- 1 tablespoon butter
- 1 can (6 oz.) crabmeat, well-drained
- ½ teaspoon dried tarragon
- ¼ teaspoon salt
- 1 tablespoon lemon juice
- 1 cup freshly grated Asiago or Parmesan cheese
- 2 tablespoons snipped fresh chives, if desired

# SESAME-ALMOND CRACKERS

- 1½ cups rolled oats
- 1 cup (about 4 oz.) sliced almonds
- 2 cups all-purpose flour
- 1 cup whole wheat flour
- 2 tablespoons sugar
- 1½ teaspoons salt
- 1 teaspoon baking soda
- ¼ cup shortening
- ¼ cup butter or margarine, slightly softened
- 1¼ cups buttermilk
- 1 egg, beaten
- 1 tablespoon water
- 2 teaspoons coarse salt, divided
- ¼ cup black sesame seeds\*, divided
- ¼ cup white sesame seeds\*, divided

\* Other cracker toppings might include garlic powder, onion powder, sliced almonds, poppy seeds, or sunflower seeds.

Position multipurpose blade in work bowl. Add oats and almonds. Pulse 3 to 4 times, about 5 seconds each time, or until finely ground. Add all-purpose and whole wheat flours, sugar, salt, and baking soda. Process until mixed, 5 to 10 seconds. Add shortening and butter. Pulse 4 to 5 times, about 2 seconds each time, or until crumbly. With processor running, add buttermilk through small feed tube. Process until stiff dough forms, about 30 seconds, scraping sides of bowl if necessary.

In small bowl, combine egg and water. Set aside.

Remove dough to lightly floured work surface. Form into a ball; divide into 4 portions. Keep dough covered until ready to roll. Roll 1 portion into a 10x10-inch square. Place in center of large lightly greased cookie sheet. Roll evenly into a 12x12-inch square. Brush with egg mixture. Sprinkle with ½ teaspoon coarse salt, 1 tablespoon black sesame seeds, and 1 tablespoon white sesame seeds. Roll lightly with rolling pin. With pastry wheel, pizza cutter, or sharp knife, score to form 36 squares, or other desired shape. Do not separate. Repeat with remaining dough, egg mixture, salt, and sesame seeds.

Bake at 350° F for 15 to 25 minutes, or until golden brown. If outside crackers start to brown first, remove them to a cooling rack and continue baking until center crackers are golden brown. Remove crackers to cooling rack.

Yield: 12 dozen (about 6 crackers per serving).

Per Serving: About 160 cal, 5 g pro, 19 g carb, 8 g total fat, 2.5 g sat fat, 15 mg chol, 370 mg sod.

# CARAMELIZED ONION PUFF PASTRY SQUARES

Position 4 mm shredding disc and chef's bowl in work bowl. Add Gouda cheese. Process to shred. Set aside.

Position 4 mm slicing disc in work bowl. Add onions to feed tube, cutting to fit tube, if necessary. Process to slice.

In large skillet or Dutch oven over medium-high heat, heat oil, until it sizzles. Add onions; cook 5 to 10 minutes, or until onions are limp, stirring occasionally. Stir in brown sugar and 2 tablespoons vinegar. Cook over medium-low heat 35 to 45 minutes, or until soft and light golden, stirring occasionally. Stir in remaining 1 tablespoon vinegar, pepper, and salt. Set aside.

On lightly floured surface, roll each sheet of puff pastry into a 12-inch square. Place on 2 large ungreased baking sheets.

Bake at 400° F for 9 to 11 minutes, or until pastry puffs and edges begin to brown, gently pricking top of pastry with fork after 5 minutes. Reduce oven temperature to 375° F. Lightly prick tops of pastry with fork. Sprinkle Parmesan cheese evenly over pastry to within ½ inch of edges. Top evenly with onions. Sprinkle Gouda cheese over onions. Bake at 375° F for 10 to 15 minutes, or until pastry is golden brown and cheese is melted and bubbly. Cool slightly. Cut each pastry into 36 squares.

Yield: 24 servings (3 squares per serving).

Per Serving: About 180 cal, 5 g pro, 13 g carb, 12 g total fat, 4 g sat fat, 15 mg chol, 200 mg sod.

- 1 package (7 oz.) Gouda or smoked Gouda cheese, wax removed
- 4 medium yellow onions
- 1 tablespoon vegetable oil
- 3 tablespoons brown sugar
- 3 tablespoons balsamic vinegar, divided
- ½ teaspoon cracked black pepper
- ⅛ teaspoon salt
- 1 package (17¼ oz.) frozen puff pastry, thawed
- 1 cup freshly grated Parmesan cheese

# HOT ARTICHOKE DIP

- 6 ounces Asiago cheese, room temperature
- 1 red or green jalapeno pepper, seeded and cut into quarters
- 1 clove garlic
- 2 cans (14 oz. each) artichoke hearts\*, well drained
- 1 cup mayonnaise
- ½ cup chive and onion sour cream
- 1 package (3 oz.) cream cheese

\* For chunkier dip, reserve 2 to 3 pieces of artichoke hearts; cut into ½-inch chunks, and stir into dip when adding to baking pan.

Position chef's bowl and 4 mm shredding disc in work bowl. Add Asiago cheese. Process to shred; set aside.

Exchange chef's bowl and shredding disc for multipurpose blade in work bowl. With processor running, add jalapeno pepper and garlic through small feed tube. Process until finely chopped. Add artichoke hearts. Pulse 3 to 4 times, about 2 seconds each time, or until chopped. Add mayonnaise, sour cream, cream cheese, and Asiago cheese. Process until blended, about 5 seconds.

Remove to greased 9-inch quiche pan or pie plate. Bake at 375°F about 20 minutes, or until hot. Serve with crackers, French bread, tiny corn muffins, or crisp vegetables.

Yield: 32 servings (2 tablespoons per serving).

Per Serving: About 90 cal, 2 g pro, 2 g carb, 9 g total fat, 2.5 g sat fat, 15 mg chol, 170 mg sod.

# CAMEMBERT SALMON DIP

Position multipurpose blade in work bowl. Add onions. Process until coarsely chopped, 3 to 4 seconds. Add cream cheese, Camembert cheese, and vinegar, if desired. Process until creamy, 5 to 10 seconds. Add salmon. Process until mixed, 8 to 10 seconds, scraping bowl if necessary. Add peppers and capers. Pulse 5 times, about 1 second each time, until coarsely chopped.

Remove to greased 9-inch pie plate or quiche pan. Bake at 350°F for 10 to 15 minutes, or until heated thoroughly. Garnish with parsley, if desired. Serve with crostini, pita chips, crackers, or vegetable dippers.

Yield: 20 servings (2 tablespoons per serving).

Per Serving: About 80 cal, 7 g pro, 2 g carb, 5 g total fat, 2.5 g sat fat, 20 mg chol, 320 mg sod.

- 4 *green onions, cut into 1-inch pieces*
- 1 *package (8 oz.) light cream cheese, room temperature and cut into 1-inch pieces*
- 4 *ounces soft Camembert cheese, rind removed, if desired, and cut into 1-inch pieces*
- 1 *tablespoon white balsamic vinegar, if desired*
- 2 *cans (7 oz. each) red salmon\**
- 1 *jar (7 oz.) roasted red peppers, well drained and cut into 1-inch pieces*
- 1 *jar (3 oz.) capers, drained*  
*Chopped parsley leaves, if desired*

*\* If desired, reserve 1/3 cup salmon chunks to flake and fold into dip before spreading into baking pan.*

# CHIPOTLÉ DEVEILED EGGS

- $\frac{3}{4}$  cup loosely packed fresh cilantro leaves
- $\frac{1}{2}$  medium onion, cut into 1-inch pieces
- 5–6 chipotle chilies in adobo sauce, drained (from a 7 or 11-oz. can)
- 26 hard-cooked eggs, peeled and cut into halves lengthwise
- 1 cup mayonnaise or salad dressing
- $\frac{1}{4}$  cup sour cream
- $\frac{3}{4}$  teaspoon salt

Position mini bowl and mini blade in work bowl. With processor running, add cilantro through small feed tube. Process until finely chopped, 5 to 8 seconds. Set aside.

Exchange mini bowl and mini blade for multipurpose blade in work bowl. Add onion and chilies to work bowl. Process until finely chopped, 10 to 15 seconds. Add 4 egg halves (whites and yolks) and remaining 48 egg yolk halves. Set remaining 48 egg white halves aside. Process yolk mixture until finely chopped, about 5 seconds. Add mayonnaise, sour cream, salt, and cilantro. Pulse 3 to 5 times, about 2 seconds each time, or until mixed; scrape sides of bowl if necessary.

Pipe or spoon generous amounts of mixture into reserved egg white halves.

Yield: 24 servings (2 egg halves per serving).

Tip: Purchase fresh eggs close to their "sell-by" date for easy peeling after cooking.

Per Serving: About 160 cal, 7 g pro, 1 g carb, 14 g total fat, 3 g sat fat, 235 mg chol, 230 mg sod.

# TROPICAL FRUIT SALSA

Position multipurpose blade in work bowl. With processor running, add cilantro through small feed tube. Process until chopped, 3 to 5 seconds. With processor running, add peppers. Process until chopped, 3 to 5 seconds. Add jicama. Pulse 2 to 3 times, about 2 seconds each time, or until chopped. Add remaining ingredients. Pulse 3 to 4 times, about 2 seconds each time, or until chopped and mixed. Chill at least 1 hour to blend flavors. Serve crackers or pita triangles with cream cheese topped with Tropical Fruit Salsa. Or serve with grilled skewered shrimp.

Yield: 22 servings (¼ cup per serving).

Tip: May be made 1 to 2 days in advance and refrigerated.

Per Serving: About 20 cal, 0 g pro, 6 g carb, 0 g total fat, 0 g sat fat, 0 mg chol, 10 mg sod.

- ½ cup loosely packed fresh cilantro or parsley leaves*
- 1–2 jalapeno peppers, cut into halves and seeded*
- ½ cup jicama chunks*
- 3 cups (about 1 lb.) fresh pineapple chunks*
- 2 seedless oranges, peeled and cut into eighths*
- 1 medium mango, peeled, seeded and cut into chunks*
- 1 tablespoon fresh lime juice*
- ½ teaspoon salt*

# SHRIMP DILL DIP

- 2 *tablespoons fresh dill or 1½ teaspoons dried dill*
- 3 *green onions, cut into 1-inch pieces*
- 1 *strip lemon peel, yellow portion only*
- 2 *packages (8 oz. each) cream cheese, softened*
- 8 *ounces sour cream*
- ½ *cup mayonnaise or salad dressing*
- 2 *tablespoons fresh lemon juice*
- 2–3 *teaspoons horseradish*
- ½–¾ *teaspoon hot pepper sauce*
- ½ *teaspoon salt*
- 2 *packages (7 oz. each) frozen cooked tiny shrimp, thawed and drained*

Position mini bowl and mini blade in work bowl. With processor running, add dill through small feed tube. Process until chopped. Add onions. Process until finely chopped, 5 to 10 seconds. Set aside.

Exchange mini bowl and mini blade for multipurpose blade in work bowl. With processor running, add lemon peel through small feed tube. Process until finely chopped, 5 to 10 seconds. Add cream cheese, sour cream, mayonnaise, lemon juice, horseradish, pepper sauce, and salt. Process until smooth, 10 to 15 seconds. Add dill mixture. Pulse 1 to 2 times, about 2 seconds each time, or until mixed; scrape bowl if necessary. Add shrimp. Pulse 3 times, about 1 second each time, or until mixed.

Before serving, chill at least 1 hour to blend flavors.

Yield: 40 servings (2 tablespoons per serving).

Per Serving: About 80 cal, 3 g pro, 1 g carb, 7 g total fat, 3.5 g sat fat, 35 mg chol, 200 mg sod.

# ROASTED SALSA VERDE

Place yellow and serrano peppers, garlic, tomatillos, bell pepper, and onion in 15x10x2-inch baking pan. Drizzle with oil; toss to coat. On top rack, bake at 450° F about 20 minutes, or until tomatillos are blistered and garlic is tender, stirring once or twice. Cool slightly.

Position multipurpose blade in work bowl. With processor running, add lime peel through small feed tube. Process until chopped, 10 to 15 seconds. Add lime juice, sugar, salt, and vegetable mixture with any accumulated juices. Pulse 2 to 3 times, about 1 second each time, or until chopped. Serve chilled or at room temperature with skewered grilled chicken or shrimp, or tortilla chips.

Yield: 24 servings (2 tablespoons per serving).

Tip: May be made 1 to 2 days in advance, if desired.

Per Serving: About 20 cal, 0 g pro, 3 g carb, 1 g total fat, 0 g sat fat, 0 mg chol, 75 mg sod.

- 3 *mild yellow chile peppers, cut into halves and seeded*
- 2 *serrano chile peppers, cut into halves and seeded*
- 4 *large cloves garlic, peeled*
- 1½ *pounds fresh tomatillos, husks removed*
- 1 *red bell pepper, seeded and cut into 2-inch pieces*
- 1 *small onion, cut into quarters*
- 1 *tablespoon olive or vegetable oil*
- 4 *strips lime peel, green portion only*
- 2 *tablespoons fresh lime juice*
- 2 *teaspoons sugar*
- ¾ *teaspoon salt*

# WHITE BALSAMIC VINAIGRETTE

- 1 *tablespoon fresh basil leaves*
- 1 *tablespoon fresh oregano leaves*
- 1 *clove garlic*
- 3 *tablespoons white balsamic vinegar\**
- 3 *tablespoons white wine vinegar\**
- $\frac{1}{2}$  *teaspoon salt*
- $\frac{1}{4}$  *teaspoon dry mustard*
- $\frac{1}{8}$  *teaspoon ground red pepper*
- $\frac{3}{4}$  *cup extra virgin olive oil*

*\* Three tablespoons each of dark balsamic vinegar and red wine vinegar may be substituted.*

Position multipurpose blade in work bowl. With processor running, add basil, oregano, and garlic through small feed tube. Process until chopped, 5 to 8 seconds. Scrape sides of bowl. With processor running, add balsamic vinegar, wine vinegar, salt, mustard, and red pepper. Process until mixed, about 5 seconds. With processor running, slowly drizzle oil through feed tube. Process until smooth and thick. Serve with green salads.

Yield: 8 servings (2 tablespoons per serving).

Per Serving: About 190 cal, 0 g pro, 1 g carb, 21 g total fat, 3 g sat fat, 0 mg chol, 150 mg sod.

# MEDITERRANEAN HOT CHICKEN SALAD

Position multipurpose blade in work bowl. Add onions, olives, and chicken. Pulse 4 to 6 times, 1 to 2 seconds each time, or until coarsely chopped. Remove to large mixing bowl.

Exchange multipurpose blade for 4 mm slicing disc. Add fennel. Process to slice. Add to mixing bowl.

Exchange slicing disc for mini bowl and mini blade in work bowl. Add all remaining ingredients except cheese and nuts. Process until mixed, 10 to 12 seconds. Add to mixing bowl. Add cheese to mixing bowl; stir to combine.

Spread into greased 13x9x2-inch baking pan. Sprinkle with pine nuts. Bake at 375° F for 25 to 30 minutes, or until thoroughly heated. Serve with pitas, flatbread, or lettuce wraps.

Yield: 10 servings (about  $\frac{3}{4}$  cup per serving).

Per serving: About 440 cal, 30 g pro, 5 g carb, 33 g total fat, 7 g sat fat, 95 mg chol, 510 mg sod.

- 6 *green onions, cut into 1-inch pieces*
- $\frac{1}{2}$  *cup whole pitted kalamata olives*
- 6 *cups (about 1 $\frac{3}{4}$  pounds) cooked chicken chunks*
- 1 *bulb fennel, cut into quarters lengthwise*
- 1 *cup mayonnaise*
- $\frac{1}{2}$  *cup sour cream*
- 1 *tablespoon all-purpose flour*
- 2 *tablespoons fresh oregano leaves*
- 2 *tablespoons lemon juice*
- $\frac{1}{4}$ – $\frac{1}{2}$  *teaspoon salt*
- $\frac{1}{4}$  *teaspoon black pepper*
- 1 *cup (4 oz.) crumbled feta cheese*
- $\frac{1}{2}$  *cup pine nuts*

# CITRUS DRESSING

- 2 *strips lime peel, green portion only*
- 1 *strip orange peel, orange portion only*
- 2 *green onions, cut into 1-inch pieces*
- 1 *cup vegetable oil*
- $\frac{1}{3}$  *cup white wine vinegar*
- 3 *tablespoons fresh lime juice*
- 1 *seedless orange, peeled and sectioned*
- 1 *teaspoon poppy seeds, if desired*
- $\frac{1}{2}$  *teaspoon dry mustard*
- 1 *tablespoon sugar*
- $\frac{1}{4}$  *teaspoon black pepper*

Position multipurpose blade in work bowl. With processor running, add lime and orange peels through small feed tube. Process until chopped, about 20 seconds. Add remaining ingredients. Process until smooth, 10 to 15 seconds. Serve over mixed greens or fruit, or use to marinate chicken, pork, or fish.

Yield: 16 servings (2 tablespoons per serving).

Per Serving: About 130 cal, 0 g pro, 2 g carb, 14 g total fat, 2.5 g sat fat, 0 mg chol, 0 mg sod.

# FRESH JICAMA SALAD

Position multipurpose blade in work bowl. With processor running, add lime peel through small feed tube. Process until minced, 10 to 12 seconds; scrape sides of bowl. Add remaining dressing ingredients. Process until blended, 5 to 8 seconds; scrape sides of bowl.

Exchange multipurpose blade for 4 mm slicing disc in work bowl. Add jicama, oranges, onion, and celery to feed tube in batches. Process to slice. Remove to large mixing bowl. Toss gently to mix and coat. Cover; refrigerate at least 2 hours to blend flavors. Serve on lettuce-lined plate, if desired.

Yield: 8 servings (¾ cup per serving).

Per Serving: About 120 cal, 1 g pro, 14 g carb, 7 g total fat, 1.5 g sat fat, 0 mg chol, 170 mg sod.

## DRESSING

- 2 strips lime peel
- ¼ cup vegetable oil
- 2 tablespoons lime juice
- 1 teaspoon Dijon mustard
- ½ teaspoon sugar
- ½ teaspoon salt
- ⅛–¼ teaspoon crushed red pepper

## SALAD

- 1 medium (about 1 lb.) jicama, peeled and cut into eighths lengthwise
- 2 seedless oranges, peeled and cut into halves lengthwise
- ½ red onion, cut into halves lengthwise
- 2 ribs celery, cut into 2½-inch pieces
- Lettuce leaves, if desired

# CHICKEN WILD RICE SALAD

## SALAD

- 8–10 *medium green onions, cut into 1-inch pieces*
- 6 *boneless, skinless chicken breast halves (about 2 lb.), grilled or broiled and cooled*
- 1 *large red bell pepper, seeded and cut into quarters lengthwise*
- 2 *medium ribs celery*
- 5 *cups cooked wild rice, cooled*

## DRESSING

- $\frac{3}{4}$  *cup vegetable oil*
- $\frac{1}{3}$  *cup white wine or rice wine vinegar*
- 2 *tablespoons Dijon mustard*
- $\frac{3}{4}$  *teaspoon salt*
- $\frac{3}{4}$  *teaspoon cracked black pepper*
- $\frac{1}{2}$ – $\frac{3}{4}$  *teaspoon hot pepper sauce*

Position multipurpose blade in work bowl. Add onions. Pulse 1 to 2 times, about 2 seconds each time, or until chopped.

Exchange multipurpose blade for 4 mm slicing disc in work bowl. Add chicken, bell pepper, and celery in batches. Process to slice. Remove to large mixing bowl. Add rice; toss to mix.

Exchange slicing disc for multipurpose blade in work bowl. Add dressing ingredients. Process until smooth, 3 to 5 seconds. Pour dressing over salad mixture. Toss to coat.

Yield: 12 servings.

Tip: Entire salad may be assembled 1 day in advance and refrigerated.

Per serving: About 270 cal, 17 g pro, 16 g carb, 16 g total fat, 3 g sat fat, 35 mg chol, 260 mg sod.

# ASIAN COLESLAW FOR A CROWD

Position 4 mm slicing disc in work bowl. Add cabbage and onion in batches, cutting to fit feed tube if necessary. Process to slice. Remove to very large mixing bowl.

Remove and reserve seasoning packets from noodles. Crumble noodles into cabbage mixture. Add nuts; toss to mix.

Exchange slicing disc for multipurpose blade in work bowl. Add oil, vinegar, sugar, and contents of noodle seasoning packets. Process until blended and sugar is dissolved, 10 to 15 seconds. Pour dressing over salad. Toss to coat.

Chill at least 1 hour before serving to blend flavors.

Yield: 32 servings (½ cup per serving).

Tip: Recipe may be halved, if desired.

Per serving: About 80 cal, 1 g pro, 7 g carb, 5 g total fat, 1 g sat fat, 0 mg chol, 80 mg sod.

## SALAD

- 1 large head (about 2 lb.) Napa cabbage, cored
- 1 medium red onion, cut into quarters lengthwise
- 2 packages (3 oz. each) ramen noodles (shrimp, chicken, or vegetable flavor)
- ½ cup salted sunflower nuts

## DRESSING

- ½ cup vegetable oil
- ¼ cup white wine vinegar
- ¼ cup sugar

# HOT POTATO SALAD

- 12 *medium (about 2 lb.) red potatoes boiled, peeled and cooled*
- 1 *medium onion, cut into halves lengthwise*
- $\frac{1}{4}$  *medium red bell pepper, cut into quarters lengthwise*
- 6 *slices thick bacon*
- 2 *tablespoons all-purpose flour*
- 2 *tablespoons sugar*
- $\frac{3}{4}$  *teaspoon celery seed*
- $\frac{1}{2}$  *teaspoon salt*
- $\frac{1}{2}$  *teaspoon cracked black pepper*
- $1\frac{1}{4}$  *cups water*
- $\frac{1}{3}$  *cup cider vinegar*
- Chopped fresh parsley, if desired*

Position chef's bowl and 4 mm slicing disc in work bowl. Add potatoes. Process to slice. Set aside.

Exchange chef's bowl and slicing disc for 2 mm slicing disc in work bowl. Add onion and bell pepper. Process to slice. Set aside.

In 12-inch skillet over medium heat, cook bacon until crisp. Remove bacon, reserving 3 tablespoons drippings. Drain bacon on paper towels, crumble, and set aside. Place reserved drippings in skillet. Add onion mixture. Cook and stir over medium-low heat 3 to 4 minutes, or until tender. Add flour, sugar, celery seed, salt, and black pepper; mix well.

Add water and vinegar. Heat to boiling, stirring constantly. Boil for 1 minute; add reserved potatoes and bacon. Stir gently to blend. Heat until warm. Garnish with chopped fresh parsley, if desired.

Yield: 10 servings ( $\frac{3}{4}$  cup per serving).

Per serving: About 160 cal, 3 g pro, 23 g carb, 6 g total fat, 2.5 g sat fat, 10 mg chol, 280 mg sod.

# BROCCOLI-KOHLRABI CONFETTI SALAD

Position multipurpose blade in work bowl. Add cauliflower. Pulse 5 to 6 times, about 1 second each time, or until chopped. Remove to large mixing bowl.

Cut broccoli florets into 1½-inch pieces and reserve stalk. Add florets to work bowl. Pulse 3 to 5 times, about 1 second each time, or until chopped. Add to mixing bowl.

Exchange multipurpose blade for 4 mm shredding disc in work bowl. Add kohlrabi, carrots, and reserved broccoli stalk, cutting to fit feed tube if necessary. Process to shred. Add to mixing bowl.

Exchange shredding disc for multipurpose blade in work bowl. Add dressing ingredients. Process until smooth, 10 to 15 seconds. Pour dressing over vegetables. Toss to coat.

Chill at least 1 hour to blend flavors.

Yield: 20 servings (½ cup per serving).

Per serving: About 70 cal, 1 g pro, 4 g carb, 6 g total fat, 1 g sat fat, 0 mg chol, 85 mg sod.

## SALAD

- 1 package (1 lb.) fresh cauliflower florets, cut into 1½-inch pieces
- 1 stalk (about ¾ lb.) broccoli
- 2 bulbs kohlrabi, peeled
- 3 medium carrots, peeled

## DRESSING

- ½ cup vegetable oil
- ¼ cup red wine vinegar
- 2 tablespoons fresh lemon juice
- 3 green onions, cut into 1-inch pieces
- 1½ teaspoons prepared mustard
- 1 teaspoon sugar
- ½ teaspoon salt
- ½–¾ teaspoon cracked black pepper

# CHEDDAR BROCCOLI SOUP

- 2 *tablespoons fresh parsley leaves*
- 8 *ounces sharp Cheddar cheese, chilled*
- 1 *small onion, cut into halves*
- 1 *rib celery, cut into 2½-inch pieces*
- 2 *tablespoons butter or margarine*
- 1 *large stalk (about 1 lb.) broccoli*
- 3½ *cups chicken broth*
- 2 *cups milk, divided*
- ¼ *cup all-purpose flour*
- 2 *teaspoons Dijon mustard*
- 1 *teaspoon curry powder, if desired*
- ⅛ *teaspoon hot pepper sauce*

Position mini bowl and mini blade in work bowl. With processor running, add parsley through small feed tube. Process until coarsely chopped, 5 to 10 seconds. Set aside.

Exchange mini bowl and mini blade for chef's bowl and 4 mm shredding disc. Add cheese. Process to shred. Set aside.

Exchange chef's bowl and shredding disc for 2 mm slicing disc in work bowl. Add onion and celery. Process to slice. Melt butter in large saucepan or Dutch oven over medium heat. Remove onion and celery to saucepan. Cook 5 to 6 minutes, or until crisp-tender, stirring occasionally.

Cut stems from broccoli, and peel tough coating from stems. Cut florets into small pieces. Position 2 mm slicing disc in work bowl. Add broccoli stems. Process to slice. Remove to saucepan.

Add broccoli florets and broth to saucepan. Bring to a boil over medium-high heat. Reduce heat; partially cover and simmer 8 to 10 minutes, or until broccoli is crisp-tender, stirring occasionally. Remove from heat.

Exchange slicing disc for multipurpose blade in work bowl. With slotted spoon, remove vegetables from saucepan to work bowl. Add 1 cup milk. Process until chopped, 5 to 8 seconds.

In medium mixing bowl, whisk flour into remaining 1 cup milk, whisking until smooth. Add mustard, curry powder, if desired, and pepper sauce. Stir until combined.

Add milk mixture to broth in saucepan. Cook over medium-high heat until bubbly and slightly thickened, stirring often. Reduce heat to low. Add cheese; stir until melted.

Add broccoli mixture to saucepan. Heat thoroughly. Garnish each serving with parsley.

Yield: 8 servings (1 cup per serving).

Per Serving: About 220 cal, 12 g pro, 13 g carb, 14 g total fat, 8 g sat fat, 45 mg chol, 710 mg sod.

# CHICKEN CHUTNEY SANDWICH SPREAD

Position chef's bowl and 4 mm slicing disc in work bowl. Add chicken and jicama to feed tube. Process to slice. Exchange chef's bowl and slicing disc for multipurpose blade in work bowl. Remove chicken and jicama to work bowl. Add walnuts, mayonnaise, chutney, salt, and pepper. Pulse 3 to 4 times, about 2 seconds each time, or until finely chopped and thoroughly mixed. Spread on bread for sandwiches, or wrap in lettuce leaves for wraps.

Yield: 7 servings (½ cup per serving).

Tip: Chicken may be made 1 day ahead and refrigerated.

Per Serving: About 300 cal, 9 g pro, 21 g carb, 21 g total fat, 2.5 g sat fat, 25 mg chol, 590 mg sod.

4 *grilled or broiled boneless, skinless chicken breast halves\**, cooled

1 *cup cubed jicama*

⅓ *cup walnuts*

½ *cup mayonnaise or salad dressing*

1 *jar (9 oz.) mango chutney (about ⅓ cup)*

¼–½ *teaspoon salt*

¼ *teaspoon black pepper*

\* *Eight boneless, skinless chicken thighs may be substituted for breasts.*

# ROASTED BUTTERNUT SQUASH SOUP

## WITH HERB PISTOU

### SOUP

- 1 *large (about 2½ lb.) butternut squash, peeled, seeded, and cut into quarters lengthwise*
- 1 *large onion, cut into halves lengthwise*
- 2 *large cloves garlic, cut into quarters*
- 2 *tablespoons olive oil*
- 5 *cups chicken broth, divided*
- 1 *can (15 oz.) pumpkin puree*
- $\frac{3}{4}$  *teaspoon salt*
- 1 *cup whipping cream*

### SAUCE

- 2 *cups loosely packed fresh parsley leaves*
- $\frac{1}{4}$  *cup loosely packed fresh sage leaves*
- 2 *tablespoons fresh thyme leaves*
- 2 *cloves garlic*
- 1 *teaspoon lemon juice*
- $\frac{1}{4}$  *teaspoon salt*
- $\frac{1}{3}$  *cup olive oil*

### SOUP

Position 4 mm slicing disc in work bowl. Add squash and onion in batches. Process to slice. Remove to 15x10x1-inch pan. Add garlic and drizzle with oil; toss to coat. Bake at 450° F for 30 to 35 minutes, or until tender, stirring once or twice. (Pan will be very full at first but decreases as vegetables cook.) Cool slightly.

Exchange slicing disc for multipurpose blade in work bowl. Add roasted vegetable mixture and juices, 1½ cups broth, pumpkin, and salt. Process until well mixed, about 1 minute. With processor running, add an additional 1½ cups broth through small feed tube. Process until smooth, 45 to 60 seconds. Remove to large saucepan or Dutch oven. Stir in remaining 2 cups broth.

Cook over medium heat until thoroughly heated. Stir in cream; heat just until hot. Top each serving with about 2 teaspoons Herb Pistou.

### PISTOU SAUCE

Position mini bowl and mini blade in work bowl. With processor running, add parsley, sage, thyme, garlic, lemon juice, and salt through the small feed tube. Process until finely chopped, about 5 seconds; scrape sides of bowl if necessary. With processor running, gradually add oil. Process until well mixed.

Yield: 10 (1 cup servings).

Per Serving: About 220 cal, 3 g pro, 19 g carb, 16 g total fat, 6 g sat fat, 30 mg chol, 700 mg sod.

# RUNZA POCKET SANDWICHES

Combine milk, water, and butter in small saucepan. Heat until warm, 105°F to 115°F. Stir in yeast to dissolve. Set aside.

Position dough blade in work bowl. Add 4½ cups flour, sugar, and salt. Process until mixed, 5 to 8 seconds. With processor running, slowly add yeast mixture through small feed tube. Add eggs. Process 1 minute, adding up to an additional ½ cup flour, if necessary, for dough to pull from side of bowl. Dough will be sticky. Remove dough to greased bowl, turning to grease all sides. Cover. Let dough rest about 30 minutes.

Meanwhile, exchange dough blade for chef's bowl and 4 mm slicing disc. Add cabbage to feed tube in batches. Process to slice. Set aside.

Exchange chef's bowl and slicing disc for multipurpose blade in work bowl. Add onion. Pulse 2 to 3 times, about 2 seconds each time, or until chopped. Remove to medium skillet; add beef, salt, and pepper. Cook over medium-high heat until beef is thoroughly cooked, onion is tender, and most liquid has evaporated, stirring often. Set aside.

In Dutch oven or large skillet over medium-high heat, melt butter. Add cabbage; cook until cabbage wilts, 7 to 10 minutes. Add beef mixture; toss to mix. Set aside.

Divide dough in half. On floured surface, roll half of dough into a 20x15-inch rectangle (about ⅛-inch thick). With pizza cutter or knife, cut into 12 squares. Place ¼ cup meat mixture in center of each square. Bring corners of dough together to center of Runza. Pinch edges and corners together to seal. Place seam side up on lightly greased baking sheet. Cover; let rise in warm place 30 minutes. Bake at 350°F for 18 to 20 minutes, or until golden brown. Serve with favorite mustard, if desired.

Yield: 12 servings (2 sandwiches per serving).

Tip: To freeze, place unbaked Runzas in a sealed bag and freeze for up to 1 month. Bake at 350°F for 25–35 minutes, or until golden brown.

Per Serving: About 460 cal, 19 g pro, 47 g carb, 22 g total fat, 12 g sat fat, 105 mg chol, 640 mg sod.

## DOUGH

- ¾ cup milk
- ½ cup water
- ½ cup butter or margarine, cut into chunks
- 2 packages active dry yeast
- 4½–5 cups all-purpose flour, divided
- ½ cup sugar
- 1 teaspoon salt
- 2 eggs

## FILLING

- 1½ pounds (about ½ medium head) cabbage, cut into 3-inch chunks
- 1 medium onion, cut into 1-inch pieces
- 1½ pounds lean ground beef
- 2 teaspoons salt
- ½ teaspoon black pepper
- 6 tablespoons butter or margarine

# PAN-FRIED VEGGIE BURGERS

- 8 ounces Monterey Jack cheese, chilled
- 2 large cloves garlic
- ¼ small red onion, cut into 1-inch pieces
- 1 cup fresh mushrooms
- ¼ medium green bell pepper, cut into 1-inch pieces
- 1 medium rib celery, cut into 1-inch pieces
- 1 can (16 oz.) pinto or kidney beans, well drained
- 1 can (8¾ oz.) whole kernel corn, drained
- 2 cups cooked brown rice (not instant)
- ⅓ cup dry bread crumbs
- 1 teaspoon ground cumin
- ¾ teaspoon dried oregano
- ¾ teaspoon black pepper
- ¼ teaspoon cayenne pepper
- ¼ teaspoon salt
- 1–2 tablespoons olive oil
- 1–2 tablespoons butter or margarine

Position chef's bowl and 4 mm slicing disc in work bowl. Add cheese. Process to slice. Set aside.

Exchange slicing disc for multipurpose blade in work bowl. With processor running, add garlic through small feed tube. Process until finely chopped, 5 to 8 seconds. Add onion, mushrooms, bell pepper and celery. Pulse 4 to 5 times, about 2 seconds each time, or until chopped.

Add beans, corn, rice, bread crumbs, cumin, oregano, black pepper, cayenne pepper, and salt. Pulse 3 to 4 times, about 1 second each time, or until just mixed. Shape into 8 patties (about ½ cup each).

In large nonstick skillet over medium heat, heat olive oil and butter. Add patties in batches, if necessary. Cook about 4 minutes, or until golden brown. Carefully turn. Top each patty with cheese. Reduce to medium-low heat. Cook 5 to 6 minutes, or until patties are golden brown and cheese is melted.

If desired, serve with whole wheat sandwich buns or pita pockets, tomato slices, leaf lettuce, mayonnaise, and mustard.

Yield: 8 servings.

Per serving: About 290 cal, 12 g pro, 31 g carb, 13 g total fat, 6 g sat fat, 35 mg chol, 350 mg sod.

# WINTER VEGETABLE SOUP

In large Dutch oven or stockpot over high heat, add broth, water, pork hocks, onion, 1 celery rib, garlic, bay leaves, ½ teaspoon thyme, and pepper. Bring to a boil. Reduce heat, cover, and simmer 1 ½ hours.

Meanwhile, position multipurpose blade in work bowl. Add leeks. Pulse 5 to 6 times, about 1 second each time, or until chopped. Exchange multipurpose blade for 4 mm slicing disc. Add parsnips, carrots, and remaining 1 rib celery in batches, cutting to fit feed tube if necessary. Process to slice. In large saucepan or Dutch oven over medium heat, heat oil. Add vegetable mixture. Cook and stir 8 to 10 minutes, or until crisp-tender. Set aside.

Position chef's bowl and 4 mm slicing disc in work bowl. Add squash, rutabaga, and turnips in batches, cutting to fit feed tube. Process to slice. Set aside.

Exchange slicing disc for 4 mm shredding disc in work bowl. Add potatoes. Process to shred. Set aside.

Remove pork hocks from broth. Remove meat, cut into small pieces, and set aside. Strain broth; skim fat from broth, if desired.

Continued...

- 6 cups chicken broth
- 1½ cups water
- 2–2½ pounds smoked pork hocks
- 1 medium onion, cut into quarters
- 2 large ribs celery, cut into 2½-inch pieces, divided
- 3 cloves garlic, peeled and quartered
- 2 bay leaves
- 1½ teaspoons thyme, divided
- ½ teaspoon black pepper
- 2 medium leeks, white part only, cut into 1-inch pieces
- 4 parsnips, peeled
- 3 large carrots, peeled
- ¼ cup olive oil
- 1 small (about 1 lb.) butternut squash, peeled, seeded, and cut into quarters lengthwise
- 1 medium (about 1 lb.) rutabaga, peeled and cut into 2-inch pieces

Continued...

# WINTER VEGETABLE SOUP

- 2 *turnips, peeled and cut into quarters lengthwise*
- 2 *medium russet potatoes, peeled*
- $\frac{1}{2}$  *cup fresh parsley leaves, if desired*

Add cooked and raw vegetables to broth with remaining 1 teaspoon thyme. Heat to boiling. Reduce heat, cover, and simmer 30 to 45 minutes, or until vegetables are tender.

Exchange shredding disc for mini bowl and mini blade in work bowl. With processor running, add parsley through small feed tube. Process until finely chopped, about 10 seconds.

Add parsley and reserved meat pieces to soup. Heat 10 minutes and serve.

Yield: 16 servings (1 cup per serving).

Tips: For vegetarian soup, omit pork and substitute vegetable broth for chicken broth. Soup also freezes well.

Per Serving: About 170 cal, 7 g pro, 20 g carb, 7 g total fat, 1.5 g sat fat, 15 mg chol, 400 mg sod.

# MUFFALETTA SANDWICHES

Position chef's bowl and 4 mm slicing disc in work bowl. Add tomatoes to feed tube; process to slice. Set aside.

Exchange chef's bowl and slicing disc for multipurpose blade in work bowl. With processor running, add basil and parsley through the small feed tube. Process to chop, about 5 seconds. With processor running, add garlic. Process until chopped, 5 to 10 seconds. Add onion to work bowl. Pulse 2 to 3 times, about 1 second each time, or until chopped. Scrape sides if necessary. Add green, ripe, and kalamata olives, roasted red peppers, vinegar, oregano, black pepper, and olive oil to work bowl. Process until blended, about 10 seconds.\*

Spread about 2 tablespoons olive mixture on each side of bread. Top with meats and cheese. To warm, if desired, wrap each sandwich loosely in foil. Bake at 375° F for 15 to 20 minutes, or until hot and cheese is melted.

Yield: 12 servings.

Tip: Olive mixture may be made 1 to 2 days in advance and refrigerated. Also, serve as dip with crackers or toasted pita triangles.

Per Serving: About 850 cal, 36 g pro, 74 g carb, 45 g total fat, 14 g sat fat, 70 mg chol, 2520 mg sod.

\* Twelve hoagie buns may be substituted for bread.

- 2 medium plum tomatoes
- 4 large fresh basil leaves, if desired
- 3 tablespoons fresh parsley leaves
- 4 large cloves garlic
- $\frac{1}{8}$  small red onion, peeled and cut into 1-inch pieces
- $\frac{1}{2}$  cup pimiento-stuffed green olives
- 1 cup pitted ripe olives
- 1 cup pitted kalamata olives
- $\frac{1}{2}$  cup prepared roasted red peppers, drained
- 2 tablespoons white wine vinegar
- $\frac{1}{2}$  teaspoon dried oregano
- $\frac{1}{2}$  teaspoon coarse black pepper
- $\frac{1}{2}$  cup extra virgin olive oil
- 3 loaves French bread, cut into 6-inch lengths and split lengthwise
- 1 pound thinly sliced salami
- 1 pound thinly sliced smoked ham or prosciutto
- 12 slices provolone cheese

# FRENCH ONION SOUP

- 1 *pound Gruyere or Swiss cheese, room temperature*
- 4 *jumbo yellow onions, cut into halves lengthwise*
- 6 *tablespoons butter or margarine*
- 2 *tablespoons all-purpose flour*
- $\frac{3}{4}$  *teaspoon black pepper*
- 6 *cups beef broth*
- 2 *cups chicken broth*
- $\frac{3}{4}$  *cup dry sherry*
- $1\frac{1}{2}$  *teaspoons Worcestershire sauce*
- 14 *slices French bread ( $\frac{1}{2}$ -in. thick diagonal slices), lightly toasted*
- 5 *ounces freshly grated Parmesan cheese*

Position chef's bowl and 4 mm shredding disc in work bowl. Add Gruyere cheese. Process to shred. Set aside.

Exchange chef's bowl shredding disc for 4 mm slicing disc in work bowl. Add onions in batches. Process to slice.

In Dutch oven over medium-high heat, melt butter. Add onions. Cook and stir 10 to 15 minutes, or until onions are tender. Add flour and pepper; mix well. Add beef and chicken broths, sherry, and Worcestershire sauce. Heat to boiling. Reduce heat; simmer 10 to 15 minutes, or until flavors are blended.

Spoon 1 cup soup into each of 14 individual oven-proof bowls. Top with bread and Gruyere cheese. Sprinkle with Parmesan cheese. Place under broiler, 4 to 6 inches from heat, for 2 to 3 minutes, or until cheese is melted and bubbly.

Yield: 14 servings (1 cup per serving).

Per Serving: About 360 cal, 19 g pro, 23 g carb, 20 g total fat, 12 g sat fat, 60 mg chol, 950 mg sod.

# CREOLE GUMBO

Position mini bowl and mini blade in work bowl. With processor running, add parsley through small feed tube. Process until chopped, 10 to 15 seconds. Set aside.

Exchange mini bowl and mini blade for multipurpose blade in work bowl. With processor running, add garlic through small feed tube. Process until chopped, 5 to 10 seconds. Add bell peppers, celery, and onions. Pulse 4 to 5 times, about 2 seconds each time, or until chopped. Scrape sides of bowl. Set aside.

In large heavy saucepan or skillet over medium-low heat, combine oil and flour. Cook until dark brown (about the color of chocolate syrup), 20 to 25 minutes, stirring constantly. Reduce heat to low as mixture darkens. Remove from heat immediately. Add chopped vegetables. Cook over low heat until crisp-tender, about 15 minutes, stirring frequently.

Meanwhile, in Dutch oven over medium-high heat, melt butter. Add chicken. Cook until browned, 4 to 5 minutes, stirring occasionally.

Continued...

- 1/4 cup loosely packed parsley leaves*
- 4 cloves garlic, peeled*
- 2 medium green bell peppers, seeded and cut into 2-inch pieces*
- 2 medium ribs celery, cut into 1-inch pieces*
- 2 medium onions, cut into 1-inch pieces*
- 1/2 cup vegetable oil*
- 2/3 cup all-purpose flour*
- 2 tablespoons butter or margarine*
- 2 pounds chicken breast tenders, cut into halves crosswise*
- 1/2 pound smoked ham or Polish sausage, cut into 1-inch pieces*
- 1 can (28 oz.) diced tomatoes, undrained*
- 1 package (16 oz.) frozen sliced okra*
- 3 cups chicken broth*

Continued...

# CREOLE GUMBO

- 1 *tablespoon Worcestershire sauce*
- 2 *teaspoons salt*
- 1½ *teaspoons sugar*
- 1½ *teaspoons fresh thyme leaves or ½ teaspoon dried thyme*
- 2 *bay leaves*
- ½ *teaspoon crushed red pepper flakes*
- ½ *teaspoon hot pepper sauce*
- 2 *pounds uncooked medium shrimp, shelled and deveined*

Meanwhile, position multipurpose blade in work bowl. Add ham. Pulse 3 or 4 times, about 2 seconds each time, or until coarsely chopped. Remove to Dutch oven. Add cooked vegetable mixture, parsley, and remaining ingredients except shrimp. Heat until bubbly. Reduce heat; cover and simmer 30 to 40 minutes, or until flavors blend and chicken and vegetables are tender. Add shrimp. Cook 5 to 8 minutes, or until shrimp turn pink and opaque.

Remove and discard bay leaves. Serve in bowls over hot cooked rice.

Yield: 16 servings (1 cup per serving).

Per Serving: About 250 cal, 26 g pro, 11 g carb, 11 g total fat, 3 g sat fat, 125 mg chol, 810 mg sod.

# SWEET DILLED CUCUMBERS AND ONIONS

Position multipurpose blade in work bowl. Add ½ cup vinegar, dill, sugar, salt, and pepper. Process until dill is finely chopped and sugar is dissolved, about 10 seconds. Add remaining ½ cup vinegar. Pulse about 1 second, or until mixed.

Exchange multipurpose blade for 4 mm slicing disc in work bowl. Add cucumbers and onion, cutting to fit if necessary. Process to slice.

Remove to large bowl or large resealable food storage plastic bag; mix well. Refrigerate 8 hours or overnight, stirring or turning occasionally.

Drain cucumbers and onions well. Stir in sour cream.

Yield: 16 servings (½ cup per serving).

Per Serving: About 50 cal, 1 g pro, 7 g carb, 3 g total fat, 2 g sat fat, 5 mg chol, 160 mg sod.

- 1 cup white wine vinegar, divided
- ½ cup firmly packed fresh dill
- ⅓ cup sugar
- 1 teaspoon salt
- ¼ teaspoon black pepper
- 3 medium seedless cucumbers, cut into 2½-inch lengths
- 1 medium onion, cut into halves lengthwise
- 1 cup sour cream

# LAYERED EGGPLANT AND PEPPER CASSEROLE

- 1 *medium eggplant (about 1½ lb.)*
- 3 *tablespoons olive oil*
- 4 *ounces mozzarella cheese*
- 2 *ounces Parmesan cheese*
- 1 *cup ricotta cheese*
- 1 *egg*
- ¼ teaspoon salt, if desired*
- ¼ teaspoon pepper*
- 2 *cups prepared tomato basil pasta sauce, divided*
- 1 *jar (7 oz.) roasted red peppers, well drained*

Position chef's bowl and 4mm slicing disc in work bowl. Cut eggplant into 2½-inch lengths to fit feed tube. Process to slice. Remove to 15x10x1-inch pan, and arrange evenly. (Slices will overlap.) Drizzle with olive oil. Bake at 450° F for 8 minutes, or until slightly tender.

Meanwhile, exchange slicing disk for shredding disc. Add mozzarella to feed tube. Process to shred. Set aside.

Position 4 mm shredding disc in work bowl. Add Parmesan cheese to feed tube. Process to shred. Exchange shredding disc for multipurpose blade. Add ricotta cheese, egg, salt, and black pepper to work bowl. Process about 10 seconds, or until mixed.

Pour 1 cup pasta sauce into greased 12x8x2-inch baking pan. Layer half of eggplant on top of sauce. Top with half of red peppers and half of ricotta cheese mixture. Repeat layers of eggplant, red peppers, and ricotta cheese. Top with remaining pasta sauce and mozzarella cheese. Bake at 350° F. for 30 minutes or until eggplant is tender and casserole is bubbly.

Yield: 8 servings.

Per Serving: About 250 cal, 12 g pro, 19 g carb, 14 g total fat, 6 g sat fat, 50 mg chol, 610 mg sod.

# SPRING MIX BASMATI RICE

Position multipurpose blade in work bowl. With processor running, add garlic to small feed tube. Process 5 seconds. Add shallot. Pulse 2 to 3 times, about 2 seconds each time, or until chopped. In Dutch oven or large saucepan over medium-low heat, heat oil and melt butter. Add shallot mixture. Cook until tender, 1 to 2 minutes, stirring often. Remove from heat; set aside.

Exchange multipurpose blade for 4 mm slicing disk in work bowl. Add green beans and carrot to feed tube. Process to slice. Remove to Dutch oven with shallot mixture. Add broth, water, salt, black pepper, and coriander, if desired. Bring to a boil. Stir in rice. Return to boil; reduce heat. Cover, simmer 15 to 20 minutes, or until liquid is absorbed.

Meanwhile, cut tips from asparagus and reserve stalks; set aside. Position multipurpose blade in work bowl. With processor running, add thyme and parsley to small feed tube. Process until chopped, about 3 seconds. Add bell pepper. Pulse 2 to 3 times, 1 to 2 seconds each time, or until coarsely chopped. Exchange multipurpose blade for 4 mm slicing disk in work bowl. Add asparagus stalks to feed tube. Process to slice. Remove to Dutch oven with rice mixture. Add asparagus tips; stir well.

Cover; let stand 10 minutes. Fluff with a fork.

Yield: 12 servings (1 cup per serving).

Per Serving: About 200 cal, 4 g pro, 44 g carb, 2.5 g total fat, 1 g sat fat, 5 mg chol, 530 mg sod.

- 2 cloves garlic
- 1 medium shallot, cut into quarters
- 1 tablespoon olive oil
- 1 tablespoon butter or margarine
- ½ pound (about 2 cups) fresh green beans, trimmed
- 1 medium carrot, peeled and cut into 2 pieces
- 3 cups chicken broth
- 2 cups water
- 1½ teaspoons salt
- ¼ teaspoon black pepper
- 2 teaspoons ground coriander, if desired
- 2⅔ cups basmati or jasmine rice
- ½ pound fresh asparagus
- 1 tablespoon fresh thyme leaves
- ¼ cup loosely packed fresh parsley leaves
- ¼ small red bell pepper, cut into quarters

# BOURBONED CARROTS

- 1½ pounds carrots, peeled*
- ½ pound parsnips\*, peeled*
- ½ small onion*
- ¼ cup packed brown sugar*
- ½ cup bourbon*
- 3 tablespoons water*
- 3 tablespoons butter  
or margarine*
- ¼ teaspoon salt*
- ⅛ teaspoon black pepper*

*\* If desired, substitute an additional ½ pounds carrots for parsnips.*

Position 4 mm slicing disc in work bowl. Add carrots, parsnips, and onion in batches, cutting to fit feed tube if necessary. Process to slice.

In large skillet or Dutch oven over medium-high heat, combine brown sugar, bourbon, and water. Bring to a boil. Add carrot mixture; stir to coat. Bring to a boil. Cover; cook over medium heat 5 minutes. Uncover; simmer 5 to 10 minutes, or until liquid evaporates and carrots are coated and tender. Add butter, salt, and pepper. Stir to coat.

Yield: 8 servings (½ cup per serving).

Per Serving: About 130 cal, 1 g pro, 18 g carb, 4.5 g total fat, 2.5 g sat fat, 10 mg chol, 125 mg sod.

# LOADED BAKED POTATO CASSEROLE

In 12-inch skillet over medium heat, cook bacon until crisp. Remove bacon, reserving 3 tablespoons drippings; drain bacon on paper towels, crumble, and set aside.

Position chef's bowl and 4 mm shredding disc in work bowl. Add Cheddar cheeses and Parmesan cheese in batches, cutting to fit feed tube if necessary. Process to shred. Set aside.

In Dutch oven over high heat, add water and 1½ teaspoons salt; bring to boil. Meanwhile, position 4 mm shredding disc in work bowl. Add potatoes in batches, cutting to fit feed tube if necessary. Process to shred. If desired, rinse potatoes and drain well. When water boils, add potatoes; return to a boil. Cook 1 minute, or until crisp-tender. Drain well.

Exchange shredding disc for mini work bowl and mini blade in work bowl. With processor running, add parsley and onions through small feed tube. Process until chopped, 2 to 3 seconds. Set aside.

In large mixing bowl, combine sour cream, flour, remaining ¾ teaspoon salt, pepper, milk, and reserved bacon drippings; mix well. Add potatoes, shredded cheeses, onion mixture, and reserved bacon; toss gently to mix well. Spread into greased 13x9x2-inch baking pan.

Split French bread lengthwise. Butter cut sides; place cut sides together. Cut into 1-inch pieces. Exchange mini bowl and mini blade for multipurpose blade in work bowl. Add buttered bread to work bowl. Process until fine crumbs form, 5 to 8 seconds. Sprinkle crumb mixture over potatoes. Bake at 350° F for 60 to 75 minutes, or until golden brown and edges are bubbly.

Yield: 16 servings (¾ cup per serving).

Per Serving: About 330 cal, 12 g pro, 23 g carb, 22 g total fat, 12 g sat fat, 60 mg chol, 430 mg sod.

- 6 strips bacon
- 8 ounces extra sharp Cheddar cheese, chilled
- 6 ounces smoked sharp Cheddar cheese, chilled
- 2 ounces Parmesan cheese, room temperature
- 2½ quarts water
- 2¼ teaspoons salt, divided
- 3 pounds russet potatoes
- ⅓ cup loosely packed fresh parsley leaves
- 8 green onions, cut into 1-inch pieces
- 3 cups sour cream
- 3 tablespoons all-purpose flour
- ¾ teaspoon cracked black pepper
- ⅔ cup milk
- 1 slice (3 in.) French bread
- 1 tablespoon butter or margarine, softened

# SZECHWAN PORK

- 4 *large cloves garlic*
- $\frac{1}{4}$  *cup peeled ginger root chunks*
- $\frac{1}{4}$  *cup soy sauce*
- 2 *tablespoons sherry*
- 2 *teaspoons dark sesame oil, divided*
- $1\frac{1}{2}$  *pounds pork tenderloin, cut into 3-inch pieces and frozen for 1 to 1½ hours*
- $2\frac{1}{2}$ –3 *teaspoons crushed red pepper flakes*
- 1 *red or yellow bell pepper, cut into halves lengthwise, and seeded*
- 3 *ribs celery, cut into 2½-inch pieces*
- 6 *green onions, cut diagonally into ½-inch slices*
- 1 *cup chicken broth*
- 1 *tablespoon cornstarch*
- Hot cooked rice or Chinese noodles, if desired*

Position multipurpose blade in work bowl. With processor running, add garlic and ginger root through small feed tube. Process until chopped, 5 to 8 seconds. Scrape sides of bowl. Add soy sauce, sherry, 1 teaspoon sesame oil, and red pepper flakes. Process until mixed, about 5 seconds. Scrape sides of bowl, if necessary.

Exchange multipurpose blade for 4 mm slicing disc in work bowl. Add pork. Process to slice. Remove to shallow dish or large resealable food storage plastic bag; coat pork with marinade. Refrigerate for 1 hour.

Meanwhile, wash processor. Position 4 mm slicing disc in work bowl. Add bell peppers and celery. Process to slice.

In large skillet over medium-high heat, add half of pork mixture. Cook 4 to 5 minutes, or until pork is no longer pink, stirring occasionally. Continue to cook and stir until liquid evaporates. Remove from skillet. Repeat with remaining pork.

Add remaining 1 teaspoon sesame oil to skillet. Add bell pepper, celery, and onions. Cook 3 to 4 minutes, or until crisp-tender, stirring occasionally.

In small bowl, mix broth and cornstarch. Add to vegetables and bring to a boil. Add pork. Cook 1 minute, or until thick and bubbly. Serve over hot cooked rice or Chinese noodles, if desired.

Yield: 8 servings.

Per Serving: About 140 cal, 19 g pro, 5 g carb, 4.5 g total fat, 1 g sat fat, 45 mg chol, 650 mg sod.

# CHICKEN FAJITAS

Position multipurpose blade in work bowl. With processor running, add garlic, jalapeno, and lime peel, if desired, through small feed tube. Process until finely chopped, about 5 seconds. Add lime juice, oil, and chili powder. Process until mixed, about 5 seconds.

Exchange multipurpose blade for 4 mm slicing disc in work bowl. Add chicken. Process to slice. Remove to shallow dish or large resealable food storage plastic bag; coat chicken with marinade. Refrigerate for 1 hour.

Meanwhile, wash processor. Position 4 mm slicing disc in work bowl. Add bell peppers and onion. Process to slice.

Heat large skillet over medium-high heat. Add chicken mixture. Cook 3 to 6 minutes, or until chicken is no longer pink, stirring occasionally. With slotted spoon, remove from skillet and keep warm. Add peppers and onions to juices in skillet. Cook 3 to 4 minutes, or until crisp-tender, stirring occasionally. Serve chicken and vegetables in tortillas. Top with sour cream, if desired.

Yield: 6 servings.

Per Serving: About 360 cal, 25 g pro, 34 g carb, 14 g total fat, 3 g sat fat, 55 mg chol, 290 mg sod.

- 2 cloves garlic
- 1 jalapeno pepper, cut into quarters and seeded
- 1 (½-inch) strip lime peel, if desired
- ¼ cup fresh lime juice
- 2 tablespoons vegetable oil
- 1–½ teaspoons chili powder
- 1 package (1¼ lb) boneless skinless chicken breast halves, frozen for 1 to 1½ hours
- 1 medium red bell pepper, cut into halves lengthwise and seeded
- 1 medium green bell pepper, cut into halves lengthwise and seeded
- 1 large onion, cut into halves lengthwise
- 6 (7 to 9-inch) flour tortillas, heated according to package
- Sour cream, if desired

# INDIVIDUAL PIZZAS

## CRUST

- 2 cups water
- $\frac{1}{4}$  cup olive oil
- 2 packages active dry yeast
- 2 ounces fresh Parmesan cheese, cut into 1-inch pieces
- 6 cups all-purpose flour
- 1 tablespoon sugar
- $1\frac{1}{2}$  teaspoons salt
- 1 teaspoon dried basil, if desired
- Olive oil
- Cornmeal

## SAUCE

- $1\frac{1}{2}$ –2 cups prepared pizza, Alfredo, barbecue, or other favorite sauce

Continued...

In small saucepan, add water and  $\frac{1}{4}$  cup oil. Heat over low heat until warm, 105° F to 115° F. Stir in yeast to dissolve. Set aside.

Position multipurpose blade in work bowl. With processor running, add cheese to small feed tube. Process until chopped, 8 to 10 seconds.

Exchange multipurpose blade for dough blade in work bowl. Add flour, sugar, salt, and basil, if desired. Process until mixed, 4 to 8 seconds. With processor running, slowly add yeast mixture through small feed tube. Process  $1\frac{1}{4}$  to  $1\frac{3}{4}$  minutes; dough will form a slightly sticky ball.

Remove dough to greased bowl, turning dough to grease all sides. Cover; let rise in warm place until double in size, about 30 to 45 minutes.

Punch dough down. Shape into 12 rounds, about  $\frac{1}{4}$ -inch thick and 7 inches in diameter. Brush crusts lightly with olive oil, if desired. Grease several large baking sheets with olive oil and sprinkle lightly with cornmeal. Top each crust with about 2 tablespoons sauce,  $\frac{1}{2}$  cup meat and/or vegetables, and 3 tablespoons cheese. Bake at 425° F for 15 to 20 minutes, or until crust is golden brown, toppings are hot, and cheese is melted and lightly browned.

Continued...

Yield: 12 servings (1 pizza per serving).

Tips: Prepare crusts, sauces, and toppings, and let individuals assemble their own pizzas.

Pizza crusts may be shaped in advance and frozen. To serve, place frozen crusts on greased, cornmeal-dusted baking sheets. Thaw 15 to 20 minutes. Top and bake as directed.

Per Serving: About 460 cal, 20 g pro, 52 g carb, 19 g total fat, 7 g sat fat, 40 mg chol, 970 mg sod.

## TOPPING

- 6–7 cups cooked sausage or ground beef, sliced pepperoni, Canadian bacon, ham, shrimp, cooked chicken, roasted peppers, fresh mushrooms, olives, onion, roasted garlic, fresh basil leaves, roma tomato slices, artichoke hearts, capers, or other favorite topping
- 1½ pounds shredded mozzarella, provolone, Cheddar, Parmesan, or other favorite cheese

# LAYERED EGGPLANT AND ROASTED RED PEPPER CASSEROLE

- 1 *medium (about 1½ lb.) eggplant*
- 3 *tablespoons olive oil*
- 4 *ounces mozzarella cheese, chilled*
- 2 *ounces Parmesan cheese, room temperature*
- 1 *cup ricotta cheese*
- 1 *egg*
- ¼ *teaspoon salt*
- ¼ *teaspoon black pepper*
- 2 *cups prepared tomato basil pasta sauce, divided*
- 1 *jar (7 oz.) roasted red peppers, well drained*

Position chef's bowl and 4 mm slicing disc in work bowl. Cut eggplant into 2½-inch lengths to fit feed tube. Process to slice. Remove to greased 15x10x1-inch pan, and arrange evenly. Drizzle with olive oil. Bake at 450°F for 8 minutes, or until slightly tender.

Meanwhile, exchange slicing disc for chef's bowl and 4 mm shredding disc. Add mozzarella cheese. Process to shred. Set aside.

Position 4 mm shredding disc in work bowl. Add Parmesan cheese. Process to shred. Exchange shredding disc for multipurpose blade. Add ricotta cheese, egg, salt, and black pepper to work bowl. Process until mixed, about 10 seconds.

Pour 1 cup pasta sauce into greased 12x8x2-inch baking pan. Layer half of eggplant on top of sauce. Top with half of red peppers and half of ricotta cheese mixture. Repeat layers of eggplant, red peppers, and ricotta cheese mixture. Top with remaining 1 cup pasta sauce and mozzarella cheese. Bake at 350°F for 30 minutes, or until eggplant is tender and casserole is bubbly.

Yield: 8 servings.

Per Serving: About 250 cal, 12 g pro, 19 g carb, 14 g total fat, 6 g sat fat, 50 mg chol, 610 mg sod.

# HERBED SALMON PATTIES

## WITH CILANTRO-CAPER MAYONNAISE

### MAYONNAISE

Position mini bowl and mini blade in work bowl. With processor running, add cilantro through small feed tube. Process until chopped, 8 to 10 seconds. Scrape sides of bowl. Add mayonnaise and capers. Process until mixed, 10 to 12 seconds. Remove to small bowl; cover and refrigerate.

### PATTIES

Position multipurpose blade in work bowl. Add bread. Process until fine crumbs form, 20 to 25 seconds. Remove to small bowl. Set aside.

With processor running, add tarragon, lemon peel, and onions through small feed tube. Process until chopped, 5 to 8 seconds. Scrape sides of bowl. Add celery. Pulse 2 to 3 times, about 2 seconds each time, or until chopped. Add egg, lemon juice, salt, pepper, and  $\frac{3}{4}$  cup bread crumbs. Pulse 2 to 3 times, about 2 seconds each time, or until mixed. Add salmon. Pulse 5 to 6 times, about 2 seconds each time, or just until mixed.

Shape into 6 patties,  $\frac{1}{2}$ -inch thick. Coat both sides of patties with remaining  $\frac{1}{4}$  cups bread crumbs and press into patties.

In large skillet over medium heat, heat 1 tablespoon oil and 1 tablespoon butter until hot. Add patties in batches, if necessary. Cook 5 to 6 minutes per side, or until golden brown, turning once. Add additional oil and butter if necessary. Serve with Cilantro-Caper Mayonnaise.

Yield: 6 servings.

Tip: Mayonnaise and uncooked patties may be made and refrigerated up to 1 day in advance. Cook patties just before serving.

Per Serving: About 400 cal, 28 g pro, 7 g carb, 28 g total fat, 5 g sat fat, 120 mg chol, 390 mg sod.

### MAYONNAISE

- 3 *tablespoons lightly packed fresh cilantro leaves*
- $\frac{1}{2}$  *cup mayonnaise or salad dressing*
- 1 *tablespoon capers, drained*

### PATTIES

- 2 *cups French, Italian or sour dough bread cubes, divided*
  - 1 *tablespoon fresh tarragon leaves*
  - 2 *strips lemon peel, yellow portion only*
  - 3 *green onions, cut into 1-inch pieces*
  - 1 *rib celery, cut into 1-inch pieces*
  - 1 *egg, beaten*
  - 1 *tablespoon lemon juice*
  - $\frac{1}{4}$  *teaspoon salt*
  - $\frac{1}{8}$  *teaspoon black pepper*
  - $1\frac{1}{2}$  *fresh salmon fillets\*, grilled or broiled, and skin removed*
  - 1–2 *tablespoons olive oil*
  - 1–2 *tablespoons butter or margarine*
- \* Three, 7-ounce cans salmon, drained, may be substituted, if desired.

# CHICKEN SATAY

## WITH PEANUT SAUCE

### CHICKEN

- 4 *cloves garlic*
- 2 *teaspoons coarsely chopped gingerroot*
- $\frac{1}{2}$  *cup soy sauce*
- 3 *tablespoons peanut or vegetable oil, divided*
- 2 *teaspoons brown sugar*
- 2 *pounds chicken breast tenders*

### SAUCE

- $\frac{3}{4}$  *cup coconut milk*
- $\frac{2}{3}$  *cup peanut butter*
- $\frac{1}{4}$  *cup soy sauce*
- $\frac{3}{4}$ –1 *teaspoon red curry paste*

### CHICKEN

Position multipurpose blade in work bowl. With processor running, add garlic and gingerroot through small feed tube. Process until chopped, 5 to 10 seconds. Add soy sauce, 2 tablespoons oil, and brown sugar. Process until blended and sugar dissolves, 15 to 20 seconds. Remove to plastic resealable food storage bag or shallow dish. Add chicken; toss to coat. Marinate  $\frac{1}{2}$  hour at room temperature or at least 2 hours in refrigerator. Remove chicken from marinade, reserving marinade.

Thread chicken tenders on soaked wooden or oiled metal skewers. Grill over medium-hot coals or broil on oiled broiler pan 4 to 6 inches from heat for 12 to 16 minutes, or until thoroughly cooked, turning once. Brush with any remaining marinade once during cooking, if desired. Serve with warm or room temperature Peanut Sauce.

### SAUCE

Position multipurpose blade in work bowl. Add all ingredients. Process until blended, 5 to 10 seconds.

Yield: 8 servings.

Per Serving: About 250 cal, 24 g pro, 5 g carb, 16 g total fat, 3.5 g sat fat, 45 mg chol, 1070 mg sod.

# WHEAT BOULES

Combine milk, water,  $\frac{1}{4}$  cup butter, and honey in small saucepan. Heat over low heat until warm, 105° F to 115° F. Stir in yeast to dissolve. Set aside.

Position dough blade in work bowl. Add all-purpose flour, whole wheat flour, walnuts,  $\frac{1}{4}$  cup wheat germ, and salt. Process until mixed, 10 to 12 seconds. With processor running, slowly add yeast mixture through small feed tube. Process 1 to 1 $\frac{1}{4}$  minutes; dough will form a slightly sticky ball.

Remove dough to greased bowl, turning dough to grease all sides. Cover; let rise in warm place until double in size, about 45 to 60 minutes.

Punch dough down. On greased baking sheet, form two 6 to 6 $\frac{1}{2}$ -inch balls\*. Make 3 shallow slashes across tops. Cover; let rise in warm place until double in size, about 30 to 45 minutes. If desired, brush with melted butter and sprinkle with wheat germ.

Bake at 375° F for 30 to 40 minutes, or until loaves are brown and sound hollow when tapped. Cool on wire rack.

Yield: 24 servings (12 slices per boule).

Per Serving: About 150 cal, 4 g pro, 24 g carb, 4 g total fat, 1.5 g sat fat, 5 mg chol, 105 mg sod.

\*Dough may be shaped into loaves and placed in two greased 8 $\frac{1}{2}$ x4 $\frac{1}{2}$ x2 $\frac{1}{2}$ -inch loaf pans.

- 1 cup milk
- $\frac{2}{3}$  cup water
- $\frac{1}{4}$  cup butter or margarine
- $\frac{1}{3}$  cup honey
- 2 packages active dry yeast
- 3 cups all-purpose flour
- 2 cups whole wheat flour
- $\frac{1}{2}$  cup coarsely chopped walnuts
- $\frac{1}{4}$  cup wheat germ
- 1 teaspoon salt
- Melted butter, if desired
- Wheat germ, if desired

# SUNDAY DINNER ROLLS

- 1½ cups milk
- ½ cup water
- ¼ cup butter or margarine
- 2 packages active dry yeast
- 5½ cups all-purpose flour
- 1 tablespoon sugar
- 2 teaspoons salt
- Melted butter or beaten egg,  
if desired*

Combine milk, water, and ¼ cup butter in small saucepan. Heat over low heat until warm, 105° F to 115° F. Stir in yeast to dissolve.

Position dough blade in work bowl. Add flour, sugar, and salt. Process until mixed, 4 to 5 seconds. With processor running, slowly add yeast mixture through small feed tube. Process 1 to 1¼ minutes; dough will form a slightly sticky ball.

Remove dough to greased bowl, turning dough to grease all sides. Cover, let rise in warm place until double in size, about 45 to 60 minutes.

Punch dough down. Divide into 30 equal-sized pieces. Shape each into a smooth ball; place 1 inch apart on greased baking sheets. Brush with melted butter or egg, if desired. Cover; let rise in a warm place until double, about 45 to 60 minutes.

Bake at 375° F for 15 to 20 minutes, or until rolls are deep golden brown and sound hollow when tapped. Cool on rack.

Yield: 30 servings (1 roll per serving).

Per Serving: About 100 cal, 3 g pro, 18 g carb, 2 g total fat, 1 g sat fat, 5 mg chol, 160 mg sod.

**VARIATION: CLOVER LEAF ROLLS**

Divide dough into 30 equal-sized balls. Divide each ball into 3 smaller balls; place the 3 balls into a greased muffin cup. Repeat with remaining balls. Brush with melted butter, if desired. Proof and bake as directed above.

Yield: 30 servings (1 roll per serving).

Per Serving: About 100 cal, 3 g pro, 18 g carb, 2 g total fat, 1 g sat fat, 5 mg chol, 160 mg sod.

**VARIATION: CRESCENT-SHAPED ROLLS**

Divide dough into thirds. Roll  $\frac{1}{3}$  of dough into  $\frac{1}{4}$ -inch thick circle. Spread with 1 tablespoon softened butter. Cut into 12 wedges. Roll each wedge from wide end to pointed end; bend ends inward slightly to shape. Brush with melted butter or egg, if desired. Place on greased baking sheets. Repeat twice with remaining dough. Proof and bake as directed above.

Yield: 36 servings (1 roll per serving).

Per Serving: About 90 cal, 3 g pro, 15 g carb, 2.5 g total fat, 1.5 g sat fat, 5 mg chol, 135 mg sod.

# WHITE BREAD

- 1½ cups water*
- ½ cup milk*
- ¼ cup butter or margarine*
- 2 packages active dry yeast*
- 6 cups all-purpose flour*
- 2 tablespoons sugar*
- 2 teaspoons salt*

Combine water, milk, and butter in small saucepan. Heat over low heat until warm, 105°F to 115°F. Stir in yeast to dissolve. Set aside.

Position dough blade in work bowl. Add flour, sugar, and salt. Process until mixed; 4 to 5 seconds. With processor running, slowly add yeast mixture through small feed tube.

Process

1 to 1¼ minutes; dough will form a slightly sticky ball.

Remove dough to greased bowl, turning dough to grease all sides. Cover; let rise in warm place until double in size, about 45 to 60 minutes.

Punch dough down. Shape into 2 loaves, and place in greased 8½x4½x2½-inch loaf pans. Cover; let rise in warm place until double in size, about 30 to 45 minutes.

Bake at 375°F for 35 to 40 minutes, or until loaves are deep golden brown and sound hollow when tapped. Remove loaves from pans immediately. Cool on rack.

Yield: 24 servings (12 slices per loaf).

Per Servings: About 130 cal, 4 g pro, 24 g carb, 2.5 g total fat, 1.5 g sat fat, 5 mg chol, 200 mg sod.

**VARIATION: CINNAMON BREAD**

After first rising, divide dough into 2 pieces. Roll out one piece of dough into a 15x9-inch rectangle. Spread with 1 tablespoon soft butter or margarine. Sprinkle with 3 tablespoons sugar and 1 teaspoon cinnamon. Starting at short end, roll firmly to form loaf. Pinch to seal ends and bottom seam. Place seam side down in 8½x4½x2½-inch greased loaf pan. Repeat with remaining dough. Proceed as directed for white bread.

Yield: 24 servings (12 slices per loaf).

Per Serving: About 150 cal, 4 g pro, 27 g carb, 3.5 g total fat, 2 g sat fat, 10 mg chol, 200 mg sod.

**VARIATION: PARMESAN PEPPER BREAD**

After first rising, divide dough into 2 pieces. Roll out one piece of dough into a 15x9-inch rectangle. Spread with 1 tablespoon soft butter or margarine. Sprinkle with ⅓ cup freshly grated Parmesan cheese and ½ teaspoon coarsely ground black pepper. Starting at short end, roll firmly to form loaf. Pinch to seal ends and bottom seam. Place seam side down in 8½x4½x2½-inch greased loaf pan. Repeat with remaining dough. Proceed as directed for white bread.

Yield: 24 servings (12 slices per loaf).

Per Serving: About 150 cal, 5 g pro, 24 g carb, 4 g total fat, 2.5 g sat fat, 10 mg chol, 250 mg sod.

# CRANBERRY-WALNUT SCONES

- 4 cups all-purpose flour
- 4 teaspoons baking powder
- $\frac{1}{2}$  teaspoon cinnamon
- $\frac{1}{4}$  teaspoon nutmeg
- $\frac{1}{2}$  teaspoon salt
- 4 tablespoons sugar, divided
- $\frac{2}{3}$  cup cold butter or margarine, cut into  $\frac{1}{2}$ -inch pieces
- 1 egg
- $1\frac{1}{3}$  cups whipping cream
- 1 cup dried cranberries
- $\frac{3}{4}$  cup walnut halves or pieces

Position multipurpose blade in work bowl. Add flour, baking powder, cinnamon, nutmeg, salt, and 3 tablespoons sugar. Process until thoroughly mixed, about 10 seconds. Add butter. Pulse 5 times, about 2 seconds each time, or until mixture is crumbly.

In small bowl, combine egg and whipping cream. Pour 1 cup of cream mixture over flour mixture in work bowl. Pulse 5 times, about 2 seconds each time. Sprinkle cranberries and nuts over flour mixture. Pour remaining cream mixture over nuts. Pulse 5 to 6 times, about 2 seconds each time, or until dry ingredients are moistened.

Turn onto lightly floured surface. Shape into large ball until dough sticks together. Pat into two 7-inch circles, about 1-inch thick. Sprinkle with remaining 1 tablespoon sugar evenly divided between circles. Cut each into 8 wedges. Place on greased baking sheet, separating pieces slightly. Bake at 400°F for 16 to 20 minutes, or until light golden brown and firm when tapped on top. Serve warm.

Yield: 16 scones (1 scone per serving).

Per Serving: About 310 cal, 5 g pro, 34 g carb, 18 g total fat, 9 g sat fat, 60 mg chol, 210 mg sod.

# BAKING POWDER BISCUITS

Position multipurpose blade in work bowl. Add flour, baking powder, and salt. Process until well mixed, about 10 seconds. Add shortening. Pulse 5 to 6 times, about 1 second each time, or until mixture is crumbly. Add milk. Pulse 5 to 6 times, about 1 second each time, or until dry ingredients are moistened. Mixture will not form a ball; do not overmix.

Place dough on floured surface. Pat or roll to ½-inch thick. Cut with floured 2-inch round cutter. If desired, gently re-roll dough pieces once to cut 2 to 3 additional biscuits. Place on ungreased baking sheet. Brush with melted butter, if desired. Bake at 450°F for 8 to 10 minutes, or until light golden brown.

Yield: 14 biscuits (1 biscuit per serving).

Per Serving: About 150 cal, 3 g pro, 18 g carb, 7 g total fat, 2 g sat fat, 0 mg chol, 270 mg sod.

- 2⅔ cups all-purpose flour*
- 4 teaspoons baking powder*
- ¾ teaspoon salt*
- ½ cup shortening*
- ¾ cup milk*
- 2 tablespoons melted butter, if desired*

# INDIVIDUAL CRANBERRY PEAR CRISPS

## TOPPING

- $\frac{1}{3}$  cup all-purpose flour
- $\frac{1}{3}$  cup packed brown sugar
- 1 teaspoon cinnamon
- $\frac{1}{4}$  teaspoon salt
- $\frac{1}{3}$  cup butter or margarine, cut into chunks
- 1 cup rolled oats

## FRUIT

- $\frac{3}{4}$  cup granulated sugar
- 1 tablespoon all-purpose flour
- $1\frac{1}{2}$  cups fresh or frozen cranberries
- 4 large pears, peeled, cut into halves, and cored

Position multipurpose blade in work bowl. Add flour, brown sugar, cinnamon, and salt. Process until blended, about 3 seconds. Add butter. Pulse 2 to 3 times, about 5 seconds each time, or until crumbly. Add oats. Pulse 2 times, about 2 seconds each time, or until mixed. Remove to medium mixing bowl. Set aside.

Position multipurpose blade in work bowl. Add granulated sugar, flour, and cranberries. Pulse 2 to 3 times, about 2 seconds each time, or until coarsely chopped. Exchange multipurpose blade for 4 mm slicing disc. Add pears. Process to slice. Remove to large mixing bowl; toss to mix.

Divide pear mixture evenly among eight, 10-ounce buttered ramekins or custard cups. Add topping, dividing evenly among ramekins. Place ramekins on large baking sheet. Bake at 350° F for 45 to 55 minutes, or until pears are tender and topping is golden brown. Serve with ice cream, if desired.

Yield: 8 servings.

Per Serving: About 320 cal, 3 g pro, 60 g carb, 9 g total fat, 5 g sat fat, 20 mg chol, 80 mg sod.

## VARIATION: INDIVIDUAL CRANBERRY APPLE CRISPS

Substitute 4 apples for pears.

Yield: 8 servings.

Per Serving: About 300 cal, 3 g pro, 55 g carb, 9 g total fat, 5 g sat fat, 20 mg chol, 75 mg sod.

# VELVETY SOUR CREAM CHEESECAKE

Position multipurpose blade in work bowl. Add crackers. Pulse 4 to 5 times, 6 to 7 seconds each time, or until fine crumbs. With processor running, slowly add butter through small feed tube. Process until combined, 10 to 15 seconds. Press in bottom and 1½ inches up sides of 10-inch springform pan. Bake at 350°F for 8 to 10 minutes, or until set. Cool.

Wipe out work bowl. Position multipurpose blade in work bowl. Add eggs. Process until blended, about 3 seconds. Add remaining ingredients. Process until smooth and blended, about 15 seconds, scraping sides of bowl if necessary.

Pour into crust. Bake at 350°F for 50 to 60 minutes, or until edges are set and center is soft-set. Cool 1 to 2 hours on rack. Refrigerate at least 4 hours. Remove sides of pan to slice. If desired, serve with favorite fruit coulis, pie filling, or chocolate or fruit sauce.

Yield: 16 servings.

Per Serving: About 370 cal, 6 g pro, 26 g carb, 28 g total fat, 18 g sat fat, 110 mg chol, 290 mg sod.

## CRUST

30 squares (2½ in. each) graham crackers, broken

½ cup butter or margarine, melted

## FILLING

3 eggs

3 packages (8 oz. each) cream cheese, softened

2 cups sour cream

1 cup sugar

¼ teaspoon salt

2 teaspoons vanilla

# FRESH FRUIT TART

## CRUST

- 1 *cup all-purpose flour*
- 2 *teaspoons sugar*
- $\frac{1}{4}$  *teaspoon salt*
- $\frac{1}{4}$  *cup cold butter, cut into 1-inch pieces*
- 1 *tablespoon cold shortening*
- 1 *egg yolk*
- 2 *tablespoons ice water*
- 1 *teaspoon lemon juice*
- 1 *egg, blended with 1 tablespoon water*

## FILLING

- $\frac{1}{4}$  *cup sugar*
- 1 *tablespoon cornstarch*
- $\frac{1}{8}$  *teaspoon salt*
- $\frac{3}{4}$  *cup half-and-half*
- 2 *egg yolks, beaten*
- $\frac{1}{2}$  *teaspoon vanilla*

Continued...

Position multipurpose blade in work bowl. Add flour, sugar, and salt. Process until mixed, about 2 seconds. Add butter and shortening. Pulse 3 to 4 times, 2 to 3 seconds each time, or until crumbly. In small bowl, blend egg yolk, 2 tablespoons water, and lemon juice. Sprinkle evenly over flour mixture. Pulse 1 to 3 times, 2 to 3 seconds each time, or until dry ingredients are moistened and crumbly.

On lightly floured surface, shape into a ball. Roll into a circle 2 inches larger than inverted 10-inch tart pan. Fit into tart pan, being careful not to stretch dough. Trim edges of crust. Prick shell thoroughly with fork. Bake at 425° F for 8 to 12 minutes, or until light golden brown. Brush shell with egg and water mixture to seal holes. Bake for 1 minute to set egg. Cool completely.

In small saucepan over medium heat, combine sugar, cornstarch, and salt. Add half-and-half and egg yolks. Cook and stir until very thick. Remove from heat. Add vanilla. Whisk until smooth. Cool completely.

Continued...

Meanwhile, wash processor. Position chef's bowl and 4 mm slicing disc in work bowl. Add strawberries. Process to slice. Set aside. Position 4 mm slicing disc in work bowl. Add peach. Process to slice.

Spread custard mixture in shell. Arrange sliced fruit on custard. Carefully brush with melted jelly to cover fruit completely. Refrigerate at least 30 minutes before serving.

Yield: 8 servings.

Tip: Tart is best served the same day it is made.

Per Serving: About 230 cal, 4 g pro, 27 g carb, 12 g total fat, 6 g sat fat, 125 mg chol, 130 mg sod.

## TOPPING

- 1 cup fresh strawberries, hulled
- 1 medium peach, peeled, cut into halves, and pit removed
- 2 tablespoons apple jelly, melted

# APPLE PIE

- 2 *pastry crusts (see page 87)*
- 2 *tablespoons crystallized ginger, if desired*
- $\frac{1}{3}$  *cup granulated sugar*
- $\frac{1}{4}$  *cup packed brown sugar*
- 3 *tablespoons all-purpose flour*
- 1 *teaspoon cinnamon*
- $\frac{1}{8}$  *teaspoon nutmeg*
- 6 *medium to large crisp apples (Gala or Rome), peeled, cored, and cut into halves lengthwise*
- 1 *tablespoon butter or margarine, cut up*
- 2 *teaspoons milk, if desired*
- 1 *tablespoon granulated sugar, if desired*

Prepare pastry crust as directed in recipe. Fit one crust into 9-inch pie plate. Cover both halves of crust with plastic wrap. Set aside.

Position multipurpose blade in work bowl. With processor running, add ginger through small feed tube. Process until chopped, 10 to 15 seconds. Add  $\frac{1}{3}$  cup granulated sugar, brown sugar, flour, cinnamon, and nutmeg. Process until mixed, 2 to 3 seconds.

Exchange multipurpose blade for 4 mm slicing disc in work bowl. Add apples, cutting to fit feed tube if necessary. Process to slice. Remove apples and sugar mixture to large mixing bowl. Stir gently to coat. Add mixture to unbaked pie shell. Dot with butter.

Cover with top crust. Seal edge and flute. If desired, brush with milk and sprinkle with sugar. Cut 6 to 8 slits in top crust, allowing steam to escape. Bake at 425°F for 60 to 70 minutes, or until crust is golden brown and filling begins to bubble in center. Cover pie with foil, if necessary, to prevent over-browning. Cool on rack.

Yield: 8 servings.

Per Serving: About 380 cal, 4 g pro, 52 g carb, 18 g total fat, 7 g sat fat, 15 mg chol, 220 mg sod.

# PASTRY CRUST

Position multipurpose blade in work bowl. Add flour and salt. Process until mixed, about 2 seconds. Add shortening and butter. Pulse 3 to 4 times, 2 to 3 seconds each time, or until crumbly. Sprinkle minimum amount of water evenly over mixture. Pulse 1 to 3 times, 2 to 3 seconds each time, or until mixture pulls away from sides of bowl and dry ingredients are moistened. Add additional water if necessary.

On lightly floured surface, shape into a ball (2 balls for 2-crust pie). Roll each ball into a circle 2 inches larger than inverted pie plate. Fit into pie plate. Proceed as directed in pie recipe.

To bake single crust shell, flute edges of crust. Prick shell thoroughly with fork. Bake at 425°F for 9 to 12 minutes, or until light golden brown. To bake 2-crust pie, follow directions in pie recipe.

Yield: 1 pie (8 servings).

Tip: To make 4 crusts, double 2-crust recipe. Roll out extra crusts and place in pie plates. Store in airtight container and freeze.

Per Serving (one crust): About 120 cal, 2 g pro, 11 g carb, 8 g total fat, 2.5 g sat fat, 5 mg chol, 75 mg sod.

Per Serving (two crusts): About 260 cal, 4 g pro, 23 g carb, 17 g total fat, 6 g sat fat, 10 mg chol, 220 mg sod.

## ONE CRUST

- 1 cup all-purpose flour
- $\frac{1}{4}$  teaspoon salt
- $\frac{1}{4}$  cup cold shortening
- 1 tablespoon cold butter or margarine, cut up
- 2–4 tablespoons ice water

## TWO CRUSTS

- 2 cups all-purpose flour
- $\frac{3}{4}$  teaspoon salt
- $\frac{1}{2}$  cup cold shortening
- 3 tablespoons cold butter or margarine, cut up
- 5–7 tablespoons ice water

# 3-LAYER CARROT CAKE

WITH CREAM CHEESE FROSTING

## CAKE

$1\frac{1}{2}$  pounds (8–11 medium) carrots

$2\frac{2}{3}$  cups sugar

$\frac{3}{4}$  cup vegetable oil

4 eggs

$2\frac{1}{2}$  teaspoons vanilla

3 cups all-purpose flour

$2\frac{1}{2}$  teaspoons baking soda

$\frac{3}{4}$  teaspoon salt

$2\frac{1}{2}$  teaspoons cinnamon

$\frac{1}{2}$  teaspoon nutmeg

$\frac{1}{2}$  cup golden raisins

$\frac{1}{2}$  cup flaked coconut

$\frac{3}{4}$  cup pecan halves or pieces

## CAKE

Position chef's bowl and 4 mm shredding disc in work bowl. Add carrots, cutting to fit feed tube if necessary. Process to shred. (Yield should be about 4 cups.)

Exchange chef's bowl and shredding disc for multipurpose blade in work bowl. Add sugar, oil, eggs, vanilla, and carrots. Process until thoroughly mixed, 8 to 10 seconds. Scrape sides of bowl. Process 25 to 30 seconds longer to dissolve sugar. Spread all remaining cake ingredients evenly over carrot mixture in bowl. Pulse 3 to 4 times, 2 to 3 seconds each time, or until just blended.

Pour batter evenly into 3 greased and floured 9-inch round cake pans (about  $2\frac{1}{3}$  cups batter per pan). Bake at 350° F for about 30 minutes, or until wooden pick inserted in center comes out clean. If baking on 2 racks, rearrange pans half way through. Cool in pans on rack for 10 minutes. Remove layers from pans; cool completely. Frost with Cream Cheese Frosting.

## FROSTING

Position multipurpose blade in work bowl. Add powdered sugar, cream cheese, and butter. Process until thoroughly mixed, about 20 seconds. With processor running, add vanilla and 1 teaspoon half-and-half through small feed tube. Process until mixed, about 10 seconds. With processor running, if necessary, add remaining 1 teaspoon half-and-half a little at a time until frosting is spreading consistency. Spread between cooled layers and on sides of cake. Sprinkle pecans on top of cake, if desired. Store in refrigerator.

Yield: 16 servings.

Tip: If desired, freeze individual cake layers in sealed storage containers until ready to use. Thaw and frost.

Per Serving: About 670 cal, 6 g pro, 107 g carb, 26 g total fat, 10 g sat fat, 80 mg chol, 400 mg sod.

## FROSTING

- 6<sup>1</sup>/<sub>3</sub> cups powdered sugar*
- 1 package (8 oz.) cream cheese, cut into 8 pieces*
- <sup>1</sup>/<sub>3</sub> cup butter or margarine, softened*
- 1<sup>1</sup>/<sub>4</sub> teaspoons vanilla*
- 1–2 teaspoons half-and-half or milk*
- <sup>1</sup>/<sub>3</sub> cup pecan halves or pieces, if desired*

# TROPICAL LEMON MERINGUE PIE

1 9-inch pastry crust, baked and cooled (see page 87)

## FILLING

$\frac{1}{4}$  cups sugar, divided

4 strips ( $\frac{1}{2}$ -in. each) lemon peel, yellow portion only

3 strips ( $\frac{1}{2}$ -in. each) lime peel, green portion only

$\frac{1}{4}$  cup cornstarch

$\frac{1}{8}$  teaspoon salt

$\frac{1}{3}$  cup fresh lemon juice

3 egg yolks, beaten

$1\frac{2}{3}$  cups water

## MERINGUE

4 egg whites

$\frac{1}{2}$  teaspoon cream of tartar

$\frac{1}{8}$  teaspoon salt

$\frac{1}{3}$  cup sugar

Position mini bowl and mini blade in work bowl. With processor running, add 1 tablespoon sugar, lemon and lime peel through small feed tube. Process until peel is chopped, 5 to 10 seconds. Remove to small bowl; set aside.

Exchange mini bowl and mini blade for multipurpose blade in work bowl. Add remaining 1 cup plus 3 tablespoons sugar, cornstarch, and  $\frac{1}{8}$  teaspoon salt. Process until mixed, 5 to 8 seconds. With processor running, add lemon juice, egg yolks, and water through small feed tube. Process until blended, 3 to 5 seconds. Remove to medium saucepan. Set aside.

Wash processor. Position egg whip attachment in work bowl. Add egg whites, cream of tartar, and  $\frac{1}{8}$  teaspoon salt. Process until foamy, 20 to 25 seconds. With processor running, gradually add  $\frac{1}{3}$  cup sugar through small feed tube. Process until glossy and stiff peaks form, about 5 minutes. Set aside.

In medium saucepan over medium heat, cook and stir reserved filling mixture until very thick. Stir in reserved lemon and lime peel. Remove from heat, and pour into prepared pie crust. Spread meringue over warm filling, sealing meringue to edges of crust. Bake at 325°F about 15 minutes, or until light golden. Cool completely.

Yield: 8 servings.

Per Serving: About 320 cal, 5 g pro, 56 g carb, 9 g total fat, 3 g sat fat, 80 mg chol, 180 mg sod.

# CHOCOLATE-ORANGE MOUSSE

Position multipurpose blade in work bowl. Add chocolate chips, granulated sugar, and orange peel. Process until chocolate and peel are finely chopped, about 35 seconds. Set aside.

In small saucepan over medium heat, heat milk until very hot but not boiling. In small bowl, sprinkle gelatin over water. Let stand 10 to 15 seconds to soften. Add to hot milk. Reduce heat to medium-low. Cook and stir until gelatin dissolves.

With processor running, slowly add hot milk mixture to chocolate mixture through small feed tube. Process until smooth, 10 to 20 seconds, scraping sides of bowl if necessary. Remove to medium mixing bowl. Refrigerate about 30 minutes.

Meanwhile, wash processor. Position egg whip attachment in work bowl. Add whipping cream and powdered sugar. Process until soft peaks form, 1½ to 2 minutes. Fold into cooled chocolate mixture. Refrigerate 15 to 20 minutes to thicken. Spoon into individual dessert dishes. Refrigerate until serving.

Yield: 4 servings (½ cup per serving).

Tip: Garnish with orange twists or mandarin orange segments, if desired.

Per Serving: About 400 cal, 2 g pro, 39 g carb, 27 g total fat, 16 g sat fat, 85 mg chol, 20 mg sod.

- ½ cup semisweet chocolate chips*
- ¼ cup granulated sugar*
- 6 strips orange peel, orange portion only*
- ½ cup milk*
- 1 teaspoon unflavored gelatin*
- 1 tablespoon water*
- 1 cup whipping cream*
- ¼ cup powdered sugar*

# PECAN SHORTBREAD BARS

## CRUST

- 2 cups all-purpose flour
- $\frac{2}{3}$  cup powdered sugar
- $\frac{1}{8}$  teaspoon salt
- 1 strip orange peel, orange portion only
- 1 cup butter or margarine, cut into 1-inch pieces

## FILLING

- $\frac{2}{3}$  cup butter or margarine
- $\frac{1}{3}$  cup packed brown sugar
- $\frac{1}{4}$  cup maple syrup
- $\frac{1}{8}$  teaspoon salt
- 1 teaspoon vanilla
- 1 cup pecan pieces

Position multipurpose blade in work bowl. Add flour, powdered sugar,  $\frac{1}{8}$  teaspoon salt, and orange peel. Process until peel is finely chopped, 10 to 15 seconds. Add 1 cup butter. Process until soft dough forms, 40 to 45 seconds. Press in bottom and  $\frac{1}{2}$  inch up sides of ungreased 13x9x2-inch baking pan. Bake at 350° F for 20 to 25 minutes, or until set and light golden. Cool completely.

Meanwhile, in medium saucepan over medium heat, combine  $\frac{2}{3}$  cup butter, brown sugar, maple syrup, and  $\frac{1}{8}$  teaspoon salt. Cook, stirring constantly, until mixture boils. Boil 1 minute without stirring. Remove from heat. Add vanilla and pecans. Stir until blended. Pour into prepared crust and spread evenly. Let cool completely.

Yield: 32 bars (1 bar per serving).

Per Serving: About 160 cal, 1 g pro, 13 g carb, 12 g total fat, 6 g sat fat, 25 mg chol, 20 mg sod.

**KitchenAid**<sup>®</sup>  
PRO LINE™ SERIES

# WARRANTY AND SERVICE INFORMATION

## Warranty Information Section Contents

Warranty for the U.S. ....	94
Warranty for Puerto Rico .....	95
Arranging for Hassle-Free Replacement .....	95
Ordering Accessories & Replacement Parts .....	96
Arranging for Service After the Warranty Expires .....	96
Arranging for Service Outside the U.S. & Puerto Rico .....	97

FOOD PROCESSOR **WARRANTY**  
 FOR THE **50 UNITED STATES**  
 AND DISTRICT OF COLUMBIA

This warranty extends to the purchaser and any succeeding owner for PRO LINE™ Series Food Processors operated in the 50 United States and District of Columbia.

<b>Length of Warranty:</b>	<b>KitchenAid Will Pay For Your Choice of:</b>	<b>KitchenAid Will Not Pay For:</b>
<p>Two Year Full Warranty for Household Use, from date of purchase.</p>	 <p>Hassle-Free Replacement of your Food Processor. See "Arranging for Hassle-Free Replacement" for details, or call the KitchenAid Customer Satisfaction Center toll-free at <b>1-800-541-6390</b>.                      OR                      The replacement parts and repair labor costs to correct defects in materials and workmanship. Service must be provided by an Authorized KitchenAid Service Center. See the KitchenAid® PRO LINE™ Series Food Processor Warranty for Puerto Rico for details on how to arrange for service.</p>	<p>A. Repairs when the Food Processor is used in other than normal single family home use.                      B. Damage resulting from accident, alteration, misuse or abuse.                      C. Any shipping or handling costs to deliver your Food Processor to an Authorized Service Center.                      D. Replacement parts or repair labor costs for Food Processors operated outside the 50 United States and District of Columbia.</p>

**KITCHENAID DOES NOT ASSUME ANY RESPONSIBILITY FOR INCIDENTAL OR CONSEQUENTIAL DAMAGES.** Some states do not allow the exclusion or limitation of incidental or consequential damages, so this exclusion may not apply to you. This warranty gives you specific legal rights and you may also have other rights which vary from state to state.

# FOOD PROCESSOR **WARRANTY** FOR **PUERTO RICO**

A limited two year warranty extends to the purchaser and any succeeding owner for PRO LINE™ Series Food Processors operated in Puerto Rico. During the warranty period, all service must be handled by an Authorized KitchenAid Service Center.

Please bring the Food Processor, or ship it prepaid and insured, to the nearest Authorized Service Center. Call toll-free **1-800-541-6390** Monday through Friday, 8 a.m. to 8 p.m. (Eastern Time), or Saturday, 10 a.m. to 5 p.m. to learn the location of a Service Center near you. Your repaired Food Processor will be returned to you prepaid and insured.

## **ARRANGING** FOR **HASSLE-FREE** REPLACEMENT

**IF YOU RESIDE IN THE 50 UNITED STATES** and your KitchenAid® PRO LINE™ Series Food Processor should fail within two years of ownership, simply call our toll-free Customer Satisfaction Center at **1-800-541-6390** Monday through Friday, 8 a.m. to 8 p.m. (Eastern Time), or Saturday, 10 a.m. to 5 p.m. Give the consultant your complete shipping address. (No P.O. Box Numbers, please.)

When you receive your replacement PRO LINE™ Series Food Processor, use the carton and packing materials to pack-up your “failed” Food Processor. In the carton, include your name and address on a sheet of paper along with a copy of the proof of purchase (register receipt, credit card charge slip, etc.).

KitchenAid will arrange to deliver an identical or comparable replacement to your door free of charge and arrange to have your “failed” Food Processor returned to us. Your replacement unit will also be covered by our two year full warranty.

# ORDERING **ACCESSORIES** AND **REPLACEMENT** PARTS

To order accessories or replacement parts for your Food Processor, call toll-free **1-800-541-6390** Monday through Friday, 8 a.m. to 8 p.m. (Eastern Time), or Saturday, 10 a.m. to 5 p.m., or write to:

Customer Satisfaction Center, KitchenAid Portable Appliances,  
P.O. Box 218, St. Joseph, MI 49085-0218.

# ARRANGING FOR **SERVICE** AFTER THE **WARRANTY** EXPIRES

For service information, call toll-free **1-800-541-6390** Monday through Friday, 8 a.m. to 8 p.m. (Eastern Time), or Saturday, 10 a.m. to 5 p.m., or write to:

Customer Satisfaction Center, KitchenAid Portable Appliances,  
P.O. Box 218, St. Joseph, MI 49085-0218.

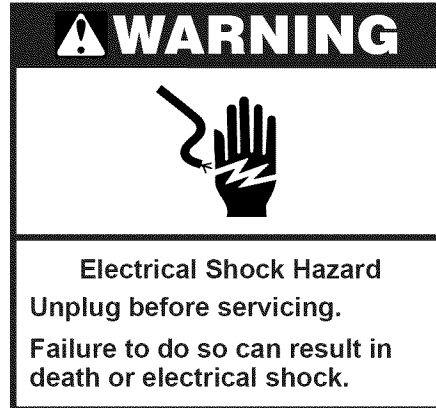

ARRANGING FOR **SERVICE** OUTSIDE  
THE **50 UNITED STATES**  
AND PUERTO RICO

Consult your local KitchenAid dealer or the store where you purchased your PRO LINE™ Series Food Processor for information on how to obtain service.



FOR THE WAY IT'S MADE.™

® Registered Trademark/™ Trademark of KitchenAid, U.S.A.  
© 2004. All rights reserved.

Specifications subject to change without notice.

dZw304

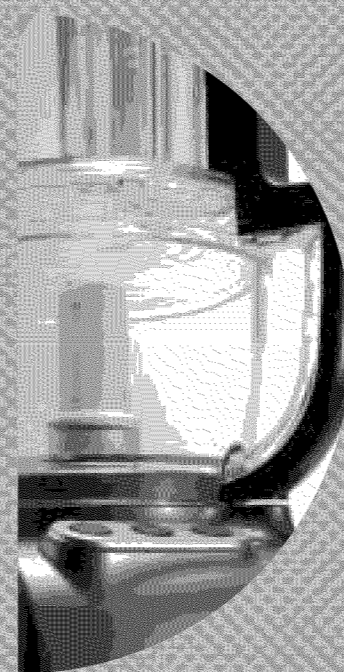

**KitchenAid**<sup>®</sup>  
PRO LINE™ SERIES

GUIDE TO  
**PROFESSIONAL**  
RESULTS

Model KPFP850 Food Processor





FOR THE WAY IT'S MADE.™

® Registered Trademark/™ Trademark of KitchenAid, U.S.A.  
© 2004. All rights reserved.

Specifications subject to change without notice.

dZw304

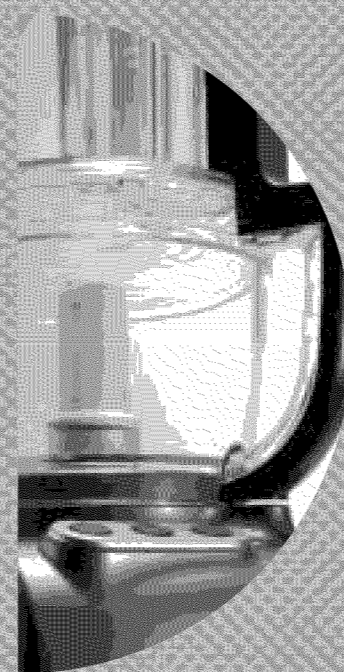

**KitchenAid®**  
PRO LINE™ SERIES

MODEL  
**KPFP850**  
FOOD PROCESSOR

**Introduction  
Section Contents**

Table of Contents .....	3
Food Processor Safety .....	5
Important Safeguards .....	6
Proof of Purchase & Registration .....	7
Electrical Requirements .....	8

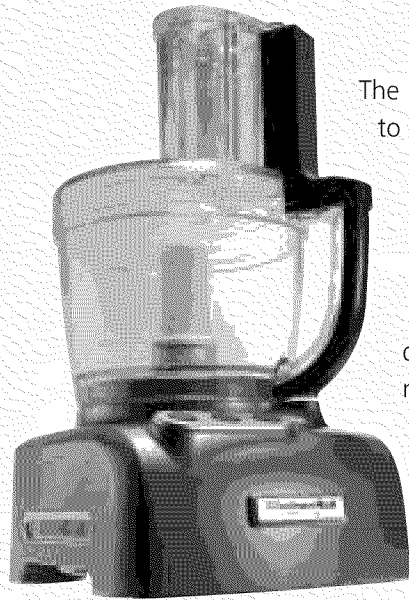

The **KitchenAid® PRO LINE™ Series Food Processor** is engineered to provide commercial quality performance. A professional 16-cup work bowl and extra-wide feed tube sit atop a rugged die-cast metal base. The powerful 1000-watt motor is designed to make quick work of the most demanding food preparation tasks. The heavy-gauge cutting blades and discs are made from the highest quality stainless steel for exceptionally clean slicing and shredding. This machine doesn't trade performance for capacity – you'll achieve extraordinary results no matter what the task.

The outstanding performance is matched by exceptional convenience. A mini bowl and mini blade transform the PRO LINE™ Series food processor into a mini-chopper, the perfect tool for finely chopping herbs, nuts, onions, and garlic. The Ultra Wide Mouth™ Feed Tube is one of the industry's largest – it will process tomatoes, cucumbers, and potatoes with a minimum of sectioning or slicing. Another great timesaver is the 13-cup chef's bowl: place it inside the work bowl, and you'll be able to slice or shred an item while keeping the work bowl clean for another ingredient.

The KitchenAid® PRO LINE™ Series: professional quality for the discriminating home chef. From the company distinguished by its legendary craftsmanship.

# TABLE OF CONTENTS

## INTRODUCTION

Introduction .....	2
Food Processor Safety .....	5
Important Safeguards .....	6
Proof of Purchase & Product Registration .....	7
Electrical Requirements .....	8

## FEATURES AND OPERATION

Food Processor Features .....	10
Preparing the Food Processor for Use	
Before First Use .....	12
Work Bowl Assembly .....	12
Multipurpose Blade & Dough Blade Assembly .....	13
Slicing & Shredding Disc Assembly .....	14
Mini Bowl Assembly .....	14
Chef's Bowl Assembly .....	15
Egg Whip Assembly & Use .....	15
Using the Food Processor	
Before Use .....	17
Food Pusher Interlock .....	17
Maximum Liquid Level .....	17
Turning the Food Processor On and Off .....	18
Using the Pulse Control .....	18
2-Piece Food Pusher .....	18
Disassembling the Food Processor .....	19
Care and Cleaning .....	21
Troubleshooting .....	22

## FOOD PROCESSING TIPS AND RECIPES

Using the Multipurpose Blade .....	24
Using a Slicing or Shredding Disc .....	26
Using the Dough Blade .....	27
Using the Egg Whip .....	28
Helpful Hints .....	29
Appetizer Recipes	
Preparation and Serving Suggestions .....	34
Crab-Stuffed Mushrooms .....	35
Sesame-Almond Crackers .....	36
Caramelized Onion Puff Pastry Squares .....	37
Hot Artichoke Dip .....	38
Camembert Salmon Dip .....	39
Chipotle Deviled Eggs .....	40
Tropical Fruit Salsa .....	41
Shrimp Dill Dip .....	42
Roasted Salsa Verde .....	43
Salad & Dressing Recipes	
White Balsamic Vinaigrette .....	44
Mediterranean Hot Chicken Salad .....	45
Citrus Dressing .....	46
Fresh Jicama Salad .....	47
Chicken Wild Rice Salad .....	48
Asian Coleslaw For A Crowd .....	49
Hot Potato Salad .....	50
Broccoli-Kohlrabi Confetti Salad .....	51

# TABLE OF CONTENTS

## Soup & Sandwich Recipes

Cheddar Broccoli Soup .....	52
Chicken Chutney Sandwich Spread .....	53
Roasted Butternut Squash Soup With Herb Pistou .....	54
Runza Pocket Sandwiches .....	55
Pan-Fried Veggie Burgers .....	56
Winter Vegetable Soup .....	57
Muffaletta Sandwiches .....	59
French Onion Soup .....	60
Creole Gumbo .....	61

## Vegetable & Side Dish Recipes

Sweet Dilled Cucumbers and Onions .....	63
Layered Eggplant and Pepper Casserole .....	64
Spring Mix Basmati Rice .....	65
Bourboned Carrots .....	66
Loaded Baked Potato Casserole .....	67

## Main Dish Recipes

Szechwan Pork .....	68
Chicken Fajitas .....	69
Individual Pizzas .....	70
Layered Eggplant and Roasted Red Pepper Casserole .....	72
Herbed Salmon Patties with Cilantro-Caper Mayonnaise .....	73
Chicken Satay with Peanut Sauce .....	74

## Bread Recipes

Wheat Boules .....	75
Sunday Dinner Rolls .....	76
White Bread .....	78
Cranberry-Walnut Scones .....	80
Baking Powder Biscuits .....	81

## Dessert Recipes

Individual Cranberry Pear Crisps .....	82
Velvety Sour Cream Cheesecake .....	83
Fresh Fruit Tart .....	84
Apple Pie .....	86
Pastry Crust .....	87
3-Layer Carrot Cake with Cream Cheese Frosting .....	88
Tropical Lemon Meringue Pie .....	90
Chocolate-Orange Mousse .....	91
Pecan Shortbread Bars .....	92

## WARRANTY AND SERVICE INFORMATION

Warranty for the 50 United States & District of Columbia .....	94
Warranty for Puerto Rico .....	95
Arranging for Hassle-Free Replacement .....	95
Ordering Accessories & Replacement Parts .....	96
Arranging for Service After the Warranty Expires .....	96
Arranging for Service Outside the 50 United States & Puerto Rico .....	97

# FOOD PROCESSOR SAFETY

## Your safety and the safety of others are very important.

We have provided many important safety messages in this manual and on your appliance. Always read and obey all safety messages.



This is the safety alert symbol.

This symbol alerts you to potential hazards that can kill or hurt you and others.

All safety messages will follow the safety alert symbol and either the word "DANGER" or "WARNING." These words mean:



**You can be killed or seriously injured if you don't immediately follow instructions.**



**You can be killed or seriously injured if you don't follow instructions.**

All safety messages will tell you what the potential hazard is, tell you how to reduce the chance of injury, and tell you what can happen if the instructions are not followed.

# IMPORTANT SAFEGUARDS

When using electrical appliances, basic safety precautions should always be followed, including the following:

1. Read all instructions and information in this instruction book and any other literature included in this packaging referring to this product before operating or using this appliance.
2. To protect against risk of electrical shock, do not put Food Processor in water or other liquids.
3. Close supervision is necessary when any appliance is used by or near children.
4. Unplug from the outlet when not in use, before putting on or taking off parts, and before cleaning.
5. Avoid contacting moving parts.
6. Do not operate any appliance with a damaged cord or plug, or after the appliance malfunctions or is dropped or damaged in any manner. Return appliance to the nearest Authorized Service Center for examination, repair, or electrical or mechanical adjustment.
7. The use of attachments not recommended or sold by the manufacturer may cause fire, electric shock, or injury.
8. Do not use outdoors.
9. Do not let cord hang over edge of table or counter.
10. Keep hands and utensils away from moving blades or discs while processing food to reduce the risk of severe injury to persons or damage to the Food Processor. A scraper may be used, but must be used only when the Food Processor is not running.
11. Blades are sharp. Handle carefully.
12. To reduce the risk of injury, never place cutting blade or discs on base without first putting bowl properly in place.
13. Be certain cover is securely locked in place before operating appliance.
14. Never feed food by hand. Always use food pusher.
15. Do not attempt to defeat the cover interlock mechanism.
16. This product is designed for household use only.

SAVE THESE INSTRUCTIONS

# PROOF OF PURCHASE

## & PRODUCT REGISTRATION

Always keep a copy of the sales receipt showing the date of purchase of your Food Processor. Proof of purchase will assure you of in-warranty service.

Before you use your Food Processor, please fill out and mail your product registration card packed with the unit. This card will enable us to contact you in the unlikely event of a product safety notification and assist us in complying with the provisions of the Consumer Product Safety Act. This card does not verify your warranty.

Please complete the following for your personal records:

Model Number: KFPF850

Serial Number \_\_\_\_\_

Date Purchased \_\_\_\_\_

Store Name \_\_\_\_\_

# ELECTRICAL REQUIREMENTS

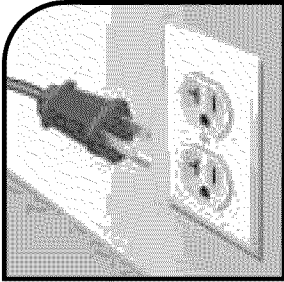

**Volts: 120 V.A.C. only.**

**Hertz: 60 Hz**

**NOTE:** This Food Processor has a 3 prong grounded plug. To reduce the risk of electrical shock, this plug will fit in an outlet only one way. If the plug does not fit in the outlet, contact a

qualified electrician. Do not modify the plug in any way.

A short power-supply cord is provided to reduce the risk resulting from becoming entangled in or tripping over a longer cord. Do not use an extension cord. If the power supply cord is too short, have a qualified electrician or serviceman install an outlet near the appliance.

## **⚠ WARNING**



### **Electrical Shock Hazard**

**Plug into a grounded 3 prong outlet.**

**Do not remove ground prong.**

**Do not use an adapter.**

**Do not use an extension cord.**

**Failure to follow these instructions can result in death, fire, or electrical shock.**

**KitchenAid®**  
PRO LINE™ SERIES

# FEATURES AND OPERATION

## Features and Operation Section Contents

Food Processor Features.....	10
Preparing for Use.....	12
Using the Food Processor.....	17
Disassembling the Food Processor.....	19
Care and Cleaning.....	21
Troubleshooting.....	22

# MODEL KPFP850 FOOD PROCESSOR FEATURES



Model KPFP850  
Food Processor

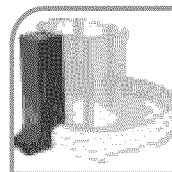

## Work Bowl Cover with Ultra Wide Mouth™ Feed Tube

One of the industry's largest feed tubes accommodates large items – like tomatoes, cucumbers, and potatoes – with a minimum of sectioning or slicing.

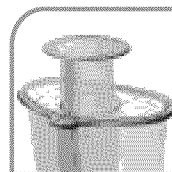

## 2-Piece Food Pusher

For smaller items, remove the small pusher from the central tube in the large pusher. The small pusher and feed tube make it easy to process herbs, nuts, single carrots and celery.

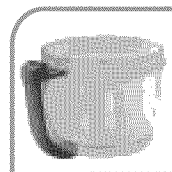

## 16-Cup Work Bowl

The tough, crystal-clear polycarbonate bowl provides capacity for the largest jobs. The bowl features a comfortable handle.

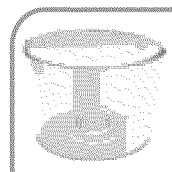

## Chef's Bowl

Place the 13-cup Chef's Bowl inside the Work Bowl, and slice or shred a food item while keeping the Work Bowl clean for another ingredient.

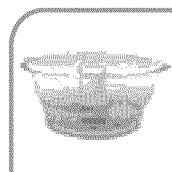

## Mini Bowl and Mini Blade

Bowl and blade are perfect for small chopping and mixing jobs. The 4½-cup bowl holds more than most standalone choppers. The mini blade is made of high quality stainless steel.

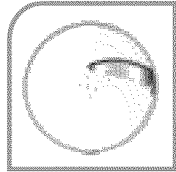

#### **Fine (2 mm) Slicing Disc**

Disc produces approximately  $\frac{1}{16}$ -inch slices of most foods, from delicate strawberries to partially frozen meats.

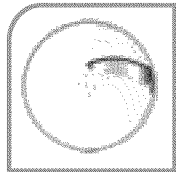

#### **Medium (4 mm) Slicing Disc**

Disc produces approximately  $\frac{1}{8}$ -inch slices of most foods.

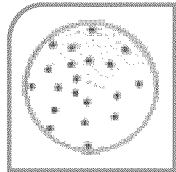

#### **Medium (4 mm) Shredding Disc**

Disc produces approximately  $\frac{1}{8}$ -inch shreds of most firm fruits, vegetables, and cheese.

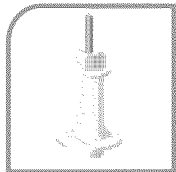

#### **Disc Stem**

Stem fits over the power shaft on the base and into the bottom of a slicing or shredding disc.

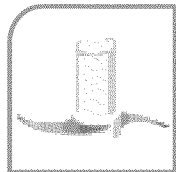

#### **Stainless Steel Multipurpose Blade**

Versatile blade chops, minces, blends, mixes, and emulsifies in a matter of seconds.

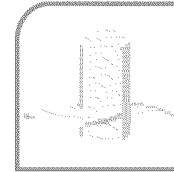

#### **Dough Blade**

The dough blade is specially designed for mixing and kneading yeast dough.

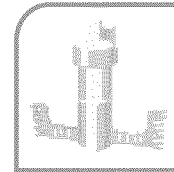

#### **Egg Whip**

The egg whip will quickly whip cream and egg whites for soft meringues, mousses, soufflés, and desserts.

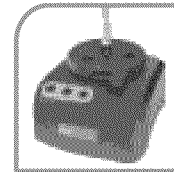

#### **Die-Cast Metal Base**

The base features the on, off, and pulse buttons along with the power shaft, which rotates the blades and discs.

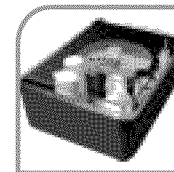

#### **Chef's Accessory Case**

Case helps protect blades, discs, and other accessories while keeping them organized and ready for use.

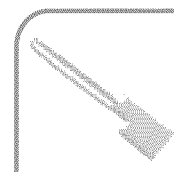

#### **Spatula**

Special shape facilitates food removal from bowls, discs, and blades.

# PREPARING THE FOOD PROCESSOR FOR USE

## Before First Use

Before using your food processor for the first time, wash the work bowl, work bowl cover, chef's bowl, mini bowl, feed tube pusher, discs, and blades either by hand or in the dishwasher (see "Care and Cleaning" on page 21).

## Work Bowl Assembly

1. Place the food processor base on a dry, level countertop with the controls facing forward. Do not plug in the unit until it is completely assembled.
2. With the handle just to the left of center, place the work bowl on the base, fitting the center opening over the power shaft.
3. Grasp the work bowl handle and turn the bowl to the right until it locks into position.



## **!** WARNING

### Cut Hazard

**Handle blades carefully.**

**Failure to do so can result in cuts.**

4. Insert the desired accessory into the work bowl. See pages 13–16 for accessory instructions.
5. Place the work bowl cover on the work bowl with the feed tube just to the left of the work bowl handle. Grasp the feed tube and turn the cover to the right until it locks into place.

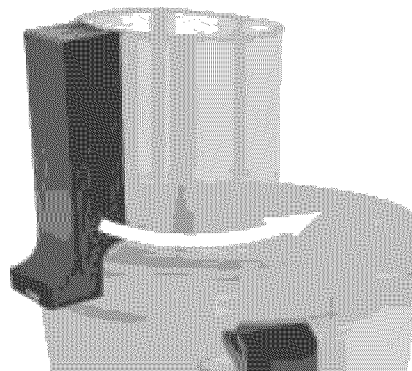

**NOTE:** Do not attach the cover to the work bowl before the work bowl is locked on the base. Damage to the work bowl may result.

6. Fit the pusher into the feed tube.

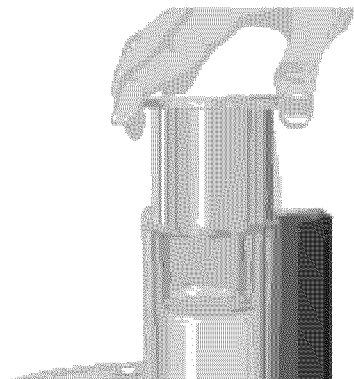

## **⚠ WARNING**



### **Electrical Shock Hazard**

**Plug into a grounded 3 prong outlet.**

**Do not remove ground prong.**

**Do not use an adapter.**

**Do not use an extension cord.**

**Failure to follow these instructions can result in death, fire, or electrical shock.**

7. Plug the food processor into a 3 prong grounded outlet.

**NOTE:** Your PRO LINE™ Series Food Processor will not operate unless the work bowl and work bowl cover are properly locked on the base, and the pusher is inserted to the maximum fill line on the feed tube.

Do not remove the work bowl from the base without first removing the work bowl cover. Damage to the work bowl may result.

### **Multipurpose Blade and Dough Blade Assembly**

Place the blade on the power shaft. Rotate the blade so it falls into place on the shaft.

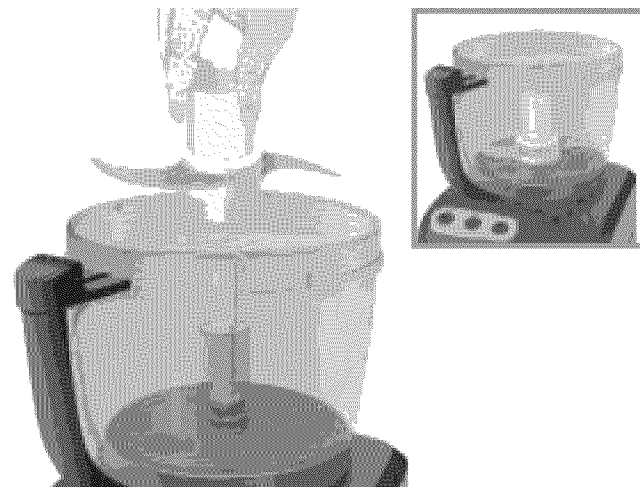

Continued...

# PREPARING THE FOOD PROCESSOR FOR USE

## Slicing and Shredding Disc Assembly

Place the disc stem on the power shaft. Fit the disc over the metal pin on the disc stem, then rotate the disc until it falls fully onto the stem.



## Mini Bowl Assembly

Place the mini bowl inside the work bowl over the power shaft. Rotate the mini bowl until it falls into place. When properly seated in the work bowl, the mini bowl cannot be rotated. Fit the mini blade on the power shaft. It may be necessary to rotate the blade until it falls into place.

The mini bowl can also be placed in the chef's bowl in a similar manner.

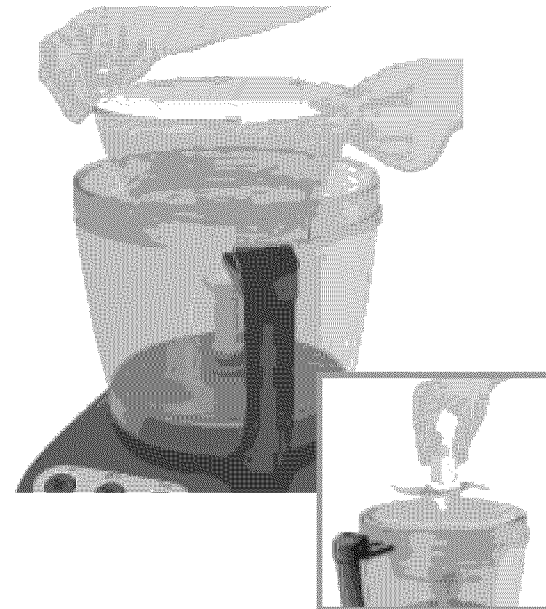

To remove the mini bowl after processing, lift the bowl using the two finger grips located along the top edge of the bowl.



### Chef's Bowl Assembly

Place the chef's bowl inside the work bowl over the power shaft. Rotate the chef's bowl until it falls into place. When properly seated in the work bowl, the chef's bowl cannot be rotated.

The chef's bowl can only be used with the slicing and shredding discs – the multipurpose blade cannot be used.

To remove the chef's bowl after processing, lift the bowl using the two finger grips located along the top edge of the bowl.

### Egg Whip Assembly and Use

The egg whip is designed to whip egg whites or heavy cream to create toppings or soft meringues. For the best results when whipping cream, use at least 1 cup of cream and no more than 2 cups at most. When whipping egg whites, use a minimum of 4 – smaller quantities may not whip to maximum volume.

#### To assemble:

The egg whip consists of 4 pieces – the egg whip stem, stem cover, whip paddle, and cap.

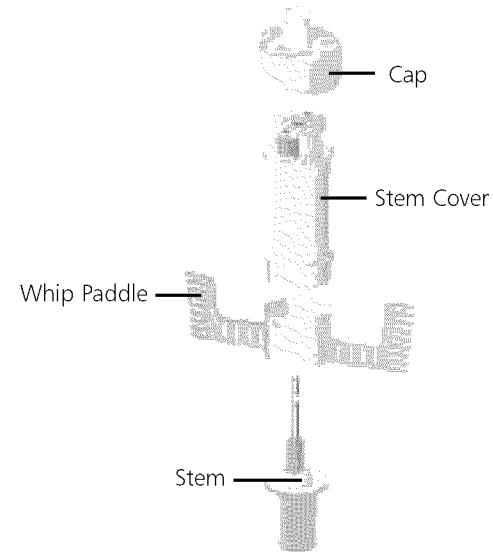

Continued...

# PREPARING THE FOOD PROCESSOR FOR USE

1. Place the egg-whip stem on the power shaft. Slowly turn the stem until it drops fully onto the shaft.
2. Align the L-shaped notch on the whip paddle with the small post on the stem cover, and slide the paddle onto the cover. Turn slightly to lock paddle.
3. Fit the stem cover and paddle over the egg whip stem. Push downward to engage the ridges of the stem with the gears of the paddle.
4. Fit the egg whip cap over the egg whip stem. Push downward to lock it into place.
5. Place the work bowl cover on the work bowl with the feed tube just to the left of the handle. Make sure the center pin of the egg whip fits into the center opening of the cover. Grasp the feed tube and turn the cover to the right to lock it into place. Insert the pusher into the feed tube. The egg whip is now ready to operate.
6. Press the On Button and whip ingredients to the desired texture and volume. Press the Off Button when finished.

## **To disassemble:**

1. Unplug the base from the electrical outlet. Remove the work bowl cover with a clockwise turn.
2. Lift the egg whip assembly off the power shaft. Remove whipped ingredients from the work bowl.
3. Pull the cap from the egg whip assembly. Push downward on the stem pin to remove stem from the stem cover. Turn the egg whip paddle to unlock, and slide the paddle from the stem cover.

# USING THE PRO LINE™ SERIES FOOD PROCESSOR

<b>⚠ WARNING</b>

<b>Rotating Blade Hazard</b>
<b>Always use food pusher.</b>
<b>Keep fingers out of openings.</b>
<b>Keep away from children.</b>
<b>Failure to do so can result in amputation or cuts.</b>

## Before Use

Before operating the food processor, be sure the work bowl, blades, and work bowl cover are properly assembled on the food processor base (see “Preparing the Food Processor for Use” starting on page 12).

## Food Pusher Interlock

The food pusher is part of the safety interlock system. The food processor will not run unless the pusher is inserted to the maximum fill line on the feed tube.

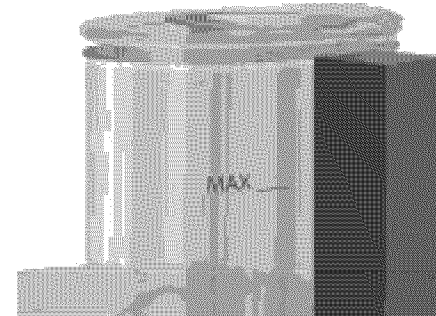

## Maximum Liquid Level

This line on the work bowl indicates the maximum level of liquid that can be processed by the food processor.

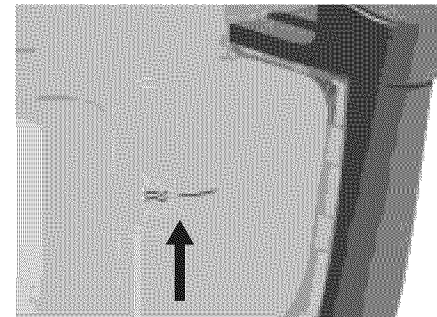

# USING THE PRO LINE™ SERIES FOOD PROCESSOR

## Turning the Food Processor On and Off

1. To turn on the food processor, press the On Button. The unit will run continuously and the blue indicator light will glow.

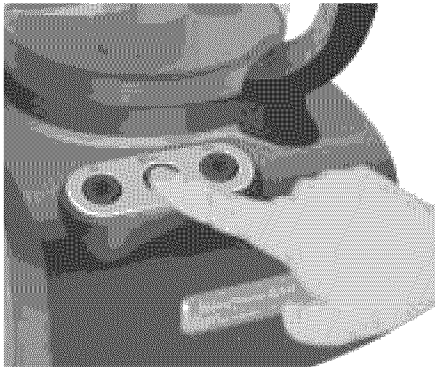

2. To stop the food processor, press the Off Button. The blue indicator light will go out and an automatic brake will stop the action of the blade or disk within seconds.
3. Wait until the blade or disk comes to a complete stop before removing the work bowl cover. Be sure to turn off the food processor before removing the work bowl cover, or before unplugging the unit.

**NOTE:** If the unit fails to operate, make sure the work bowl and cover are properly locked on the base, and the food pusher is inserted to the maximum fill line on the feed tube (see "Preparing the Food Processor for Use" starting on page 12).

## Using the Pulse Control

The pulse control allows precise control of the duration and frequency of processing. It's great for jobs which require a light touch. Just press and hold the Pulse Button to start processing, and release it to stop. The blue indicator light will glow each time the Pulse Button is pressed.

## 2-Piece Food Pusher

To slice or shred small items, insert the 2-piece food pusher into the feed tube, then turn the small center pusher clockwise to unlock and remove. Use the center feed tube and pusher to process small or slender items, or to add liquid while the food processor is running. When not using the small feed tube, lock the small pusher into place by turning it counter-clockwise.

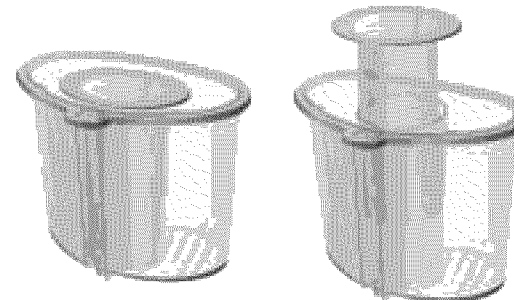

# DISASSEMBLING THE FOOD PROCESSOR

## **! WARNING**

### **Cut Hazard**

**Handle blades carefully.**

**Failure to do so can result in cuts.**

**NOTE:** If you have difficulty removing the pusher from the feed tube, it is likely that food particles have become lodged in the interlock system. To free the pusher, soak the work bowl cover in warm water or wash it in a dishwasher.

1. Turn the work bowl cover to the left and remove.

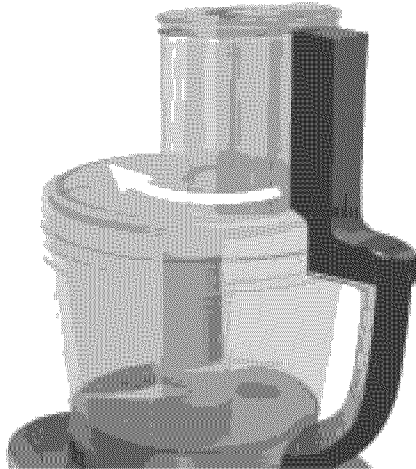

2. If using a disc, remove it before removing the bowl. Place two fingers under each side of the disc and lift it straight up. Remove the disc stem.

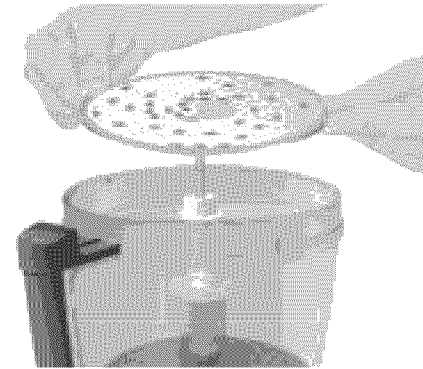

3. If using the mini bowl or chef's bowl, grasp and remove the bowl using the finger grips located along the top edge of the bowl.

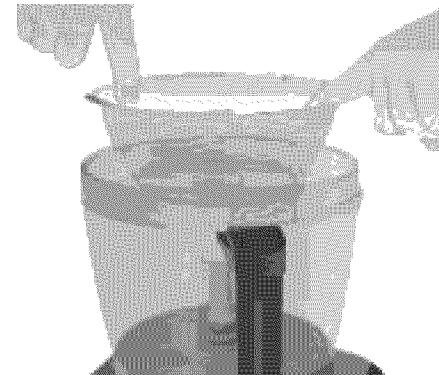

Continued...

# DISASSEMBLING THE FOOD PROCESSOR

4. Turn the work bowl to the left to unlock it from the base. Lift to remove.



5. The multipurpose blade can be removed from the work bowl before the contents are emptied. The blade can also be held in place as you remove food: grasp the work bowl from the bottom and place one finger through the center opening to grip the blade shaft. Then remove food from the bowl and blade with a spatula.

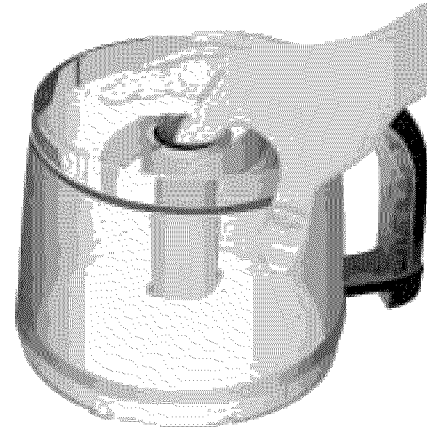

# CARE AND CLEANING

## **⚠ WARNING**

### **Cut Hazard**

**Handle blades carefully.**

**Failure to do so can result in cuts.**

**1** Press the Off Button and unplug the food processor before cleaning.

**2** Wipe the metal base with a warm, sudsy cloth and wipe clean with a damp cloth. Dry with a soft cloth. Do not use abrasive cleansers or scouring pads.

**NOTE:** Do not use sharp objects to clean around the control buttons; damage may result. Use a soft brush.

**3** All the other parts of the PRO LINE™ Series Food Processor are dishwasher safe. Be sure to load them away from exposed heating elements in the dishwasher. If washing the Food Processor parts by hand, avoid the use of abrasive cleansers or scouring pads—they may scratch or cloud the work bowl and cover. A long-handled dish brush will facilitate hand-cleaning. Thoroughly dry all parts after washing.

**4** Wipe cord with a warm, sudsy cloth; wipe cord clean with a damp cloth. Dry with a soft cloth.

**5** To prevent damage to the interlock system, always store the work bowl and work bowl cover in the unlocked position when not in use.

**6** Disassembled discs, shafts, and blades should be stored in the provided storage case, and in a location out of the reach of children.

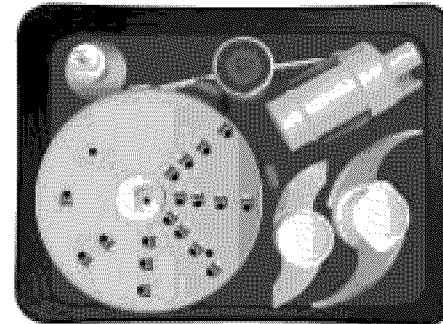
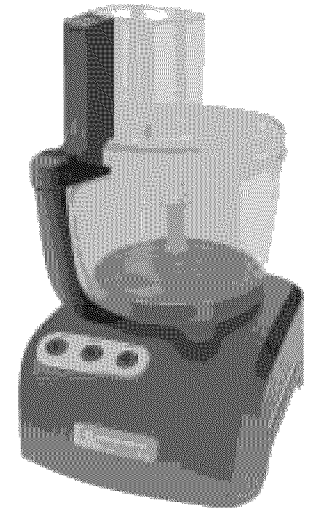

# TROUBLESHOOTING

- **If your food processor should fail to operate, check the following:**

- Make sure the work bowl and work bowl cover are properly locked on the base, and the food pusher is inserted to the maximum fill line on the feed tube.
- See if the food processor is plugged into a grounded 3 prong outlet. If it is, unplug the food processor, then plug it into the same outlet again. If the food processor still does not work, check the fuse or circuit breaker on the electrical circuit the food processor is connected to and make sure the circuit is closed.

- **If the food processor shuts off while it is running:**

- The food processor may be overheated. If the motor exceeds a certain temperature, it will automatically shut off to prevent damage. This should be an extremely rare occurrence. If it happens, press the Off Button and wait 15 minutes for the food processor to cool before resuming. If the food processor still refuses to run, wait an additional 15 minutes for the food processor to cool.

- **If you have difficulty removing the food pusher from the feed tube:**

- Food particles are probably lodged in the interlock system. To free the pusher, soak the work bowl cover in warm water or wash it in a dishwasher.

If the problem cannot be corrected with the steps in this section, see the KitchenAid Warranty and Service section on page 93\*.

\* Do not return the food processor to the retailer – they do not provide service.

**KitchenAid®**  
PRO LINE™ SERIES

# FOOD PROCESSING

## TIPS AND RECIPES

### Tips and Recipes Section Contents

Using the Multipurpose Blade.....	24
Using a Slicing or Shredding Disc.....	26
Using the Dough Blade.....	27
Using the Egg Whip.....	28
Helpful Hints.....	29
Recipes.....	33

# FOOD PROCESSING TIPS

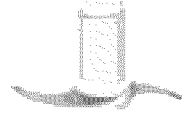

## Using the Multipurpose Blade

### To chop fresh fruits or vegetables:

Peel, core, and/or remove seeds. Cut food in 1 to 1½-inch pieces. Process food to desired size, using short pulses, 1 to 2 seconds each time. Scrape sides of bowl if necessary.

### To puree cooked fruits and vegetables (except potatoes):

Add ¼ cup liquid from recipe per cup of food. Process food, using short pulses, until finely chopped. Then process continuously until desired texture is achieved. Scrape sides of bowl if necessary.

### To prepare mashed potatoes:

Insert chef's bowl into the work bowl. Using the shredding disc, shred hot, cooked potatoes. Remove the chef's bowl with potatoes. Place multipurpose blade in work bowl, and add shredded potatoes, softened butter, milk, and seasonings. Pulse 3 to 4 times, 2 to 3 seconds each time, until milk is absorbed and texture is smooth. Do not overprocess.

### To chop dried (or sticky) fruits:

The fruit should be cold. Add ¼ cup of flour from recipe per ½ cup dried fruit. Applying short pulses, process fruit until desired texture is achieved.

### To finely chop citrus peel:

With a sharp knife, peel colored portion (without white membrane) from citrus. Cut peel into small strips. Process until finely chopped.



**To mince garlic, or to chop fresh herbs or small quantities of vegetables:**

With processor running, add food through the small feed tube. Process until chopped. For best results, make sure work bowl and ingredients are very dry before chopping garlic or fresh herbs.

**To chop nuts or make nut butters:**

Process up to 3 cups of nuts to desired texture, using short pulses, 1 to 2 seconds each time. For a coarser texture, process smaller batches, pulsing 1 or 2 times, 1 to 2 seconds each time. Pulse more often for finer texture. For nut butters, process continuously until smooth. Store in refrigerator.

**To chop cooked or raw meat, poultry, or seafood:**

The food should be very cold. Cut in 1-inch pieces. Process up to 2½ pounds at a time to desired size, using short pulses, 1 to 2 seconds each time. Scrape sides of bowl if necessary.

**To make bread, cookie, or cracker crumbs:**

Break food into 1½ to 2-inch pieces. Process until fine. For larger pieces, pulse 2 to 3 times, 1 to 2 seconds each time. Then process until fine.

**To melt chocolate:**

Combine chocolate and sugar from recipe in work bowl. Process until finely chopped. Heat liquid from recipe. With processor running, pour hot liquid through the small feed tube. Process until smooth.

**To grate hard cheeses, such as Parmesan and Romano:**

Never attempt to process cheese that cannot be pierced with the tip of a sharp knife. You can use the multipurpose blade to grate hard cheeses. Cut cheese in 1-inch pieces. Place in work bowl. Process, using short pulses, until coarsely chopped. Process continuously until finely grated.

# FOOD PROCESSING TIPS



## Using a Slicing or a Shredding Disc

**NOTE:** When cutting and packing food items in the Ultra Wide Mouth™ feed tube, do not exceed the maximum fill line; this will permit the pusher to engage the interlock and the unit to operate.

### To cut julienne or match-stick strips of vegetables and fruits:

Cut food to fit feed tube horizontally. Position food horizontally in feed tube. Process, applying even pressure to make plank-like slices. Re-stack slices and position vertically or horizontally in feed tube. Process, applying even pressure.

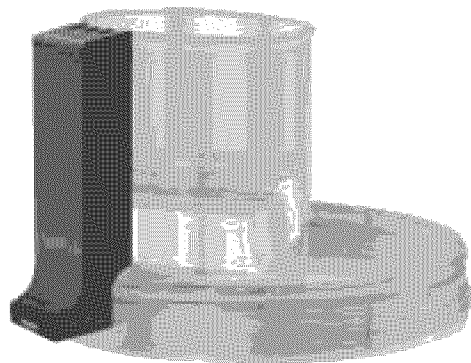

### To slice or shred fruits or vegetables that are long and relatively small in diameter, such as celery, carrots, and bananas:

Cut food to fit feed tube vertically or horizontally, and pack feed tube securely to keep food properly positioned. Process, applying even pressure. Or use the small feed tube in the two-piece food pusher. Position food vertically in the tube, and use the small food pusher to process the food.

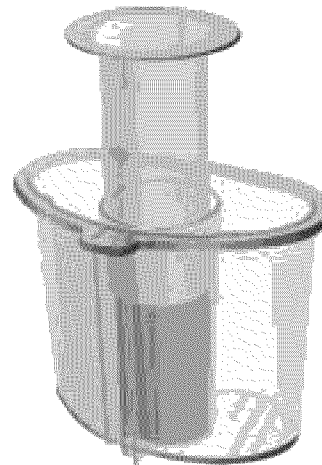

### To slice or shred fruits and vegetables that are round, such as onions, apples, and green peppers:

Peel, core, and/or remove seeds. Cut into halves or quarters to fit feed tube. Position in feed tube and process, applying even pressure.

**To slice or shred fruits and vegetables that are small, such as strawberries, mushrooms, and radishes:**

Position food vertically or horizontally in layers within the feed tube. Fill feed tube in order to keep food positioned properly, but do not exceed the maximum fill line. Process, applying even pressure. Or use the small feed tube in the two-piece food pusher. Position food vertically in the tube and use the small food pusher to process food.

**To shred spinach and other leaves:**

Stack leaves. Roll up stacked leaves and stand the rolls vertically in the feed tube. Process, applying even pressure.

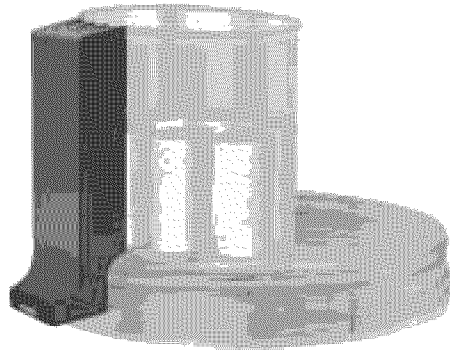

**To slice uncooked meat or poultry, such as stir-fry meats:**

Cut or roll food to fit feed tube. Wrap and freeze meat until it is solid to touch (30 minutes to 2 hours depending on thickness of meat). Make sure you can still pierce the meat with the tip of a sharp knife. If not, allow meat to thaw slightly. Process, applying even pressure.

**To slice cooked meat or poultry, including salami, pepperoni, etc.:**

Cooked meat should be very cold. Cut into pieces to fit feed tube. Process food, using firm, even pressure.

**To shred firm and soft cheeses:**

Firm cheese should be very cold. For best results with soft cheeses, such as mozzarella, freeze 10 to 15 minutes before processing. Cut to fit feed tube. Process, applying even pressure.



**Using the Dough Blade**

The dough blade is specially designed for mixing and kneading yeast dough quickly and thoroughly. For the best results, do not knead recipes that use more than 6 cups of all-purpose flour, or 4 cups of whole grain flour.

Continued...

# FOOD PROCESSING TIPS

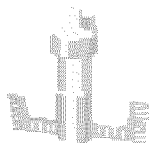

## Using the Egg Whip

### To make egg white meringue:

Place 4 egg whites and  $\frac{1}{4}$  teaspoon cream of tartar in work bowl fitted with the egg whip attachment. Process about 15 to 20 seconds, until foamy. With processor running, slowly add  $\frac{1}{4}$  to  $\frac{1}{2}$  cup of sugar through the small feed tube. Process until stiff peaks form, about 4 minutes. Stop processor as necessary to check texture of mixture.

### To whip cream:

Pour 1 cup heavy cream in work bowl fitted with egg whip attachment. Process 30 seconds. With processor running, add 2 tablespoons powdered sugar through the small feed tube. Process until soft peaks form, about 30 to 40 seconds. Stop processor as necessary to check texture of mixture. With processor running, add  $\frac{1}{2}$  teaspoon of vanilla, if desired, through the small feed tube. Process until mixed. Do not overprocess.

For the best results, never attempt to whip more than 2 cups of cream.

# HELPFUL HINTS

**1**

When cutting and packing food items in the Ultra Wide Mouth™ feed tube, do not exceed the maximum fill line. This will permit the pusher to engage the interlock and the unit to operate.

**2**

Organize processing tasks to minimize bowl cleanup. Process dry or firm ingredients before liquid ingredients.

**3**

After removing the work bowl cover, place it upside down on the counter. This will help keep the counter clean.

**4**

To easily clean ingredients from the multipurpose blade, just empty the work bowl, replace the lid, and pulse 1 to 2 seconds to spin the blade clean.

**5**

Do not overfill work bowl or mini bowl. For thin mixtures, fill work bowl up to  $\frac{1}{2}$  to  $\frac{2}{3}$  full. For thicker mixtures, fill work bowl up to  $\frac{3}{4}$  full. For liquids, fill to the maximum level as indicated on the work bowl (see “Maximum Liquid Level” on page 17). When chopping, the work bowl should be no more than  $\frac{1}{3}$  to  $\frac{1}{2}$  full. Use the mini bowl for up to 1 cup of liquid or  $\frac{1}{2}$  cup solids.

## HELPFUL HINTS

**6**

To capitalize on the speed of the processor, drop ingredients to be chopped through the small feed tube while the processor is running.

**7**

Position slicing discs so the cutting surface is just to the right of the feed tube. This allows the blade a full rotation before contacting food.

**8**

Different foods require varying degrees of pressure for best shredding and slicing results. In general, apply light pressure for soft, delicate foods (strawberries, tomatoes, etc.), moderate pressure for medium foods (zucchini, potatoes, etc.), and firmer pressure for harder foods (carrots, apples, hard cheeses, partially frozen meats, etc.).

**9**

Never process any food that is so hard or firmly frozen that it cannot be pierced with the tip of a sharp knife. Hard food can cause damage to the blade or motor. If a piece of hard food, such as carrot, becomes wedged or stuck on the blade, stop the processor and remove the blade. Using special care, remove food from the blade.

**10**

When preparing a cake or cookie batter or quick bread, use the multipurpose blade to cream fat and sugar first. Add dry ingredients last. Place nuts and fruit on top of flour mixture to prevent overchopping. Process nuts and fruits with short pulses until blended with other ingredients. Do not overprocess.

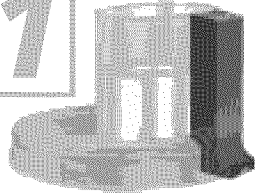
**11**

Sometimes slender foods, such as carrots or celery, fall over in the feed tube, resulting in an uneven slice. To minimize this, cut food in several pieces and pack the feed tube with the food. For processing small or slender items, the small feed tube in the two piece food pusher will prove especially convenient.

**12**

Soft and medium-hard cheese may spread out or roll up on the shredding disc. To avoid this, shred only chilled cheese.

**13**

When shredded or sliced food piles up on one side of the bowl, stop the processor and redistribute food using a spatula.

**14**

When food quantity reaches the bottom of a slicing or shredding disc, stop processing and remove the food.

**15**

A few larger pieces of food may remain on top of the disc after slicing or shredding. If desired, cut these by hand and add them to the mixture.

## HELPFUL HINTS

16

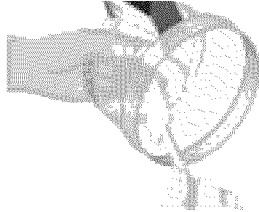

To remove the contents of the work bowl without removing the multipurpose blade, grasp the work bowl from the bottom and place one finger through the center opening to hold the blade in place. Then remove food from the bowl and blade with a spatula.

17

Your Food Processor isn't designed to perform the following functions:

- Grind coffee beans, grains, or hard spices.
- Grind bones or other inedible parts of food.
- Liquefy raw fruits or vegetables.
- Slice hard-cooked eggs or meats that have not been chilled.

18

If any plastic parts should discolor due to the types of food processed, simply clean with a light bleach solution, following directions on the bleach container.

**KitchenAid®**  
PRO LINE™ SERIES

# FOOD PROCESSOR RECIPES

## Food Processor Recipe Section Contents

Appetizer Serving Suggestions.....	34
Appetizers.....	35
Salad and Dressings.....	44
Soups and Sandwiches.....	52
Vegetables and Side Dishes.....	63
Main Dishes.....	68
Breads.....	75
Desserts.....	82

# APPETIZER **PREPARATION** AND **SERVING** SUGGESTIONS

- When planning your menu, select an assortment of both hot and cold appetizers.
- It's always wise to select as many make-ahead recipes as possible.
- At minimum, plan on preparing 4 appetizers per guest per hour.
- Set out serving dishes and platters needed for each menu item well in advance of your event.
- Bake your appetizers in batches, so fresh, warm hors d'oeuvres will always be available.
- For recipes calling for cooked chicken, consider:
  - purchasing broasted chicken from the deli
  - steaming, poaching, or grilling chicken breasts or thighs
  - using prepared or packaged chicken strips or cubes
- To keep your hors d'oeuvres at the proper serving temperature, consider using slow cookers, heated chafing dishes, ice baths, and so forth.
- When you're serving exotic or unfamiliar appetizers, label them with decorative place cards on the buffet table. Consider including a short story or explanation of the history, ingredients, or special preparation that went into their creation.

# CRAB-STUFFED MUSHROOMS

Position mini bowl and mini blade in work bowl. Add croissants. Process until finely crumbled, 5 to 10 seconds.

Exchange mini bowl and mini blade for multipurpose blade in work bowl. With processor running, add shallots and garlic through small feed tube. Process until finely chopped, about 5 seconds. Remove stems from mushrooms; add 1 cup stems to work bowl. Pulse 3 to 4 times, about 1 second each time.

In medium skillet over medium heat, melt butter. Add vegetable mixture; cook 4 to 5 minutes, or until tender, stirring often. Return vegetable mixture to work bowl. Add bread crumbs, crabmeat, tarragon, salt, and lemon juice. Process until mixed, 3 to 5 seconds.

Arrange mushrooms cap side down in 15x10x1-inch baking pan. Spoon and press crab mixture into openings, mounding stuffing. Press cheese on top of stuffing. Bake at 350° F for 20 to 25 minutes, or until mushrooms are tender. Sprinkle with chives, if desired.

Yield: 10 servings (3 mushrooms per serving).

Tip: Filling may be made up to one day in advance; refrigerate. Warm to room temperature before stuffing mushrooms.

Per Serving: About 130 cal, 8 g pro, 10 g carb, 7 g total fat, 4 g sat fat, 30 mg chol, 220 mg sod.

- 2 large bakery croissants or white bread slices, torn into pieces
- 2 shallots, cut into quarters
- 2 cloves garlic
- 30 large (about two 14 oz. packages) mushrooms, cleaned
- 1 tablespoon butter
- 1 can (6 oz.) crabmeat, well-drained
- ½ teaspoon dried tarragon
- ¼ teaspoon salt
- 1 tablespoon lemon juice
- 1 cup freshly grated Asiago or Parmesan cheese
- 2 tablespoons snipped fresh chives, if desired

# SESAME-ALMOND CRACKERS

- 1½ cups rolled oats
- 1 cup (about 4 oz.) sliced almonds
- 2 cups all-purpose flour
- 1 cup whole wheat flour
- 2 tablespoons sugar
- 1½ teaspoons salt
- 1 teaspoon baking soda
- ¼ cup shortening
- ¼ cup butter or margarine, slightly softened
- 1¼ cups buttermilk
- 1 egg, beaten
- 1 tablespoon water
- 2 teaspoons coarse salt, divided
- ¼ cup black sesame seeds\*, divided
- ¼ cup white sesame seeds\*, divided

\* Other cracker toppings might include garlic powder, onion powder, sliced almonds, poppy seeds, or sunflower seeds.

Position multipurpose blade in work bowl. Add oats and almonds. Pulse 3 to 4 times, about 5 seconds each time, or until finely ground. Add all-purpose and whole wheat flours, sugar, salt, and baking soda. Process until mixed, 5 to 10 seconds. Add shortening and butter. Pulse 4 to 5 times, about 2 seconds each time, or until crumbly. With processor running, add buttermilk through small feed tube. Process until stiff dough forms, about 30 seconds, scraping sides of bowl if necessary.

In small bowl, combine egg and water. Set aside.

Remove dough to lightly floured work surface. Form into a ball; divide into 4 portions. Keep dough covered until ready to roll. Roll 1 portion into a 10x10-inch square. Place in center of large lightly greased cookie sheet. Roll evenly into a 12x12-inch square. Brush with egg mixture. Sprinkle with ½ teaspoon coarse salt, 1 tablespoon black sesame seeds, and 1 tablespoon white sesame seeds. Roll lightly with rolling pin. With pastry wheel, pizza cutter, or sharp knife, score to form 36 squares, or other desired shape. Do not separate. Repeat with remaining dough, egg mixture, salt, and sesame seeds.

Bake at 350° F for 15 to 25 minutes, or until golden brown. If outside crackers start to brown first, remove them to a cooling rack and continue baking until center crackers are golden brown. Remove crackers to cooling rack.

Yield: 12 dozen (about 6 crackers per serving).

Per Serving: About 160 cal, 5 g pro, 19 g carb, 8 g total fat, 2.5 g sat fat, 15 mg chol, 370 mg sod.

# CARAMELIZED ONION PUFF PASTRY SQUARES

Position 4 mm shredding disc and chef's bowl in work bowl. Add Gouda cheese. Process to shred. Set aside.

Position 4 mm slicing disc in work bowl. Add onions to feed tube, cutting to fit tube, if necessary. Process to slice.

In large skillet or Dutch oven over medium-high heat, heat oil, until it sizzles. Add onions; cook 5 to 10 minutes, or until onions are limp, stirring occasionally. Stir in brown sugar and 2 tablespoons vinegar. Cook over medium-low heat 35 to 45 minutes, or until soft and light golden, stirring occasionally. Stir in remaining 1 tablespoon vinegar, pepper, and salt. Set aside.

On lightly floured surface, roll each sheet of puff pastry into a 12-inch square. Place on 2 large ungreased baking sheets.

Bake at 400° F for 9 to 11 minutes, or until pastry puffs and edges begin to brown, gently pricking top of pastry with fork after 5 minutes. Reduce oven temperature to 375° F. Lightly prick tops of pastry with fork. Sprinkle Parmesan cheese evenly over pastry to within ½ inch of edges. Top evenly with onions. Sprinkle Gouda cheese over onions. Bake at 375° F for 10 to 15 minutes, or until pastry is golden brown and cheese is melted and bubbly. Cool slightly. Cut each pastry into 36 squares.

Yield: 24 servings (3 squares per serving).

Per Serving: About 180 cal, 5 g pro, 13 g carb, 12 g total fat, 4 g sat fat, 15 mg chol, 200 mg sod.

- 1 package (7 oz.) Gouda or smoked Gouda cheese, wax removed
- 4 medium yellow onions
- 1 tablespoon vegetable oil
- 3 tablespoons brown sugar
- 3 tablespoons balsamic vinegar, divided
- ½ teaspoon cracked black pepper
- ⅛ teaspoon salt
- 1 package (17¼ oz.) frozen puff pastry, thawed
- 1 cup freshly grated Parmesan cheese

# HOT ARTICHOKE DIP

- 6 ounces Asiago cheese, room temperature
- 1 red or green jalapeno pepper, seeded and cut into quarters
- 1 clove garlic
- 2 cans (14 oz. each) artichoke hearts\*, well drained
- 1 cup mayonnaise
- ½ cup chive and onion sour cream
- 1 package (3 oz.) cream cheese

\* For chunkier dip, reserve 2 to 3 pieces of artichoke hearts; cut into ½-inch chunks, and stir into dip when adding to baking pan.

Position chef's bowl and 4 mm shredding disc in work bowl. Add Asiago cheese. Process to shred; set aside.

Exchange chef's bowl and shredding disc for multipurpose blade in work bowl. With processor running, add jalapeno pepper and garlic through small feed tube. Process until finely chopped. Add artichoke hearts. Pulse 3 to 4 times, about 2 seconds each time, or until chopped. Add mayonnaise, sour cream, cream cheese, and Asiago cheese. Process until blended, about 5 seconds.

Remove to greased 9-inch quiche pan or pie plate. Bake at 375°F about 20 minutes, or until hot. Serve with crackers, French bread, tiny corn muffins, or crisp vegetables.

Yield: 32 servings (2 tablespoons per serving).

Per Serving: About 90 cal, 2 g pro, 2 g carb, 9 g total fat, 2.5 g sat fat, 15 mg chol, 170 mg sod.

# CAMEMBERT SALMON DIP

Position multipurpose blade in work bowl. Add onions. Process until coarsely chopped, 3 to 4 seconds. Add cream cheese, Camembert cheese, and vinegar, if desired. Process until creamy, 5 to 10 seconds. Add salmon. Process until mixed, 8 to 10 seconds, scraping bowl if necessary. Add peppers and capers. Pulse 5 times, about 1 second each time, until coarsely chopped.

Remove to greased 9-inch pie plate or quiche pan. Bake at 350°F for 10 to 15 minutes, or until heated thoroughly. Garnish with parsley, if desired. Serve with crostini, pita chips, crackers, or vegetable dippers.

Yield: 20 servings (2 tablespoons per serving).

Per Serving: About 80 cal, 7 g pro, 2 g carb, 5 g total fat, 2.5 g sat fat, 20 mg chol, 320 mg sod.

- 4 *green onions, cut into 1-inch pieces*
- 1 *package (8 oz.) light cream cheese, room temperature and cut into 1-inch pieces*
- 4 *ounces soft Camembert cheese, rind removed, if desired, and cut into 1-inch pieces*
- 1 *tablespoon white balsamic vinegar, if desired*
- 2 *cans (7 oz. each) red salmon\**
- 1 *jar (7 oz.) roasted red peppers, well drained and cut into 1-inch pieces*
- 1 *jar (3 oz.) capers, drained*  
*Chopped parsley leaves, if desired*

*\* If desired, reserve 1/3 cup salmon chunks to flake and fold into dip before spreading into baking pan.*

# CHIPOTLÉ DEVEILED EGGS

- $\frac{3}{4}$  cup loosely packed fresh cilantro leaves
- $\frac{1}{2}$  medium onion, cut into 1-inch pieces
- 5–6 chipotle chilies in adobo sauce, drained (from a 7 or 11-oz. can)
- 26 hard-cooked eggs, peeled and cut into halves lengthwise
- 1 cup mayonnaise or salad dressing
- $\frac{1}{4}$  cup sour cream
- $\frac{3}{4}$  teaspoon salt

Position mini bowl and mini blade in work bowl. With processor running, add cilantro through small feed tube. Process until finely chopped, 5 to 8 seconds. Set aside.

Exchange mini bowl and mini blade for multipurpose blade in work bowl. Add onion and chilies to work bowl. Process until finely chopped, 10 to 15 seconds. Add 4 egg halves (whites and yolks) and remaining 48 egg yolk halves. Set remaining 48 egg white halves aside. Process yolk mixture until finely chopped, about 5 seconds. Add mayonnaise, sour cream, salt, and cilantro. Pulse 3 to 5 times, about 2 seconds each time, or until mixed; scrape sides of bowl if necessary.

Pipe or spoon generous amounts of mixture into reserved egg white halves.

Yield: 24 servings (2 egg halves per serving).

Tip: Purchase fresh eggs close to their "sell-by" date for easy peeling after cooking.

Per Serving: About 160 cal, 7 g pro, 1 g carb, 14 g total fat, 3 g sat fat, 235 mg chol, 230 mg sod.

# TROPICAL FRUIT SALSA

Position multipurpose blade in work bowl. With processor running, add cilantro through small feed tube. Process until chopped, 3 to 5 seconds. With processor running, add peppers. Process until chopped, 3 to 5 seconds. Add jicama. Pulse 2 to 3 times, about 2 seconds each time, or until chopped. Add remaining ingredients. Pulse 3 to 4 times, about 2 seconds each time, or until chopped and mixed. Chill at least 1 hour to blend flavors. Serve crackers or pita triangles with cream cheese topped with Tropical Fruit Salsa. Or serve with grilled skewered shrimp.

Yield: 22 servings (¼ cup per serving).

Tip: May be made 1 to 2 days in advance and refrigerated.

Per Serving: About 20 cal, 0 g pro, 6 g carb, 0 g total fat, 0 g sat fat, 0 mg chol, 10 mg sod.

- ½ cup loosely packed fresh cilantro or parsley leaves*
- 1–2 jalapeno peppers, cut into halves and seeded*
- ½ cup jicama chunks*
- 3 cups (about 1 lb.) fresh pineapple chunks*
- 2 seedless oranges, peeled and cut into eighths*
- 1 medium mango, peeled, seeded and cut into chunks*
- 1 tablespoon fresh lime juice*
- ½ teaspoon salt*

# SHRIMP DILL DIP

- 2 *tablespoons fresh dill or 1½ teaspoons dried dill*
- 3 *green onions, cut into 1-inch pieces*
- 1 *strip lemon peel, yellow portion only*
- 2 *packages (8 oz. each) cream cheese, softened*
- 8 *ounces sour cream*
- ½ *cup mayonnaise or salad dressing*
- 2 *tablespoons fresh lemon juice*
- 2–3 *teaspoons horseradish*
- ½–¾ *teaspoon hot pepper sauce*
- ½ *teaspoon salt*
- 2 *packages (7 oz. each) frozen cooked tiny shrimp, thawed and drained*

Position mini bowl and mini blade in work bowl. With processor running, add dill through small feed tube. Process until chopped. Add onions. Process until finely chopped, 5 to 10 seconds. Set aside.

Exchange mini bowl and mini blade for multipurpose blade in work bowl. With processor running, add lemon peel through small feed tube. Process until finely chopped, 5 to 10 seconds. Add cream cheese, sour cream, mayonnaise, lemon juice, horseradish, pepper sauce, and salt. Process until smooth, 10 to 15 seconds. Add dill mixture. Pulse 1 to 2 times, about 2 seconds each time, or until mixed; scrape bowl if necessary. Add shrimp. Pulse 3 times, about 1 second each time, or until mixed.

Before serving, chill at least 1 hour to blend flavors.

Yield: 40 servings (2 tablespoons per serving).

Per Serving: About 80 cal, 3 g pro, 1 g carb, 7 g total fat, 3.5 g sat fat, 35 mg chol, 200 mg sod.

# ROASTED SALSA VERDE

Place yellow and serrano peppers, garlic, tomatillos, bell pepper, and onion in 15x10x2-inch baking pan. Drizzle with oil; toss to coat. On top rack, bake at 450° F about 20 minutes, or until tomatillos are blistered and garlic is tender, stirring once or twice. Cool slightly.

Position multipurpose blade in work bowl. With processor running, add lime peel through small feed tube. Process until chopped, 10 to 15 seconds. Add lime juice, sugar, salt, and vegetable mixture with any accumulated juices. Pulse 2 to 3 times, about 1 second each time, or until chopped. Serve chilled or at room temperature with skewered grilled chicken or shrimp, or tortilla chips.

Yield: 24 servings (2 tablespoons per serving).

Tip: May be made 1 to 2 days in advance, if desired.

Per Serving: About 20 cal, 0 g pro, 3 g carb, 1 g total fat, 0 g sat fat, 0 mg chol, 75 mg sod.

- 3 *mild yellow chile peppers, cut into halves and seeded*
- 2 *serrano chile peppers, cut into halves and seeded*
- 4 *large cloves garlic, peeled*
- 1½ *pounds fresh tomatillos, husks removed*
- 1 *red bell pepper, seeded and cut into 2-inch pieces*
- 1 *small onion, cut into quarters*
- 1 *tablespoon olive or vegetable oil*
- 4 *strips lime peel, green portion only*
- 2 *tablespoons fresh lime juice*
- 2 *teaspoons sugar*
- ¾ *teaspoon salt*

# WHITE BALSAMIC VINAIGRETTE

- 1 *tablespoon fresh basil leaves*
- 1 *tablespoon fresh oregano leaves*
- 1 *clove garlic*
- 3 *tablespoons white balsamic vinegar\**
- 3 *tablespoons white wine vinegar\**
- $\frac{1}{2}$  *teaspoon salt*
- $\frac{1}{4}$  *teaspoon dry mustard*
- $\frac{1}{8}$  *teaspoon ground red pepper*
- $\frac{3}{4}$  *cup extra virgin olive oil*

*\* Three tablespoons each of dark balsamic vinegar and red wine vinegar may be substituted.*

Position multipurpose blade in work bowl. With processor running, add basil, oregano, and garlic through small feed tube. Process until chopped, 5 to 8 seconds. Scrape sides of bowl. With processor running, add balsamic vinegar, wine vinegar, salt, mustard, and red pepper. Process until mixed, about 5 seconds. With processor running, slowly drizzle oil through feed tube. Process until smooth and thick. Serve with green salads.

Yield: 8 servings (2 tablespoons per serving).

Per Serving: About 190 cal, 0 g pro, 1 g carb, 21 g total fat, 3 g sat fat, 0 mg chol, 150 mg sod.

# MEDITERRANEAN HOT CHICKEN SALAD

Position multipurpose blade in work bowl. Add onions, olives, and chicken. Pulse 4 to 6 times, 1 to 2 seconds each time, or until coarsely chopped. Remove to large mixing bowl.

Exchange multipurpose blade for 4 mm slicing disc. Add fennel. Process to slice. Add to mixing bowl.

Exchange slicing disc for mini bowl and mini blade in work bowl. Add all remaining ingredients except cheese and nuts. Process until mixed, 10 to 12 seconds. Add to mixing bowl. Add cheese to mixing bowl; stir to combine.

Spread into greased 13x9x2-inch baking pan. Sprinkle with pine nuts. Bake at 375° F for 25 to 30 minutes, or until thoroughly heated. Serve with pitas, flatbread, or lettuce wraps.

Yield: 10 servings (about  $\frac{3}{4}$  cup per serving).

Per serving: About 440 cal, 30 g pro, 5 g carb, 33 g total fat, 7 g sat fat, 95 mg chol, 510 mg sod.

- 6 *green onions, cut into 1-inch pieces*
- $\frac{1}{2}$  *cup whole pitted kalamata olives*
- 6 *cups (about 1 $\frac{3}{4}$  pounds) cooked chicken chunks*
- 1 *bulb fennel, cut into quarters lengthwise*
- 1 *cup mayonnaise*
- $\frac{1}{2}$  *cup sour cream*
- 1 *tablespoon all-purpose flour*
- 2 *tablespoons fresh oregano leaves*
- 2 *tablespoons lemon juice*
- $\frac{1}{4}$ – $\frac{1}{2}$  *teaspoon salt*
- $\frac{1}{4}$  *teaspoon black pepper*
- 1 *cup (4 oz.) crumbled feta cheese*
- $\frac{1}{2}$  *cup pine nuts*

# CITRUS DRESSING

- 2 *strips lime peel, green portion only*
- 1 *strip orange peel, orange portion only*
- 2 *green onions, cut into 1-inch pieces*
- 1 *cup vegetable oil*
- $\frac{1}{3}$  *cup white wine vinegar*
- 3 *tablespoons fresh lime juice*
- 1 *seedless orange, peeled and sectioned*
- 1 *teaspoon poppy seeds, if desired*
- $\frac{1}{2}$  *teaspoon dry mustard*
- 1 *tablespoon sugar*
- $\frac{1}{4}$  *teaspoon black pepper*

Position multipurpose blade in work bowl. With processor running, add lime and orange peels through small feed tube. Process until chopped, about 20 seconds. Add remaining ingredients. Process until smooth, 10 to 15 seconds. Serve over mixed greens or fruit, or use to marinate chicken, pork, or fish.

Yield: 16 servings (2 tablespoons per serving).

Per Serving: About 130 cal, 0 g pro, 2 g carb, 14 g total fat, 2.5 g sat fat, 0 mg chol, 0 mg sod.

# FRESH JICAMA SALAD

Position multipurpose blade in work bowl. With processor running, add lime peel through small feed tube. Process until minced, 10 to 12 seconds; scrape sides of bowl. Add remaining dressing ingredients. Process until blended, 5 to 8 seconds; scrape sides of bowl.

Exchange multipurpose blade for 4 mm slicing disc in work bowl. Add jicama, oranges, onion, and celery to feed tube in batches. Process to slice. Remove to large mixing bowl. Toss gently to mix and coat. Cover; refrigerate at least 2 hours to blend flavors. Serve on lettuce-lined plate, if desired.

Yield: 8 servings (¾ cup per serving).

Per Serving: About 120 cal, 1 g pro, 14 g carb, 7 g total fat, 1.5 g sat fat, 0 mg chol, 170 mg sod.

## DRESSING

- 2 strips lime peel
- ¼ cup vegetable oil
- 2 tablespoons lime juice
- 1 teaspoon Dijon mustard
- ½ teaspoon sugar
- ½ teaspoon salt
- ⅛–¼ teaspoon crushed red pepper

## SALAD

- 1 medium (about 1 lb.) jicama, peeled and cut into eighths lengthwise
- 2 seedless oranges, peeled and cut into halves lengthwise
- ½ red onion, cut into halves lengthwise
- 2 ribs celery, cut into 2½-inch pieces
- Lettuce leaves, if desired

# CHICKEN WILD RICE SALAD

## SALAD

- 8–10 *medium green onions, cut into 1-inch pieces*
- 6 *boneless, skinless chicken breast halves (about 2 lb.), grilled or broiled and cooled*
- 1 *large red bell pepper, seeded and cut into quarters lengthwise*
- 2 *medium ribs celery*
- 5 *cups cooked wild rice, cooled*

## DRESSING

- $\frac{3}{4}$  *cup vegetable oil*
- $\frac{1}{3}$  *cup white wine or rice wine vinegar*
- 2 *tablespoons Dijon mustard*
- $\frac{3}{4}$  *teaspoon salt*
- $\frac{3}{4}$  *teaspoon cracked black pepper*
- $\frac{1}{2}$ – $\frac{3}{4}$  *teaspoon hot pepper sauce*

Position multipurpose blade in work bowl. Add onions. Pulse 1 to 2 times, about 2 seconds each time, or until chopped.

Exchange multipurpose blade for 4 mm slicing disc in work bowl. Add chicken, bell pepper, and celery in batches. Process to slice. Remove to large mixing bowl. Add rice; toss to mix.

Exchange slicing disc for multipurpose blade in work bowl. Add dressing ingredients. Process until smooth, 3 to 5 seconds. Pour dressing over salad mixture. Toss to coat.

Yield: 12 servings.

Tip: Entire salad may be assembled 1 day in advance and refrigerated.

Per serving: About 270 cal, 17 g pro, 16 g carb, 16 g total fat, 3 g sat fat, 35 mg chol, 260 mg sod.

# ASIAN COLESLAW FOR A CROWD

Position 4 mm slicing disc in work bowl. Add cabbage and onion in batches, cutting to fit feed tube if necessary. Process to slice. Remove to very large mixing bowl.

Remove and reserve seasoning packets from noodles. Crumble noodles into cabbage mixture. Add nuts; toss to mix.

Exchange slicing disc for multipurpose blade in work bowl. Add oil, vinegar, sugar, and contents of noodle seasoning packets. Process until blended and sugar is dissolved, 10 to 15 seconds. Pour dressing over salad. Toss to coat.

Chill at least 1 hour before serving to blend flavors.

Yield: 32 servings (½ cup per serving).

Tip: Recipe may be halved, if desired.

Per serving: About 80 cal, 1 g pro, 7 g carb, 5 g total fat, 1 g sat fat, 0 mg chol, 80 mg sod.

## SALAD

- 1 large head (about 2 lb.) Napa cabbage, cored
- 1 medium red onion, cut into quarters lengthwise
- 2 packages (3 oz. each) ramen noodles (shrimp, chicken, or vegetable flavor)
- ½ cup salted sunflower nuts

## DRESSING

- ½ cup vegetable oil
- ¼ cup white wine vinegar
- ¼ cup sugar

# HOT POTATO SALAD

- 12 *medium (about 2 lb.) red potatoes boiled, peeled and cooled*
- 1 *medium onion, cut into halves lengthwise*
- $\frac{1}{4}$  *medium red bell pepper, cut into quarters lengthwise*
- 6 *slices thick bacon*
- 2 *tablespoons all-purpose flour*
- 2 *tablespoons sugar*
- $\frac{3}{4}$  *teaspoon celery seed*
- $\frac{1}{2}$  *teaspoon salt*
- $\frac{1}{2}$  *teaspoon cracked black pepper*
- $1\frac{1}{4}$  *cups water*
- $\frac{1}{3}$  *cup cider vinegar*
- Chopped fresh parsley, if desired*

Position chef's bowl and 4 mm slicing disc in work bowl. Add potatoes. Process to slice. Set aside.

Exchange chef's bowl and slicing disc for 2 mm slicing disc in work bowl. Add onion and bell pepper. Process to slice. Set aside.

In 12-inch skillet over medium heat, cook bacon until crisp. Remove bacon, reserving 3 tablespoons drippings. Drain bacon on paper towels, crumble, and set aside. Place reserved drippings in skillet. Add onion mixture. Cook and stir over medium-low heat 3 to 4 minutes, or until tender. Add flour, sugar, celery seed, salt, and black pepper; mix well.

Add water and vinegar. Heat to boiling, stirring constantly. Boil for 1 minute; add reserved potatoes and bacon. Stir gently to blend. Heat until warm. Garnish with chopped fresh parsley, if desired.

Yield: 10 servings ( $\frac{3}{4}$  cup per serving).

Per serving: About 160 cal, 3 g pro, 23 g carb, 6 g total fat, 2.5 g sat fat, 10 mg chol, 280 mg sod.

# BROCCOLI-KOHLRABI CONFETTI SALAD

Position multipurpose blade in work bowl. Add cauliflower. Pulse 5 to 6 times, about 1 second each time, or until chopped. Remove to large mixing bowl.

Cut broccoli florets into 1½-inch pieces and reserve stalk. Add florets to work bowl. Pulse 3 to 5 times, about 1 second each time, or until chopped. Add to mixing bowl.

Exchange multipurpose blade for 4 mm shredding disc in work bowl. Add kohlrabi, carrots, and reserved broccoli stalk, cutting to fit feed tube if necessary. Process to shred. Add to mixing bowl.

Exchange shredding disc for multipurpose blade in work bowl. Add dressing ingredients. Process until smooth, 10 to 15 seconds. Pour dressing over vegetables. Toss to coat.

Chill at least 1 hour to blend flavors.

Yield: 20 servings (½ cup per serving).

Per serving: About 70 cal, 1 g pro, 4 g carb, 6 g total fat, 1 g sat fat, 0 mg chol, 85 mg sod.

## SALAD

- 1 package (1 lb.) fresh cauliflower florets, cut into 1½-inch pieces
- 1 stalk (about ¾ lb.) broccoli
- 2 bulbs kohlrabi, peeled
- 3 medium carrots, peeled

## DRESSING

- ½ cup vegetable oil
- ¼ cup red wine vinegar
- 2 tablespoons fresh lemon juice
- 3 green onions, cut into 1-inch pieces
- 1½ teaspoons prepared mustard
- 1 teaspoon sugar
- ½ teaspoon salt
- ½–¾ teaspoon cracked black pepper

# CHEDDAR BROCCOLI SOUP

- 2 *tablespoons fresh parsley leaves*
- 8 *ounces sharp Cheddar cheese, chilled*
- 1 *small onion, cut into halves*
- 1 *rib celery, cut into 2½-inch pieces*
- 2 *tablespoons butter or margarine*
- 1 *large stalk (about 1 lb.) broccoli*
- 3½ *cups chicken broth*
- 2 *cups milk, divided*
- ¼ *cup all-purpose flour*
- 2 *teaspoons Dijon mustard*
- 1 *teaspoon curry powder, if desired*
- ⅛ *teaspoon hot pepper sauce*

Position mini bowl and mini blade in work bowl. With processor running, add parsley through small feed tube. Process until coarsely chopped, 5 to 10 seconds. Set aside.

Exchange mini bowl and mini blade for chef's bowl and 4 mm shredding disc. Add cheese. Process to shred. Set aside.

Exchange chef's bowl and shredding disc for 2 mm slicing disc in work bowl. Add onion and celery. Process to slice. Melt butter in large saucepan or Dutch oven over medium heat. Remove onion and celery to saucepan. Cook 5 to 6 minutes, or until crisp-tender, stirring occasionally.

Cut stems from broccoli, and peel tough coating from stems. Cut florets into small pieces. Position 2 mm slicing disc in work bowl. Add broccoli stems. Process to slice. Remove to saucepan.

Add broccoli florets and broth to saucepan. Bring to a boil over medium-high heat. Reduce heat; partially cover and simmer 8 to 10 minutes, or until broccoli is crisp-tender, stirring occasionally. Remove from heat.

Exchange slicing disc for multipurpose blade in work bowl. With slotted spoon, remove vegetables from saucepan to work bowl. Add 1 cup milk. Process until chopped, 5 to 8 seconds.

In medium mixing bowl, whisk flour into remaining 1 cup milk, whisking until smooth. Add mustard, curry powder, if desired, and pepper sauce. Stir until combined.

Add milk mixture to broth in saucepan. Cook over medium-high heat until bubbly and slightly thickened, stirring often. Reduce heat to low. Add cheese; stir until melted.

Add broccoli mixture to saucepan. Heat thoroughly. Garnish each serving with parsley.

Yield: 8 servings (1 cup per serving).

Per Serving: About 220 cal, 12 g pro, 13 g carb, 14 g total fat, 8 g sat fat, 45 mg chol, 710 mg sod.

# CHICKEN CHUTNEY SANDWICH SPREAD

Position chef's bowl and 4 mm slicing disc in work bowl. Add chicken and jicama to feed tube. Process to slice. Exchange chef's bowl and slicing disc for multipurpose blade in work bowl. Remove chicken and jicama to work bowl. Add walnuts, mayonnaise, chutney, salt, and pepper. Pulse 3 to 4 times, about 2 seconds each time, or until finely chopped and thoroughly mixed. Spread on bread for sandwiches, or wrap in lettuce leaves for wraps.

Yield: 7 servings (½ cup per serving).

Tip: Chicken may be made 1 day ahead and refrigerated.

Per Serving: About 300 cal, 9 g pro, 21 g carb, 21 g total fat, 2.5 g sat fat, 25 mg chol, 590 mg sod.

4 *grilled or broiled boneless, skinless chicken breast halves\**, cooled

1 *cup cubed jicama*

⅓ *cup walnuts*

½ *cup mayonnaise or salad dressing*

1 *jar (9 oz.) mango chutney (about ⅓ cup)*

¼–½ *teaspoon salt*

¼ *teaspoon black pepper*

\* *Eight boneless, skinless chicken thighs may be substituted for breasts.*

# ROASTED BUTTERNUT SQUASH SOUP

## WITH HERB PISTOU

### SOUP

- 1 *large (about 2½ lb.) butternut squash, peeled, seeded, and cut into quarters lengthwise*
- 1 *large onion, cut into halves lengthwise*
- 2 *large cloves garlic, cut into quarters*
- 2 *tablespoons olive oil*
- 5 *cups chicken broth, divided*
- 1 *can (15 oz.) pumpkin puree*
- $\frac{3}{4}$  *teaspoon salt*
- 1 *cup whipping cream*

### SAUCE

- 2 *cups loosely packed fresh parsley leaves*
- $\frac{1}{4}$  *cup loosely packed fresh sage leaves*
- 2 *tablespoons fresh thyme leaves*
- 2 *cloves garlic*
- 1 *teaspoon lemon juice*
- $\frac{1}{4}$  *teaspoon salt*
- $\frac{1}{3}$  *cup olive oil*

### SOUP

Position 4 mm slicing disc in work bowl. Add squash and onion in batches. Process to slice. Remove to 15x10x1-inch pan. Add garlic and drizzle with oil; toss to coat. Bake at 450° F for 30 to 35 minutes, or until tender, stirring once or twice. (Pan will be very full at first but decreases as vegetables cook.) Cool slightly.

Exchange slicing disc for multipurpose blade in work bowl. Add roasted vegetable mixture and juices, 1½ cups broth, pumpkin, and salt. Process until well mixed, about 1 minute. With processor running, add an additional 1½ cups broth through small feed tube. Process until smooth, 45 to 60 seconds. Remove to large saucepan or Dutch oven. Stir in remaining 2 cups broth.

Cook over medium heat until thoroughly heated. Stir in cream; heat just until hot. Top each serving with about 2 teaspoons Herb Pistou.

### PISTOU SAUCE

Position mini bowl and mini blade in work bowl. With processor running, add parsley, sage, thyme, garlic, lemon juice, and salt through the small feed tube. Process until finely chopped, about 5 seconds; scrape sides of bowl if necessary. With processor running, gradually add oil. Process until well mixed.

Yield: 10 (1 cup servings).

Per Serving: About 220 cal, 3 g pro, 19 g carb, 16 g total fat, 6 g sat fat, 30 mg chol, 700 mg sod.

# RUNZA POCKET SANDWICHES

Combine milk, water, and butter in small saucepan. Heat until warm, 105°F to 115°F. Stir in yeast to dissolve. Set aside.

Position dough blade in work bowl. Add 4½ cups flour, sugar, and salt. Process until mixed, 5 to 8 seconds. With processor running, slowly add yeast mixture through small feed tube. Add eggs. Process 1 minute, adding up to an additional ½ cup flour, if necessary, for dough to pull from side of bowl. Dough will be sticky. Remove dough to greased bowl, turning to grease all sides. Cover. Let dough rest about 30 minutes.

Meanwhile, exchange dough blade for chef's bowl and 4 mm slicing disc. Add cabbage to feed tube in batches. Process to slice. Set aside.

Exchange chef's bowl and slicing disc for multipurpose blade in work bowl. Add onion. Pulse 2 to 3 times, about 2 seconds each time, or until chopped. Remove to medium skillet; add beef, salt, and pepper. Cook over medium-high heat until beef is thoroughly cooked, onion is tender, and most liquid has evaporated, stirring often. Set aside.

In Dutch oven or large skillet over medium-high heat, melt butter. Add cabbage; cook until cabbage wilts, 7 to 10 minutes. Add beef mixture; toss to mix. Set aside.

Divide dough in half. On floured surface, roll half of dough into a 20x15-inch rectangle (about ⅛-inch thick). With pizza cutter or knife, cut into 12 squares. Place ¼ cup meat mixture in center of each square. Bring corners of dough together to center of Runza. Pinch edges and corners together to seal. Place seam side up on lightly greased baking sheet. Cover; let rise in warm place 30 minutes. Bake at 350°F for 18 to 20 minutes, or until golden brown. Serve with favorite mustard, if desired.

Yield: 12 servings (2 sandwiches per serving).

Tip: To freeze, place unbaked Runzas in a sealed bag and freeze for up to 1 month. Bake at 350°F for 25–35 minutes, or until golden brown.

Per Serving: About 460 cal, 19 g pro, 47 g carb, 22 g total fat, 12 g sat fat, 105 mg chol, 640 mg sod.

## DOUGH

- ¾ cup milk
- ½ cup water
- ½ cup butter or margarine, cut into chunks
- 2 packages active dry yeast
- 4½–5 cups all-purpose flour, divided
- ½ cup sugar
- 1 teaspoon salt
- 2 eggs

## FILLING

- 1½ pounds (about ½ medium head) cabbage, cut into 3-inch chunks
- 1 medium onion, cut into 1-inch pieces
- 1½ pounds lean ground beef
- 2 teaspoons salt
- ½ teaspoon black pepper
- 6 tablespoons butter or margarine

# PAN-FRIED VEGGIE BURGERS

- 8 ounces Monterey Jack cheese, chilled
- 2 large cloves garlic
- ¼ small red onion, cut into 1-inch pieces
- 1 cup fresh mushrooms
- ¼ medium green bell pepper, cut into 1-inch pieces
- 1 medium rib celery, cut into 1-inch pieces
- 1 can (16 oz.) pinto or kidney beans, well drained
- 1 can (8¾ oz.) whole kernel corn, drained
- 2 cups cooked brown rice (not instant)
- ⅓ cup dry bread crumbs
- 1 teaspoon ground cumin
- ¾ teaspoon dried oregano
- ¾ teaspoon black pepper
- ¼ teaspoon cayenne pepper
- ¼ teaspoon salt
- 1–2 tablespoons olive oil
- 1–2 tablespoons butter or margarine

Position chef's bowl and 4 mm slicing disc in work bowl. Add cheese. Process to slice. Set aside.

Exchange slicing disc for multipurpose blade in work bowl. With processor running, add garlic through small feed tube. Process until finely chopped, 5 to 8 seconds. Add onion, mushrooms, bell pepper and celery. Pulse 4 to 5 times, about 2 seconds each time, or until chopped.

Add beans, corn, rice, bread crumbs, cumin, oregano, black pepper, cayenne pepper, and salt. Pulse 3 to 4 times, about 1 second each time, or until just mixed. Shape into 8 patties (about ½ cup each).

In large nonstick skillet over medium heat, heat olive oil and butter. Add patties in batches, if necessary. Cook about 4 minutes, or until golden brown. Carefully turn. Top each patty with cheese. Reduce to medium-low heat. Cook 5 to 6 minutes, or until patties are golden brown and cheese is melted.

If desired, serve with whole wheat sandwich buns or pita pockets, tomato slices, leaf lettuce, mayonnaise, and mustard.

Yield: 8 servings.

Per serving: About 290 cal, 12 g pro, 31 g carb, 13 g total fat, 6 g sat fat, 35 mg chol, 350 mg sod.

# WINTER VEGETABLE SOUP

In large Dutch oven or stockpot over high heat, add broth, water, pork hocks, onion, 1 celery rib, garlic, bay leaves, ½ teaspoon thyme, and pepper. Bring to a boil. Reduce heat, cover, and simmer 1 ½ hours.

Meanwhile, position multipurpose blade in work bowl. Add leeks. Pulse 5 to 6 times, about 1 second each time, or until chopped. Exchange multipurpose blade for 4 mm slicing disc. Add parsnips, carrots, and remaining 1 rib celery in batches, cutting to fit feed tube if necessary. Process to slice. In large saucepan or Dutch oven over medium heat, heat oil. Add vegetable mixture. Cook and stir 8 to 10 minutes, or until crisp-tender. Set aside.

Position chef's bowl and 4 mm slicing disc in work bowl. Add squash, rutabaga, and turnips in batches, cutting to fit feed tube. Process to slice. Set aside.

Exchange slicing disc for 4 mm shredding disc in work bowl. Add potatoes. Process to shred. Set aside.

Remove pork hocks from broth. Remove meat, cut into small pieces, and set aside. Strain broth; skim fat from broth, if desired.

Continued...

- 6 cups chicken broth
- 1½ cups water
- 2–2½ pounds smoked pork hocks
- 1 medium onion, cut into quarters
- 2 large ribs celery, cut into 2½-inch pieces, divided
- 3 cloves garlic, peeled and quartered
- 2 bay leaves
- 1½ teaspoons thyme, divided
- ½ teaspoon black pepper
- 2 medium leeks, white part only, cut into 1-inch pieces
- 4 parsnips, peeled
- 3 large carrots, peeled
- ¼ cup olive oil
- 1 small (about 1 lb.) butternut squash, peeled, seeded, and cut into quarters lengthwise
- 1 medium (about 1 lb.) rutabaga, peeled and cut into 2-inch pieces

Continued...

# WINTER VEGETABLE SOUP

- 2 *turnips, peeled and cut into quarters lengthwise*
- 2 *medium russet potatoes, peeled*
- $\frac{1}{2}$  *cup fresh parsley leaves, if desired*

Add cooked and raw vegetables to broth with remaining 1 teaspoon thyme. Heat to boiling. Reduce heat, cover, and simmer 30 to 45 minutes, or until vegetables are tender.

Exchange shredding disc for mini bowl and mini blade in work bowl. With processor running, add parsley through small feed tube. Process until finely chopped, about 10 seconds.

Add parsley and reserved meat pieces to soup. Heat 10 minutes and serve.

Yield: 16 servings (1 cup per serving).

Tips: For vegetarian soup, omit pork and substitute vegetable broth for chicken broth. Soup also freezes well.

Per Serving: About 170 cal, 7 g pro, 20 g carb, 7 g total fat, 1.5 g sat fat, 15 mg chol, 400 mg sod.

# MUFFALETTA SANDWICHES

Position chef's bowl and 4 mm slicing disc in work bowl. Add tomatoes to feed tube; process to slice. Set aside.

Exchange chef's bowl and slicing disc for multipurpose blade in work bowl. With processor running, add basil and parsley through the small feed tube. Process to chop, about 5 seconds. With processor running, add garlic. Process until chopped, 5 to 10 seconds. Add onion to work bowl. Pulse 2 to 3 times, about 1 second each time, or until chopped. Scrape sides if necessary. Add green, ripe, and kalamata olives, roasted red peppers, vinegar, oregano, black pepper, and olive oil to work bowl. Process until blended, about 10 seconds.\*

Spread about 2 tablespoons olive mixture on each side of bread. Top with meats and cheese. To warm, if desired, wrap each sandwich loosely in foil. Bake at 375° F for 15 to 20 minutes, or until hot and cheese is melted.

Yield: 12 servings.

Tip: Olive mixture may be made 1 to 2 days in advance and refrigerated. Also, serve as dip with crackers or toasted pita triangles.

Per Serving: About 850 cal, 36 g pro, 74 g carb, 45 g total fat, 14 g sat fat, 70 mg chol, 2520 mg sod.

\* Twelve hoagie buns may be substituted for bread.

- 2 medium plum tomatoes
- 4 large fresh basil leaves, if desired
- 3 tablespoons fresh parsley leaves
- 4 large cloves garlic
- 1/8 small red onion, peeled and cut into 1-inch pieces
- 1/2 cup pimiento-stuffed green olives
- 1 cup pitted ripe olives
- 1 cup pitted kalamata olives
- 1/2 cup prepared roasted red peppers, drained
- 2 tablespoons white wine vinegar
- 1/2 teaspoon dried oregano
- 1/2 teaspoon coarse black pepper
- 1/2 cup extra virgin olive oil
- 3 loaves French bread, cut into 6-inch lengths and split lengthwise
- 1 pound thinly sliced salami
- 1 pound thinly sliced smoked ham or prosciutto
- 12 slices provolone cheese

# FRENCH ONION SOUP

- 1 *pound Gruyere or Swiss cheese, room temperature*
- 4 *jumbo yellow onions, cut into halves lengthwise*
- 6 *tablespoons butter or margarine*
- 2 *tablespoons all-purpose flour*
- $\frac{3}{4}$  *teaspoon black pepper*
- 6 *cups beef broth*
- 2 *cups chicken broth*
- $\frac{3}{4}$  *cup dry sherry*
- $1\frac{1}{2}$  *teaspoons Worcestershire sauce*
- 14 *slices French bread ( $\frac{1}{2}$ -in. thick diagonal slices), lightly toasted*
- 5 *ounces freshly grated Parmesan cheese*

Position chef's bowl and 4 mm shredding disc in work bowl. Add Gruyere cheese. Process to shred. Set aside.

Exchange chef's bowl shredding disc for 4 mm slicing disc in work bowl. Add onions in batches. Process to slice.

In Dutch oven over medium-high heat, melt butter. Add onions. Cook and stir 10 to 15 minutes, or until onions are tender. Add flour and pepper; mix well. Add beef and chicken broths, sherry, and Worcestershire sauce. Heat to boiling. Reduce heat; simmer 10 to 15 minutes, or until flavors are blended.

Spoon 1 cup soup into each of 14 individual oven-proof bowls. Top with bread and Gruyere cheese. Sprinkle with Parmesan cheese. Place under broiler, 4 to 6 inches from heat, for 2 to 3 minutes, or until cheese is melted and bubbly.

Yield: 14 servings (1 cup per serving).

Per Serving: About 360 cal, 19 g pro, 23 g carb, 20 g total fat, 12 g sat fat, 60 mg chol, 950 mg sod.

# CREOLE GUMBO

Position mini bowl and mini blade in work bowl. With processor running, add parsley through small feed tube. Process until chopped, 10 to 15 seconds. Set aside.

Exchange mini bowl and mini blade for multipurpose blade in work bowl. With processor running, add garlic through small feed tube. Process until chopped, 5 to 10 seconds. Add bell peppers, celery, and onions. Pulse 4 to 5 times, about 2 seconds each time, or until chopped. Scrape sides of bowl. Set aside.

In large heavy saucepan or skillet over medium-low heat, combine oil and flour. Cook until dark brown (about the color of chocolate syrup), 20 to 25 minutes, stirring constantly. Reduce heat to low as mixture darkens. Remove from heat immediately. Add chopped vegetables. Cook over low heat until crisp-tender, about 15 minutes, stirring frequently.

Meanwhile, in Dutch oven over medium-high heat, melt butter. Add chicken. Cook until browned, 4 to 5 minutes, stirring occasionally.

Continued...

- 1/4 cup loosely packed parsley leaves*
- 4 cloves garlic, peeled*
- 2 medium green bell peppers, seeded and cut into 2-inch pieces*
- 2 medium ribs celery, cut into 1-inch pieces*
- 2 medium onions, cut into 1-inch pieces*
- 1/2 cup vegetable oil*
- 2/3 cup all-purpose flour*
- 2 tablespoons butter or margarine*
- 2 pounds chicken breast tenders, cut into halves crosswise*
- 1/2 pound smoked ham or Polish sausage, cut into 1-inch pieces*
- 1 can (28 oz.) diced tomatoes, undrained*
- 1 package (16 oz.) frozen sliced okra*
- 3 cups chicken broth*

Continued...

# CREOLE GUMBO

- 1 *tablespoon Worcestershire sauce*
- 2 *teaspoons salt*
- 1½ *teaspoons sugar*
- 1½ *teaspoons fresh thyme leaves or ½ teaspoon dried thyme*
- 2 *bay leaves*
- ½ *teaspoon crushed red pepper flakes*
- ½ *teaspoon hot pepper sauce*
- 2 *pounds uncooked medium shrimp, shelled and deveined*

Meanwhile, position multipurpose blade in work bowl. Add ham. Pulse 3 or 4 times, about 2 seconds each time, or until coarsely chopped. Remove to Dutch oven. Add cooked vegetable mixture, parsley, and remaining ingredients except shrimp. Heat until bubbly. Reduce heat; cover and simmer 30 to 40 minutes, or until flavors blend and chicken and vegetables are tender. Add shrimp. Cook 5 to 8 minutes, or until shrimp turn pink and opaque.

Remove and discard bay leaves. Serve in bowls over hot cooked rice.

Yield: 16 servings (1 cup per serving).

Per Serving: About 250 cal, 26 g pro, 11 g carb, 11 g total fat, 3 g sat fat, 125 mg chol, 810 mg sod.

# SWEET DILLED CUCUMBERS AND ONIONS

Position multipurpose blade in work bowl. Add ½ cup vinegar, dill, sugar, salt, and pepper. Process until dill is finely chopped and sugar is dissolved, about 10 seconds. Add remaining ½ cup vinegar. Pulse about 1 second, or until mixed.

Exchange multipurpose blade for 4 mm slicing disc in work bowl. Add cucumbers and onion, cutting to fit if necessary. Process to slice.

Remove to large bowl or large resealable food storage plastic bag; mix well. Refrigerate 8 hours or overnight, stirring or turning occasionally.

Drain cucumbers and onions well. Stir in sour cream.

Yield: 16 servings (½ cup per serving).

Per Serving: About 50 cal, 1 g pro, 7 g carb, 3 g total fat, 2 g sat fat, 5 mg chol, 160 mg sod.

- 1 cup white wine vinegar, divided
- ½ cup firmly packed fresh dill
- ⅓ cup sugar
- 1 teaspoon salt
- ¼ teaspoon black pepper
- 3 medium seedless cucumbers, cut into 2½-inch lengths
- 1 medium onion, cut into halves lengthwise
- 1 cup sour cream

# LAYERED EGGPLANT AND PEPPER CASSEROLE

- 1 *medium eggplant (about 1½ lb.)*
- 3 *tablespoons olive oil*
- 4 *ounces mozzarella cheese*
- 2 *ounces Parmesan cheese*
- 1 *cup ricotta cheese*
- 1 *egg*
- ¼ teaspoon salt, if desired*
- ¼ teaspoon pepper*
- 2 *cups prepared tomato basil pasta sauce, divided*
- 1 *jar (7 oz.) roasted red peppers, well drained*

Position chef's bowl and 4mm slicing disc in work bowl. Cut eggplant into 2½-inch lengths to fit feed tube. Process to slice. Remove to 15x10x1-inch pan, and arrange evenly. (Slices will overlap.) Drizzle with olive oil. Bake at 450° F for 8 minutes, or until slightly tender.

Meanwhile, exchange slicing disk for shredding disc. Add mozzarella to feed tube. Process to shred. Set aside.

Position 4 mm shredding disc in work bowl. Add Parmesan cheese to feed tube. Process to shred. Exchange shredding disc for multipurpose blade. Add ricotta cheese, egg, salt, and black pepper to work bowl. Process about 10 seconds, or until mixed.

Pour 1 cup pasta sauce into greased 12x8x2-inch baking pan. Layer half of eggplant on top of sauce. Top with half of red peppers and half of ricotta cheese mixture. Repeat layers of eggplant, red peppers, and ricotta cheese. Top with remaining pasta sauce and mozzarella cheese. Bake at 350° F. for 30 minutes or until eggplant is tender and casserole is bubbly.

Yield: 8 servings.

Per Serving: About 250 cal, 12 g pro, 19 g carb, 14 g total fat, 6 g sat fat, 50 mg chol, 610 mg sod.

# SPRING MIX BASMATI RICE

Position multipurpose blade in work bowl. With processor running, add garlic to small feed tube. Process 5 seconds. Add shallot. Pulse 2 to 3 times, about 2 seconds each time, or until chopped. In Dutch oven or large saucepan over medium-low heat, heat oil and melt butter. Add shallot mixture. Cook until tender, 1 to 2 minutes, stirring often. Remove from heat; set aside.

Exchange multipurpose blade for 4 mm slicing disk in work bowl. Add green beans and carrot to feed tube. Process to slice. Remove to Dutch oven with shallot mixture. Add broth, water, salt, black pepper, and coriander, if desired. Bring to a boil. Stir in rice. Return to boil; reduce heat. Cover, simmer 15 to 20 minutes, or until liquid is absorbed.

Meanwhile, cut tips from asparagus and reserve stalks; set aside. Position multipurpose blade in work bowl. With processor running, add thyme and parsley to small feed tube. Process until chopped, about 3 seconds. Add bell pepper. Pulse 2 to 3 times, 1 to 2 seconds each time, or until coarsely chopped. Exchange multipurpose blade for 4 mm slicing disk in work bowl. Add asparagus stalks to feed tube. Process to slice. Remove to Dutch oven with rice mixture. Add asparagus tips; stir well.

Cover; let stand 10 minutes. Fluff with a fork.

Yield: 12 servings (1 cup per serving).

Per Serving: About 200 cal, 4 g pro, 44 g carb, 2.5 g total fat, 1 g sat fat, 5 mg chol, 530 mg sod.

- 2 cloves garlic
- 1 medium shallot, cut into quarters
- 1 tablespoon olive oil
- 1 tablespoon butter or margarine
- ½ pound (about 2 cups) fresh green beans, trimmed
- 1 medium carrot, peeled and cut into 2 pieces
- 3 cups chicken broth
- 2 cups water
- 1½ teaspoons salt
- ¼ teaspoon black pepper
- 2 teaspoons ground coriander, if desired
- 2⅔ cups basmati or jasmine rice
- ½ pound fresh asparagus
- 1 tablespoon fresh thyme leaves
- ¼ cup loosely packed fresh parsley leaves
- ¼ small red bell pepper, cut into quarters

# BOURBONED CARROTS

- 1½ pounds carrots, peeled*
- ½ pound parsnips\*, peeled*
- ½ small onion*
- ¼ cup packed brown sugar*
- ½ cup bourbon*
- 3 tablespoons water*
- 3 tablespoons butter  
or margarine*
- ¼ teaspoon salt*
- ⅛ teaspoon black pepper*

*\* If desired, substitute an additional ½ pounds carrots for parsnips.*

Position 4 mm slicing disc in work bowl. Add carrots, parsnips, and onion in batches, cutting to fit feed tube if necessary. Process to slice.

In large skillet or Dutch oven over medium-high heat, combine brown sugar, bourbon, and water. Bring to a boil. Add carrot mixture; stir to coat. Bring to a boil. Cover; cook over medium heat 5 minutes. Uncover; simmer 5 to 10 minutes, or until liquid evaporates and carrots are coated and tender. Add butter, salt, and pepper. Stir to coat.

Yield: 8 servings (½ cup per serving).

Per Serving: About 130 cal, 1 g pro, 18 g carb, 4.5 g total fat, 2.5 g sat fat, 10 mg chol, 125 mg sod.

# LOADED BAKED POTATO CASSEROLE

In 12-inch skillet over medium heat, cook bacon until crisp. Remove bacon, reserving 3 tablespoons drippings; drain bacon on paper towels, crumble, and set aside.

Position chef's bowl and 4 mm shredding disc in work bowl. Add Cheddar cheeses and Parmesan cheese in batches, cutting to fit feed tube if necessary. Process to shred. Set aside.

In Dutch oven over high heat, add water and 1½ teaspoons salt; bring to boil. Meanwhile, position 4 mm shredding disc in work bowl. Add potatoes in batches, cutting to fit feed tube if necessary. Process to shred. If desired, rinse potatoes and drain well. When water boils, add potatoes; return to a boil. Cook 1 minute, or until crisp-tender. Drain well.

Exchange shredding disc for mini work bowl and mini blade in work bowl. With processor running, add parsley and onions through small feed tube. Process until chopped, 2 to 3 seconds. Set aside.

In large mixing bowl, combine sour cream, flour, remaining ¾ teaspoon salt, pepper, milk, and reserved bacon drippings; mix well. Add potatoes, shredded cheeses, onion mixture, and reserved bacon; toss gently to mix well. Spread into greased 13x9x2-inch baking pan.

Split French bread lengthwise. Butter cut sides; place cut sides together. Cut into 1-inch pieces. Exchange mini bowl and mini blade for multipurpose blade in work bowl. Add buttered bread to work bowl. Process until fine crumbs form, 5 to 8 seconds. Sprinkle crumb mixture over potatoes. Bake at 350° F for 60 to 75 minutes, or until golden brown and edges are bubbly.

Yield: 16 servings (¾ cup per serving).

Per Serving: About 330 cal, 12 g pro, 23 g carb, 22 g total fat, 12 g sat fat, 60 mg chol, 430 mg sod.

- 6 strips bacon
- 8 ounces extra sharp Cheddar cheese, chilled
- 6 ounces smoked sharp Cheddar cheese, chilled
- 2 ounces Parmesan cheese, room temperature
- 2½ quarts water
- 2¼ teaspoons salt, divided
- 3 pounds russet potatoes
- ⅓ cup loosely packed fresh parsley leaves
- 8 green onions, cut into 1-inch pieces
- 3 cups sour cream
- 3 tablespoons all-purpose flour
- ¾ teaspoon cracked black pepper
- ⅔ cup milk
- 1 slice (3 in.) French bread
- 1 tablespoon butter or margarine, softened

# SZECHWAN PORK

- 4 *large cloves garlic*
- $\frac{1}{4}$  *cup peeled ginger root chunks*
- $\frac{1}{4}$  *cup soy sauce*
- 2 *tablespoons sherry*
- 2 *teaspoons dark sesame oil, divided*
- $1\frac{1}{2}$  *pounds pork tenderloin, cut into 3-inch pieces and frozen for 1 to 1½ hours*
- $2\frac{1}{2}$ –3 *teaspoons crushed red pepper flakes*
- 1 *red or yellow bell pepper, cut into halves lengthwise, and seeded*
- 3 *ribs celery, cut into 2½-inch pieces*
- 6 *green onions, cut diagonally into ½-inch slices*
- 1 *cup chicken broth*
- 1 *tablespoon cornstarch*
- Hot cooked rice or Chinese noodles, if desired*

Position multipurpose blade in work bowl. With processor running, add garlic and ginger root through small feed tube. Process until chopped, 5 to 8 seconds. Scrape sides of bowl. Add soy sauce, sherry, 1 teaspoon sesame oil, and red pepper flakes. Process until mixed, about 5 seconds. Scrape sides of bowl, if necessary.

Exchange multipurpose blade for 4 mm slicing disc in work bowl. Add pork. Process to slice. Remove to shallow dish or large resealable food storage plastic bag; coat pork with marinade. Refrigerate for 1 hour.

Meanwhile, wash processor. Position 4 mm slicing disc in work bowl. Add bell peppers and celery. Process to slice.

In large skillet over medium-high heat, add half of pork mixture. Cook 4 to 5 minutes, or until pork is no longer pink, stirring occasionally. Continue to cook and stir until liquid evaporates. Remove from skillet. Repeat with remaining pork.

Add remaining 1 teaspoon sesame oil to skillet. Add bell pepper, celery, and onions. Cook 3 to 4 minutes, or until crisp-tender, stirring occasionally.

In small bowl, mix broth and cornstarch. Add to vegetables and bring to a boil. Add pork. Cook 1 minute, or until thick and bubbly. Serve over hot cooked rice or Chinese noodles, if desired.

Yield: 8 servings.

Per Serving: About 140 cal, 19 g pro, 5 g carb, 4.5 g total fat, 1 g sat fat, 45 mg chol, 650 mg sod.

# CHICKEN FAJITAS

Position multipurpose blade in work bowl. With processor running, add garlic, jalapeno, and lime peel, if desired, through small feed tube. Process until finely chopped, about 5 seconds. Add lime juice, oil, and chili powder. Process until mixed, about 5 seconds.

Exchange multipurpose blade for 4 mm slicing disc in work bowl. Add chicken. Process to slice. Remove to shallow dish or large resealable food storage plastic bag; coat chicken with marinade. Refrigerate for 1 hour.

Meanwhile, wash processor. Position 4 mm slicing disc in work bowl. Add bell peppers and onion. Process to slice.

Heat large skillet over medium-high heat. Add chicken mixture. Cook 3 to 6 minutes, or until chicken is no longer pink, stirring occasionally. With slotted spoon, remove from skillet and keep warm. Add peppers and onions to juices in skillet. Cook 3 to 4 minutes, or until crisp-tender, stirring occasionally. Serve chicken and vegetables in tortillas. Top with sour cream, if desired.

Yield: 6 servings.

Per Serving: About 360 cal, 25 g pro, 34 g carb, 14 g total fat, 3 g sat fat, 55 mg chol, 290 mg sod.

- 2 cloves garlic
- 1 jalapeno pepper, cut into quarters and seeded
- 1 (½-inch) strip lime peel, if desired
- ¼ cup fresh lime juice
- 2 tablespoons vegetable oil
- 1–½ teaspoons chili powder
- 1 package (1¼ lb) boneless skinless chicken breast halves, frozen for 1 to 1½ hours
- 1 medium red bell pepper, cut into halves lengthwise and seeded
- 1 medium green bell pepper, cut into halves lengthwise and seeded
- 1 large onion, cut into halves lengthwise
- 6 (7 to 9-inch) flour tortillas, heated according to package
- Sour cream, if desired

# INDIVIDUAL PIZZAS

## CRUST

- 2 cups water
- $\frac{1}{4}$  cup olive oil
- 2 packages active dry yeast
- 2 ounces fresh Parmesan cheese, cut into 1-inch pieces
- 6 cups all-purpose flour
- 1 tablespoon sugar
- $1\frac{1}{2}$  teaspoons salt
- 1 teaspoon dried basil, if desired
- Olive oil
- Cornmeal

## SAUCE

- $1\frac{1}{2}$ –2 cups prepared pizza, Alfredo, barbecue, or other favorite sauce

Continued...

In small saucepan, add water and  $\frac{1}{4}$  cup oil. Heat over low heat until warm, 105° F to 115° F. Stir in yeast to dissolve. Set aside.

Position multipurpose blade in work bowl. With processor running, add cheese to small feed tube. Process until chopped, 8 to 10 seconds.

Exchange multipurpose blade for dough blade in work bowl. Add flour, sugar, salt, and basil, if desired. Process until mixed, 4 to 8 seconds. With processor running, slowly add yeast mixture through small feed tube. Process  $1\frac{1}{4}$  to  $1\frac{3}{4}$  minutes; dough will form a slightly sticky ball.

Remove dough to greased bowl, turning dough to grease all sides. Cover; let rise in warm place until double in size, about 30 to 45 minutes.

Punch dough down. Shape into 12 rounds, about  $\frac{1}{4}$ -inch thick and 7 inches in diameter. Brush crusts lightly with olive oil, if desired. Grease several large baking sheets with olive oil and sprinkle lightly with cornmeal. Top each crust with about 2 tablespoons sauce,  $\frac{1}{2}$  cup meat and/or vegetables, and 3 tablespoons cheese. Bake at 425° F for 15 to 20 minutes, or until crust is golden brown, toppings are hot, and cheese is melted and lightly browned.

Continued...

Yield: 12 servings (1 pizza per serving).

Tips: Prepare crusts, sauces, and toppings, and let individuals assemble their own pizzas.

Pizza crusts may be shaped in advance and frozen. To serve, place frozen crusts on greased, cornmeal-dusted baking sheets. Thaw 15 to 20 minutes. Top and bake as directed.

Per Serving: About 460 cal, 20 g pro, 52 g carb, 19 g total fat, 7 g sat fat, 40 mg chol, 970 mg sod.

## TOPPING

- 6–7 cups cooked sausage or ground beef, sliced pepperoni, Canadian bacon, ham, shrimp, cooked chicken, roasted peppers, fresh mushrooms, olives, onion, roasted garlic, fresh basil leaves, roma tomato slices, artichoke hearts, capers, or other favorite topping
- 1½ pounds shredded mozzarella, provolone, Cheddar, Parmesan, or other favorite cheese

# LAYERED EGGPLANT AND ROASTED RED PEPPER CASSEROLE

- 1 *medium (about 1½ lb.) eggplant*
- 3 *tablespoons olive oil*
- 4 *ounces mozzarella cheese, chilled*
- 2 *ounces Parmesan cheese, room temperature*
- 1 *cup ricotta cheese*
- 1 *egg*
- ¼ *teaspoon salt*
- ¼ *teaspoon black pepper*
- 2 *cups prepared tomato basil pasta sauce, divided*
- 1 *jar (7 oz.) roasted red peppers, well drained*

Position chef's bowl and 4 mm slicing disc in work bowl. Cut eggplant into 2½-inch lengths to fit feed tube. Process to slice. Remove to greased 15x10x1-inch pan, and arrange evenly. Drizzle with olive oil. Bake at 450°F for 8 minutes, or until slightly tender.

Meanwhile, exchange slicing disc for chef's bowl and 4 mm shredding disc. Add mozzarella cheese. Process to shred. Set aside.

Position 4 mm shredding disc in work bowl. Add Parmesan cheese. Process to shred. Exchange shredding disc for multipurpose blade. Add ricotta cheese, egg, salt, and black pepper to work bowl. Process until mixed, about 10 seconds.

Pour 1 cup pasta sauce into greased 12x8x2-inch baking pan. Layer half of eggplant on top of sauce. Top with half of red peppers and half of ricotta cheese mixture. Repeat layers of eggplant, red peppers, and ricotta cheese mixture. Top with remaining 1 cup pasta sauce and mozzarella cheese. Bake at 350°F for 30 minutes, or until eggplant is tender and casserole is bubbly.

Yield: 8 servings.

Per Serving: About 250 cal, 12 g pro, 19 g carb, 14 g total fat, 6 g sat fat, 50 mg chol, 610 mg sod.

# HERBED SALMON PATTIES

## WITH CILANTRO-CAPER MAYONNAISE

### MAYONNAISE

Position mini bowl and mini blade in work bowl. With processor running, add cilantro through small feed tube. Process until chopped, 8 to 10 seconds. Scrape sides of bowl. Add mayonnaise and capers. Process until mixed, 10 to 12 seconds. Remove to small bowl; cover and refrigerate.

### PATTIES

Position multipurpose blade in work bowl. Add bread. Process until fine crumbs form, 20 to 25 seconds. Remove to small bowl. Set aside.

With processor running, add tarragon, lemon peel, and onions through small feed tube. Process until chopped, 5 to 8 seconds. Scrape sides of bowl. Add celery. Pulse 2 to 3 times, about 2 seconds each time, or until chopped. Add egg, lemon juice, salt, pepper, and  $\frac{3}{4}$  cup bread crumbs. Pulse 2 to 3 times, about 2 seconds each time, or until mixed. Add salmon. Pulse 5 to 6 times, about 2 seconds each time, or just until mixed.

Shape into 6 patties,  $\frac{1}{2}$ -inch thick. Coat both sides of patties with remaining  $\frac{1}{4}$  cups bread crumbs and press into patties.

In large skillet over medium heat, heat 1 tablespoon oil and 1 tablespoon butter until hot. Add patties in batches, if necessary. Cook 5 to 6 minutes per side, or until golden brown, turning once. Add additional oil and butter if necessary. Serve with Cilantro-Caper Mayonnaise.

Yield: 6 servings.

Tip: Mayonnaise and uncooked patties may be made and refrigerated up to 1 day in advance. Cook patties just before serving.

Per Serving: About 400 cal, 28 g pro, 7 g carb, 28 g total fat, 5 g sat fat, 120 mg chol, 390 mg sod.

### MAYONNAISE

- 3 *tablespoons lightly packed fresh cilantro leaves*
- $\frac{1}{2}$  *cup mayonnaise or salad dressing*
- 1 *tablespoon capers, drained*

### PATTIES

- 2 *cups French, Italian or sour dough bread cubes, divided*
  - 1 *tablespoon fresh tarragon leaves*
  - 2 *strips lemon peel, yellow portion only*
  - 3 *green onions, cut into 1-inch pieces*
  - 1 *rib celery, cut into 1-inch pieces*
  - 1 *egg, beaten*
  - 1 *tablespoon lemon juice*
  - $\frac{1}{4}$  *teaspoon salt*
  - $\frac{1}{8}$  *teaspoon black pepper*
  - $1\frac{1}{2}$  *fresh salmon fillets\*, grilled or broiled, and skin removed*
  - 1–2 *tablespoons olive oil*
  - 1–2 *tablespoons butter or margarine*
- \* Three, 7-ounce cans salmon, drained, may be substituted, if desired.

# CHICKEN SATAY

## WITH PEANUT SAUCE

### CHICKEN

- 4 *cloves garlic*
- 2 *teaspoons coarsely chopped gingerroot*
- $\frac{1}{2}$  *cup soy sauce*
- 3 *tablespoons peanut or vegetable oil, divided*
- 2 *teaspoons brown sugar*
- 2 *pounds chicken breast tenders*

### SAUCE

- $\frac{3}{4}$  *cup coconut milk*
- $\frac{2}{3}$  *cup peanut butter*
- $\frac{1}{4}$  *cup soy sauce*
- $\frac{3}{4}$ –1 *teaspoon red curry paste*

### CHICKEN

Position multipurpose blade in work bowl. With processor running, add garlic and gingerroot through small feed tube. Process until chopped, 5 to 10 seconds. Add soy sauce, 2 tablespoons oil, and brown sugar. Process until blended and sugar dissolves, 15 to 20 seconds. Remove to plastic resealable food storage bag or shallow dish. Add chicken; toss to coat. Marinate  $\frac{1}{2}$  hour at room temperature or at least 2 hours in refrigerator. Remove chicken from marinade, reserving marinade.

Thread chicken tenders on soaked wooden or oiled metal skewers. Grill over medium-hot coals or broil on oiled broiler pan 4 to 6 inches from heat for 12 to 16 minutes, or until thoroughly cooked, turning once. Brush with any remaining marinade once during cooking, if desired. Serve with warm or room temperature Peanut Sauce.

### SAUCE

Position multipurpose blade in work bowl. Add all ingredients. Process until blended, 5 to 10 seconds.

Yield: 8 servings.

Per Serving: About 250 cal, 24 g pro, 5 g carb, 16 g total fat, 3.5 g sat fat, 45 mg chol, 1070 mg sod.

# WHEAT BOULES

Combine milk, water,  $\frac{1}{4}$  cup butter, and honey in small saucepan. Heat over low heat until warm, 105° F to 115° F. Stir in yeast to dissolve. Set aside.

Position dough blade in work bowl. Add all-purpose flour, whole wheat flour, walnuts,  $\frac{1}{4}$  cup wheat germ, and salt. Process until mixed, 10 to 12 seconds. With processor running, slowly add yeast mixture through small feed tube. Process 1 to 1 $\frac{1}{4}$  minutes; dough will form a slightly sticky ball.

Remove dough to greased bowl, turning dough to grease all sides. Cover; let rise in warm place until double in size, about 45 to 60 minutes.

Punch dough down. On greased baking sheet, form two 6 to 6 $\frac{1}{2}$ -inch balls\*. Make 3 shallow slashes across tops. Cover; let rise in warm place until double in size, about 30 to 45 minutes. If desired, brush with melted butter and sprinkle with wheat germ.

Bake at 375° F for 30 to 40 minutes, or until loaves are brown and sound hollow when tapped. Cool on wire rack.

Yield: 24 servings (12 slices per boule).

Per Serving: About 150 cal, 4 g pro, 24 g carb, 4 g total fat, 1.5 g sat fat, 5 mg chol, 105 mg sod.

\*Dough may be shaped into loaves and placed in two greased 8 $\frac{1}{2}$ x4 $\frac{1}{2}$ x2 $\frac{1}{2}$ -inch loaf pans.

- 1 cup milk
- $\frac{2}{3}$  cup water
- $\frac{1}{4}$  cup butter or margarine
- $\frac{1}{3}$  cup honey
- 2 packages active dry yeast
- 3 cups all-purpose flour
- 2 cups whole wheat flour
- $\frac{1}{2}$  cup coarsely chopped walnuts
- $\frac{1}{4}$  cup wheat germ
- 1 teaspoon salt
- Melted butter, if desired
- Wheat germ, if desired

# SUNDAY DINNER ROLLS

- 1½ cups milk
- ½ cup water
- ¼ cup butter or margarine
- 2 packages active dry yeast
- 5½ cups all-purpose flour
- 1 tablespoon sugar
- 2 teaspoons salt
- Melted butter or beaten egg,  
if desired*

Combine milk, water, and ¼ cup butter in small saucepan. Heat over low heat until warm, 105° F to 115° F. Stir in yeast to dissolve.

Position dough blade in work bowl. Add flour, sugar, and salt. Process until mixed, 4 to 5 seconds. With processor running, slowly add yeast mixture through small feed tube. Process 1 to 1¼ minutes; dough will form a slightly sticky ball.

Remove dough to greased bowl, turning dough to grease all sides. Cover, let rise in warm place until double in size, about 45 to 60 minutes.

Punch dough down. Divide into 30 equal-sized pieces. Shape each into a smooth ball; place 1 inch apart on greased baking sheets. Brush with melted butter or egg, if desired. Cover; let rise in a warm place until double, about 45 to 60 minutes.

Bake at 375° F for 15 to 20 minutes, or until rolls are deep golden brown and sound hollow when tapped. Cool on rack.

Yield: 30 servings (1 roll per serving).

Per Serving: About 100 cal, 3 g pro, 18 g carb, 2 g total fat, 1 g sat fat, 5 mg chol, 160 mg sod.

**VARIATION: CLOVER LEAF ROLLS**

Divide dough into 30 equal-sized balls. Divide each ball into 3 smaller balls; place the 3 balls into a greased muffin cup. Repeat with remaining balls. Brush with melted butter, if desired. Proof and bake as directed above.

Yield: 30 servings (1 roll per serving).

Per Serving: About 100 cal, 3 g pro, 18 g carb, 2 g total fat, 1 g sat fat, 5 mg chol, 160 mg sod.

**VARIATION: CRESCENT-SHAPED ROLLS**

Divide dough into thirds. Roll  $\frac{1}{3}$  of dough into  $\frac{1}{4}$ -inch thick circle. Spread with 1 tablespoon softened butter. Cut into 12 wedges. Roll each wedge from wide end to pointed end; bend ends inward slightly to shape. Brush with melted butter or egg, if desired. Place on greased baking sheets. Repeat twice with remaining dough. Proof and bake as directed above.

Yield: 36 servings (1 roll per serving).

Per Serving: About 90 cal, 3 g pro, 15 g carb, 2.5 g total fat, 1.5 g sat fat, 5 mg chol, 135 mg sod.

# WHITE BREAD

- 1½ cups water*
- ½ cup milk*
- ¼ cup butter or margarine*
- 2 packages active dry yeast*
- 6 cups all-purpose flour*
- 2 tablespoons sugar*
- 2 teaspoons salt*

Combine water, milk, and butter in small saucepan. Heat over low heat until warm, 105°F to 115°F. Stir in yeast to dissolve. Set aside.

Position dough blade in work bowl. Add flour, sugar, and salt. Process until mixed; 4 to 5 seconds. With processor running, slowly add yeast mixture through small feed tube. Process

1 to 1¼ minutes; dough will form a slightly sticky ball.

Remove dough to greased bowl, turning dough to grease all sides. Cover; let rise in warm place until double in size, about 45 to 60 minutes.

Punch dough down. Shape into 2 loaves, and place in greased 8½x4½x2½-inch loaf pans. Cover; let rise in warm place until double in size, about 30 to 45 minutes.

Bake at 375°F for 35 to 40 minutes, or until loaves are deep golden brown and sound hollow when tapped. Remove loaves from pans immediately. Cool on rack.

Yield: 24 servings (12 slices per loaf).

Per Servings: About 130 cal, 4 g pro, 24 g carb, 2.5 g total fat, 1.5 g sat fat, 5 mg chol, 200 mg sod.

**VARIATION: CINNAMON BREAD**

After first rising, divide dough into 2 pieces. Roll out one piece of dough into a 15x9-inch rectangle. Spread with 1 tablespoon soft butter or margarine. Sprinkle with 3 tablespoons sugar and 1 teaspoon cinnamon. Starting at short end, roll firmly to form loaf. Pinch to seal ends and bottom seam. Place seam side down in 8½x4½x2½-inch greased loaf pan. Repeat with remaining dough. Proceed as directed for white bread.

Yield: 24 servings (12 slices per loaf).

Per Serving: About 150 cal, 4 g pro, 27 g carb, 3.5 g total fat, 2 g sat fat, 10 mg chol, 200 mg sod.

**VARIATION: PARMESAN PEPPER BREAD**

After first rising, divide dough into 2 pieces. Roll out one piece of dough into a 15x9-inch rectangle. Spread with 1 tablespoon soft butter or margarine. Sprinkle with ⅓ cup freshly grated Parmesan cheese and ½ teaspoon coarsely ground black pepper. Starting at short end, roll firmly to form loaf. Pinch to seal ends and bottom seam. Place seam side down in 8½x4½x2½-inch greased loaf pan. Repeat with remaining dough. Proceed as directed for white bread.

Yield: 24 servings (12 slices per loaf).

Per Serving: About 150 cal, 5 g pro, 24 g carb, 4 g total fat, 2.5 g sat fat, 10 mg chol, 250 mg sod.

# CRANBERRY-WALNUT SCONES

- 4 cups all-purpose flour
- 4 teaspoons baking powder
- $\frac{1}{2}$  teaspoon cinnamon
- $\frac{1}{4}$  teaspoon nutmeg
- $\frac{1}{2}$  teaspoon salt
- 4 tablespoons sugar, divided
- $\frac{2}{3}$  cup cold butter or margarine, cut into  $\frac{1}{2}$ -inch pieces
- 1 egg
- $1\frac{1}{3}$  cups whipping cream
- 1 cup dried cranberries
- $\frac{3}{4}$  cup walnut halves or pieces

Position multipurpose blade in work bowl. Add flour, baking powder, cinnamon, nutmeg, salt, and 3 tablespoons sugar. Process until thoroughly mixed, about 10 seconds. Add butter. Pulse 5 times, about 2 seconds each time, or until mixture is crumbly.

In small bowl, combine egg and whipping cream. Pour 1 cup of cream mixture over flour mixture in work bowl. Pulse 5 times, about 2 seconds each time. Sprinkle cranberries and nuts over flour mixture. Pour remaining cream mixture over nuts. Pulse 5 to 6 times, about 2 seconds each time, or until dry ingredients are moistened.

Turn onto lightly floured surface. Shape into large ball until dough sticks together. Pat into two 7-inch circles, about 1-inch thick. Sprinkle with remaining 1 tablespoon sugar evenly divided between circles. Cut each into 8 wedges. Place on greased baking sheet, separating pieces slightly. Bake at 400°F for 16 to 20 minutes, or until light golden brown and firm when tapped on top. Serve warm.

Yield: 16 scones (1 scone per serving).

Per Serving: About 310 cal, 5 g pro, 34 g carb, 18 g total fat, 9 g sat fat, 60 mg chol, 210 mg sod.

# BAKING POWDER BISCUITS

Position multipurpose blade in work bowl. Add flour, baking powder, and salt. Process until well mixed, about 10 seconds. Add shortening. Pulse 5 to 6 times, about 1 second each time, or until mixture is crumbly. Add milk. Pulse 5 to 6 times, about 1 second each time, or until dry ingredients are moistened. Mixture will not form a ball; do not overmix.

Place dough on floured surface. Pat or roll to ½-inch thick. Cut with floured 2-inch round cutter. If desired, gently re-roll dough pieces once to cut 2 to 3 additional biscuits. Place on ungreased baking sheet. Brush with melted butter, if desired. Bake at 450°F for 8 to 10 minutes, or until light golden brown.

Yield: 14 biscuits (1 biscuit per serving).

Per Serving: About 150 cal, 3 g pro, 18 g carb, 7 g total fat, 2 g sat fat, 0 mg chol, 270 mg sod.

- 2⅔ cups all-purpose flour*
- 4 teaspoons baking powder*
- ¾ teaspoon salt*
- ½ cup shortening*
- ¾ cup milk*
- 2 tablespoons melted butter, if desired*

# INDIVIDUAL CRANBERRY PEAR CRISPS

## TOPPING

- $\frac{1}{3}$  cup all-purpose flour
- $\frac{1}{3}$  cup packed brown sugar
- 1 teaspoon cinnamon
- $\frac{1}{4}$  teaspoon salt
- $\frac{1}{3}$  cup butter or margarine, cut into chunks
- 1 cup rolled oats

## FRUIT

- $\frac{3}{4}$  cup granulated sugar
- 1 tablespoon all-purpose flour
- $1\frac{1}{2}$  cups fresh or frozen cranberries
- 4 large pears, peeled, cut into halves, and cored

Position multipurpose blade in work bowl. Add flour, brown sugar, cinnamon, and salt. Process until blended, about 3 seconds. Add butter. Pulse 2 to 3 times, about 5 seconds each time, or until crumbly. Add oats. Pulse 2 times, about 2 seconds each time, or until mixed. Remove to medium mixing bowl. Set aside.

Position multipurpose blade in work bowl. Add granulated sugar, flour, and cranberries. Pulse 2 to 3 times, about 2 seconds each time, or until coarsely chopped. Exchange multipurpose blade for 4 mm slicing disc. Add pears. Process to slice. Remove to large mixing bowl; toss to mix.

Divide pear mixture evenly among eight, 10-ounce buttered ramekins or custard cups. Add topping, dividing evenly among ramekins. Place ramekins on large baking sheet. Bake at 350° F for 45 to 55 minutes, or until pears are tender and topping is golden brown. Serve with ice cream, if desired.

Yield: 8 servings.

Per Serving: About 320 cal, 3 g pro, 60 g carb, 9 g total fat, 5 g sat fat, 20 mg chol, 80 mg sod.

## VARIATION: INDIVIDUAL CRANBERRY APPLE CRISPS

Substitute 4 apples for pears.

Yield: 8 servings.

Per Serving: About 300 cal, 3 g pro, 55 g carb, 9 g total fat, 5 g sat fat, 20 mg chol, 75 mg sod.

# VELVETY SOUR CREAM CHEESECAKE

Position multipurpose blade in work bowl. Add crackers. Pulse 4 to 5 times, 6 to 7 seconds each time, or until fine crumbs. With processor running, slowly add butter through small feed tube. Process until combined, 10 to 15 seconds. Press in bottom and 1½ inches up sides of 10-inch springform pan. Bake at 350°F for 8 to 10 minutes, or until set. Cool.

Wipe out work bowl. Position multipurpose blade in work bowl. Add eggs. Process until blended, about 3 seconds. Add remaining ingredients. Process until smooth and blended, about 15 seconds, scraping sides of bowl if necessary.

Pour into crust. Bake at 350°F for 50 to 60 minutes, or until edges are set and center is soft-set. Cool 1 to 2 hours on rack. Refrigerate at least 4 hours. Remove sides of pan to slice. If desired, serve with favorite fruit coulis, pie filling, or chocolate or fruit sauce.

Yield: 16 servings.

Per Serving: About 370 cal, 6 g pro, 26 g carb, 28 g total fat, 18 g sat fat, 110 mg chol, 290 mg sod.

## CRUST

30 squares (2½ in. each) graham crackers, broken

½ cup butter or margarine, melted

## FILLING

3 eggs

3 packages (8 oz. each) cream cheese, softened

2 cups sour cream

1 cup sugar

¼ teaspoon salt

2 teaspoons vanilla

# FRESH FRUIT TART

## CRUST

- 1 *cup all-purpose flour*
- 2 *teaspoons sugar*
- $\frac{1}{4}$  *teaspoon salt*
- $\frac{1}{4}$  *cup cold butter, cut into 1-inch pieces*
- 1 *tablespoon cold shortening*
- 1 *egg yolk*
- 2 *tablespoons ice water*
- 1 *teaspoon lemon juice*
- 1 *egg, blended with 1 tablespoon water*

## FILLING

- $\frac{1}{4}$  *cup sugar*
- 1 *tablespoon cornstarch*
- $\frac{1}{8}$  *teaspoon salt*
- $\frac{3}{4}$  *cup half-and-half*
- 2 *egg yolks, beaten*
- $\frac{1}{2}$  *teaspoon vanilla*

Continued...

Position multipurpose blade in work bowl. Add flour, sugar, and salt. Process until mixed, about 2 seconds. Add butter and shortening. Pulse 3 to 4 times, 2 to 3 seconds each time, or until crumbly. In small bowl, blend egg yolk, 2 tablespoons water, and lemon juice. Sprinkle evenly over flour mixture. Pulse 1 to 3 times, 2 to 3 seconds each time, or until dry ingredients are moistened and crumbly.

On lightly floured surface, shape into a ball. Roll into a circle 2 inches larger than inverted 10-inch tart pan. Fit into tart pan, being careful not to stretch dough. Trim edges of crust. Prick shell thoroughly with fork. Bake at 425° F for 8 to 12 minutes, or until light golden brown. Brush shell with egg and water mixture to seal holes. Bake for 1 minute to set egg. Cool completely.

In small saucepan over medium heat, combine sugar, cornstarch, and salt. Add half-and-half and egg yolks. Cook and stir until very thick. Remove from heat. Add vanilla. Whisk until smooth. Cool completely.

Continued...

Meanwhile, wash processor. Position chef's bowl and 4 mm slicing disc in work bowl. Add strawberries. Process to slice. Set aside. Position 4 mm slicing disc in work bowl. Add peach. Process to slice.

Spread custard mixture in shell. Arrange sliced fruit on custard. Carefully brush with melted jelly to cover fruit completely. Refrigerate at least 30 minutes before serving.

Yield: 8 servings.

Tip: Tart is best served the same day it is made.

Per Serving: About 230 cal, 4 g pro, 27 g carb, 12 g total fat, 6 g sat fat, 125 mg chol, 130 mg sod.

## TOPPING

- 1 cup fresh strawberries, hulled
- 1 medium peach, peeled, cut into halves, and pit removed
- 2 tablespoons apple jelly, melted

# APPLE PIE

- 2 *pastry crusts (see page 87)*
- 2 *tablespoons crystallized ginger, if desired*
- $\frac{1}{3}$  *cup granulated sugar*
- $\frac{1}{4}$  *cup packed brown sugar*
- 3 *tablespoons all-purpose flour*
- 1 *teaspoon cinnamon*
- $\frac{1}{8}$  *teaspoon nutmeg*
- 6 *medium to large crisp apples (Gala or Rome), peeled, cored, and cut into halves lengthwise*
- 1 *tablespoon butter or margarine, cut up*
- 2 *teaspoons milk, if desired*
- 1 *tablespoon granulated sugar, if desired*

Prepare pastry crust as directed in recipe. Fit one crust into 9-inch pie plate. Cover both halves of crust with plastic wrap. Set aside.

Position multipurpose blade in work bowl. With processor running, add ginger through small feed tube. Process until chopped, 10 to 15 seconds. Add  $\frac{1}{3}$  cup granulated sugar, brown sugar, flour, cinnamon, and nutmeg. Process until mixed, 2 to 3 seconds.

Exchange multipurpose blade for 4 mm slicing disc in work bowl. Add apples, cutting to fit feed tube if necessary. Process to slice. Remove apples and sugar mixture to large mixing bowl. Stir gently to coat. Add mixture to unbaked pie shell. Dot with butter.

Cover with top crust. Seal edge and flute. If desired, brush with milk and sprinkle with sugar. Cut 6 to 8 slits in top crust, allowing steam to escape. Bake at 425°F for 60 to 70 minutes, or until crust is golden brown and filling begins to bubble in center. Cover pie with foil, if necessary, to prevent over-browning. Cool on rack.

Yield: 8 servings.

Per Serving: About 380 cal, 4 g pro, 52 g carb, 18 g total fat, 7 g sat fat, 15 mg chol, 220 mg sod.

# PASTRY CRUST

Position multipurpose blade in work bowl. Add flour and salt. Process until mixed, about 2 seconds. Add shortening and butter. Pulse 3 to 4 times, 2 to 3 seconds each time, or until crumbly. Sprinkle minimum amount of water evenly over mixture. Pulse 1 to 3 times, 2 to 3 seconds each time, or until mixture pulls away from sides of bowl and dry ingredients are moistened. Add additional water if necessary.

On lightly floured surface, shape into a ball (2 balls for 2-crust pie). Roll each ball into a circle 2 inches larger than inverted pie plate. Fit into pie plate. Proceed as directed in pie recipe.

To bake single crust shell, flute edges of crust. Prick shell thoroughly with fork. Bake at 425°F for 9 to 12 minutes, or until light golden brown. To bake 2-crust pie, follow directions in pie recipe.

Yield: 1 pie (8 servings).

Tip: To make 4 crusts, double 2-crust recipe. Roll out extra crusts and place in pie plates. Store in airtight container and freeze.

Per Serving (one crust): About 120 cal, 2 g pro, 11 g carb, 8 g total fat, 2.5 g sat fat, 5 mg chol, 75 mg sod.

Per Serving (two crusts): About 260 cal, 4 g pro, 23 g carb, 17 g total fat, 6 g sat fat, 10 mg chol, 220 mg sod.

## ONE CRUST

- 1 cup all-purpose flour
- $\frac{1}{4}$  teaspoon salt
- $\frac{1}{4}$  cup cold shortening
- 1 tablespoon cold butter or margarine, cut up
- 2–4 tablespoons ice water

## TWO CRUSTS

- 2 cups all-purpose flour
- $\frac{3}{4}$  teaspoon salt
- $\frac{1}{2}$  cup cold shortening
- 3 tablespoons cold butter or margarine, cut up
- 5–7 tablespoons ice water

# 3-LAYER CARROT CAKE

WITH CREAM CHEESE FROSTING

## CAKE

$1\frac{1}{2}$  pounds (8–11 medium) carrots

$2\frac{2}{3}$  cups sugar

$\frac{3}{4}$  cup vegetable oil

4 eggs

$2\frac{1}{2}$  teaspoons vanilla

3 cups all-purpose flour

$2\frac{1}{2}$  teaspoons baking soda

$\frac{3}{4}$  teaspoon salt

$2\frac{1}{2}$  teaspoons cinnamon

$\frac{1}{2}$  teaspoon nutmeg

$\frac{1}{2}$  cup golden raisins

$\frac{1}{2}$  cup flaked coconut

$\frac{3}{4}$  cup pecan halves or pieces

## CAKE

Position chef's bowl and 4 mm shredding disc in work bowl. Add carrots, cutting to fit feed tube if necessary. Process to shred. (Yield should be about 4 cups.)

Exchange chef's bowl and shredding disc for multipurpose blade in work bowl. Add sugar, oil, eggs, vanilla, and carrots. Process until thoroughly mixed, 8 to 10 seconds. Scrape sides of bowl. Process 25 to 30 seconds longer to dissolve sugar. Spread all remaining cake ingredients evenly over carrot mixture in bowl. Pulse 3 to 4 times, 2 to 3 seconds each time, or until just blended.

Pour batter evenly into 3 greased and floured 9-inch round cake pans (about  $2\frac{1}{3}$  cups batter per pan). Bake at 350° F for about 30 minutes, or until wooden pick inserted in center comes out clean. If baking on 2 racks, rearrange pans half way through. Cool in pans on rack for 10 minutes. Remove layers from pans; cool completely. Frost with Cream Cheese Frosting.

## FROSTING

Position multipurpose blade in work bowl. Add powdered sugar, cream cheese, and butter. Process until thoroughly mixed, about 20 seconds. With processor running, add vanilla and 1 teaspoon half-and-half through small feed tube. Process until mixed, about 10 seconds. With processor running, if necessary, add remaining 1 teaspoon half-and-half a little at a time until frosting is spreading consistency. Spread between cooled layers and on sides of cake. Sprinkle pecans on top of cake, if desired. Store in refrigerator.

Yield: 16 servings.

Tip: If desired, freeze individual cake layers in sealed storage containers until ready to use. Thaw and frost.

Per Serving: About 670 cal, 6 g pro, 107 g carb, 26 g total fat, 10 g sat fat, 80 mg chol, 400 mg sod.

## FROSTING

- 6<sup>1</sup>/<sub>3</sub> cups powdered sugar*
- 1 package (8 oz.) cream cheese, cut into 8 pieces*
- <sup>1</sup>/<sub>3</sub> cup butter or margarine, softened*
- 1<sup>1</sup>/<sub>4</sub> teaspoons vanilla*
- 1–2 teaspoons half-and-half or milk*
- <sup>1</sup>/<sub>3</sub> cup pecan halves or pieces, if desired*

# TROPICAL LEMON MERINGUE PIE

1 9-inch pastry crust, baked and cooled (see page 87)

## FILLING

$\frac{1}{4}$  cups sugar, divided

4 strips ( $\frac{1}{2}$ -in. each) lemon peel, yellow portion only

3 strips ( $\frac{1}{2}$ -in. each) lime peel, green portion only

$\frac{1}{4}$  cup cornstarch

$\frac{1}{8}$  teaspoon salt

$\frac{1}{3}$  cup fresh lemon juice

3 egg yolks, beaten

$1\frac{2}{3}$  cups water

## MERINGUE

4 egg whites

$\frac{1}{2}$  teaspoon cream of tartar

$\frac{1}{8}$  teaspoon salt

$\frac{1}{3}$  cup sugar

Position mini bowl and mini blade in work bowl. With processor running, add 1 tablespoon sugar, lemon and lime peel through small feed tube. Process until peel is chopped, 5 to 10 seconds. Remove to small bowl; set aside.

Exchange mini bowl and mini blade for multipurpose blade in work bowl. Add remaining 1 cup plus 3 tablespoons sugar, cornstarch, and  $\frac{1}{8}$  teaspoon salt. Process until mixed, 5 to 8 seconds. With processor running, add lemon juice, egg yolks, and water through small feed tube. Process until blended, 3 to 5 seconds. Remove to medium saucepan. Set aside.

Wash processor. Position egg whip attachment in work bowl. Add egg whites, cream of tartar, and  $\frac{1}{8}$  teaspoon salt. Process until foamy, 20 to 25 seconds. With processor running, gradually add  $\frac{1}{3}$  cup sugar through small feed tube. Process until glossy and stiff peaks form, about 5 minutes. Set aside.

In medium saucepan over medium heat, cook and stir reserved filling mixture until very thick. Stir in reserved lemon and lime peel. Remove from heat, and pour into prepared pie crust. Spread meringue over warm filling, sealing meringue to edges of crust. Bake at 325°F about 15 minutes, or until light golden. Cool completely.

Yield: 8 servings.

Per Serving: About 320 cal, 5 g pro, 56 g carb, 9 g total fat, 3 g sat fat, 80 mg chol, 180 mg sod.

# CHOCOLATE-ORANGE MOUSSE

Position multipurpose blade in work bowl. Add chocolate chips, granulated sugar, and orange peel. Process until chocolate and peel are finely chopped, about 35 seconds. Set aside.

In small saucepan over medium heat, heat milk until very hot but not boiling. In small bowl, sprinkle gelatin over water. Let stand 10 to 15 seconds to soften. Add to hot milk. Reduce heat to medium-low. Cook and stir until gelatin dissolves.

With processor running, slowly add hot milk mixture to chocolate mixture through small feed tube. Process until smooth, 10 to 20 seconds, scraping sides of bowl if necessary. Remove to medium mixing bowl. Refrigerate about 30 minutes.

Meanwhile, wash processor. Position egg whip attachment in work bowl. Add whipping cream and powdered sugar. Process until soft peaks form, 1½ to 2 minutes. Fold into cooled chocolate mixture. Refrigerate 15 to 20 minutes to thicken. Spoon into individual dessert dishes. Refrigerate until serving.

Yield: 4 servings (½ cup per serving).

Tip: Garnish with orange twists or mandarin orange segments, if desired.

Per Serving: About 400 cal, 2 g pro, 39 g carb, 27 g total fat, 16 g sat fat, 85 mg chol, 20 mg sod.

- ½ cup semisweet chocolate chips*
- ¼ cup granulated sugar*
- 6 strips orange peel, orange portion only*
- ½ cup milk*
- 1 teaspoon unflavored gelatin*
- 1 tablespoon water*
- 1 cup whipping cream*
- ¼ cup powdered sugar*

# PECAN SHORTBREAD BARS

## CRUST

- 2 cups all-purpose flour
- $\frac{2}{3}$  cup powdered sugar
- $\frac{1}{8}$  teaspoon salt
- 1 strip orange peel, orange portion only
- 1 cup butter or margarine, cut into 1-inch pieces

## FILLING

- $\frac{2}{3}$  cup butter or margarine
- $\frac{1}{3}$  cup packed brown sugar
- $\frac{1}{4}$  cup maple syrup
- $\frac{1}{8}$  teaspoon salt
- 1 teaspoon vanilla
- 1 cup pecan pieces

Position multipurpose blade in work bowl. Add flour, powdered sugar,  $\frac{1}{8}$  teaspoon salt, and orange peel. Process until peel is finely chopped, 10 to 15 seconds. Add 1 cup butter. Process until soft dough forms, 40 to 45 seconds. Press in bottom and  $\frac{1}{2}$  inch up sides of ungreased 13x9x2-inch baking pan. Bake at 350° F for 20 to 25 minutes, or until set and light golden. Cool completely.

Meanwhile, in medium saucepan over medium heat, combine  $\frac{2}{3}$  cup butter, brown sugar, maple syrup, and  $\frac{1}{8}$  teaspoon salt. Cook, stirring constantly, until mixture boils. Boil 1 minute without stirring. Remove from heat. Add vanilla and pecans. Stir until blended. Pour into prepared crust and spread evenly. Let cool completely.

Yield: 32 bars (1 bar per serving).

Per Serving: About 160 cal, 1 g pro, 13 g carb, 12 g total fat, 6 g sat fat, 25 mg chol, 20 mg sod.

**KitchenAid**<sup>®</sup>  
PRO LINE™ SERIES

# WARRANTY AND SERVICE INFORMATION

## Warranty Information Section Contents

Warranty for the U.S. ....	94
Warranty for Puerto Rico .....	95
Arranging for Hassle-Free Replacement .....	95
Ordering Accessories & Replacement Parts .....	96
Arranging for Service After the Warranty Expires .....	96
Arranging for Service Outside the U.S. & Puerto Rico .....	97

FOOD PROCESSOR **WARRANTY**  
 FOR THE **50 UNITED STATES**  
 AND DISTRICT OF COLUMBIA

This warranty extends to the purchaser and any succeeding owner for PRO LINE™ Series Food Processors operated in the 50 United States and District of Columbia.

<b>Length of Warranty:</b>	<b>KitchenAid Will Pay For Your Choice of:</b>	<b>KitchenAid Will Not Pay For:</b>
<p>Two Year Full Warranty for Household Use, from date of purchase.</p>	 <p>Hassle-Free Replacement of your Food Processor. See "Arranging for Hassle-Free Replacement" for details, or call the KitchenAid Customer Satisfaction Center toll-free at <b>1-800-541-6390</b>.                      OR                      The replacement parts and repair labor costs to correct defects in materials and workmanship. Service must be provided by an Authorized KitchenAid Service Center. See the KitchenAid® PRO LINE™ Series Food Processor Warranty for Puerto Rico for details on how to arrange for service.</p>	<p>A. Repairs when the Food Processor is used in other than normal single family home use.                      B. Damage resulting from accident, alteration, misuse or abuse.                      C. Any shipping or handling costs to deliver your Food Processor to an Authorized Service Center.                      D. Replacement parts or repair labor costs for Food Processors operated outside the 50 United States and District of Columbia.</p>

**KITCHENAID DOES NOT ASSUME ANY RESPONSIBILITY FOR INCIDENTAL OR CONSEQUENTIAL DAMAGES.** Some states do not allow the exclusion or limitation of incidental or consequential damages, so this exclusion may not apply to you. This warranty gives you specific legal rights and you may also have other rights which vary from state to state.

# FOOD PROCESSOR **WARRANTY** FOR **PUERTO RICO**

A limited two year warranty extends to the purchaser and any succeeding owner for PRO LINE™ Series Food Processors operated in Puerto Rico. During the warranty period, all service must be handled by an Authorized KitchenAid Service Center.

Please bring the Food Processor, or ship it prepaid and insured, to the nearest Authorized Service Center. Call toll-free **1-800-541-6390** Monday through Friday, 8 a.m. to 8 p.m. (Eastern Time), or Saturday, 10 a.m. to 5 p.m. to learn the location of a Service Center near you. Your repaired Food Processor will be returned to you prepaid and insured.

## **ARRANGING** FOR **HASSLE-FREE** REPLACEMENT

**IF YOU RESIDE IN THE 50 UNITED STATES** and your KitchenAid® PRO LINE™ Series Food Processor should fail within two years of ownership, simply call our toll-free Customer Satisfaction Center at **1-800-541-6390** Monday through Friday, 8 a.m. to 8 p.m. (Eastern Time), or Saturday, 10 a.m. to 5 p.m. Give the consultant your complete shipping address. (No P.O. Box Numbers, please.)

When you receive your replacement PRO LINE™ Series Food Processor, use the carton and packing materials to pack-up your “failed” Food Processor. In the carton, include your name and address on a sheet of paper along with a copy of the proof of purchase (register receipt, credit card charge slip, etc.).

KitchenAid will arrange to deliver an identical or comparable replacement to your door free of charge and arrange to have your “failed” Food Processor returned to us. Your replacement unit will also be covered by our two year full warranty.

# ORDERING **ACCESSORIES** AND **REPLACEMENT** PARTS

To order accessories or replacement parts for your Food Processor, call toll-free **1-800-541-6390** Monday through Friday, 8 a.m. to 8 p.m. (Eastern Time), or Saturday, 10 a.m. to 5 p.m., or write to:

Customer Satisfaction Center, KitchenAid Portable Appliances,  
P.O. Box 218, St. Joseph, MI 49085-0218.

# ARRANGING FOR **SERVICE** AFTER THE **WARRANTY** EXPIRES

For service information, call toll-free **1-800-541-6390** Monday through Friday, 8 a.m. to 8 p.m. (Eastern Time), or Saturday, 10 a.m. to 5 p.m., or write to:

Customer Satisfaction Center, KitchenAid Portable Appliances,  
P.O. Box 218, St. Joseph, MI 49085-0218.

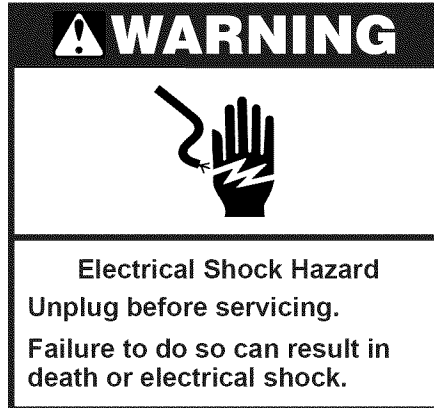

ARRANGING FOR **SERVICE** OUTSIDE  
THE **50 UNITED STATES**  
AND PUERTO RICO

Consult your local KitchenAid dealer or the store where you purchased your PRO LINE™ Series Food Processor for information on how to obtain service.