



AWRT10RF Wireless Radiant Thermostat

Installation & Operation Instruction Manual



As of February 21, 2019

Table of Contents

1.0	Introduction	
1.1	Box Contents	4
1.2	Using this Manual	4
1.3	Product Safety Information	5
1.4	SALUS Smart Home Application	5
1.5	SALUS Wireless System Constraints	5
2.0	AWRT10RF Thermostat Installation Flow Charts	
2.0	Installation with Internet Connection	6
2.1	Installation without Internet Connection	7
3.0	AWRT10RF Thermostat Installation	
	Mounting & Optional External Temperature Sensor Wiring	8
4.0	AWRT10RF Thermostat Display & Keypad	
4.1	Home Screen and Key Functions	10
4.2	Display Screen Boot Sequence	10
5.0	Pairing with Wireless Devices using SG888ZB Gateway	
5.1	Relay Controller (AKL01PRF/AKL04PRF/AK06PRF/AKL08RF)	11
5.2	Radiator Valves (ARV10RFM/AVA10M30RF)	15
5.3	Receiver (AX10RF – RX1)	19
5.4	Receiver (AX10RF – RX1)	22
6.0	SALUS Smart Home Application	
6.1	Parameter Settings	26
6.2	Schedule Setup	26
6.3	Remote Operation	27
7.0	Pairing with Wireless Devices using AC10RF Coordinator	
7.1	Relay Controller (AKL01PRF/AKL04PRF/AK06PRF/AKL08RF)	29
7.2	Radiator Valves (ARV10RFM/AVA10M30RF)	32
7.3	Receiver (AX10RF – RX1)	35
7.4	Receiver (AX10RF – RX2)	37
8.0	AWRT10RF Thermostat Settings & Parameters	
8.1	Parameter & Settings Adjustment using Display & Keypad	39
8.2	Thermostat Settings Table	40
8.3	Thermostat Parameter Table	41
8.4	Schedule Setup using Display & Keypad	43

Table of Contents

9.0 AWRT10RF Thermostat Operation – Display/Keypad

9.1 - Setting the HVAC Mode using the Display & Keypad	45
9.2 - Setting the Temperature Setpoint in Non-programmable Mode.....	45
9.3 - Overriding Scheduled Temperature using the Display & Keypad	46

10.0 Troubleshooting

10.1 - Error Messages.....	47
10.2 - Reading Multiple Error Messages	48
10.3 - External Sensor Resistance Graph.....	48

11.0 Technical Specifications

Thermostat Dimensions.....	49
Specifications.....	49

12.0 Installer Notes

1.1 Box Contents

- AWRT10RF Wireless Radiant Thermostat with backplate
- (2) AA Alkaline Batteries (installed)
- (2) Mounting Screws
- (2) Plastic Wall Anchors
- Quick Start Guide



1.2 Using this Manual

For the latest instructions go to: www.salusinc.com

Special Attention Boxes

This manual uses special attention icons to alert the reader of important safety concerns, information important to reliable operation of the controls or helpful installation/setup information



Safety:

Indicates a condition which may cause severe personal injury, death or major property damage



Important Information:

Indicates information which requires special attention for correct operation of the control



Your Benefit:

Indicates helpful installation or setup information

1.3 Product Safety Information



Codes & Regulations: Installation and setup of this product must be performed in strict compliance with country, state/province and local regulating agencies and codes that deal with Class B digital devices. In the absence of local requirements, the FCC rules, listed below, are to be followed.



Intended Use: The SALUS AWRT10RF Wireless Thermostat is intended for interior room temperature control in conjunction with hydronic heating systems only. Other uses are not recommended or supported.



Installer or Contractor: Record any parameter changes in Section 12, Installer Notes.

1.4 SALUS Smart Home Application

Use SALUS Smart Home to:

- Quickly view and monitor the status of your home and smart devices
- Set schedules and preferences for your connected thermostats, smart plugs and more
- Receive important real-time alerts and notifications of any changes that occur with your system

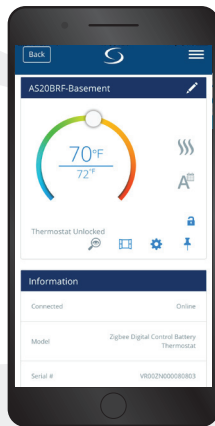
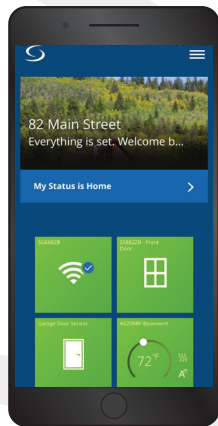
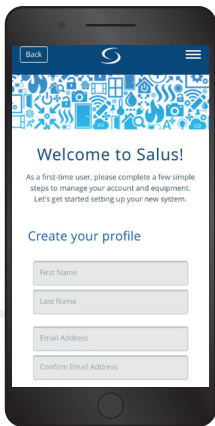

Apple, the Apple logo, iPhone, and iPod touch are trademarks of Apple Inc, registered in the U.S. and other countries. App Store is a service mark of Apple Inc, registered in the U.S. and other countries

Google Play and the Google Play logo are trademarks of Google LLC.

Download the SALUS Smart Home application on your IOS or Android device for remote access to your home comfort system. For security purposes you will be prompted to set up a user profile including username & password.

1.5 SALUS Wireless System Constraints

- A maximum of 9 AKL Series Relay Controllers can be connected to each SALUS Wireless System
- A maximum of 6 ARV10RFM or AVA10M30RF can be connected to each AWRT10RF Thermostat
- Only 1 AX10RF (RX1) and 1 AX10RF (RX2) can be connected to each SALUS Wireless System

2.1 Installation *with Internet Connection*

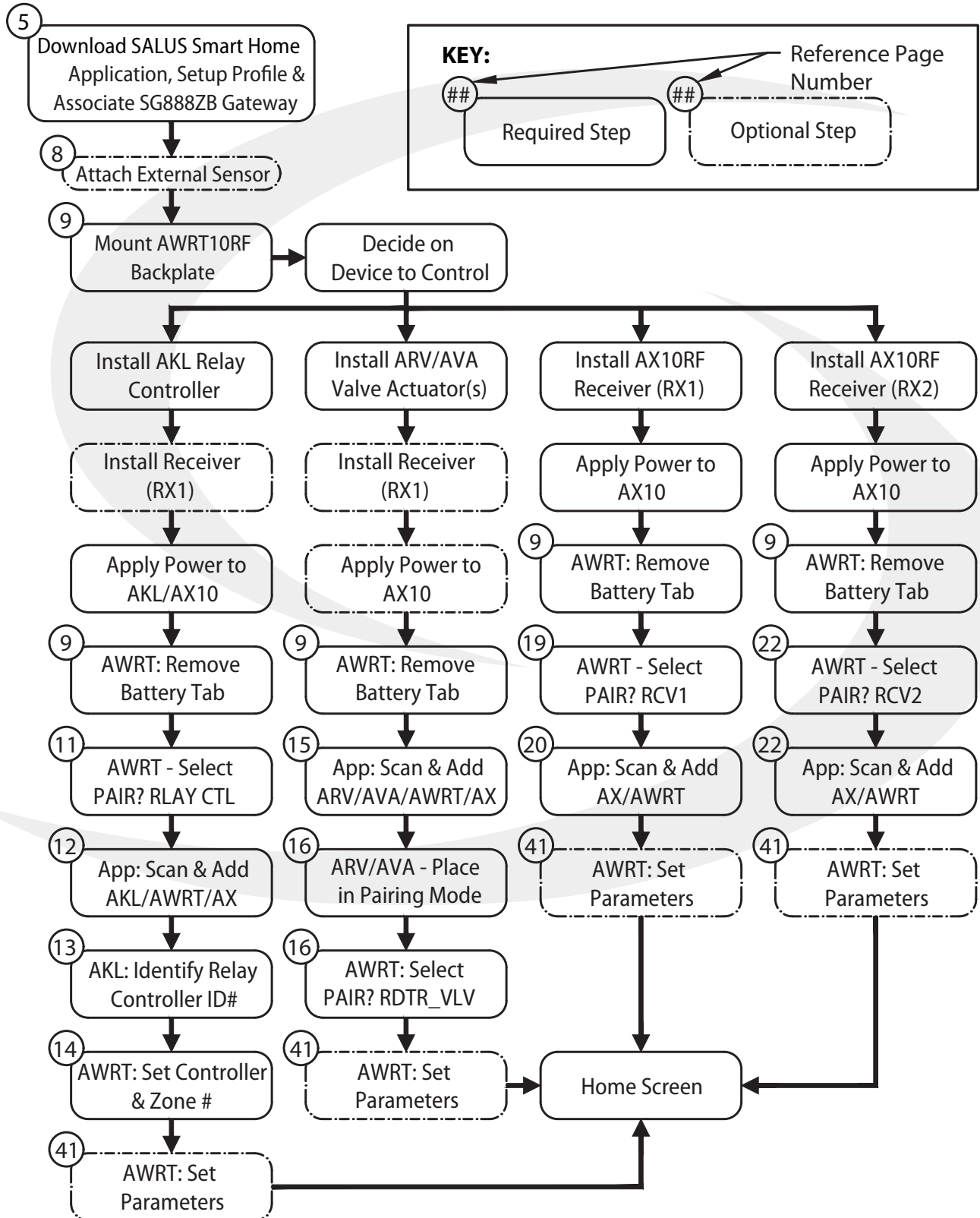

2.2 Installation *without Internet Connection*

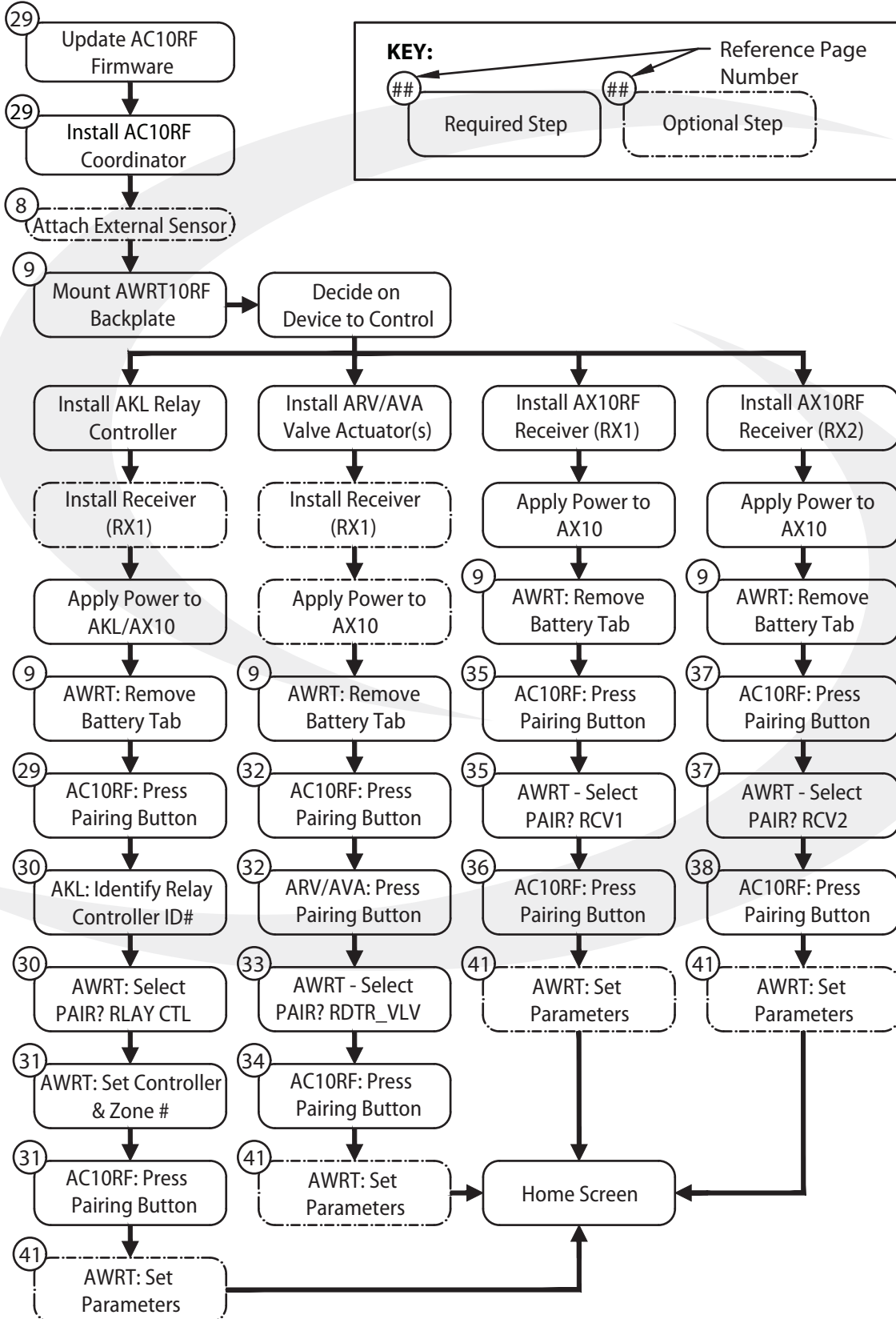

Mounting and Optional Temperature Sensor Wiring

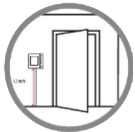

SALUS components must be set up for wireless communication with the SG888ZB Gateway or with the AC10RF Coordinator. This process, called “pairing”, should be performed with all devices installed in their intended location. If the intended operating location is unsuitable for the pairing process for convenience or other factors, the device may be located in a convenient location during pairing.

DO NOT Mount the AS20 Thermostat near any heat source, behind curtains, in direct sunlight, in areas of high humidity or area where water is present.

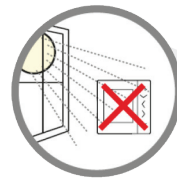
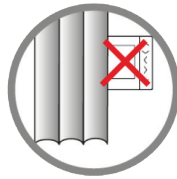

Avoid mounting the AWRT10RF Thermostat on an exterior wall.

Step 1. Ensure that all required parts were included in the package.

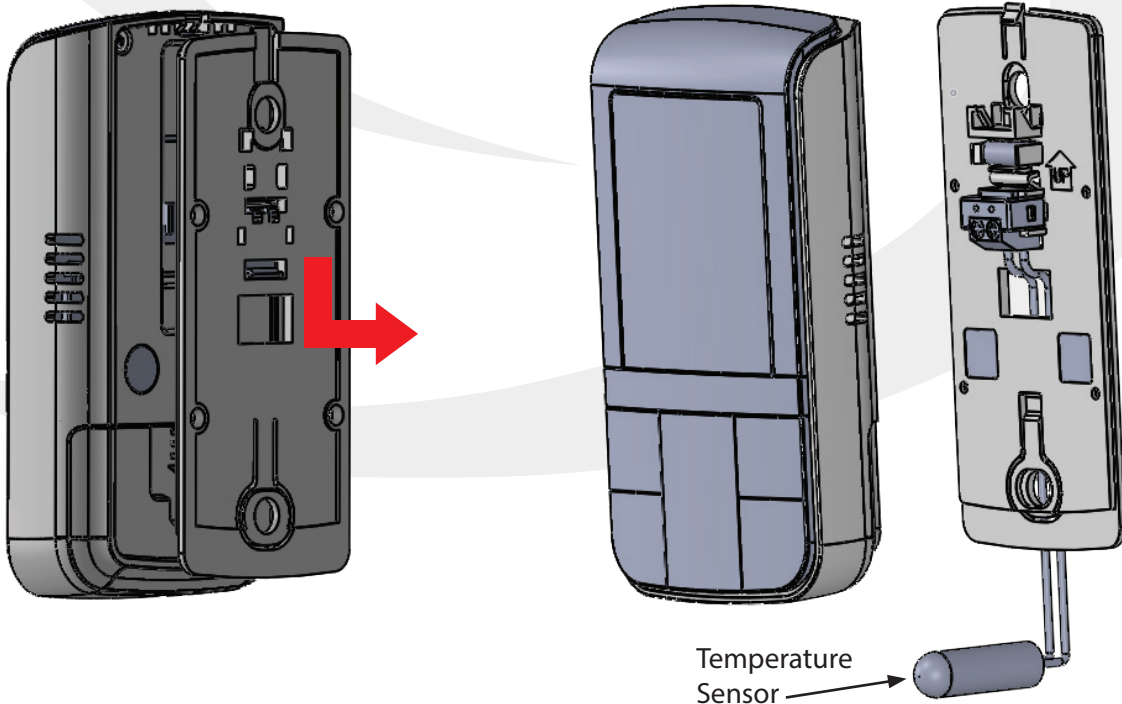

Step 2. Remove the AWRT10RF Thermostat from the backplate by lifting the tab in the top center and sliding the base downward.

Step 3. Connect an external 10 kΩ NTC sensor (AFTS30M sold separately), if desired, to the sensor terminals on the backplate.

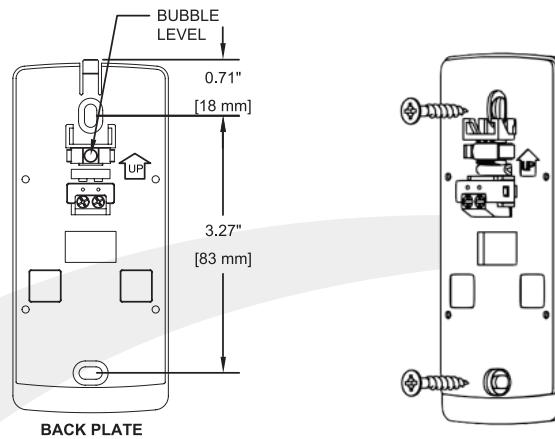

Step 4. Secure the backplate to the wall using the provide screws and wall anchors



FOR BEST RESULTS, ensure that the AWRT10RF Thermostat backplate is level, using the integral bubble level, when mounting it. **NOTE THE ORIENTATION ARROW** molded into the backplate indicating correct orientation.

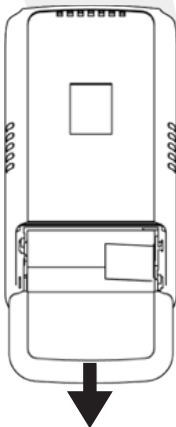

Step 5. Open the battery compartment



Step 6. Remove the battery tab to power the AWRT10RF Thermostat

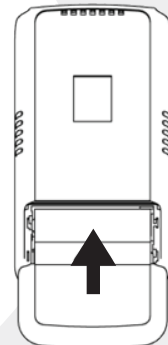

Step 7. Close the battery compartment

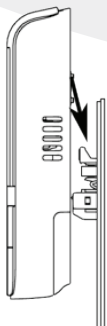

Step 8. Attach the AWRT Thermostat by positioning it against the backplate and sliding downward.



The AWRT Thermostat can be removed by gently pushing the latch at the top of the thermostat and sliding the thermostat upward.

4.1 Home Screen and Key Functions

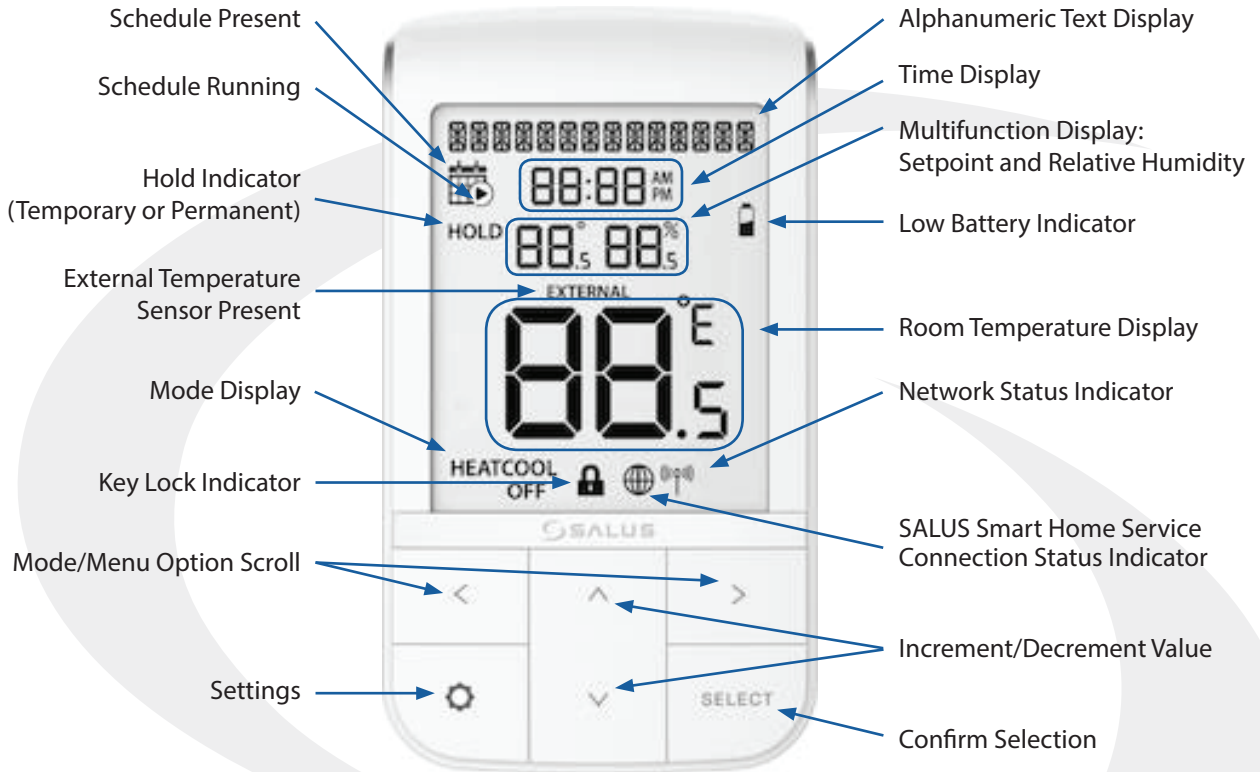

4.2 Display Screen Boot Sequence



Displays boot loader version number for 3 seconds

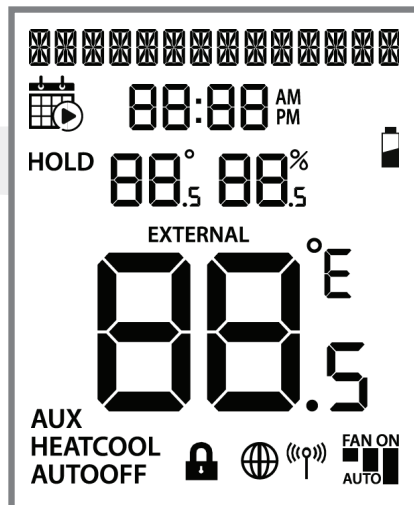

Displays all available LCD segments for 3 seconds

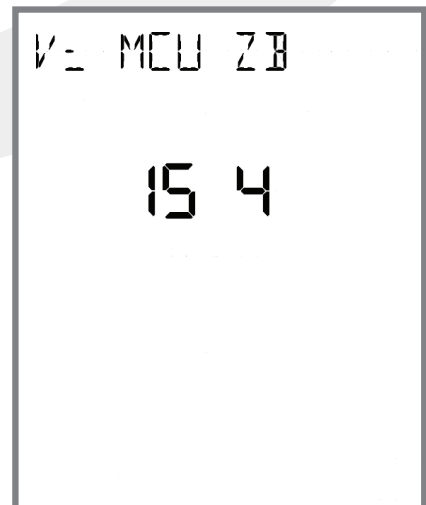

Displays MCU firmware and Zigbee code for 3 seconds

After the boot up sequence on the initial power up, the AWRT10RF immediately enters the pairing process. Use the \wedge and \vee keys to select between the following devices:

DEVICE	MODEL(S)	DISPLAY
Relay Controller	AKL01PRF	PAIR? RLAY_CTL
	AKL04PRF	
	AKL06PRF	
	AKL08RF	
Radiator Valve	ARV10RFM-3	PAIR? RTRVLV
	AVA10M30RF	
Receiver (RX1)	AX10RF (RX1)	PAIR? RCV1
Receiver (RX2)	AX10RF (RX2)	PAIR? RCV2



To connect the AWRT Wireless Radiant Thermostat and other components using an SG888ZB Gateway, the gateway must be installed and activated. Please see the [SALUS SG888ZB Installation Instructions \(https://www.salusinc.com/wp-content/uploads/2017/10/BZG_IUG-ENv4.pdf\)](https://www.salusinc.com/wp-content/uploads/2017/10/BZG_IUG-ENv4.pdf) for information about setting up the gateway.

5.1 – Pairing with AKL01/04/06PRF and AKL08RF Relay Controllers

Before pairing, the AKL Series Relay Controller and optional AX10RF Receiver (if desired) must be installed and powered in accordance with installation instructions included with these devices.

- The LED ring on the SG888ZB Gateway should be solid blue
- The Network Status LED on the AKL Relay Controller should be flashing
- If an AX10RF Receiver is used, the LED backlight on the Auto/Manual switch of this device should be flashing red and the switch should be in the Auto position



Step 1. If PAIR? RLAY_CTL is not displayed and flashing, use the \wedge or \vee keys to display it. Press the SELECT key on the AWRT10RF Thermostat.



The display will show JOINING--- with a 10 minute countdown timer to show how much time is available to complete the next steps. The icon will flash at the bottom of the screen indicating that the thermostat is searching for a network to join.

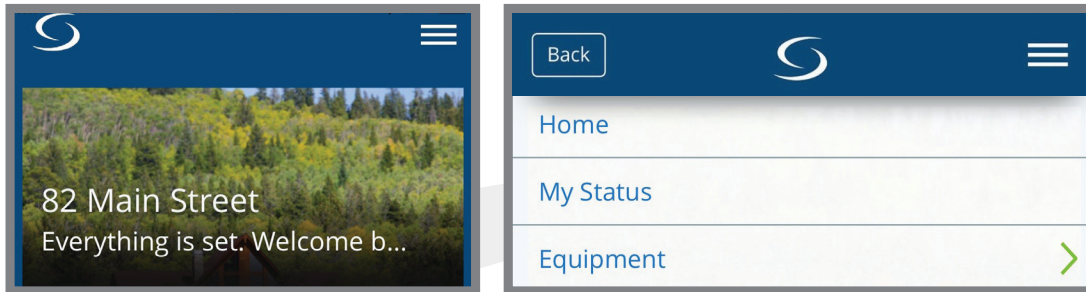

Step 2. Open the SALUS Smart Home application, select the drop down menu from the upper right of the screen and select:

Equipment → Add New Equipment → Scan for Equipment

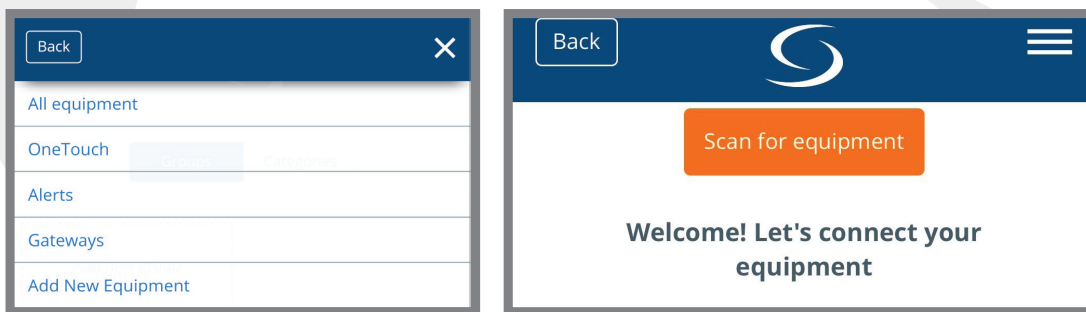

Step 3. Click the “Scan for equipment” button. The SG888ZB Gateway’s LED will flash red as it searches for devices.

When the components are joined to the network

- The Network Status Indicator on the AWRT10RF Thermostat will turn steady on,
- The Network Status LED on the AKL Series Relay Controller will turn steady on, and
- If present, the red LED backlight on the Auto/Manual switch of the AX10RF Receiver will turn steady on

Section 5.0

Pairing with Wireless Devices Using SG888ZB Gateway (w/ Internet Connection)

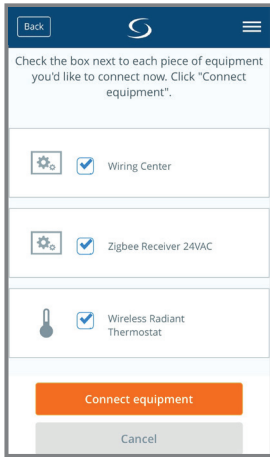

Step 4. Select the check boxes for both the Wiring Center (Relay Controller) and the Zigbee Receiver on the SALUS Smart Home application. Then press the “Connect equipment” button. The SG888ZB Gateway LED ring will return to steady blue.

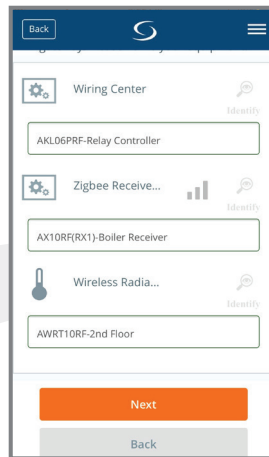

Step 5. Give each device a descriptive name that allows easy identification. If there are multiple relay controllers, identify each with respect to its location and/or purpose.

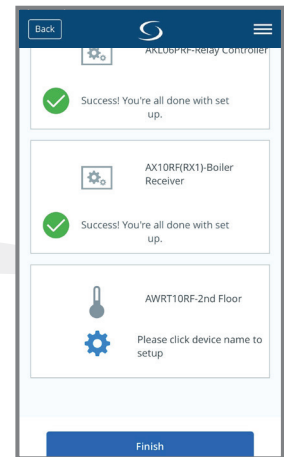

Step 6. Press “Finish” to save the device information.



Pressing the  icon on the AWRT10RF Thermostat prior to pressing Finish on the SALUS Smart Home application starts the thermostat parameter setup. As covered in Section 8 of this manual, this can be setup after completing the pairing process.

AKL Relay Controller ID

ID #	Zone 1	Zone 2	Zone 3	Zone 4
1	●			
2		●		
3			●	
4				●
5	●			●
6		●		●
7			●	●
8	●		●	●
9		●	●	●
0	●	●	●	●

AKL01 Relay Controller ID#
Zone LED Pulse Code

ID #	LED Pattern Short = ●, Long = ■
1	●
2	● ●
3	■
4	■ ●
5	■ ● ●
6	■ ■
7	■ ■ ●
8	■ ■ ■ ●
9	■ ■ ■ ■

AKL01/04/06PRF Relay Controller Pairing Button



AKL08RF Relay Controller Pairing Button

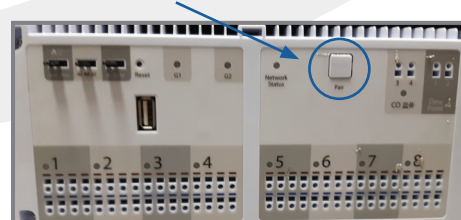

Step 7. Once the AKL Relay Controller is connected (network status LED is no longer flashing), briefly press the pairing button (shown above) on the relay controller. Zone LEDs on the AKL Relay Controller will illuminate indicating the ID number of the AKL device. This number will be used to set up thermostats to address the correct relay controller.



- When zone LEDs are illuminated in ID mode, the illuminated zone outputs will be activated.
- The AKL01PRF Relay Controller uses the pulse codes shown above to identify the ID number. A short pulse = 1 and a long pulse = 3. Add the pulse values of all pulses for the ID of the relay controller.

Section 5.0

Pairing with Wireless Devices Using SG888ZB Gateway (w/ Internet Connection)



Once the AWRT10RF Thermostat has joined the network, SCANNING--- is displayed with a 10-minute countdown timer showing the time allowed to find all the relay controllers on the network



When the AWRT10RF Thermostat has found all controllers in the network, it will display the default relay controller value (1) and the default zone value (1). If there is more than 1 relay controller on the network, the left value CNTRLR will flash. If there is only one relay controller, the right-hand value for ZONE will flash.



Step 8. Use the \wedge and \vee keys to change the CONTROLLER value, then the \lt or \gt key to switch to the ZONE.



Step 9. Use the \wedge and \vee keys to change the ZONE value, then press SELECT. The AWRT10RF Thermostat will then display PAIRING--- as it associates with the selected controller and zone.



When paired, RLY_CTL PAIRED will be displayed briefly along with the CNTRLR value and ZONE value.



The AWRT10RF Thermostat will enter parameter setup mode, starting with parameter P 01. The current device type along with the Zigbee channel number will be displayed.

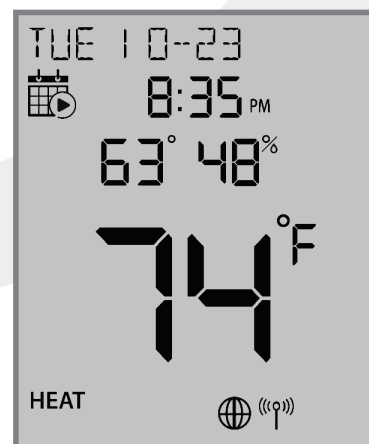

Step 10. Press the \odot key to exit parameter setup and go to the Home Screen. The display shows the current date & time, target temperature, relative humidity, network/internet status and room temperature.

5.2 – Pairing with ARV10RFM or AVA10M30RF Radiator Valve Actuators

Before beginning, it is important that the ARV/AVA Radiator Valve Actuator is installed and adapted properly as detailed in the installation instructions. The following is a review of those instructions.

ARV/AVA Radiator Valve Actuator Installation Review

Step 1. Install the batteries and wait until the LED is solid red before installing the actuator on the radiator valve. Remember that the knurled nut on the actuator should only be finger tight. Using pliers or other tools can damage the device.

Step 2. After attaching the actuator to the valve, press any of the buttons to initialize the ARV10RFM or AVA10M30RF Radiator Valve Actuator. This process may take several minutes, and the valve may continue to initialize after the light is no longer illuminated.



DO NOT BEGIN pairing with the ARV/AVA Radiator Valve Actuator unless the light is out and there is no motor activity. Listen closely to the Valve Actuator to be sure it is not operating before proceeding.

ARV/AVA Radiator Valve Actuator Pairing Procedure

Before pairing, the radiator valve actuators and optional AX10RF Receiver (if desired) must be installed and powered in accordance with the installation instructions include with the devices.

- The LED ring on the SG888ZB Gateway should be solid blue
- The LED on the ARV/AVA Valve Actuator(s) should be off with NO MOTOR ACTIVITY,
- If an AX10RF Receiver is used, the LED backlight on the Auto/Manual switch of this device should be flashing red with the switch in the Auto position.

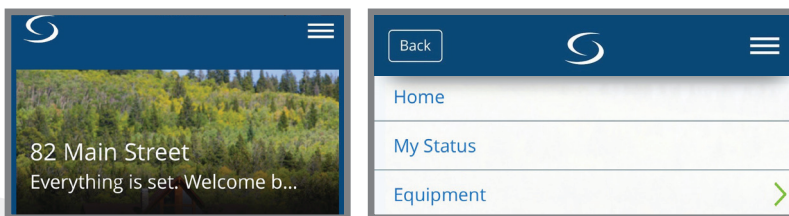

Step 1. Open the SALUS Smart Home mobile application and select the drop down menu from the upper right side of the screen select:

Equipment → Add New Equipment → Scan for Equipment

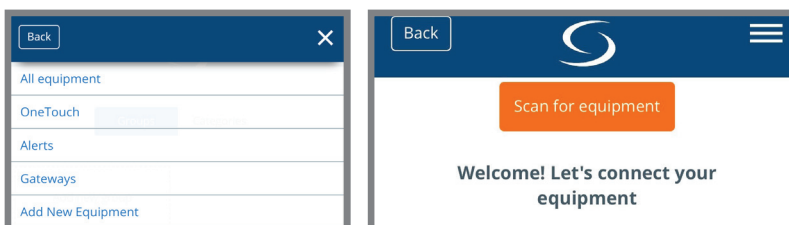

Step 2. Click the “Scan for equipment” button. The SG888ZB Basic Gateway’s LED will flash red as it searches for devices.



Section 5.0

Pairing with Wireless Devices Using SG888ZB Gateway (w/ Internet Connection)

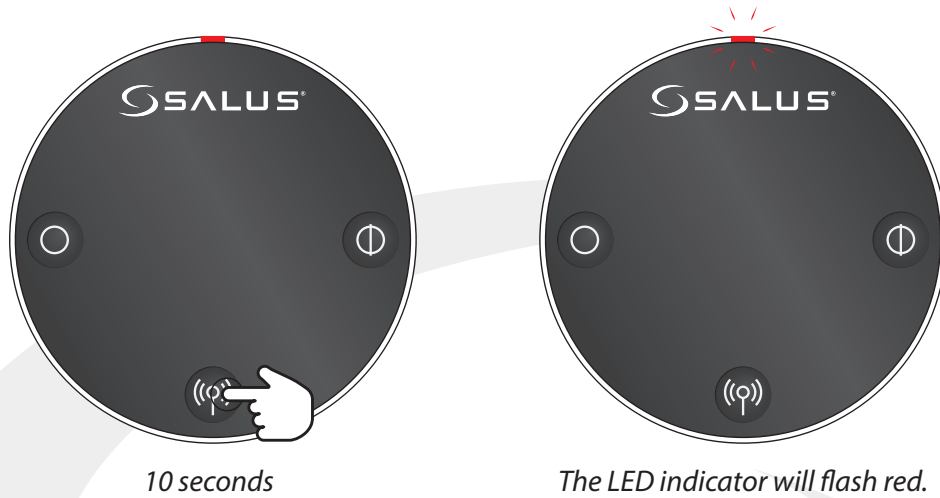

Step 3. Press and hold the pair button for 10 seconds to enter pairing mode on each actuator to be connected.



Step 4. Use the \wedge and \vee keys on the AWRT10RF Thermostat to switch from RLAY_CTL to RDTR_VLV. Press SELECT to initiate pairing.



JOINING- - - is displayed with a 10 minute countdown timer to show the remaining time available to complete the next steps. The $\text{((\text{P}))}$ icon will flash at the bottom of the screen indicating that the thermostat is searching for a network to join.



Once the AWRT10RF Thermostat joins a network, the $\text{((\text{P}))}$ icon will stop flashing and the network channel will be briefly displayed. After that, PAIRING- - - is displayed with a countdown timer showing the time allowed for the remaining pairing steps.

Section 5.0

Pairing with Wireless Devices Using SG888ZB Gateway (w/ Internet Connection)



If there are any valve actuators already on the network, they will be paired with the AWRT10RF.

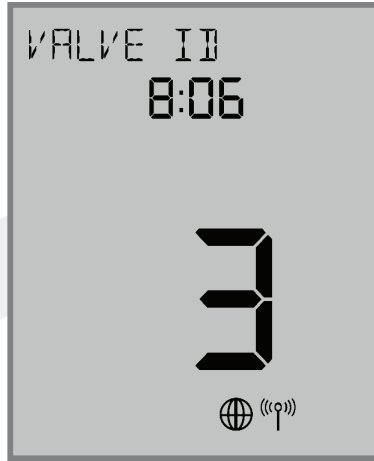

As each ARV/AVA Valve Actuator joins the network, it is paired with the AWRT Thermostat and the valve ID number displayed on the screen will increment. Once paired, the LED on the valve actuator will turn off.



If the user presses the  key, the timer times out or 6 valves have been paired, the display will show the total number of valves paired for 3 seconds before going to the parameter setup mode.



In parameter setup mode, the AWRT10RF Thermostat starts with P 01 (displayed with RDTR_VLV flashing)

LED is solid red.

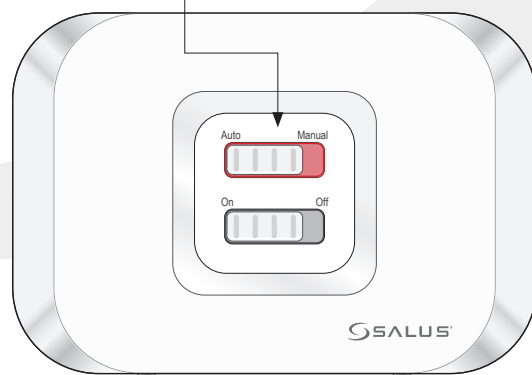

If an AX10RF Receiver configured as RX1 has joined the network, it will automatically be paired with the AWRT and the LED backlight on the Auto/Manual switch will stay solid red.

Section 5.0

Pairing with Wireless Devices Using SG888ZB Gateway (w/ Internet Connection)

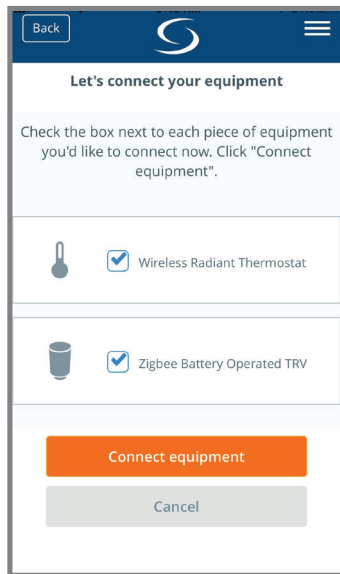

Step 5. Select “Wireless Radiant Thermostat” and “Zigbee Battery Operated TRV”, checking the boxes. Press “Connect equipment”. The LED ring on the SG888ZB Gateway will return to a steady blue.

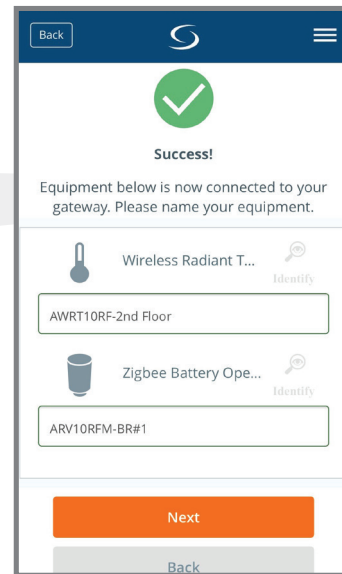

Step 6. Give the AWRT10RF Thermostat and each ARV/AVA Actuator a descriptive name, differentiating it from others in the network. Press “Next”. If the AWRT is in parameter setup mode when the “Next” button is pressed, it will go to the Home screen.

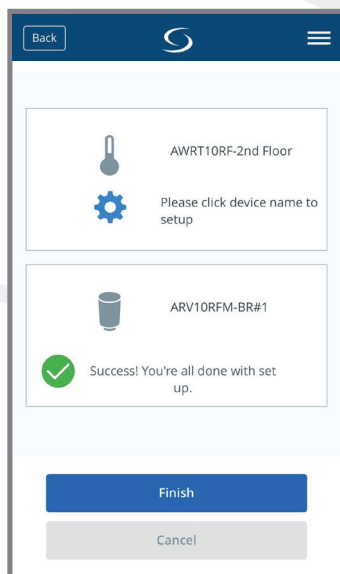

Step 7. Press “Finish” to complete the connection to the SALUS Smart Home application.

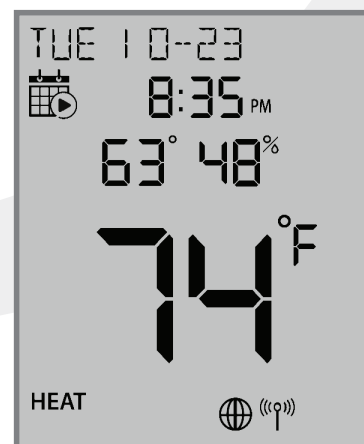

Step 8. Press the  key to exit parameter setup and go to the Home Screen. The display shows the current date & time, target temperature, relative humidity, network/internet status and room temperature.

5.3 – Pairing with AX10RF Receiver for Boiler Switching (RX1)



- This pairing procedure is only used when direct control of an AX10RF Receiver by the AWRT10RF Thermostat is desired.
- Each system will support only one AX10RF configured as RX1 and one configured as RX2.



This configuration is typical in boiler systems in which there is only one thermostat in the system such as a single steam heating loop or single forced circulation, hot water loop. For systems with multiple zones, a zone relay controller such as the SALUS AKL Series is recommended.

Before starting the pairing process, be sure that the AX10RF Receiver is installed as shown in the installation instructions included with the device.

- The switch on the inside cover must be configured to RX1
- The LED backlight on the Auto/Manual switch of the AX10RF Receiver should be flashing red
- The Auto/Manual switch of the AX10RF Receiver should be in the AUTO position
- The SG888ZB Gateway must be powered with solid blue LED indication that it is connected to the internet
- The AWRT10RF Thermostat should be powered up and flashing PAIR? RELAY_CTL



Step 1. On the AWRT10RF Thermostat, press \wedge until PAIR? RCV1 is displayed. Press SELECT.

JOINING- - - will be displayed with a 10 minute countdown timer and a flashing network status indicator.

Section 5.0

Pairing with Wireless Devices Using SG888ZB Gateway (w/ Internet Connection)

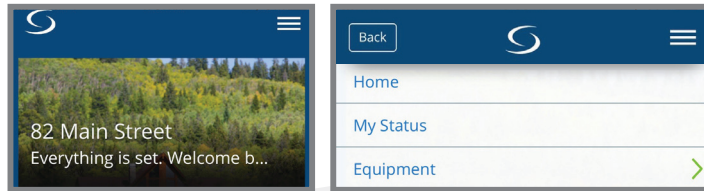

Step 2. Open the SALUS Smart Home mobile application and select the drop-down menu from the upper right side of the screen:

Equipment → Add New Equipment → Scan for Equipment

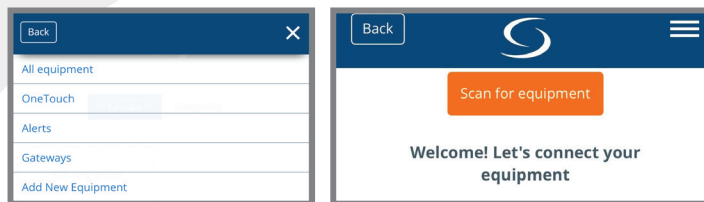

Step 3. Click the “Scan for equipment” button. The SG888ZB Gateway will flash red as it searches for devices.

When the AX10RF Receiver joins the network, the red LED backlight on the Auto/Manual Switch will turn steady on.

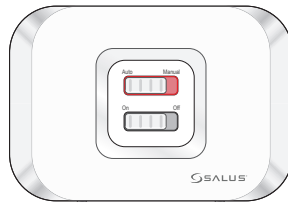

Once the AWRT10RF Thermostat joins a network, the  icon will stop flashing and the network channel will be displayed briefly. The home screen will show PAIRING- - - with a 10-Minute countdown timer as the AWRT10RF Thermostat looks for an RX1 device.



After pairing is complete, a confirmation screen is displayed on the AWRT10RF Thermostat for 3 seconds, then the device will enter the parameter setup mode.



The thermostat display will show “PAIR: RCV1” with P 01 indicating it is in the parameter setup mode. “Cn” (Connected) indicates that the AX10RF Receiver is paired and connected.

Section 5.0

Pairing with Wireless Devices Using SG888ZB Gateway (w/ Internet Connection)

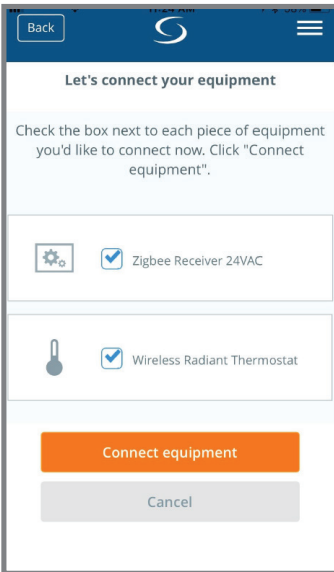

Step 4. On the SALUS Smart Home application, check the boxes for both the AWRT10RF Thermostat and the AX10RF Receiver. Press "Connect equipment".

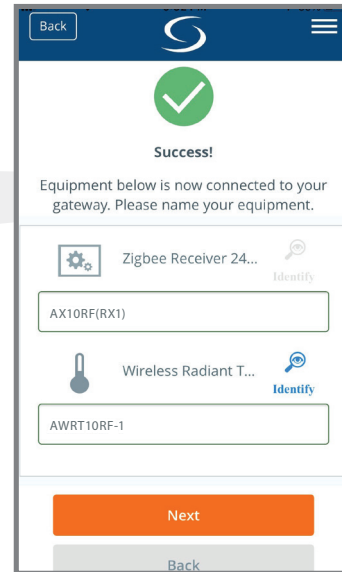

Step 5. Enter a descriptive name for each device. Press "Next" to continue. Since the receiver is already paired, when the AWRT10RF Thermostat is renamed it will immediately go to the home screen, ending parameter setup.

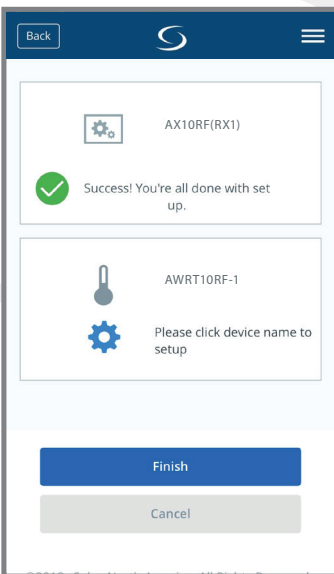

Step 6. After naming the devices, the application will show that set up is complete. Press Finish to finalize the application setup.

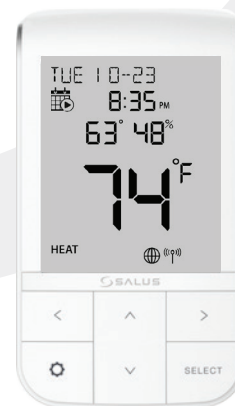

If you do not rename the AWRT10RF Thermostat in the SALUS Smart Home application, the device may stay in parameter setup mode. Press the  key to exit setup.

5.4 – Pairing with AX10RF Receiver for Zone Valve Switching (RX2)



- This pairing procedure is only used when direct control of an AX10RF Receiver by the AWRT10RF Thermostat is desired.
- Each system will support only one AX10RF configured as RX1 and one configured as RX2. These two configurations can be used together to provide boiler switching and zone valve operation.

Before starting the pairing process, be sure that the AX10RF Receiver is installed as shown in the installation instructions included with the device.

- The switch on the inside cover must be configured to RX2
- The LED backlight on the Auto/Manual switch of the AX10RF Receiver should be flashing red
- The Auto/Manual Switch of the AX10RF Receiver should be in the AUTO position
- The SG888ZB Gateway must be powered with solid blue LED indication that it is connected to the internet
- The AWRT10RF Thermostat should be powered up and flashing PAIR? RELAY_CTL



Step 1. On the AWRT10RF Thermostat, press ^ until PAIR? RCV2 is displayed. Press SELECT.

JOINING- - - will be displayed with a 10 minute countdown timer and a flashing network status indicator.

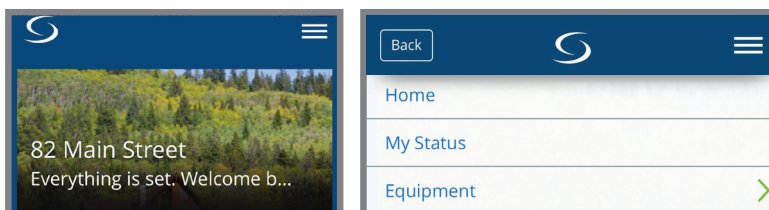

Step 2. Open the SALUS Smart Home mobile application and select the drop-down menu from the upper right side of the screen:

Equipment → Add New Equipment → Scan for Equipment

Section 5.0

Pairing with Wireless Devices Using SG888ZB Gateway (w/ Internet Connection)

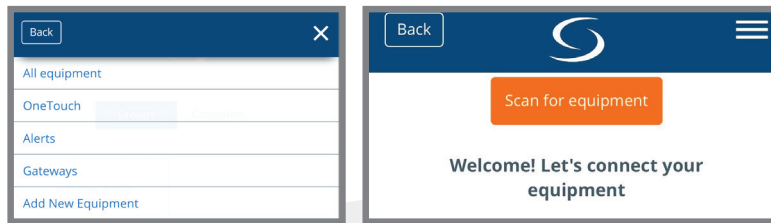

Step 3. Click the “Scan for equipment” button. The SG888ZB Gateway will flash red as it searches for devices.

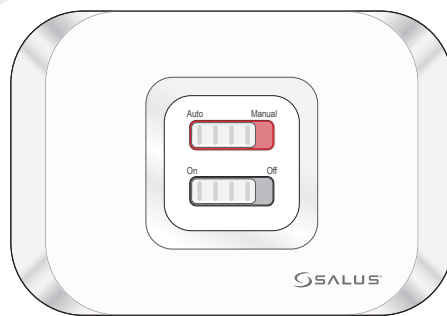

When the AX10RF Receiver joins the network, the red LED backlight on the Auto/Manual Switch will turn steady on.



Once the AWRT10RF Thermostat joins a network, the  icon will stop flashing and the network channel will be displayed briefly. The home screen will show PAIRING- - - with a 10-Minute countdown timer as the AWRT10RF Thermostat looks for an RX2 device.



After pairing is complete, a confirmation screen is displayed on the AWRT10RF Thermostat for 3 seconds, then the device will enter the parameter setup mode.



The thermostat display will show PAIR: RCV2 with P 01 indicating it is in the parameter setup mode. Cn (Connected) indicates that the AX10RF Receiver is paired and connected.

Section 5.0

Pairing with Wireless Devices Using SG888ZB Gateway (w/ Internet Connection)

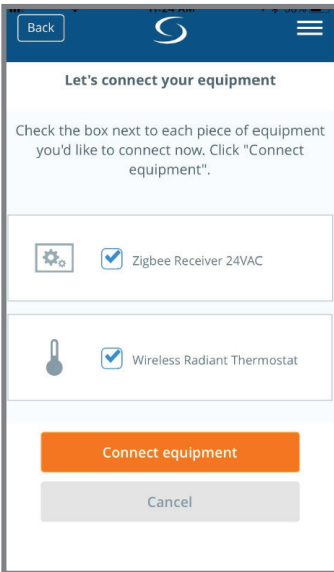

Step 4. On the SALUS Smart Home application, check the boxes for both the AWRT10RF Thermostat and the AX10RF Receiver. Press "Connect equipment".

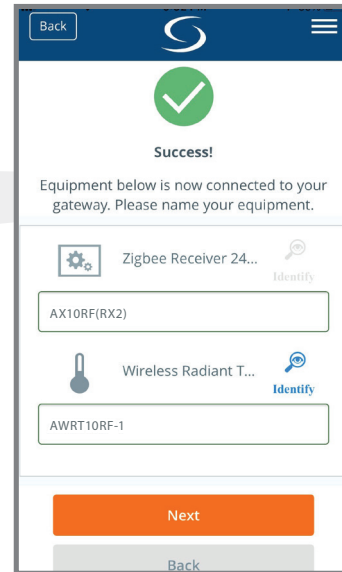

Step 5. Enter a descriptive name for each device. Press "Next" to continue. Since the receiver is already paired, when the AWRT10RF Thermostat is renamed it will immediately go to the home screen, ending parameter setup.

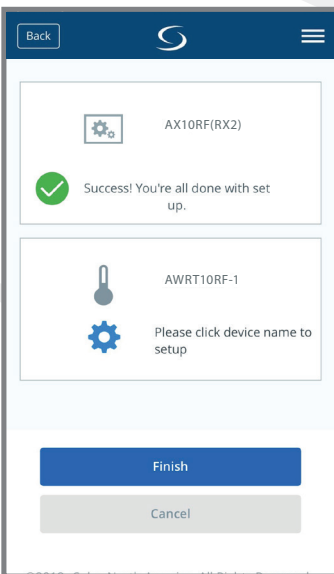

Step 6. After naming the devices, the application will show that set up is complete. Press Finish to finalize the application setup.

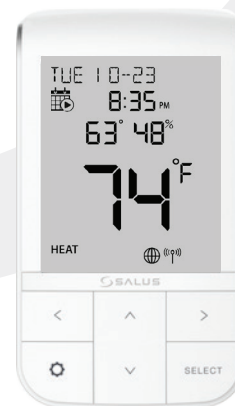

If you do not rename the AWRT10RF Thermostat in the SALUS Smart Home application, the device may stay in parameter setup mode. Press the  key to exit setup.

SALUS Smart Home Application: The following illustrates the dashboard and control panel for the Wireless Radiant Thermostat in the SALUS Smart Home Application on a mobile device or computer.

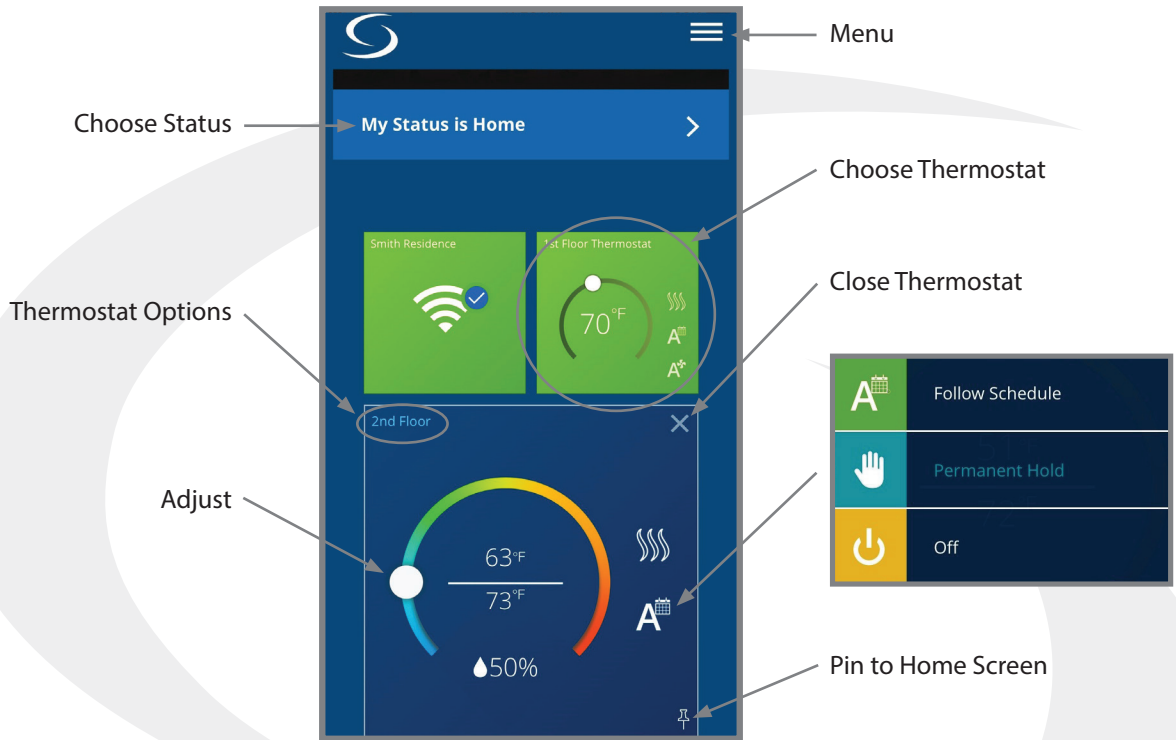

Thermostat Options: Press Thermostat Options to advance to the screen below.

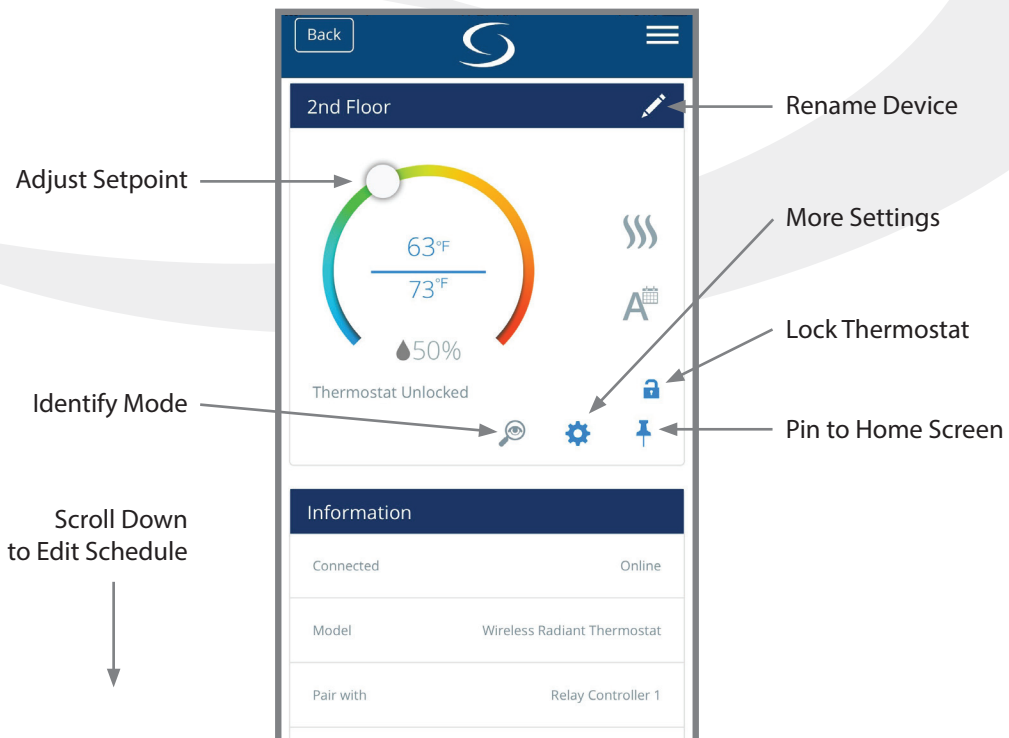

6.1 – Parameter Settings

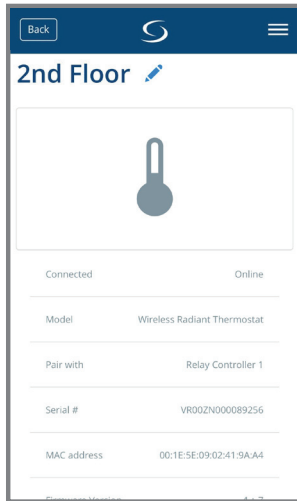

Step 1. Choose the gear icon to access parameter settings. Scroll down to see the available settings.

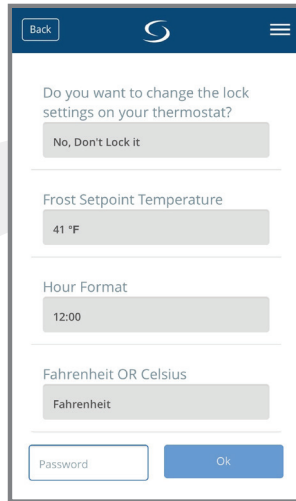

Step 2. Parameters listed can be changed without a password. Enter "49" in the password field and press "Ok" to access advanced options.

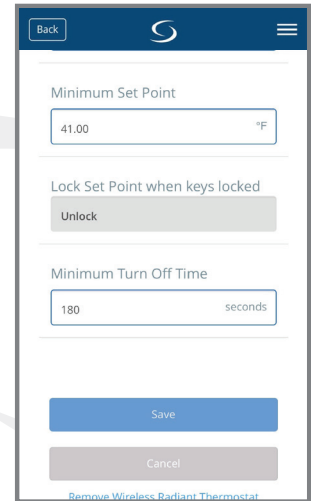

Step 3. After making parameter adjustments, press the "Save" button

6.2 – Schedule Setup

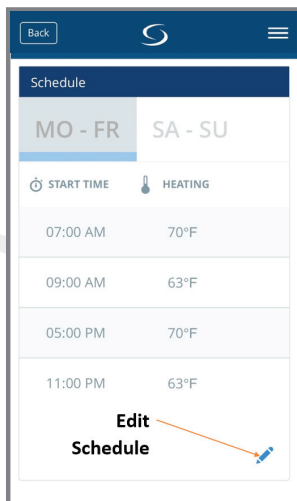

Step 1. Scroll down on the Thermostat options menu to see default schedule. Choose the edit icon at the bottom to customize the schedule.

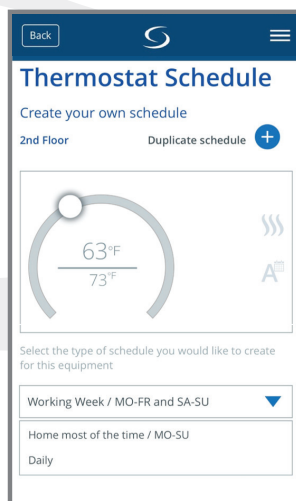

Step 2. Choose from the 3 schedule types on the drop-down menu and scroll down to edit the schedule.

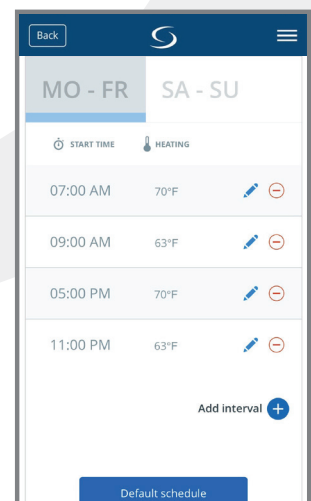

Step 3. Select the pencil icon to adjust the start time or temperature for any interval. To add an interval, use the "Add interval" icon.



6.3 – Remote Operation

The following instructions describe operation of the AWRT10RF Thermostat using the SALUS Smart Home Application to make adjustments from any location.

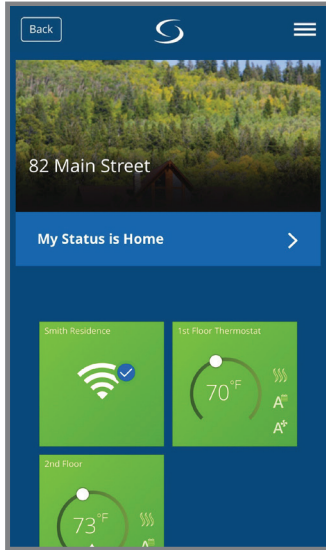

To make changes to the thermostat settings using the SALUS Smart Home Application, simply choose the icon from the home screen.

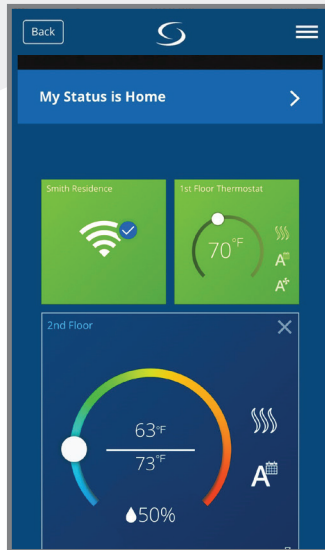

To change the current temperature setpoint, move the dial to the desired temperature.

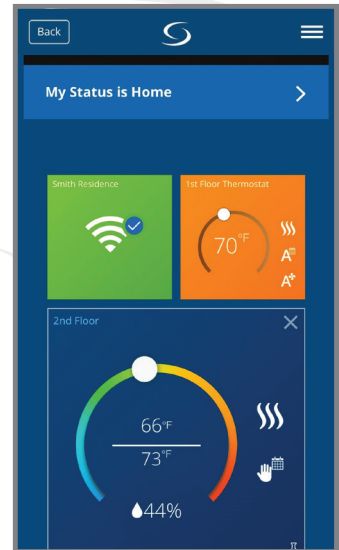

The  icon indicates a temporary temperature hold that will end when the next scheduled period begins.

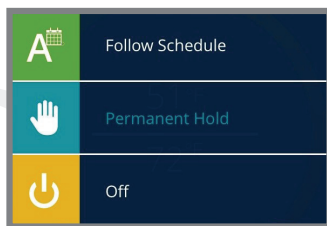

Selecting the  icon will display the menu shown providing 3 options.

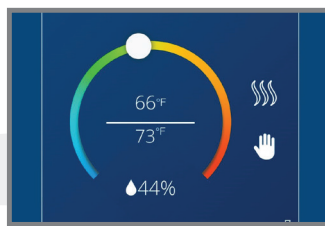

Pressing "Permanent Hold" will display the icon shown above and will keep the setpoint at the current temperature, ignoring schedule changes.

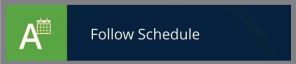

Pressing "Off" will cause the AWRT10RF Thermostat to stop calling for heat until it is turned back on.

Pressing  will have the AWRT10RF Thermostat go back to the programmed schedule, starting at the current day and time.

The following instructions describe identification and/or disabling of ARV/AVA Radiator Valve Actuators. It is not recommended to disable or enable radiator valve actuators without visual access to the devices.

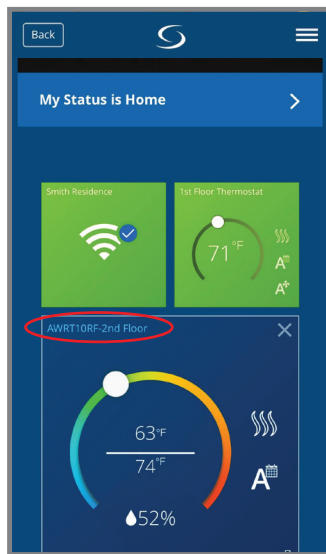

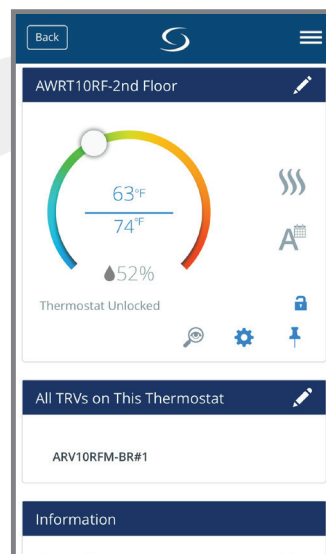

Choose the thermostat that controls the Radiator Valve Actuators. Then select the thermostat name (circled in red).

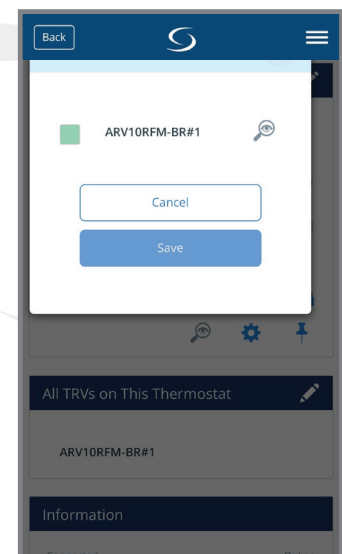

The setting screen will show all thermostatic radiator valves (TRVs) associated with the AWRT10RF Thermostat.



Choosing the  symbol displays the list of TRVs. Choosing the  icon will cause the LED indicator on the associated ARV10RFM or AVA10M30RF Radiator Valve Actuator to flash green, identifying the valve.

To disable an ARV/AVA Radiator Valve Actuator, select the green box, which will remove the green indication, and press "Save". To enable an ARV/AVA Radiator Valve Actuator, select the gray indicator box, which will turn the indicator green, and press "Save".

System Configuration without internet connection

Prior to using the AC10RF Coordinator on a system with no internet connection, update the firmware version as follows:

1. Use a computer with an internet connection that meets the following requirements:

COMPUTER	PC	Mac
OPERATING SYSTEM	Windows 8 or later	OSX 10.10 or later
USB PORT	Type A	Type A

2. Go to the SALUS Software Tools web page: www.salusinc.com/tools.html
3. Download and run the Coordinator Update Tool to update the AC10RF Coordinator by following the onscreen instructions.
4. Insert the AC10RF Coordinator into a USB port on the computer when prompted to do so

After updating the firmware, insert the AC10RF Coordinator into the provided power adapter and plug the two devices into an AC outlet. Verify that the LED is solid red.

7.1 – Pairing with AKL01/04/06PRF and AKL08RF Relay Controllers

Before pairing, the AKL Series Relay Controller and optional AX10RF Receiver (if desired) must be installed and powered in accordance with installation instructions included with these devices.

- The Network Status LED on the AKL Relay controller should be flashing and,
- if an AX10RF Receiver is used, the LED backlight on the Auto/Manual switch of this device should be flashing red.



Step 1. Press and hold the lighted red button on the AC10RF Coordinator for 5 seconds until the LED begins flashing, to begin pairing. When the network status LED on the AKL Relay Controller and the backlight on the Auto/Manual switch of the AX10RF (if used) stop flashing, they have joined the network and you are ready to pair the AWRT Wireless Radiant Thermostat.



If the network status LED on the AKL Relay Controller continues blinking, turn off the power to the device for 10 seconds.

Section 7.0

Pairing with Wireless Devices using AC10RF Coordinator (w/o Internet Connection)

AKL Relay Controller ID

ID #	Zone 1	Zone 2	Zone 3	Zone 4
1	●			
2		●		
3			●	
4				●
5	●			●
6		●		●
7			●	●
8	●		●	●
9		●	●	●
0	●	●	●	●

AKL01 Relay Controller ID# Zone LED Pulse Code

ID #	LED Pattern Short = ●, Long = ▬
1	●
2	● ●
3	▬
4	▬ ●
5	▬ ● ●
6	▬ ▬
7	▬ ▬ ●
8	▬ ▬ ● ●
9	▬ ▬ ▬

AKL01/04/06PRF Relay Controller Pairing Button



AKL08RF Relay Controller Pairing Button

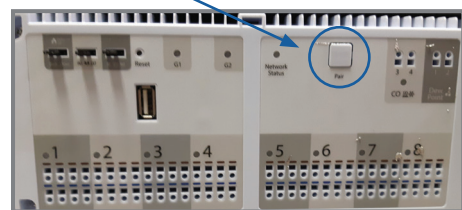

Step 2. Once the AKL Relay Controller is connected (network status LED is no longer flashing), briefly press the pairing button (shown above) on the relay controller. Zone LEDs on the AKL Relay controller will illuminate indicating the ID number of the device. This number will be used to set up thermostats to address the correct relay controller.



- When zone LEDs are illuminated in ID mode, the illuminated zone outputs will be activated.
- The AKL01PRF Relay Controller uses the pulse codes shown above to identify the ID number. A short pulse = 1 and a long pulse = 3. Add the pulse values of all pulses for the ID of the relay controller.

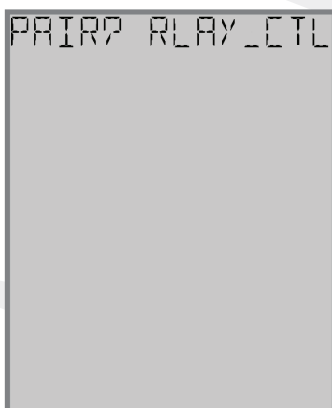

Step 3. After the AWRT10RF Thermostat completes its boot sequence, the Relay Controller (RLAY_CTL) will be displayed and flashing. If another device is displayed, use the ^ or v keys to display the correct device. Press SELECT to start the pairing process.

The display will show JOINING- - - with a 10 minute countdown timer to show how much time is available to join a network. The (()) icon will flash at the bottom of the screen indicating that the thermostat is searching for a network to join.

Section 7.0

Pairing with Wireless Devices using AC10RF Coordinator (w/o Internet Connection)



Once the AWRT10RF Thermostat has joined the network, SCANNING--- is displayed with a 10-minute countdown timer showing the time allowed to find all the relay controllers on the network



When the AWRT10RF Thermostat has found all controllers in the network, it will display the default relay controller value (1) and the default zone value (1). If there is more than 1 relay controller on the network, the left value CNTRLR will flash. If there is only one relay controller, the right-hand value for ZONE will flash.

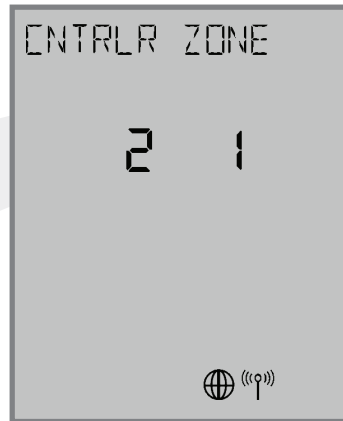

Step 4. Use the \wedge and \vee keys to change the CONTROLLER value, then the \langle or \rangle key to switch to the ZONE.

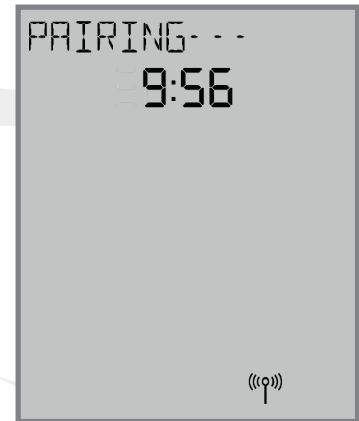

Step 5. Use the \wedge and \vee keys to change the ZONE value, then press SELECT. The AWRT10RF Thermostat will then display PAIRING--- as it associates with the selected controller and zone.

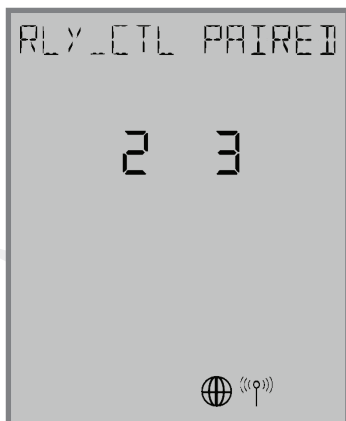

When paired, RLY_CTL PAIRED will be displayed briefly along with the CNTRLR value and ZONE value.



The AWRT10RF Thermostat will enter parameter setup mode, starting with parameter P 01. The current device type along with the Zigbee channel number will be displayed.

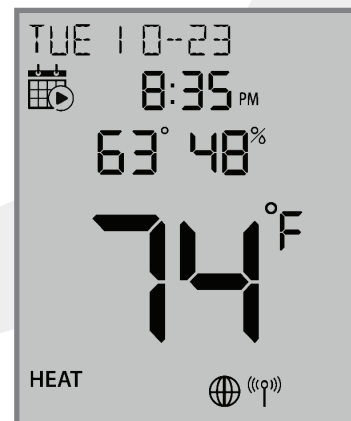

Step 6. Press the \odot key to exit parameter setup and go to the Home Screen. The display shows the current date & time, target temperature, relative humidity, network/internet status and room temperature.

Step 7. Press and hold the lighted flashing button on the AC10RF for 5 seconds until the red LED stops flashing. The AKL Relay Controller and AWRT10RF Thermostat are now paired.

7.2 – Pairing with ARV10RFM or AVA10M30RF Radiator Valve Actuators

Before beginning the pairing process, it is important to be sure that the ARV10RFM or AVA10M30RF Radiator Valve Actuator was installed and adapted properly as detailed in their installation instructions. The following is a review of those instructions.

ARV/AVA Radiator Valve Actuator Installation Review

Step 1. Install the batteries and wait until the LED is solid red before installing the actuator on the radiator valve. Remember that the actuator should only be finger tight on the valve. Using pliers or other tools can damage the device.

Step 2. After attaching the actuator to the valve, press any of the buttons to initialize the ARV/AVA Radiator Valve Actuator. This process may take several minutes, and the valve may continue to initialize after the light is no longer illuminated.



DO NOT BEGIN pairing with the ARV/AVA Radiator Valve Actuator unless the light is out and there is NO MOTOR ACTIVITY. Listen closely to the Valve Actuator to be sure it is not operating before proceeding.

ARV/AVA Radiator Valve Actuator Pairing Procedure

Before pairing, the ARV/AVA Radiator Valve Actuator(s) and AX10RF Receiver (if desired) must be powered in accordance with the installation instructions included with the devices.

- The LED indicator on the ARV/AVA Radiator Valve Actuator(s) should be off with NO MOTOR ACTIVITY.
- If an AX10RF Receiver is used, the LED backlight on the Auto/Manual switch of this device should be flashing red and the switch should be in the AUTO position

Step 1. Press and hold the lighted red pairing button on the AC10RF Coordinator for 5 seconds, until the LED begins flashing.

Step 2. Press and hold the pairing button until the LED indicator begins flashing (approximately 10 seconds) on each ARV/AVA Radiator Valve Actuator to be associated with the AWRT Wireless Radiant Thermostat.



10 seconds



The LED indicator will flash red.

When the ARV/AVA valve actuators join the network, the LED indicator on the Radiator Valve Actuator will turn off.



LED is off.

If an AX10RF Receiver joins the network, the LED backlight on the Auto/Manual switch will stay solid red.

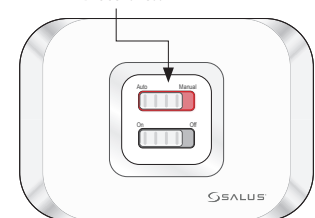

LED is solid red.



A maximum of 6 ARV10RFM or AVA10M30RF Radiator Valve Actuators can be paired with each AWRT10RF Wireless Radiant Thermostat.

Section 7.0

Pairing with Wireless Devices using AC10RF Coordinator (w/o Internet Connection)

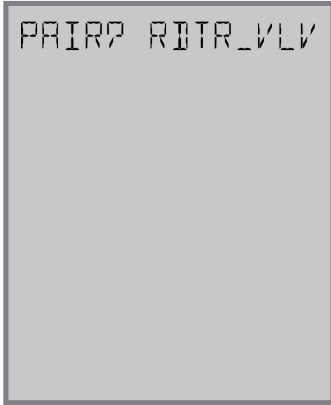

Step 3. Use the \wedge and \vee keys on the AWRT10RF Thermostat to switch from RLAY_CTL to RDTR_VLV. Press SELECT to initiate pairing.



JOINING- - - is displayed with a 10 minute countdown timer to show the remaining time available to complete the next steps. The $\langle\langle\circ\rangle\rangle$ icon will flash at the bottom of the screen indicating that the thermostat is searching for a network to join.

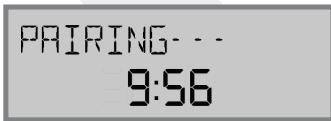

Once the AWRT10RF Thermostat joins a network, the $\langle\langle\circ\rangle\rangle$ icon will stop flashing and the network channel will be briefly displayed. After that, PAIRING- - - is displayed with a 10-minute countdown timer showing the time allowed for the remaining pairing steps.

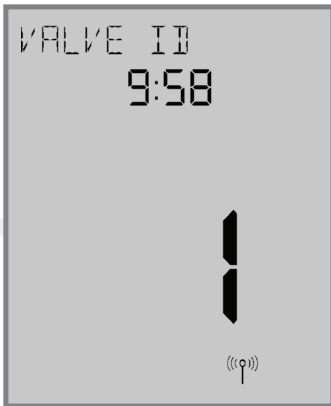

The AWRT Thermostat will display the Valve ID number and a 10-minute timer showing how much time is left to finish pairing.



As each ARV/AVA Valve Actuator is paired with the AWRT Thermostat, the ID number displayed on the screen will increment.



If the user presses the \odot key, the timer times out or 6 valves have been paired, the display will read "RD_VLV PAIRED" for 3 seconds.

Section 7.0

Pairing with Wireless Devices using AC10RF Coordinator (w/o Internet Connection)



After 3 seconds, the AWRT10RF Thermostat will enter the parameter setup mode, starting with P 01 (displayed with RDTR_VLV flashing). The number of radiator valves connected is also displayed.

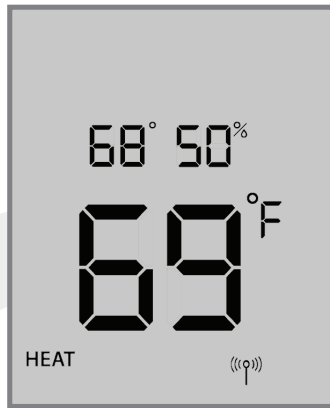

Step 4. Press the  key to exit parameter setup and go to the home screen. The display shows target temperature, relative humidity, room temperature, operation mode and network status.



Step 5. Press & hold the flashing red pairing button on the AC10RF Coordinator for 5 seconds to complete the pairing process.



The AWRT Wireless Radiant Thermostat defaults to Non-programmable mode and doesn't show time or date. For details on changing to programmable mode, see Section 8, Parameter Setup.

7.3 – Pairing with AX10RF Receiver for Boiler Switching (RX1)



- This pairing procedure is only used when direct control of an AX10RF Receiver by the AWRT10RF Thermostat is desired.
- Each system will support only one AX10RF configured as RX1 and one configured as RX2.



The following configuration is typical in boiler systems in which there is only one thermostat in the system such as a single steam heating loop or single forced circulation, hot water loop. For systems with multiple zones, a zone relay controller such as the SALUS AKL Series is recommended.

Before starting the pairing process, be sure that the AX10RF Receiver is installed as shown in the installation instructions included with the device.

- The switch on the inside cover must be configured to RX1.
- The LED backlight on the Auto/Manual switch of the AX10RF Receiver should be flashing red.
- The Auto/Manual switch of the AX10RF Receiver should be in the AUTO position.
- The AWRT10RF Thermostat should be powered up and flashing PAIR? RLAY_CTL.



Step 1. Press and hold the lighted red pairing button on the AC10RF Coordinator for 5 seconds, until the LED begins to flash.



Step 2. On the AWRT10RF Thermostat, press \wedge until PAIR? RCV1 is displayed. Press SELECT.



JOINING - - - will be displayed with a 10 minute countdown timer and a flashing network status indicator.

Section 7.0

Pairing with Wireless Devices using AC10RF Coordinator (w/o Internet Connection)



Once the AWRT10RF Thermostat has joined the network, the screen will show PAIRING- - - with a 5 minute countdown timer.



After pairing is complete, a confirmation screen is displayed for 3 seconds, the AWRT10RF Thermostat enters the parameters set up mode.



The display will show PAIR: RCV1 with P 01 indicating it is in the parameter set up mode. Cn (Connected) indicates that the AX10RF Receiver is paired and connected.

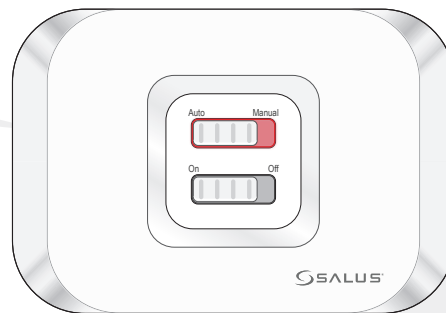
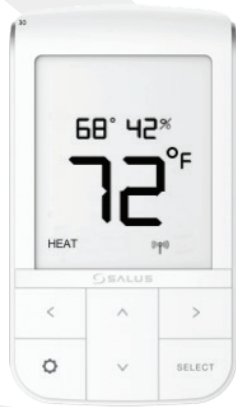

Step 3. Press the  key to exit setup and start normal operation. The AWRT10RF Thermostat display will show the current room temperature, target temperature, relative humidity along with indicators for the temperature mode and network status. The red LED backlight on the Auto/Manual switch will not be flashing.

Step 4. Press the pairing button on the AC10RF Coordinator to exit pairing mode and begin normal operation.



The AWRT Wireless Radiant Thermostat defaults to Non-programmable mode and doesn't show time or date. For details on changing to programmable mode, see Section 8, Parameter Setup.

7.4 – Pairing with AX10RF Receiver for Zone Valve Switching (RX2)



Each system will support only one AX10RF configured as RX1 and one configured as RX2. These two configurations can be used together to provide boiler switching and zone valve operation.

Before starting the pairing process, be sure that the AX10RF Receiver is installed as shown in the installation instructions included with the device.

- The switch on the inside cover must be configured to RX2.
- The LED backlight on the Auto/Manual switch of the AX10RF Receiver should be flashing red.
- The Auto/Manual switch of the AX10RF Receiver should be in the AUTO position.
- The AWRT10RF Thermostat should be powered up and flashing PAIR? RLAY_CTL.



Step 1. Press and hold the lighted red pairing button on the AC10RF Coordinator for 5 seconds, until the LED begins to flash.



Step 2. On the AWRT10RF Thermostat, press \wedge until PAIR? RCV2 is displayed. Press SELECT.



JOINING- - - will be displayed with a 10 minute countdown timer and a flashing network status indicator.

Section 7.0

Pairing with Wireless Devices using AC10RF Coordinator (w/o Internet Connection)



Once the AWRT10RF Thermostat has joined the network, the screen will show PAIRING- - - with a 5 minute countdown timer.



After pairing is complete, a confirmation screen is displayed for 3 seconds, the AWRT10RF Thermostat enters the parameters set up mode.

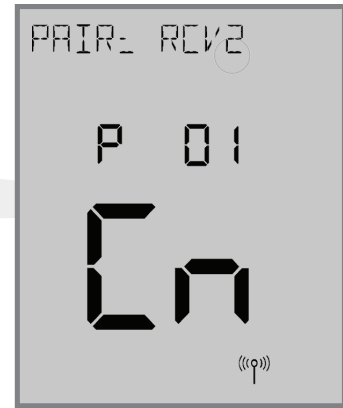

The display will show PAIR: RCV2 with P 01 indicating it is in the parameter set up mode. Cn (Connected) indicates that the AX10RF Receiver is paired and connected.

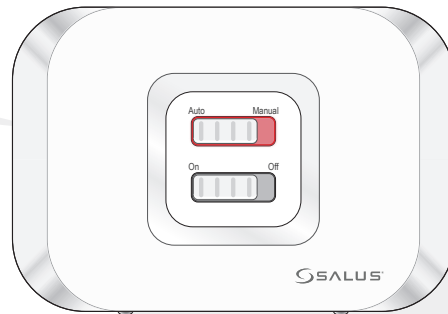

Step 3. Press the  key to exit setup and start normal operation. The AWRT10RF Thermostat display will show the current date & time, target temperature and current room temperature along with indicates for the temperature mode, internet and network status. The red LED backlight on the Auto/Manual switch will not be flashing.

Step 4. Press the pairing button on the AC10RF Coordinator to exit pairing mode and begin normal operation.

8.1 – Parameter & Settings Adjustments using the Display & Keypad

Installers can access parameters on the AWRT10RF using the SALUS Smart Home application if an SG888ZB Gateway is used and connected to the internet. Alternatively, the parameters may be entered directly through the display and keypad on the AWRT10RF Thermostat. The following procedure outlines parameter adjustments using the keypad. Changes made on the SALUS Smart Home application or on the AWRT10RF Thermostat may take a few minutes to go into effect.

Before starting setup procedures, press any key to light the display and prepare the AWRT Thermostat for input.



Settings: Press the  key to enter settings menu. Available settings are shown on the Settings Chart. Use the < or > keys to scroll through available settings.



Time/Date Functions: If S 02 through S 10 are not accessible, change the S 11 value to "49" on the display using the ^ or v keys and press enter. Change item P02 to YES to enable thermostat programming.



Reset to Factory Settings: To reset the AWRT10RF Thermostat to factory settings, change the S 11 value to "86" and choose "Y" to reset.

Generally, once in settings or parameter setup mode, use < and > to move between settings and parameters, and ^ and v to change setting or parameter values. Use SELECT to confirm changes. The table on the following page titled "AWRT10RF Wireless Radiant Thermostat Settings" lists the settings available from the thermostat screen and keypad.



Scheduling functions with date and time are OFF as default for the AWRT Thermostat. To enable the time & date display, choose S11 and push the ^ key until 49 is displayed (holding the ^ or v key will increment/decrement by 10). Use the < and > keys to go to P02 and choose YES to enable the scheduling function.

Table 8.2 – AWRT10RF Wireless Radiant Thermostat Settings

Setting #	Description	Options	Notes
S 01	Temperature Units	°F	Degrees Fahrenheit
		°C	Degrees Celsius
S 03	Clock Format	12-hour	Example- 9:45 pm
		24-hour	Example:- 21:45
S 04	Daylight Savings Time	ON	Automatic Daylight Savings Time Enable
		OFF	Automatic Daylight Savings Time Disable
S 05	Month	01-12	MM Format (DD/MM/YYYY)
S 06	Date	01-31	DD Format (DD/MM/YYYY)
S 07	Year	2018-2099	YYYY Format (DD/MM/YYYY)
S 08	Hour	00-23	HH Format (HH:MM)
		12-11 am/pm	HH Format (HH:MM am/pm)
S 09	Minute	00-59	MM Format (HH:MM or HH:MM am/pm)
S 10	Schedule	WK	Weekly Schedule
		5+2	Weekday/Weekend Schedule
		DAY	Daily Schedule
S11	Parameters	22	Leave Network
		35	Delete Offline Devices
		38	Delete Relay Controllers
		49	Parameter Settings (See Parameter Table on next page)
		86	Reset to Factory Settings
S 12	Identify Mode	99	Rejoin Network
			Press SELECT to Identify Network & Associated Device(s)

Available only when P02 Schedule is enabled

Table 8.3 – AWRT10RF Wireless Radiant Thermostat Parameters

The table below titled AWRT10RF Wireless Radiant Thermostat Parameters lists parameters available from the thermostat screen & keypad.

Para. #	Function	Default	Range	Description
P01	Pair Device	RLAY_CTL	RLAY_CTRL	AKL Relay controllers: Displays controller ID & Zone number
			RDTR_VLV	ARV/AVA Valve Actuators: Displays total # of paired valves
			RCV1	AX10RF Receiver (RX1): Cn = Connected
			RCV2	AX10RF Receiver (RX2): Cn = Connected
P02	Internal Schedule	N (inactive)	N (inactive)	Settings S 03 through S 10 are not available
			Y (active)	Schedule Mode
P03	Temperature Control Method	AUTO	AUTO	RLAY CTL (HEAT), RCV1, RCV2 = TPI RLAY CTRL (COOL) = DLTA 1.0°F (0.5°C) RDTR VLV = DLTA 0.5°F (0.25°C)
			TPI	TPI control is based on the current temperature differential (Proportional) and historical performance (Integral) to determine the next duty cycle percentage.
			DLTA 1.0/0.5	Heat turns on when $T_{room} = T_{setpoint} - \text{Delta}$, Cooling turns on when
			DLTA 0.5/0.25	$T_{room} = T_{setpoint} + \text{Delta}$
P04	Minimum OFF Time	180 seconds	180 - 300 seconds	Minimum period that the thermostat must be off before starting a new cycle to prevent short cycling. (TPI Only)
P08	Temperature Offset	0.0°F or °C	±6.0°F (3.0°C)	Temperature offset for current active temperature sensor
P09	Freeze Protection	41°F (5°C)	41 to 63°F (5 to 17°C) Off	Minimum allowable temperature for the system. Below the specified temperature a heat demand will be signaled.
P10	Maximum Target Temperature	95°F (35°C)	42 to 95°F (5.5 to 35°C)	Maximum allowable temperature setting for heating and cooling mode.
P11	Minimum Target Temperature	41°F (5°C)	41 to 94°F (5 to 34.5°C)	Minimum allowable temperature setting for heating and cooling mode.
P15	External Sensor	OFF (Disabled)	ON (Enable) OFF (Disable)	Enable or Disable external sensor for remote sensing. "EXTERNAL" is only displayed if P16 function is set to "AIR".
P16	External Sensor Function	FLR (Floor)	FLR (Floor) or AIR	Floor temperature is used to control the room temperature based on the room and radiant floor temperature. Air is used when a remote sensor is used in place of the internal thermostat sensor.
P17	Maximum Floor Temperature	81°F (27°C)	52 to 95°F (11 to 35°C)	Maximum temperature that a heat demand will be signaled. P15 must be ON and External Sensor Function must be FLR. Not displayed for RDTR VLV.
P18	Minimum Floor Temperature	50°F (10°C)	41 to 95°F (5 to 35°C)	Minimum temperature that a cooling demand will be signaled. P15 must be ON and External Sensor Function must be FLR. Not displayed for RDTR VLV.

Table 8.3 – AWRT10RF Wireless Radiant Thermostat Parameters (Continued)

Para. #	Function	Default	Range	Description
P19	Radiator Actuator Control	ON/OFF	ON/OFF PI	ON/OFF radiator valve control uses simple proportional control PI radiator valve control is described in detail in the ARV/AVA Radiator Valve Actuator manual. This parameter is only available if P01 = RDTR VLV.
P21	Valve Protection	ON	ON (enabled) OFF (disabled)	When enabled, the radiator valve protection function periodically operates the valve, exercising it to prevent failure. This parameter is only available if P01 = RDTR VLV.
P25	Key Lock Source	KYS+APP	APP	When KYS+APP is selected, parameter P26 (Lock Setpoint) can be activated from either the display and keypad of the AWRT10RF Thermostat by using the SALUS Smart Home application. If APP is chosen, parameter P26 is only available online via the mobile application. This parameter is only available for internet connected thermostats.
P26	Lock Setpoint	Unlock	Unlock Lock	When set to "Lock", the temperature setpoint cannot be changed from the keypad without changing this parameter to "Unlock".

8.4 – Schedule Setup using Display & Keypad



The AWRT10RF Wireless Radiant Thermostat is supplied as a non-programmable thermostat as default. Change P02 above to Y for programmable thermostat functionality.

Step 1. Press the key to enter settings menu. Available settings are shown on the Settings Chart. Use the < or > keys to scroll through available settings.



Step 2. Use the and keys to select the schedule type. See Schedule Option Table below. Press SELECT.

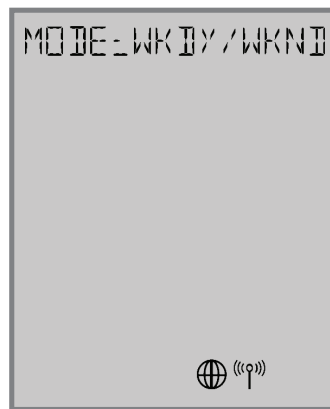

Step 3. Use the and keys to change the schedule Mode if desired. Press SELECT.



Step 4. Use the and keys to change the day or group of days for programming. Press SELECT.

Schedule Options

S10 Selection	Mode Selection	Description
WK	WEEKLY	Temperature schedule for entire week: Monday through Sunday
5+2	WKDY/WKND	Temperature schedule for Weekday (Mon-Fri) and Weekend (Sat-Sun)
DAY	DAILY	Temperature schedule for each day of the week

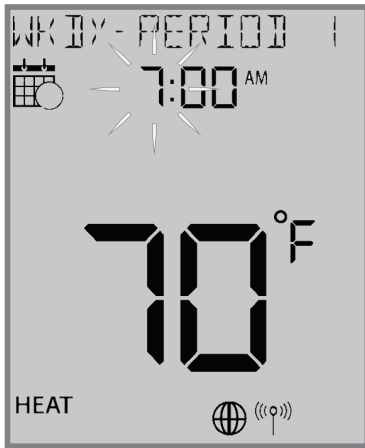

Step 5. Use the \wedge and \vee keys to change the hour to begin the first period. Press SELECT.

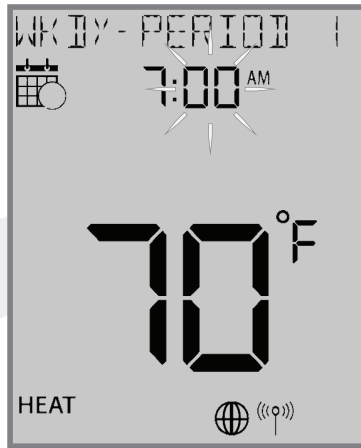

Step 6. Use the \wedge and \vee keys to change the minute to begin the first period. Press SELECT.

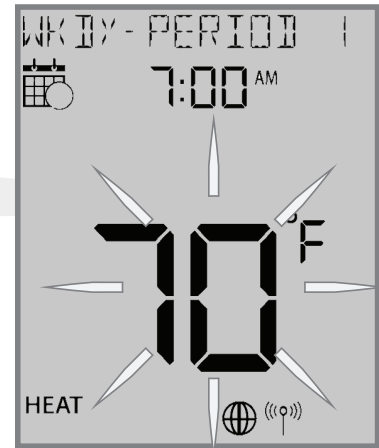

Step 7. Use the \wedge and \vee keys to change the temperature to begin the first period. Press SELECT.

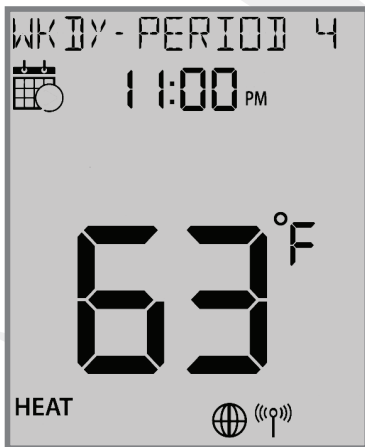

Step 8. Use the $\>$ key to switch to the next period. Set the hour, minute and temperature for each period as desired.

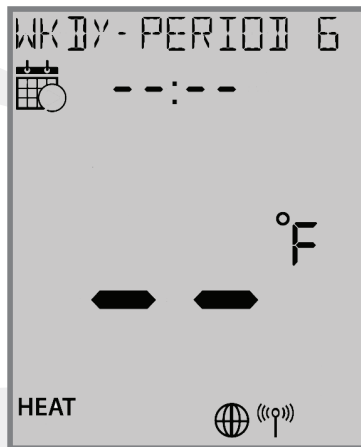

Step 9. Leave the time & temperature fields blank "--" to skip periods that aren't required.

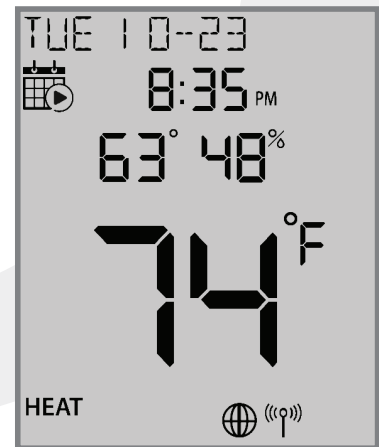

Step 10. Press the \odot key to back out of the menu or simply allow the setting screen to time out after which it will return to the standard display screen.

9.1 – Setting the HVAC Mode using the Display & Keypad



Step 1. Press any key on the keypad to activate the backlit display preparing it for input. Press the < or > key to toggle between HVAC Modes (HEAT/COOL/OFF).



The new mode setting will flash and the current setpoint temperature will appear above the room temperature display. If the mode is OFF, the setpoint will change to 41°F (5°C).

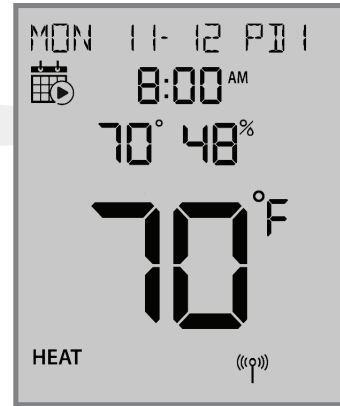

Step 2. Press SELECT to accept the new heat mode. The heat mode stops flashing. If the AWRT10RF Thermostat is setup as programmable, the current time & date will be displayed as well as the schedule icon.

9.2 – Changing the Temperature Setpoint in Non-programmable Mode



Step 1. Press any key on the keypad to activate the backlit display to prepare for input. Press the ^ or v key to adjust the target temperature

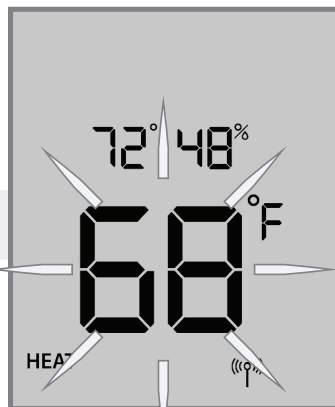

The positions of the setpoint temperature and the current room temperatures are swapped on the display.



Step 2. Press the ^ or v keys to adjust the target setpoint. The new setpoint will take effect once the display stops flashing.

9.3 – Overriding Scheduled Temperature using the Display & Keypad

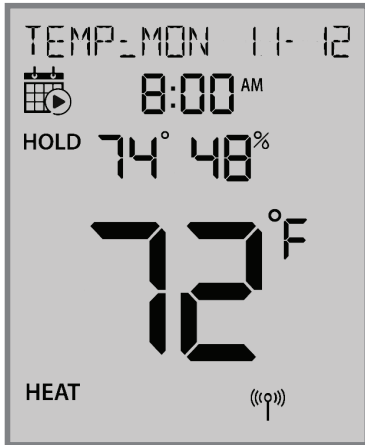

If the setpoint is changed while a schedule is running, the AWRT10RF display will display “TEMP: DAY MM-DD” and show “HOLD”, indicating it is in temporary hold until the next schedule period.



If the temperature change results in a heat demand, the text above will alternate between “Temp: DAY MM-DD” and HEATING- - -.

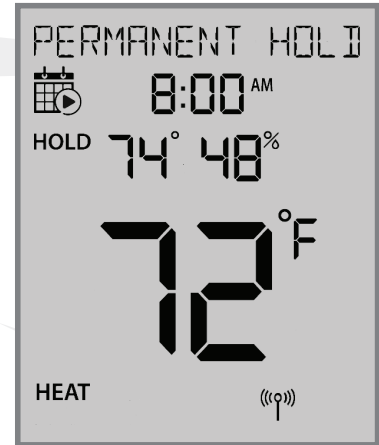

Pressing SELECT while the target setpoint is flashing will toggle “PERMANENT HOLD” which indicates the target temperature will remain as set, ignoring scheduled changes, until changed by the user.

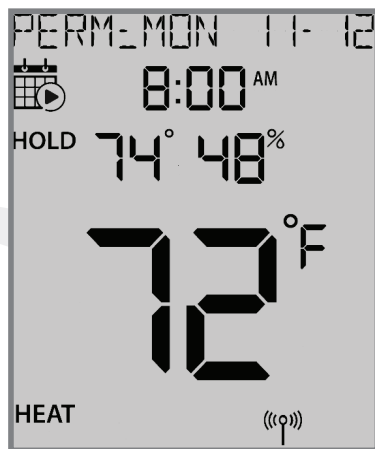

While in Permanent Hold, “PERM: DAY MM-DD” will be displayed along with “HOLD” below the calendar icon.

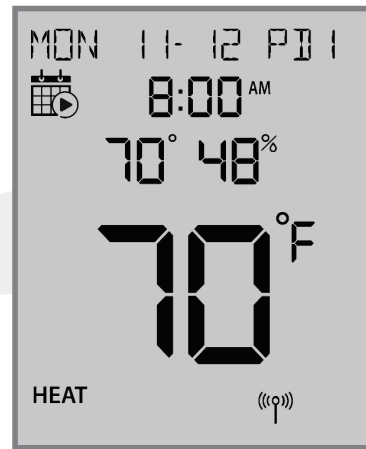

To return to the programmed schedule, use the ^ or v keys to set the temperature to the scheduled temperature. If “PERMANENT HOLD” is displayed, use the select key to toggle it off.

Table 10.1 – Error Messages

Error messages are displayed on the alphanumeric text line at the top of the screen. These messages will alternate with the current status message.

Error Message	Description	Corrective Action
ER:VA DEVICE	Thermostatic Radiator Valve (TRV) hardware issue.	Remove the ARV10RFM or AVA10M30RF Actuator from the radiator valve and check to see if the valve plunger is operating If the plunger is working correctly, try resetting the actuator as described in Section 8
ER:XSNSR OPEN	External Sensor Open – Not Connected: Parameter P15 is enabled for external sensor but no sensor connection is detected.	If no external sensor is used, disable Parameter P15. If an external sensor is used, check continuity of the circuit. Check for wire damage or defective sensor.
ER:XSNSR SHORT	External Sensor Short: Control senses no resistance across sensor.	Check for wire damage creating sensor lead short circuit. Compare sensor resistance to the chart supplied below. If the resistance value is significantly different than predicted by the chart, replace the sensor.
ER:LLNK RC	Lost Link with Relay Controller	Reset the Relay Controller and AWRT10RF Thermostat. Repeat pairing procedure.
ER:LLNK VA #	Lost Link with ARV/AVA valve actuators: # indicates total number of valves	Reset ARV/AVA Actuators and AWRT10RF Thermostat. Repeat pairing procedure.
ER:LLNK RCV1	Lost Link with Receiver: Configured as RX1	Reset AX10RF Receiver and AWRT10RF Thermostat. Repeat pairing procedure.
ER:LLNK RCV2	Lost Link with Receiver: Configured as RX2	Reset AX10RF Receiver and AWRT10RF Thermostat. Repeat pairing procedure.
ER:LLNK ZN #	Lost Link with Thermostat for Zone (1-8) of this Relay Controller	Reset Thermostat corresponding with the ZN message. Repeat pairing procedure.
ER:LLNK RC-CO	Lost Link between Relay Controller and Coordinator/Gateway	Reset Relay Controller. Repeat pairing procedure.
ER:LLNK RC-RCV	Lost Link between Relay Controller and Receiver (RX1)	Reset Receiver and repeat pairing procedure.
ER:LLNK VA-CO	Lost Link between ARV/AVA Valve Actuator and Coordinator	Reset ARV/AVA Actuator
ER:LOWBAT VA	Low Battery ARV/AVA Actuator	Replace batteries in the ARV/AVA Actuator.
ER:VA GEAR	Gear Issue with ARV/AVA Valve Actuator	Replace the ARV/AVA Actuator.
ER:VA ADAPT	Issue with adapting ARV/AVA Actuator and valve combination	Reset ARV/AVA Actuator and Thermostat and repeat the Pairing procedure.

10.2 – Reading Multiple Error Messages

If there is more than one error, the AWRT10RF Thermostat will show the number of errors on the text message line alternating with the standard display.

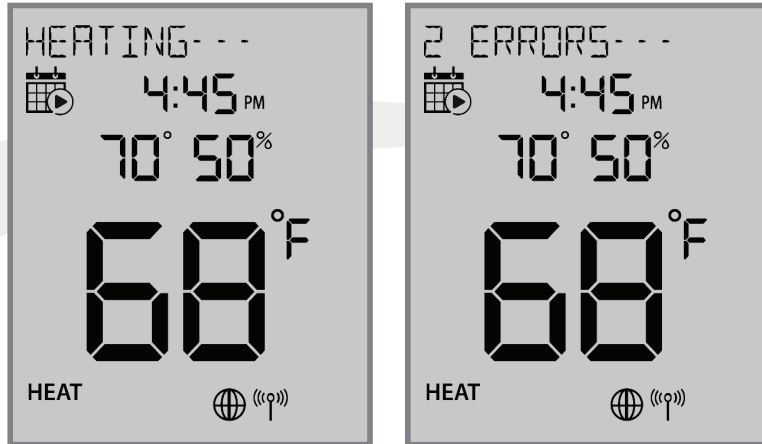

Pressing the ^ and v keys while the "# ERRORS" message is displayed allows review of all errors. The lower number indicates the error sequence.

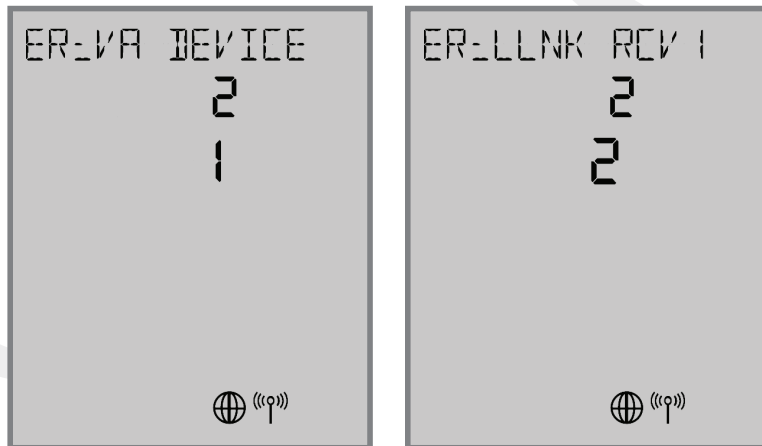
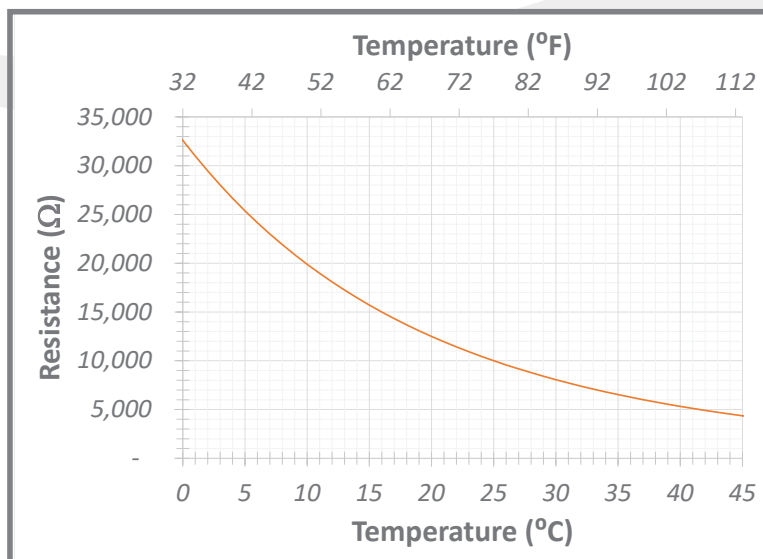
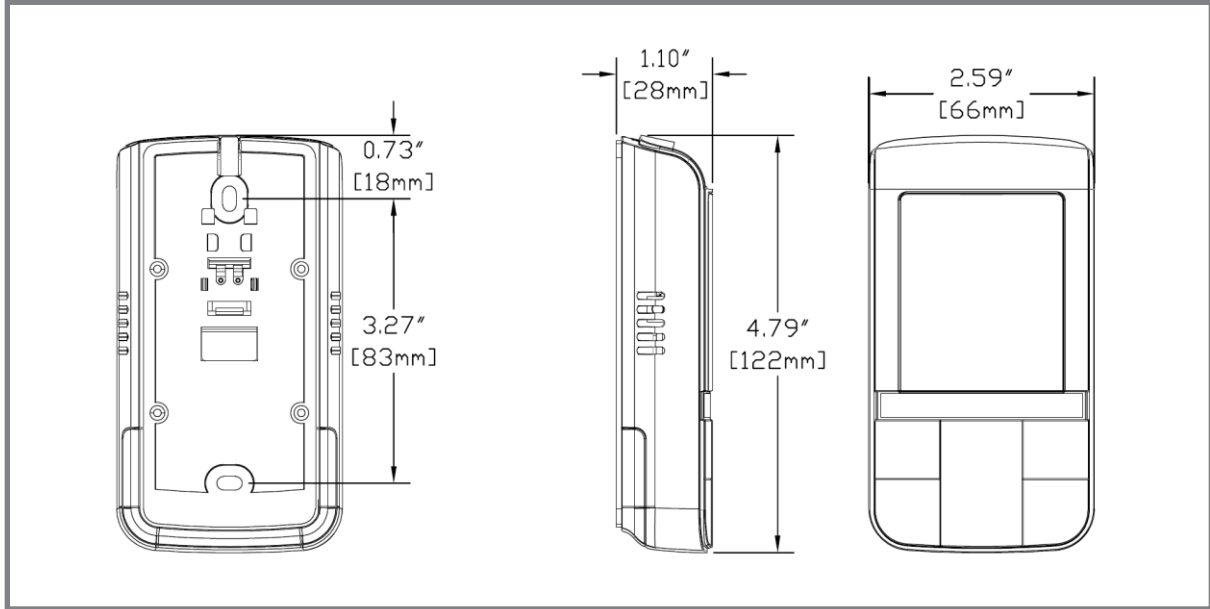

Figure 10.3 – Optional External Sensor Resistance Graph

External Sensor Resistance vs. Temperature



Thermostat Dimensions



Specifications

	<i>Length</i>	<i>Width</i>	<i>Height</i>	<i>Weight</i>
Package Dimensions	6.18"	2.68"	1.38"	0.5 Lbs
	15.7 cm	6.8 cm	3.5 cm	225 g
Enclosure Material	White PC/ABS Plastic			
Approvals	Meets Class B ICES & FCC Part 15			
Operating Temperature	Indoor use only, 32 to 122°F (0 to 50°C), RH <90% noncondensing			
Storage Temperature	14 to 140°F (-10 to 60°C)			
Power Supply	2 x AA Batteries			
Temperature Sensor	Internal thermistors, 10 kΩ @ 77°F (25°C ± 0.2°C)			
	Measurement Range: 32 - 99°F (0 - 40°C)			
	Resolution: 1°F (0.5°C)			
User Interface	Set Point Range: Heating: 41 - 92°F (5 - 33.5°C) / Cooling: 44 - 95°F (6.5 - 35°C)			
	Controls: < ^ v > ⚙ SELECT			
	Indications: Temperature, Day of the Week, Heat/Cool, Settings, Key Lock			
	Backlit fixed segment LCD Display			
	User settings stored in non-volatile memory			



