



Logitech® *Bluetooth*® Audio Adapter
Logitech® Adaptateur audio *Bluetooth*®

Product Manual | Manuel du produit



English	3
Français	8
Español	13
Português	18

www.logitech.com/support

 What's in the box

1

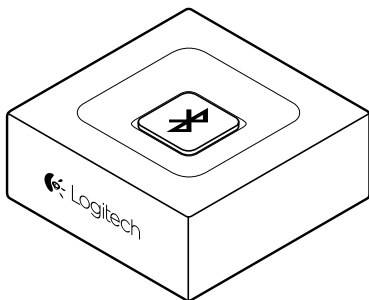

2

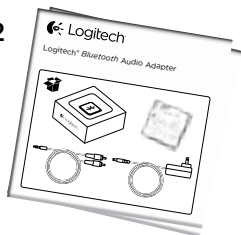

3

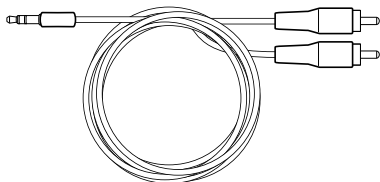

4

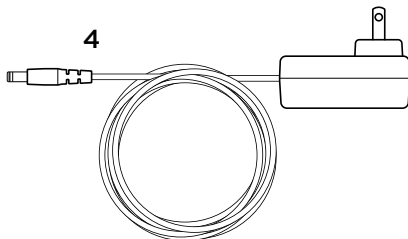

1. Logitech *Bluetooth*® Audio Adapter
2. User documentation

3. RCA to 3.5mm cable
4. Power adapter

✖ Set-up

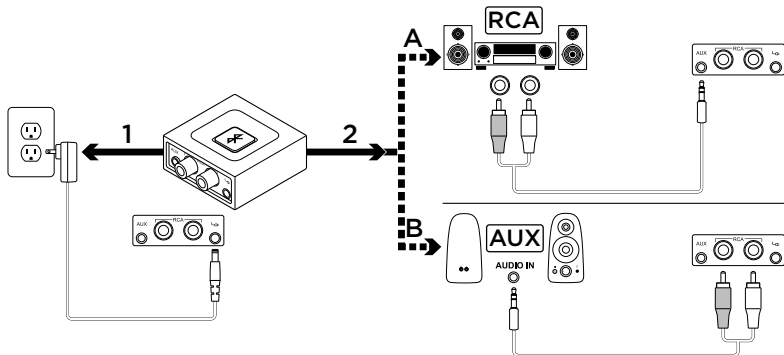

1. Connect the power supply to the Logitech *Bluetooth* Audio Adapter. Then plug the power cord into electrical outlet.
2. A. If you have RCA outlet on your Speaker System then:
 - Connect RCA jack on the Speaker.
 - Connect the other hand of the cable to Logitech *Bluetooth* Audio Adapter.
- B. If you have 3.5mm outlet on your Speaker System then:
 - Connect 3.5mm jack on the Speaker.
 - Connect the other hand of the cable to Logitech *Bluetooth* Audio Adapter.

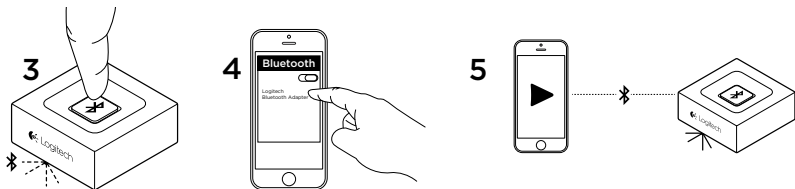

3. Press the *Bluetooth* pairing button on Logitech *Bluetooth* Audio Adapter. It will initiate the pairing and the LED will start blinking (for first time user, the pairing process will be initiated automatically).
4. Turn the *Bluetooth* mode ON (on your device) and scan for *Bluetooth* devices. You will see "Logitech BT Adapter" on the device list. Select and connect to it. "Logitech BT Adapter" will display a connected status.
5. The LED will turn into steady blue. You can now play music through your audio device wirelessly!



Connecting to two devices simultaneously

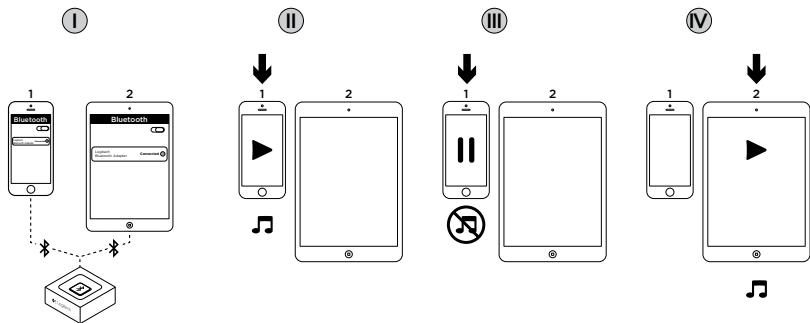

- I. Make sure that your two devices are connected to Logitech *Bluetooth* Audio Adapter following step 1 to 5 of the set-up. In case you were disconnected, please check your *Bluetooth* device list, select “Logitech BT Adapter” and reconnect.
- II. Play music on device 1.
- III. Stop playing music on device 1.
- IV. Start playing music on device 2, the audio would switch automatically and will stream from device 2. It may take a few seconds to switch between devices.

Reconnecting a *Bluetooth* device

Logitech *Bluetooth* Audio Adapter will reconnect automatically to the latest connected device.

If you are not using the latest connected device and you want to reconnect to Logitech *Bluetooth* Audio Adapter, you need to select Logitech *Bluetooth* Audio Adapter in your *Bluetooth* device list on your device (1). You are then connected again to Logitech *Bluetooth* Adapter and can stream music again from your device (2).

Add devices

Logitech *Bluetooth* Audio Adapter can store up to eight *Bluetooth* devices in its memory (Two devices can connect simultaneously).

For setting-up each device, follow the set-up instructions.

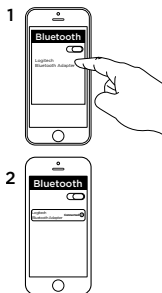

 Contenu du coffret

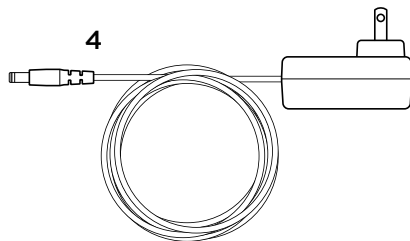
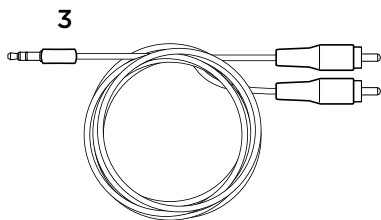
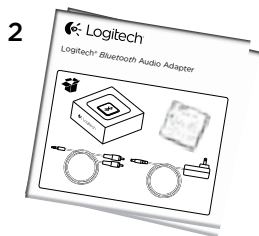
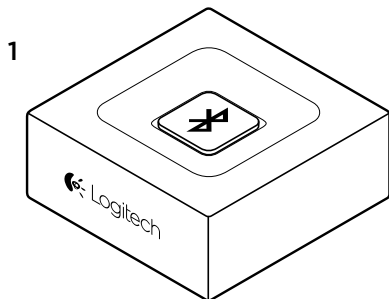

1. Logitech *Bluetooth*® Audio Adapter
2. Documentation utilisateur

3. Câble RCA vers 3,5 mm
4. Adaptateur secteur

✖ Installation

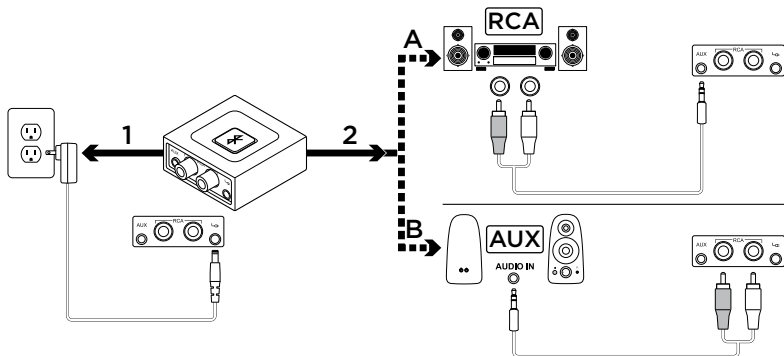

1. Branchez l'alimentation à l'adaptateur Logitech *Bluetooth* Audio Adapter. Branchez ensuite le cordon d'alimentation sur la prise électrique.
2. A. Si vous avez une prise RCA sur votre système de haut-parleurs:
 - Branchez la prise RCA sur le haut-parleur.
 - Connectez l'autre extrémité du cordon à l'adaptateur Logitech *Bluetooth* Audio Adapter.
- B. Si vous avez une prise de 3,5 mm sur votre système de haut-parleurs:
 - Branchez la prise de 3,5 mm sur le haut-parleur.
 - Connectez l'autre extrémité du cordon à l'adaptateur Logitech *Bluetooth* Audio Adapter.

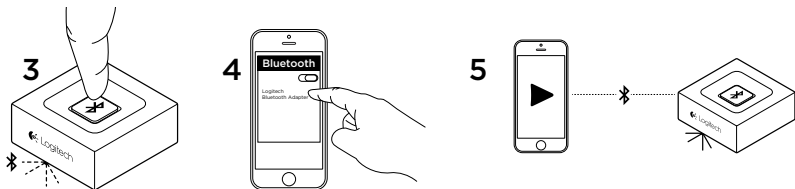

3. Appuyez sur le bouton de couplage *Bluetooth* sur l'adaptateur Logitech *Bluetooth* Audio Adapter. Le couplage démarre et le témoin lumineux commence à clignoter. Lors de la première utilisation, le processus de couplage démarre automatiquement.
4. Activez le mode *Bluetooth* sur votre dispositif et recherchez d'autres dispositifs *Bluetooth*. Dans la liste des dispositifs, vous devriez voir "Logitech BT Adapter". Sélectionnez-le et connectez-vous au dispositif. "Logitech BT Adapter" doit être affiché comme étant connecté.
5. Le témoin lumineux s'allume en bleu et reste fixe. Vous pouvez désormais écouter la musique de vos dispositifs audio sans fil!



Connexion à deux dispositifs simultanément

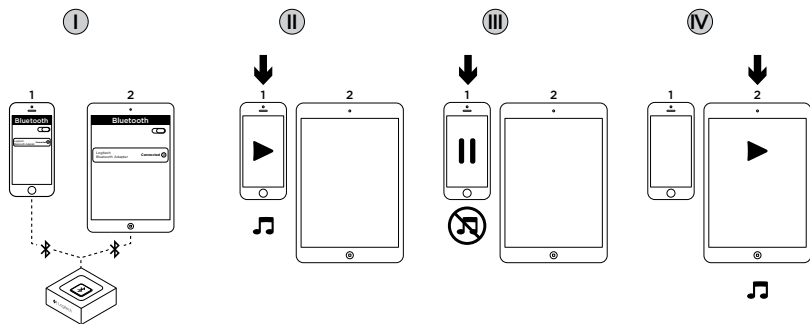

- I. Vérifiez que vos deux dispositifs sont connectés à l'adaptateur Logitech *Bluetooth* Audio Adapter comme indiqué dans les étapes 1 à 5 de l'installation. Si vous avez été déconnecté, accédez à la liste des dispositifs *Bluetooth* disponibles, sélectionnez "Logitech BT Adapter" et reconnectez-vous.
- II. Démarrez la lecture de la musique sur le dispositif 1.
- III. Arrêtez la lecture de la musique sur le dispositif 1.
- IV. Démarrez la lecture de la musique sur le dispositif 2, le dispositif bascule automatiquement et joue la musique du dispositif 2. Le basculement entre les deux dispositifs peut prendre quelques secondes.

Reconnexion d'un dispositif *Bluetooth*

L'adaptateur Logitech *Bluetooth* Audio Adapter se reconnecte automatiquement au dernier dispositif connecté.

Si vous n'utilisez pas le dernier dispositif connecté et que vous souhaitez vous reconnecter à l'adaptateur Logitech *Bluetooth* Audio Adapter, vous devez sélectionner Logitech *Bluetooth* Audio Adapter dans la liste de dispositifs *Bluetooth* de votre dispositif (1). Vous êtes alors reconnecté à l'adaptateur Logitech *Bluetooth* Adapter et vous pouvez à nouveau lire de la musique à partir de votre dispositif (2).

Ajout de dispositifs

L'adaptateur Logitech *Bluetooth* Audio Adapter peut conserver jusqu'à 8 dispositifs *Bluetooth* en mémoire et vous pouvez y connecter 2 dispositifs simultanément.

Pour l'installation de chaque dispositif, suivez les instructions d'installation.

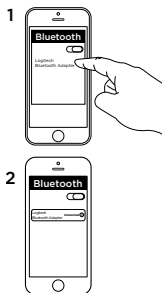

Contenido de la caja

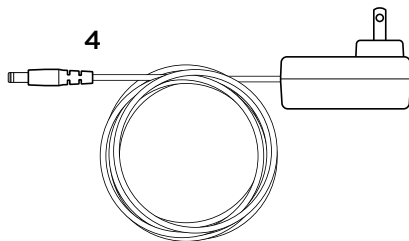
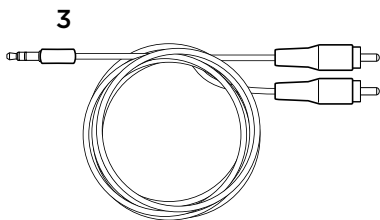
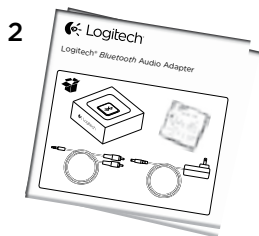
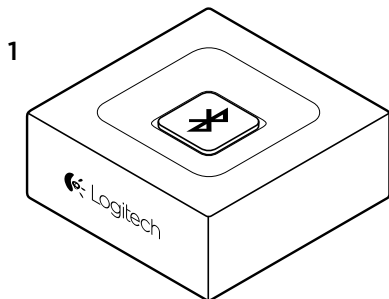

1. Logitech *Bluetooth*® Audio Adapter
2. Documentación del usuario

3. Cable RCA a 3,5 mm
4. Adaptador de corriente

✖ Instalación

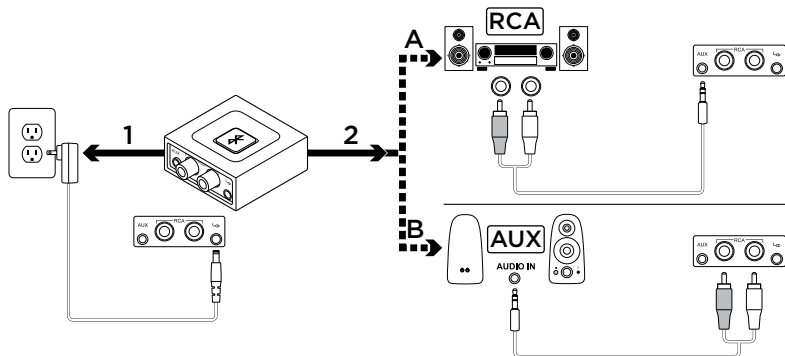

1. Conecta la fuente de alimentación a Logitech *Bluetooth* Audio Adapter. A continuación, conecta el cable de alimentación a una toma de corriente.
2. A. Si tienes una toma RCA en el sistema de altavoces:
 - Conecta la toma RCA en el altavoz.
 - Conecta el otro extremo del cable a Logitech *Bluetooth* Audio Adapter.
- B. Si tienes una toma de 3,5 mm en el sistema de altavoces:
 - Conecta la toma de 3,5 mm en el altavoz.
 - Conecta el otro extremo del cable a Logitech *Bluetooth* Audio Adapter.

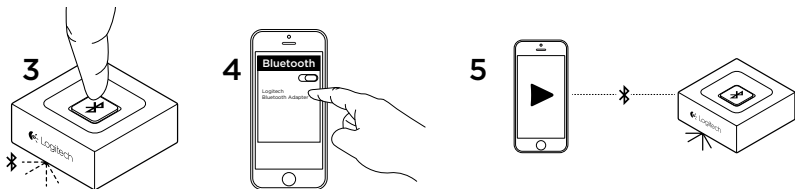

3. Pula el botón de emparejamiento *Bluetooth* en Logitech *Bluetooth* Audio Adapter. Se iniciará el emparejamiento y el LED emitirá destellos (cuando se usa por primera vez, el proceso de emparejamiento se inicia automáticamente).
4. Activa el modo *Bluetooth* ("ON" en el dispositivo) y busca dispositivos *Bluetooth*. Verás "Logitech BT Adapter" en la lista de dispositivos. Selecciónalo y realiza la conexión al mismo. "Logitech BT Adapter" mostrará un estado conectado.
5. El LED permanecerá iluminado en azul. Entonces podrás reproducir música de forma inalámbrica mediante el dispositivo de audio.



Conexión de dos dispositivos simultáneamente

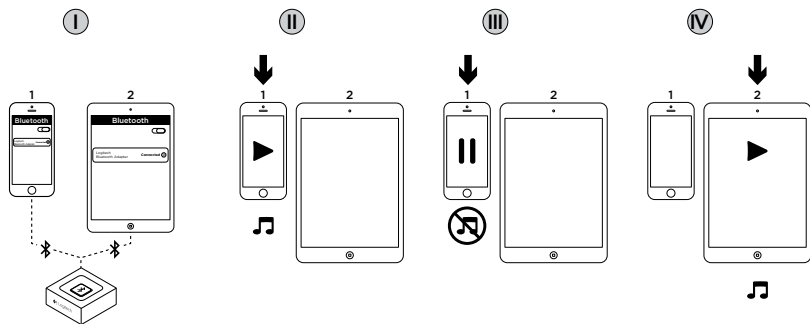

- I. Certece de que los dos dispositivos estén conectados a Logitech *Bluetooth* Audio Adapter siguiendo los pasos 1 a 5 de la instalación. Si no hubiera conexión, consulta la lista de dispositivos *Bluetooth*, selecciona "Logitech BT Adapter" y repite la conexión.
- II. Reproduce música en el dispositivo 1.
- III. Detén la reproducción de música en el dispositivo 1.
- IV. Comienza a reproducir música en el dispositivo 2. El audio cambiará automáticamente y se transmitirá desde el dispositivo 2. El cambio entre dispositivos puede tardar unos segundos.

Reconectar un dispositivo *Bluetooth*

Logitech *Bluetooth* Audio Adapter se volverá a conectar automáticamente al dispositivo que se conectó más recientemente.

Si no vas a usar el dispositivo que se conectó más recientemente y deseas volver a conectarte a Logitech *Bluetooth* Audio Adapter, debes seleccionar Logitech *Bluetooth* Audio Adapter en la lista de dispositivos *Bluetooth* en el dispositivo (1). Te volverás a conectar a Logitech *Bluetooth* Adapter y podrás hacer streaming nuevamente desde el dispositivo (2).

Agregar dispositivos

Logitech *Bluetooth* Audio Adapter puede almacenar hasta ocho dispositivos *Bluetooth* en su memoria (se pueden conectar dos dispositivos simultáneamente).

Para configurar cada dispositivo, sigue las instrucciones de instalación.

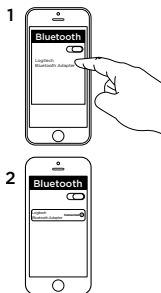

 O que a caixa contém

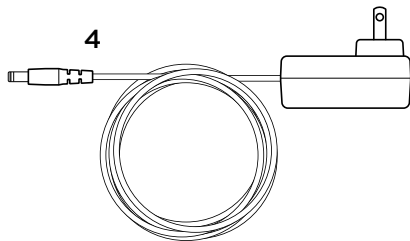
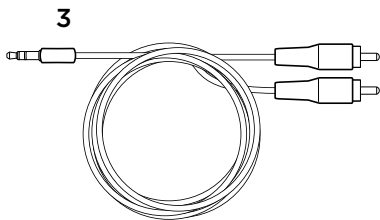
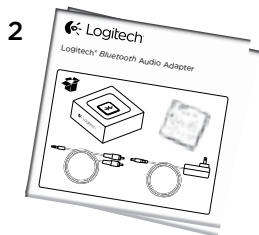
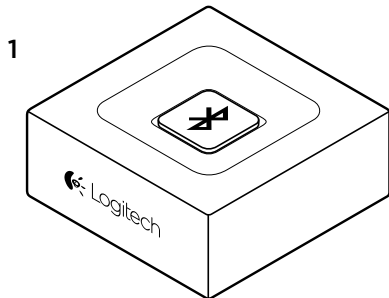

1. Adaptador de Áudio *Bluetooth*® da Logitech
2. Documentação do usuário

3. Cabo de áudio RCA de 3,5 mm
4. Adaptador de força

✖ Configuração

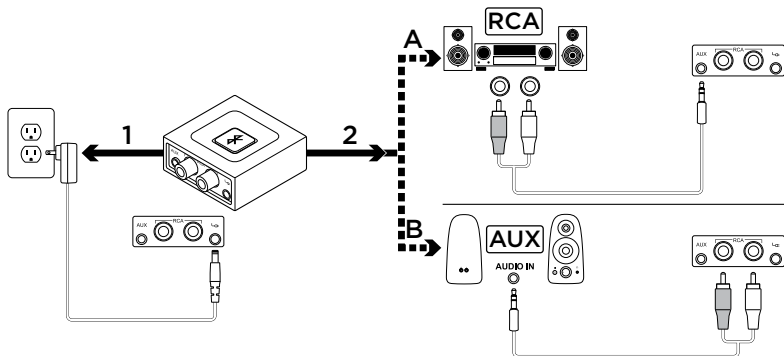

1. Conecte a fonte de alimentação ao adaptador de áudio *Bluetooth* da Logitech. Ligue o fio de alimentação a uma tomada.
2. A. Se você tiver uma entrada RCA no alto-falante:
 - Conecte a entrada RCA no alto-falante.
 - Conecte a outra extremidade do cabo ao adaptador de áudio *Bluetooth* da Logitech.
- B. Se você tiver uma tomada de 3,5 mm no alto-falante:
 - Conecte a entrada de 3,5 mm no alto-falante.
 - Conecte a outra extremidade do cabo ao adaptador de áudio *Bluetooth* da Logitech.

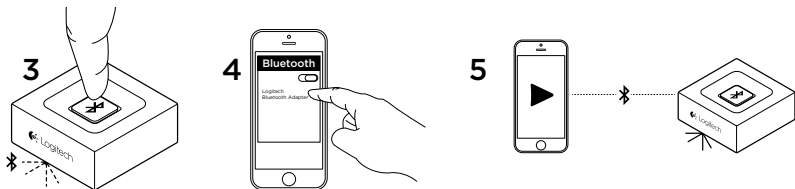

3. Pressione o botão de emparelhamento no adaptador de áudio *Bluetooth* da Logitech. O emparelhamento será iniciado e o LED começará a piscar (o processo de emparelhamento será iniciado automaticamente na primeira vez).
4. Ligue o *Bluetooth* (no dispositivo) e verifique os dispositivos *Bluetooth*. Você verá "Logitech BT Adapter" na lista de dispositivos. Selecione essa opção e conecte-se. O status do "Logitech BT Adapter" será exibido como conectado.
5. O LED exibirá um azul estável. Agora você já pode reproduzir músicas sem fio através do seu dispositivo de áudio!



Conexão com dois dispositivos simultaneamente

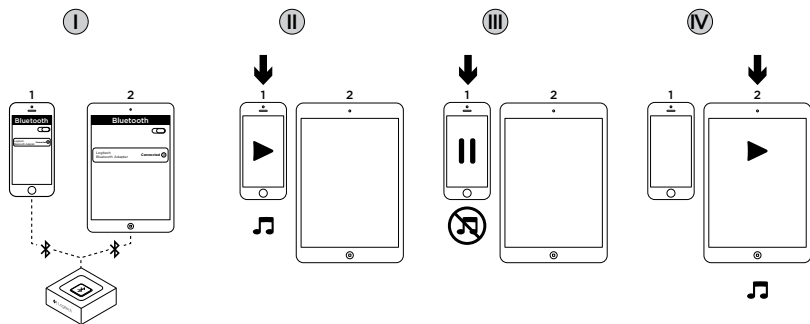

- I. Certifique-se de que os dois dispositivos estão conectados ao adaptador de áudio *Bluetooth* da Logitech seguindo as etapas 1 - 5 da configuração. Caso você perca a conexão, verifique a lista de dispositivos *Bluetooth*, selecione "Logitech BT Adapter" e conecte novamente.
- II. Reproduza música no dispositivo 1.
- III. Interrompa a música no dispositivo 1.
- IV. Comece a reproduzir músicas no dispositivo 2. O áudio será alternado automaticamente e será transmitido pelo dispositivo 2. A troca entre dispositivos pode demorar alguns segundos.

Reconectar um dispositivo *Bluetooth*

O Adaptador de áudio *Bluetooth* da Logitech será reconectado automaticamente ao dispositivo conectado mais recentemente.

Se você não estiver usando o dispositivo conectado mais recentemente e quiser reconectar o adaptador de áudio *Bluetooth* da Logitech, é necessário selecionar este na lista de dispositivos no seu dispositivo (1). Você será conectado novamente ao adaptador *Bluetooth* e poderá transmitir músicas pelo dispositivo (2).

Adicionar dispositivos

O Adaptador de áudio *Bluetooth* da Logitech pode armazenar até oito dispositivos *Bluetooth* em sua memória (dois dispositivos podem estar conectados simultaneamente).

Para conhecer a configuração de cada dispositivo, siga as instruções de configuração.

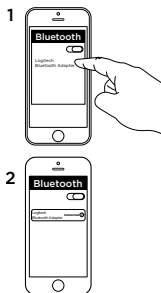



www.logitech.com/support/bluetooth-audio-adapter

© 2014 Logitech. All rights reserved. Logitech, the Logitech logo, and other Logitech marks are owned by Logitech and may be registered. *Bluetooth*® is a registered trademark of Bluetooth SIG, Inc. All other trademarks are the property of their respective owners. Logitech assumes no responsibility for any errors that may appear in this manual. Information contained herein is subject to change without notice.

© 2014 Logitech. Tous droits réservés. Logitech, le logo Logitech et les autres marques Logitech sont la propriété de Logitech et sont susceptibles d'être déposés. *Bluetooth*® est une marque déposée de Bluetooth SIG, Inc. Toutes les autres marques commerciales sont la propriété de leurs détenteurs respectifs. Logitech décline toute responsabilité en cas d'erreurs dans ce manuel. Les informations énoncées dans ce document peuvent faire l'objet de modifications sans avis préalable.

621-000363.002