

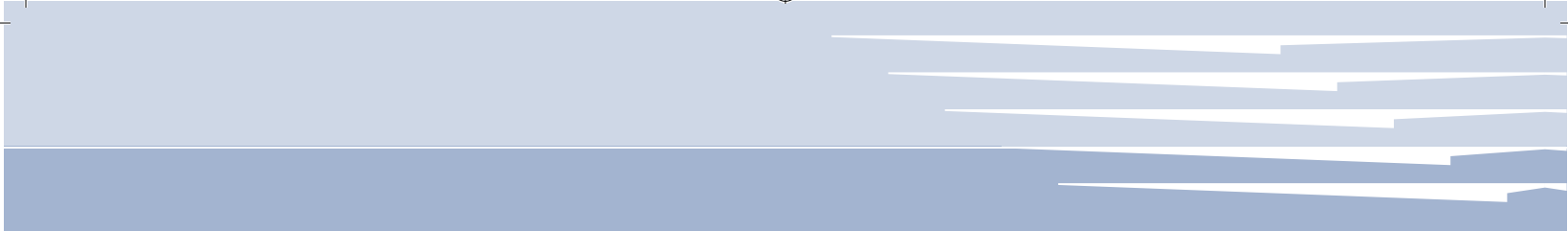

USER MANUAL
Wines Cellars

Fhiaba



Page	2	1 Important instructions for safety and the environment
		1.1 For your safety
		1.2 Respect for the environment
	3	2 Installation
		2.1 Installation
		2.2 Connection to the electrical mains
	4	3 Before starting
		3.1 Getting to know the appliance
		3.2 Main features
		3.3 Main components
		3.4 Electronic Control
		3.5 Main control panel
	8	4 Turning the appliance on and off
		4.1 Turning on and off
		4.2 How to adjust the temperature to suit various needs
		4.3 Information and malfunction signals on the display
	10	5 Settings and Special Functions
		5.1 Customization and Language Settings
		5.2 Special functions activated through the Menu
		5.3 Basic settings of the Menu
	15	6 Internal Layout
		6.1 Internal Layout (positioning, adjustment, removal)
	16	7 Lighting
		7.1 Lighting
	17	8 Use of the TriMode compartment
		8.1 Use of the TriMode compartment
		8.2 TriMode compartment
	18	9 Conservation of wines
		9.1 General directions
		9.2 Wine conservation temperature
		9.3 Time of conservation
		9.4 Consumption temperature
		9.5 Position of bottles
	21	10 Food Conservation
		10.1 Recommendations for conserving fresh food
		10.2 Recommendations for conserving frozen food
	22	11 Recommended times for food conservation
	23	12 Care and Cleaning
		12.1 Care and Cleaning
		12.2 Condenser cleaning
		12.3 Internal cleaning
	24	13 Troubleshooting guide
		13.1 Troubleshooting guide
		13.2 Malfunction indications appearing on the display
	26	14 Prior to calling Service
		14.1 Prior to calling Service
	27	15 Fhiaba Access Menu Map
		15.1 Functions
		15.2 Settings

1 Important instructions for safety and the environment

1.1 For your safety



Notes

Suggestions for proper use of the appliance



Important

Instruction to prevent damage to the appliance



Warning

Instructions for preventing personal injury

■ If this appliance is replacing an existing appliance which must be removed or disposed of, make sure that it does not become a dangerous trap for children by cutting its power supply cable and rendering it impossible to close the door. Use the same caution at the end of the lifespan of the new appliance.

■ This appliance is designed to refrigerate beverages and foods and is destined for domestic use.

■ The appliance must be installed by following the instructions in the Installation Guide, particular care should be taken not to obstruct the vent openings of the appliance and of the built-in units.

■ The appliance features a concentrated lighting system with LED lamps. Do not stare into these lamps when they are on to avoid possible eyesight damage. This warning is also contained on the label attached to the inside of the refrigerator door.

■ When the freezer is functioning do not touch the inner surfaces in stainless steel with wet or damp hands, since skin may stick to the very cold surfaces.

■ Do not use any type of electrical equipment inside of the food conservation compartments.

■ When positioning the shelves, do not place fingers in the shelf slide guides.

■ Do not position containers of flammable liquids near the appliance.

■ Completely switch off the appliance and unplug the power supply cable during cleaning operations. If the plug is not easily reached, it is a good idea to disconnect the omnipolar switch that controls the socket that the appliance is connected to.

■ The packaging parts can be dangerous for children: do not allow children to play with the plastic bags, plastic film or Styrofoam.

■ Any repairs must be performed by a qualified Fhiaba Service technician.

■ This appliance is not intended for use by persons (including children) with reduced physical, sensory or lack of experience and knowledge unless they have been given supervision or instruction concerning use of the appliance by a person responsible for their safety. Children should be supervised to ensure that they do not play with the appliance.

■ Do not damage the appliance refrigerant circuit pipes.

■ Do not store explosive substances such as aerosol cans with a flammable propellant in this appliance.

Respect for the environment 1.2



- Make sure you dispose properly of all packing materials.
- The appliance must not be disposed of with urban waste. Contact local waste disposal authorities for information on the disposal of recyclable waste.
- For disposal, cut the power supply cord and make it impossible to close the door.
- During disposal, avoid damage to the refrigeration circuit.
- Neither the refrigeration circuit nor the insulation contain substances that are hazardous to the ozone layer

Installation 2.1

Make sure that installation is performed correctly, adhering to all of the instructions in the specific installation guide provided with the appliance.

Connection to the electrical mains 2.2

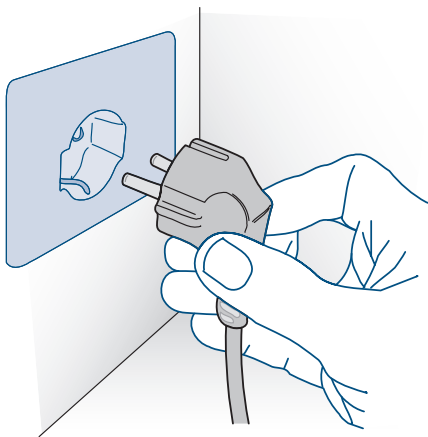

The appliance is equipped with a Schuko type 16A plug.

It must be connected to the electrical mains by means of a corresponding Schuko socket.

Do not use extension cords and/or multiple adapters for connection.



Do not use extension cords and/or multiple adapters for connection.



If energy is supplied through an alternative energy power source (solar, geothermal, etc..) or if home automation systems are installed, it is necessary to install the Alternative Energy Kit to integrate the unit into the power grid.

3 Before starting

3.1 Getting to know the appliance

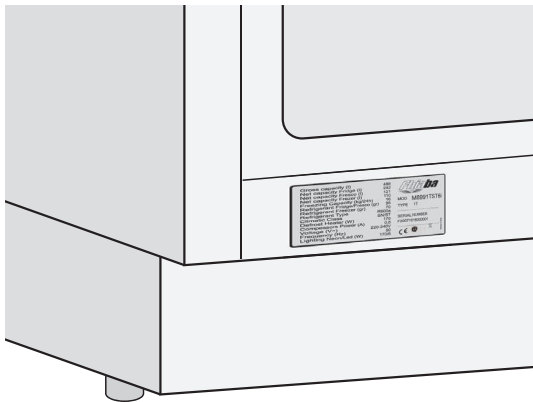

Congratulations for having purchased your new Fhiaba: from now on you can use our innovative conservation system, which will allow you to keep all of your food in the best way possible.

This manual will answer most of your questions about the product's features. Should you require further information, please check our website

www.fhiaba.com

or write us an e-mail at

care@fhiaba.com.

Before calling, write down the model type and serial number which are available on the warranty certificate and on the rating plate located on the bottom left-hand corner of the appliance, behind the bottom drawer and any messages which may have appeared on the display.

+39 0434 420 160

3.2 Main features

- Exclusive design by Giugiaro
- The Fhiaba triple refrigeration system and the separation of internal compartments ensure perfect conditions for conservation of various types of wines
- The electronic control guarantees constant temperature and humidity levels set by the user
- The double compressor allows separate management of the set temperature and humidity for the Cantina, Wine Cellar and TriMode compartments
- The TriMode compartment may operate in three different modes: as a freezer, as a refrigerator or as a cooler compartment
- Free-standing or built-in installation
- An interactive menu (Menu) permits personalized management of appliance functions and the display of messages on operation
- Optimization of consumption during vacation periods
- Surfaces in stainless steel both inside and outside, with fine aluminium trim
- Patented hinge system that permits automatic door closing
- TriMode drawers with Soft self-closing system
- Localized lighting system with LEDs
- Anti-tipping system with brackets for wall mounting.

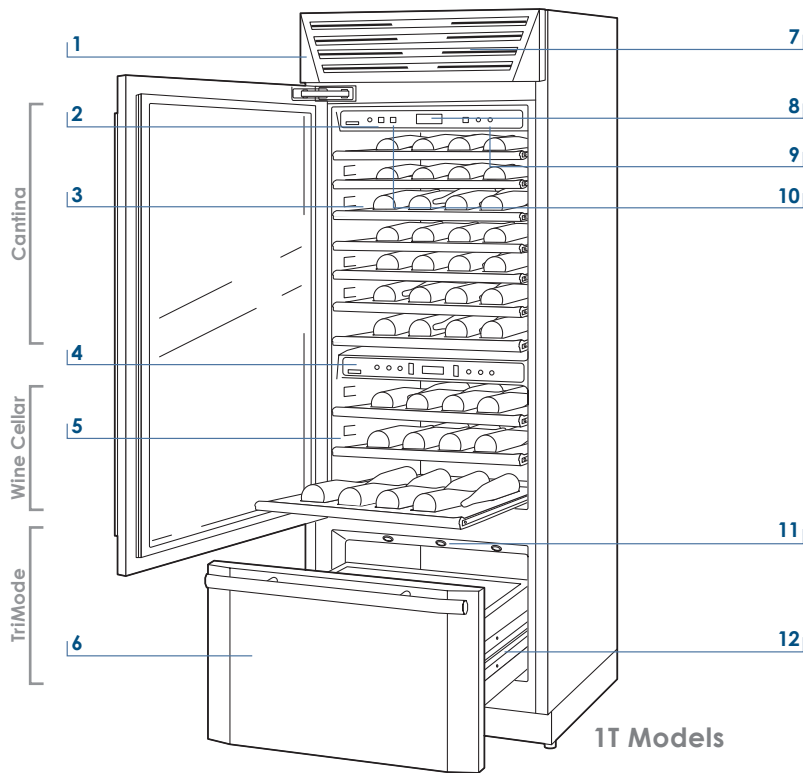

One drawer Wine Cellar

- 1 Structure in stainless steel with aluminium trim
- 2 Wine Cellar and TriMode control panels with Menu
- 3 Sliding bottle shelves, mounted on wheels for easy extraction
- 4 Cantina area control panel
- 5 Wine Cellar
- 6 Freezer compartment that can be transformed into a refrigerator or Crisper-Fresco compartment (TriMode function)
- 7 Double refrigeration system
- 8 Temperature display
- 9 Acoustic signals
- 10 Vacation function (in Menu)
- 11 Innovative lighting
- 12 Automatic door and drawer closure

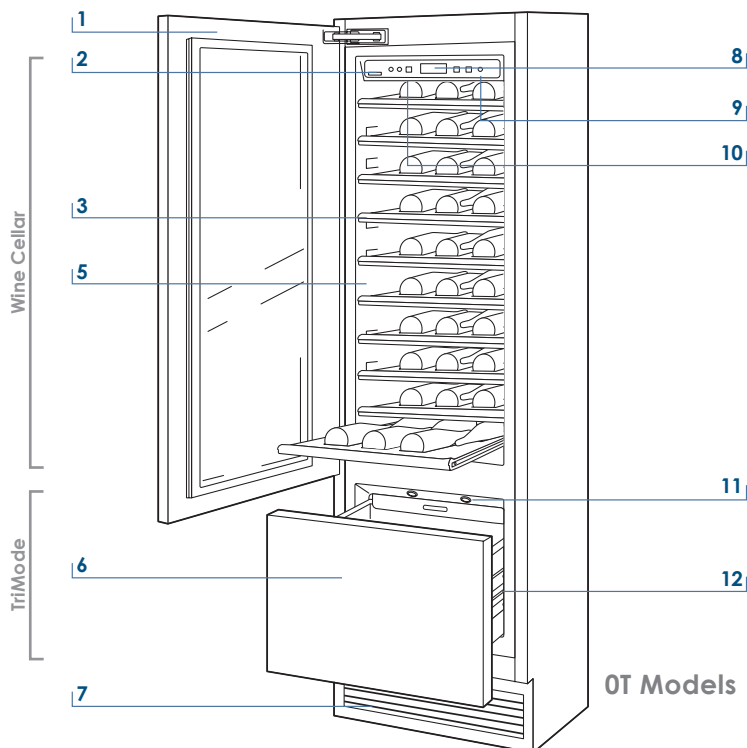

3 Before starting

3.3 Main components

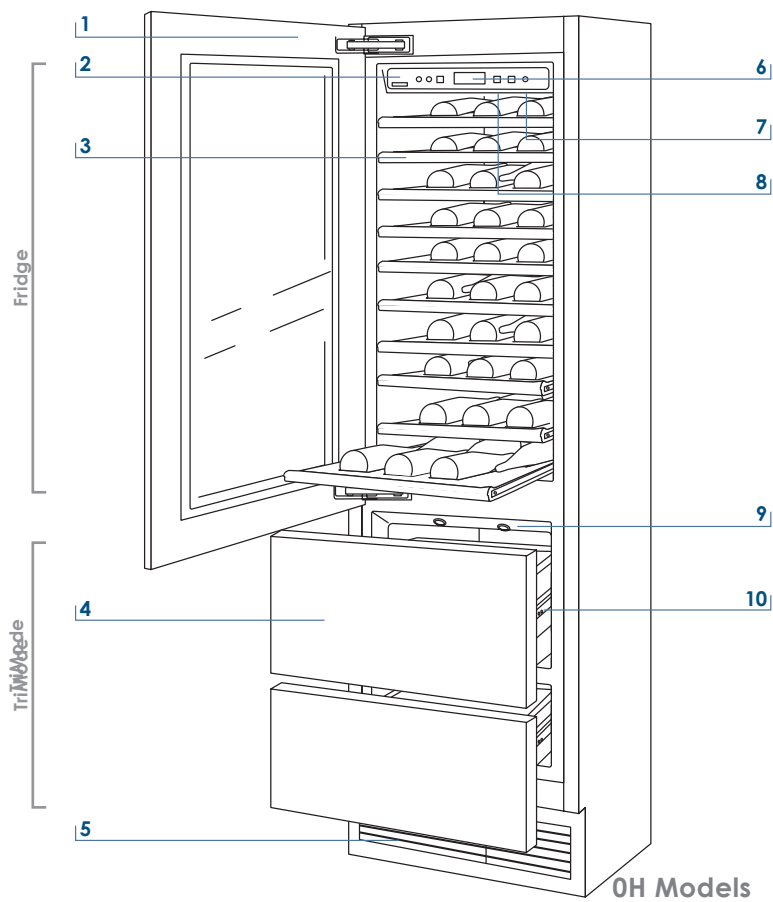

Two drawer Wine Cellar

- 1 Structure in stainless steel with aluminium trim
- 2 Wine Cellar and TriMode control panels with Menu
- 3 Sliding bottle shelves, mounted on wheels for easy extraction
- 4 TriMode drawers, may be used as freezer, refrigerator or cooler
- 5 Double refrigeration system
- 6 Temperature display
- 7 Acoustic signals
- 8 Vacation function (in Menu)
- 9 Innovative lighting
- 10 Automatic door and drawer closure

The innovative electronic control system designed by Fhiaba maintains constant temperature on the three compartments and visualizes it on the control panel display. It also allows user interaction making it possible to personalize settings of the various functions and to receive sound and/or visual messages should any malfunction occur in the appliance.



- | | | | |
|---|--|----------------------------|---|
| 1 | | Unit | Allows complete shutdown and start-up of the appliance (press for three seconds). |
| 2 | | Wine cellar | Allows switching on and off only the Wine Cellar compartment (press for three seconds). |
| 3 | | Menu | Allows access to the appliance functions menu. |
| 4 | | Up/down Wine Cellar | Using the Up and Down buttons, it is possible to change the set temperature of the refrigerator and scroll through the interactive menu. |
| 5 | | Display | Displays the temperature of the Wine Cellar and TriMode compartments, the date and time, Menu functions and visual messages. |
| 6 | | Up/Down (TriMode) | By selecting Up/Down the preset temperature can be changed according to the selected function mode (freezer, refrigerator, Crisper-Fresco). |
| 7 | | Enter | Confirms activation or deactivation of the selections made in the Menu. |
| 8 | | Alarm | Allows activating or deactivating the automatic ice production. |
| 9 | | Light | Allows illumination of the Wine Cellar and Cantina compartments also when the door is closed. Once activated, the light of the top compartment will automatically shut off after 6 hours. |



- | | | | |
|----|--|------------------------|--|
| 10 | | Display | Shows the temperature of the Cantina compartment. |
| 11 | | Up/Down Cantina | Using the Up and Down keys, it is possible to change the set temperature for the Cantina compartment. |
| 12 | | Cantina | Allows switching on and off only the Cantina compartment on or off (press for three seconds). |
| 13 | | Humidity | Allows adjustment of humidity in the Wine Cellar and Cantina compartments to three levels: High (HI), Medium (A) and Low (LO). |

4 Turning the appliance on and off

4.1 Turning on and off

First start-up When the appliance is connected to the electrical power supply but has not yet been turned on, the display shows the message

Stand by

This is a safety message to warn that power is supplied to the appliance, while all of the keys on the panel are off.

To switch on all the appliance compartments, press the Unit button  for three seconds.

Turning off the Wine Cellar compartment

Once you have turned on all of the compartments of the appliance, you can turn off only the wine cellar compartment by pressing the relevant key for three seconds.

The TriMode compartment is always on and cannot be turned off except by completely turning off the appliance.

Turning the Wine Cellar compartment on again

Press again for three seconds the relevant key.

Complete shutdown

To shut down the unit completely for cleaning or maintenance, press the Unit key  for three seconds.

Also take the plug out of the socket and turn off the omnipolar switch that powers it.

Lengthy shutdown periods

After you have completely shut down the appliance and unplugged it, empty it of all its contents, clean it and dry it. Leave the doors and the drawers ajar to prevent the formation of unpleasant odours.



To prevent accidental modification of settings, the keypad locks automatically after a certain period of time and the display shows the message "keypad locked". To re-activate it, simultaneously press the keys Menu and Up/Down (Down) for three seconds.

At the first start-up, if the message Standby does not appear, it means that the appliance has already started the cooling process. If this is the case, deactivate any possible acoustic signals by pressing the Alarm key , close the door and wait until the set temperature is reached.

During the first start-up, you will not be able to use the Menu to modify factory settings until the default temperature has been reached. It is however possible to set the time and date immediately; these parameters are required to activate some of the special functions.

If only the Cantina or Wine Cellar compartment is turned off, the corresponding fan will continue to run independently to prevent the formation of unpleasant odours and mould.

To adjust the temperature in the various compartments, use the up/down key \updownarrow for that compartment (see chapter 3.5).
If the "keypad locked" message appear, simultaneously press the keys Menu Ⓜ and Up/Down (Down) \updownarrow for 3 seconds.

Wines compartment

Each model has been carefully tested before leaving the factory and is adjusted so as to ensure high performance and low consumption. The ideal temperature for wine conservation does however depend on the types of wine you want to conserve, the method of conservation (Wine Cellar for conservation and consumption, or Cantina for the conservation and aging of prized bottles). It also varies according to personal taste. Please refer to the guide on wine conservation included further ahead in this manual.

As needed, you can reset the temperatures as follows:

- Cantina Compartment:
from +4° C to +18° C (from 39.2° F to 64.4° F).
The default temperature is +12° C (53.6° F).
- Wine Cellar compartment:
from +4° C to +18° C (from 39.2° F to 64.4° F).
The default temperature is +10° C (50° F).



If the "keypad locked" message appear, simultaneously press the keys Menu Ⓜ and Up/Down (Down) \updownarrow for 3 seconds.



The displayed temperature may vary slightly with respect to the set temperature if the doors are continuously opened or insertion of room temperature food or large quantities of food.

It takes 6 to 12 hours to reach the selected temperature.

TriMode compartment

The TriMode compartment is default set to freezer mode but it can also be set to run as a refrigerator or cooler compartment. Instructions for conversion are provided in the paragraph on special functions and settings.

As needed, you can reset the temperatures as follows:

- Freezer compartment: from -15° C to -22° C (from 5° F to -7.6° F).
The default temperature, which is recommended, is -18° C (0° F)
- Refrigerator compartment: from +2° C to +8° C (from 35.6° F to 46.4° F).
The default temperature, which is recommended, is +5° C (41° F).
- Cooler compartment: from -2° C to +2° C (from 28.4° F to 35.6° F).
The default temperature, which is recommended, is 0° C (32° F).

An integrated control system provides information through luminous signals or text messages shown on the display. The information signal is always displayed with a fixed text message, while a malfunction signal is shown with blinking text. The acoustic signal that accompanies some malfunction signals can be deactivated by pressing the Alarm key Ⓜ on the main control panel. The list of malfunction signals is located in the back of this manual.

5 Settings and Special Functions

5.1 Customization and Language Settings



To prevent accidental modification of settings, the keypad locks automatically after a certain period of time and the display shows the message "keypad locked". To re-activate it, simultaneously press the keys Menu \blacktriangle and Up/Down (Down) ∇ for at least three seconds.



It is possible to customized the functions of your Fhiaba to adapt it to diverse usage needs, resetting the main parameters (Settings) or activating special functions (Functions).

Functions are visualized on the main display by pressing the Menu button \blacktriangle .

The Up/Down buttons \updownarrow permit scrolling the available functions, which can be selected by pressing the Enter button \checkmark . The display visualizes the current functioning status.

Using the Up/Down buttons \updownarrow , it is also possible to scroll through the selected function, activating or deactivating by pressing the Enter button \checkmark .

Once the function is confirmed, the display will automatically visualize the main menu to select other functions.

At any time it is possible to return to the previous selection through the Menu button \blacktriangle .

The language of the messages appearing on the display can be changed by operating as follows:

Enter the Menu by pressing the Menu button \blacktriangle select Settings via the Up/Down buttons \updownarrow and confirm via Enter \checkmark .

Then select the Language function and the desired language.

5.2 Special functions activated through the Menu

To use special functions, select the Menu key \blacktriangle and use the Up/Down key \updownarrow to access the menu, confirming the selection Functions.

Dual Zone

This function can be activated only on models featuring a wine cellar without internal separator. It allows to differentiate the temperature in the upper part of the cellar (warmer and therefore better suited to keep red wines) from the temperature in the lower part (colder and therefore better suited to keep white wines).

How to activate Functions \rightarrow \checkmark \rightarrow \updownarrow Dual Zone \rightarrow \checkmark \rightarrow \updownarrow Dual Zone On \rightarrow \checkmark

How to deactivate Functions \rightarrow \checkmark \rightarrow \updownarrow Dual Zone \rightarrow \checkmark \rightarrow \updownarrow Dual Zone Off \rightarrow \checkmark

Shopping TriMode

This function must be activated at least 24 hours before inserting room temperature items into the freezer, or several hours before placing into the freezer previously frozen items which have been subject to a slight temperature rise. This function is automatically deactivated when the programmed time period expires.

It is possible o program timed activation of the function.

After a prolonged interruption of the electrical power, it is necessary to reactivate the function.

How to activate Functions \rightarrow \checkmark \rightarrow \updownarrow Shopping TriMode \rightarrow \checkmark \rightarrow \updownarrow ShoppingTriMode ON/OFF \rightarrow \checkmark \rightarrow \updownarrow Shopping TriMode On \rightarrow \checkmark

How to deactivate Functions \rightarrow \checkmark \rightarrow \updownarrow Shopping Frigde \rightarrow \checkmark \rightarrow \updownarrow ShoppingTriMode ON/OFF \rightarrow \checkmark \rightarrow \updownarrow Shopping TriMode Off \rightarrow \checkmark

How to program timed activation Functions \rightarrow \checkmark \rightarrow \updownarrow Shopping TriMode \rightarrow \checkmark \rightarrow \updownarrow Shopping Time \rightarrow \checkmark \rightarrow \updownarrow Set Hours: 1 \rightarrow \checkmark

Vacation TriMode This function (recommended in case of prolonged absences since it allows considerable energy savings) brings the Tri-Mode compartment temperature to - 18°C (46.4°F). It is possible to program the duration, or it can be manually deactivated upon re-entry after a period of absence. This function remains active even if during the period of absence there is a prolonged interruption of electrical power.

- How to activate** Functions → (✓) → (∧) Vacation TriMode → (✓) → (∧)
 Vacation ON/OFF → (✓) → (∧) Vacation TriMode On → (✓)
- How to deactivate upon re-entry** Functions → (✓) → (∧) Vacation TriMode → (✓) → (∧)
 Vacation ON/OFF → (✓) → (∧) Vacation TriMode OFF → (✓)
- How to program the duration** Functions → (✓) → (∧) Vacation TriMode → (✓) → (∧)
 Vacation Time → (✓) → (∧) Set Days: 1 → (✓)

It is possible to program a period from 1 to 90 days.

Bottle Cooler This function can be activated when it is necessary to cool off beverages quickly, by placing them inside the freezer compartment. It is possible to select a duration of 1 to 45 minutes. A sound signal will indicated when the optimal temperature has been reached. After removing the beverages, deactivate the sound signal by pressing the Alarm button (⊗).



- How to activate** Functions → (✓) → (∧) Bottle Cooler → (✓) → (∧)
 Bottle Cooler ON/OFF → (✓) → (∧) Bottle Cooler On → (✓)
- How to deactivate** Functions → (✓) → (∧) Bottle Cooler → (✓) → (∧)
 Bottle Cooler ON/OFF → (✓) → (∧) Bottle Cooler Off → (✓)
- How to program the duration** Functions → (✓) → (∧) Bottle Cooler
 Set Cooling Time → (✓) Set time : 20 min → (∧) → (✓)

Sabbath Mode (Optional) The function makes it possible to comply to certain religious observances requiring that the operation of the appliance is not affected by the opening or closing of the doors (the thermostatic control, the inner lighting and the ice maker are deactivated).

- How to activate** Functions → (✓) → (∧) Sabbath Mode → (✓) → (∧)
 Sabbath Mode ON/OFF → (✓) → (∧) Sabbath Mode On → (✓)
- How to deactivate** Functions → (✓) → (∧) Sabbath Mode → (✓) → (∧)
 Sabbath Mode ON/OFF → (✓) → (∧) Sabbath Mode Off → (✓)

5 Settings and Special Functions







5.3 Basic settings of the Menu







Select the Menu button  and used the Up/Down button  to select **Settings**.







TriMode Options

The freezer compartment can, if required, be converted to the refrigeration or Crisper-Fresco operating mode.

- How to set the Fridge function**

Settings →  →  TriMode Options →  → 
 Fridge →  Enter to confirm → 
- How to set the Crisper-Fresco function**





Settings →  →  TriMode Options →  → 
 Fresco →  Enter to confirm → 
- How to revert to the Freezer function**

Settings →  →  TriMode Options →  → 
 Freezer →  Enter to confirm → 

Default Setting

This offers the possibility to reset default factory settings and cancels any previous changes.

- How to reset default settings**



Settings →  →  Default Setting → 
 Enter to confirm → 



ATTENTION: If the default settings are restored, it is necessary to reactivate the choice of operation of the TriMode compartment in case it was previously set as Fridge or Fresco.

Date

Set Date

The display will visualize the date in the format dd:mm:yy (day:month:year), the day will blink. Use the Up/Down buttons  to modify the setting, confirm with Enter  to go on to the next setting; once the year is confirmed the date will be set.







- How to set the date**







Settings →  →  Date →  →  Set Date
 →  DATE: 01-01-2009 → 

Show Date

Using this function it is possible to deactivate/activate the date visualization on the display.

- How to activate the date**

Settings →  →  Date →  →  Show Date
 →  →  DATE: 01-01-2009 On → 
- How to deactivate the date**

Settings →  →  Date →  →  Show Date
 →  →  DATE: 01-01-2009 OFF → 

Time

Set Time

The display visualizes the hours and minutes in the format hh:mm and with hh: blinking. Use the Up/Down buttons \updownarrow to modify the setting and then confirm by pressing Enter \checkmark to go on to the next setting. Once the minutes are confirmed, the time will be set.

How to set the time Settings \rightarrow \checkmark \rightarrow \updownarrow Time \rightarrow \checkmark \rightarrow \updownarrow Set Time
 \rightarrow \checkmark TIME: 01:01 \rightarrow \checkmark

Set 12/24

This function selects the display at 12 or 24 h.

How to set the display to 12 h Settings \rightarrow \checkmark \rightarrow \updownarrow Time \rightarrow \checkmark \rightarrow \updownarrow Set View \rightarrow \checkmark \rightarrow \updownarrow
 Set:12 \rightarrow \checkmark \rightarrow \updownarrow

How to set the display to 24 h Settings \rightarrow \checkmark \rightarrow \updownarrow Time \rightarrow \checkmark \rightarrow \updownarrow Set View \rightarrow \checkmark \rightarrow \updownarrow
 Set:24 \rightarrow \checkmark \rightarrow \updownarrow

Show Time

Through this function it is possible to activate/deactivate the constant visualization of the time.

How to activate the permanent time Settings \rightarrow \checkmark \rightarrow \updownarrow Time \rightarrow \checkmark \rightarrow \updownarrow Show Time
 \rightarrow \checkmark \rightarrow \updownarrow TIME: 01:01 On \rightarrow \checkmark

How to deactivate Settings \rightarrow \checkmark \rightarrow \updownarrow Time \rightarrow \checkmark \rightarrow \updownarrow Show Time
 \rightarrow \checkmark \rightarrow \updownarrow TIME: 01:01 OFF \rightarrow \checkmark

5 Settings and Special Functions

Language The function allows selection of the language for the display messages.

- Italian Settings → ✓ → ^ Language → ✓ → ^ italiano → ✓
- English Settings → ✓ → ^ Language → ✓ → ^ english → ✓
- French Settings → ✓ → ^ Language → ✓ → ^ français → ✓
- German Settings → ✓ → ^ Language → ✓ → ^ deutsch → ✓
- Spanish Settings → ✓ → ^ Language → ✓ → ^ español → ✓

Set °C/°F This function permits visualizing the temperature in Centigrade or Fahrenheit degrees. Normally, the appliance is set for visualization in centigrade degrees.

- How to set the temperature in Centigrade Settings → ✓ → ^ Set 'C/'F → ✓ → ^ Set 'C → ✓
- How to set the temperature in Fahrenheit Settings → ✓ → ^ Set 'C/'F → ✓ → ^ Set 'F → ✓

Wine shelf

The shelves can be easily removed for cleaning. Remove the bottles, completely extract the shelf, tilt it upward until the wheels are free of their seat and extract it.

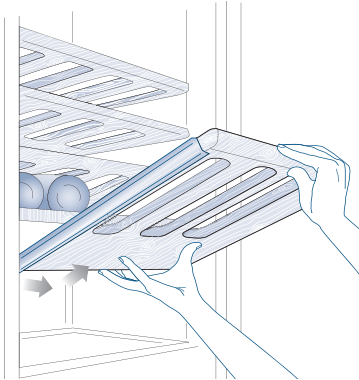
**TriMode drawer**

Fixed to the slide guides with two locking nuts

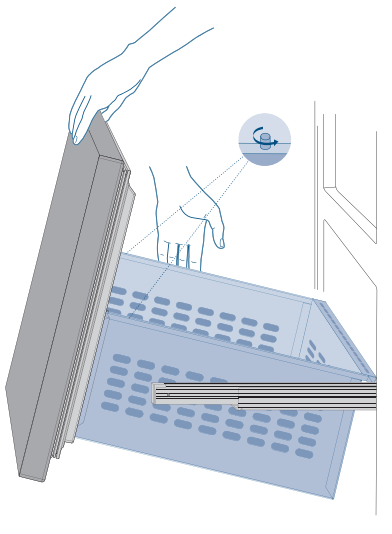

- to remove the drawer, unscrew the locking nuts and remove the drawer.

- to remove the inner TriMode drawer unscrew the locking nuts.

7 Lighting

7.1 Lighting

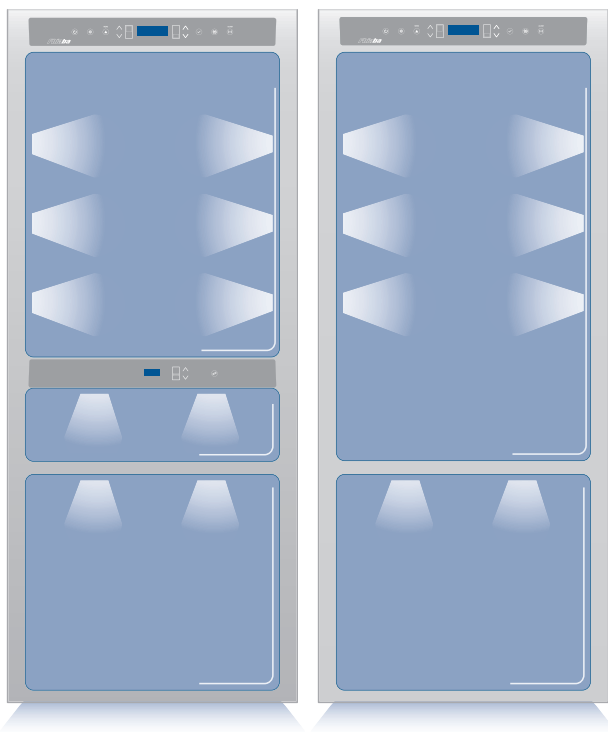

To provide optimum interior lighting, LED strips illuminate the refrigerator compartment from the top and sets of LED lights directly illuminate different areas of the refrigerator compartment, of the Crisper-Fresco drawers and the freezer drawer.

In case of malfunction and/or failure of the lighting system, you should contact an authorized Fhiaba Service Agent.



Once activated, the light of the top compartment will automatically shut off after 6 hours.

The TriMode compartment, used in conjunction with the Wine Cellar and Cantina compartment, allows great flexibility in the use of the appliance.

Some possible uses:

Freezer mode

- Liquors, such as vodka, gin, tequila, schnapps, limoncello and the glasses to serve them
- Rapid cooling of beverages, by activating the bottle cooler function
- Storage of large amounts of ice.

Refrigerator mode

- As expansion of the Wine Cellar or of the Cantina
- For refrigeration of beer and soft drinks
- For storage of cold dishes and snacks.

Cooler mode

- For conservation of ham, salmon
- gourmet preparations.

It comes without saying that, the compartment can be used in a traditional manner. Suggestions and instructions are provided to offer you best conservation of your food over time in complete safety.

To fully use the capacity of the TriMode compartment:

- remove the drawer
- remove the top drawer
- install the supports delivered with the units (on request)

9 Conservation of wines

9.1 General directions

As is known, wine can be stored for long periods of time if this is done under the following conditions:

- Suitable temperature without appreciable variations over time
- Controlled level of humidity
- Protection from light
- Absence of noise and vibrations
- Absence of odours
- Bottle kept horizontal.

All of these conditions are fully met in the Fhiaba Wine Cellar.

9.2 Conservation temperature

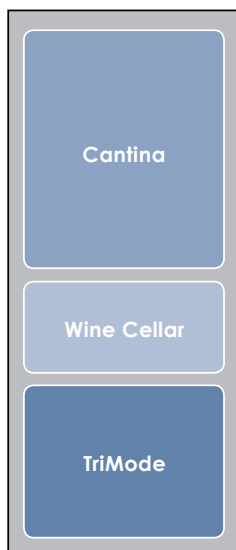

Models with Cantina and Wine Cellar

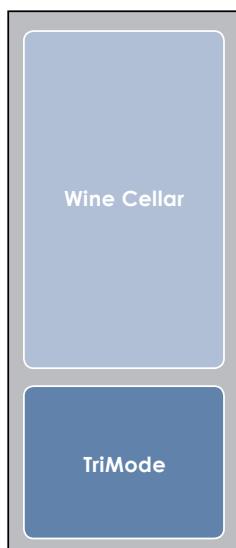

Models with Wine Cellar

The space offered by the Wine Cellar and Cantina compartments, which can be expanded as necessary by using the TriMode compartment as a wine cellar, allows conservation of your best wines at three different temperatures.

The three compartments are initially set to the following temperatures:

- **Cantina compartment**
+12° C (53.6° F) - adjustable from +4° C to +18° C (from 39.2° F to 64.4° F)
- **Wine Cellar compartment**
+10° C (50° F) - adjustable from +4° C to +18° C (from 39.2° F to 64.4° F)
- **TriMode drawer**
-18° (0° F) - adjustable from -15° C to -22° C (from 5° F to -7.6° F)
(freezer mode)

To transform the TriMode compartment into a wine cellar space, you must access the Menu, set it as a refrigerator compartment, and adjust it to a temperature between +4° C and +8° C (from 39.2° F to 46.4° F).

All the temperatures can be modified according to the characteristics of the wines and personal preferences. However, you should attempt to keep the temperature as constant as possible over time.

Rapid and large-scale temperature variations can in fact cause dilation of the liquid and early aging of the wine.

You should also avoid very low temperatures (below 4° C - 39.2° F) which may lead to the formation of deposits and damage the aesthetic qualities of the wine.

All the compartments offer optimal conditions and take into account all these needs. It should however be noted that the Cantina compartment, in particular, is thermostatically controlled in a very precise manner and ensures the utmost care and attention over time of your most prized bottles.

Time of conservation 9.3

Improvement of wine over time and its duration usually depends on the character of the variety and its type.

The following chart shows the best period of conservation and aging for various types in ideal conservation conditions offered by your appliance. However, you should always follow the instructions of the winemaker, especially for fine wines.

TYPE OF WINE	CONSERVATION TEMPERATURE	TIME OF CONSERVATION
New wines (Vin Nouveau)	from 12° to 14° C	6 months
Sweet sparkling wines	from 8° to 10° C	1 year
Rosé	from 10° to 14° C	1 year
Semi-sparkling wines	from 10° to 12° C	1 - 2 years
Normal white wines	from 10° to 14° C	1 - 2 years
Light red wines	from 12° to 14° C	2 years
Dry sparkling wines	from 8° to 10° C	2 years
Classic sparkling wines	from 8° to 10° C	3 - 4 years
Barrique and Vigorous white wines	from 8° to 12° C	3 - 5 years
Normal red wines	from 14° to 16° C	3 - 5 years
Barrique and Vigorous red wines	from 14° to 18° C	7 - 10 years
Straw wines or Liqueurous wines	from 16° to 18° C	10 - 15 years

Consumption temperature 9.4

As a general rule, white wines should be served at a temperature between 10 and 12° C (50 and 53,6°F) and red wines between 12 and 14° C (53,6 and 57,2°F).

Some wines may however be best enjoyed at higher or lower temperatures.

You should also keep in mind that, during the summer, wine is generally enjoyed at lower temperatures than during the winter.

You should also consider the following:

White wines

White wines are normally not served at high temperatures, since they are generally more acidic than red wines and not very tannic. Therefore they are more enjoyable at low temperatures.

It is preferable to serve these wines between 10° C and 14° C (50°F and 57,2°F). Young, fresh and aromatic wines can also be served at 10° C (50°F), while less aromatic ones are served at 12° C (53,6°F).

Temperatures between 12° C and 14° C (53,6°F and 57,2°F) are for soft, mature white wines that have been aged for some years in the bottle.

Higher temperatures would favour the exaltation of the sweet character of the wine, at the expense of the acidity and flavour, which are considered pleasant and desirable characteristics of this type of wine.

Rosé

Rosé wine is served at the same temperature as white wines. It should be noted that these wines may include a certain amount of tannin and may therefore be preferable at higher temperatures. Therefore, they are served between 10° C and 12° C (50°F and 53,6°F), if young and fresh, and between 12° C and 14° C (53,6°F and 57,2°F) if robust and mature.

9 Conservation of wines

New wines (Vin Nouveau) Due to the special processing they undergo, new vintage wines contain a low tannin content and are therefore more enjoyable if served between 12° C and 14° C (53,6 and 57,2°F).

Red wines Since they contain more tannin and are less acidic, red wines are normally served at higher temperatures. Younger wines with less tannin are normally served between 14° C and 16° C (57,2 and 60,8°F), while more full-bodied ones that are more tannic may be served at up to 18° C (64,4°F). Some wines that have aged for years in the bottle, still full-bodied and tannic, may be served at 18°C (64,4°F) or even 20° C (68°F). Young red wines with little tannin and slightly structured may be enjoyable at lower temperatures, between 12° C and 14° C (53,6 and 57,2°F).

Sparkling wines It is difficult to provide instructions to cover the wide variety of sparkling wines in available. As a general rule, sweeter and more aromatic sparkling wines should be served at lower temperatures, down to 8° C (46,4°F), whereas more tannic sparkling wines may be served at higher temperatures, up to 14° C (57,2°F). Dry sparkling wines are usually served between 8° C and 10° C (46,4 and 50°F). "Classic" sparkling wines are normally served at these temperatures, which may be as high as 12° C (53,6°F) for sparkling wines that have been aged for some time. It is however advisable, especially for finer wines, to follow the suggestions and recommendations of the winemaker on the bottle.

Liqueur and straw wines These types of wines can be served at temperatures between 16° C and 18° C (60,8 and 64,4°F), depending on personal tastes, to attenuate the sweet taste of straw wines, it can also be served at 10° C (50°F).

9.5 Position of bottles

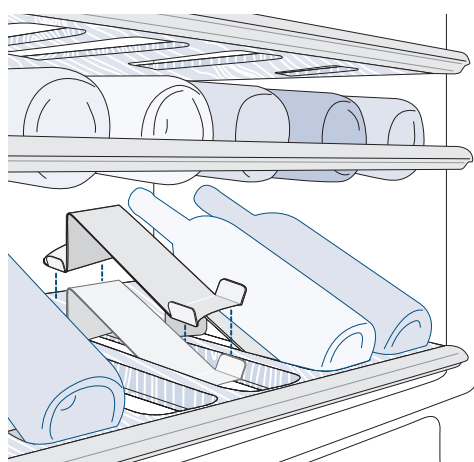

The sliding shelves are made of fine wood and contoured so as to hold bottles of the most classical traditional shape or of the most modern design.

Whether your collection holds fine bouteilles or petit bouteilles, they will be right at home in the Fhiaba Wine Cellar. A special accessory, available on request, will let you place them in an inclined position, in order to display the labels of your most prized items.

Also Magnum bouteilles can be stored, provided you remove the shelf just above the one that will hold them.

If the TriMode compartment is also used as a wine cellar, the bottles may be kept in a horizontal position, as long as they do not move or touch one another. A special accessory for this purpose may be provided on request.

Recommendations for conserving fresh food 10.1

Vegetables

Wash vegetables in cold water and dry well. Place vegetables in vacuum packed containers, plastic containers or vegetable bags.



Fruit

Wash and dry fresh fruit. Pack very aromatic fruit in plastic bags. Fruit should be placed in the Cooler compartment on low humidity.



Packaged meat

Place in the refrigerator in its original packaging. After opening, wrap the remaining food in plastic bags or aluminium foil.



Fresh meat, fish and poultry

Remove the original packaging, then place in plastic bags or containers and immediately place back in the refrigerator.



Eggs

Place the eggs in their package or container into the refrigerator without washing them. Check the expiration date and use the eggs within two weeks of purchasing.



Milk, cream and fresh cheeses

These should be kept in their original closed packaging. Place these on refrigerator shelves and consume them within five days of purchase.



Cheeses

Place these in the refrigerator in their original packaging. Once opened, close them hermetically in plastic bags or aluminium foil.

Leftovers

Let these cool off and cover hermetically with aluminium foil or place in sealed containers to prevent drying and release of odours.

Recommendations for conserving frozen food 10.2



Frozen foods

Place foods in plastic bags for the freezer. These bags must be hermetically sealed against air and humidity. Do not refreeze defrosted meat.



After a prolonged power outage, when the power comes back on, a sound signal will let you know that the temperature is above what is best suited for conservation.

These temperatures are shown for one minute on the display. This makes it possible for the user to decide how best to use the conserved foods.

After one minute, the displays will start working normally again, while the Alarm key (🔊) will continue to flash. Touch the Alarm key (🔊) to again view the highest recorded temperatures.

11 Recommended times for food conservation

Fresh foods	Conservation area	Time
Raw meats		
Large cuts	Cooler Compartment	4 days
Steaks, poultry and wild game	Cooler Compartment	3 days
Ground meat	Cooler Compartment	1-2 days
Carpaccio	Cooler Compartment	Immediately
Cooked meat		
Boiled meat and roasted meat	Refrigerator Compartment	2 days
Meat sauce	Refrigerator Compartment	6 days
Raw and cooked fish	Cooler Compartment	2 days
Soups and broths	Refrigerator Compartment	2 days
Pasta	Refrigerator Compartment	2 days
Opened cold cuts	Refrigerator Compartment	3 days
Fresh cheeses	Refrigerator Compartment	2-3 days
Well protected aged cheeses	Refrigerator Compartment	Several months
Eggs (fresh and unwashed)	Refrigerator Compartment	15 days
Opened containers	Refrigerator Compartment	2-3 days
Raw vegetables (in perforated bags)	Refrigerator Compartment	3-6 days

Frozen foods	Conservation area	Time
Beef, veal, lamb and goat	Freezer Compartment	(steaks) 6-12 months
Beef, veal, lamb and goat	Freezer Compartment	(Meat with bone) 4-6 months
Ground beef	Freezer Compartment	1-2 months
Pork	Freezer Compartment	(Without bone) 4-6 months
Pork	Freezer Compartment	(With bone) 2-3 months
Ground pork	Freezer Compartment	1-2 months
Meat leftovers	Freezer Compartment	2-3 months
Whole chicken and turkey	Freezer Compartment	8-12 months
Goose, duck and pheasant	Freezer Compartment	4-8 months
Fish	Freezer Compartment	1-2 months
Crustaceans	Freezer Compartment	2-3 months
Cooked foods	Freezer Compartment	1-2 months
Vegetables	Freezer Compartment	8-12 months
Fruit	Freezer Compartment	6-12 months
Desserts and cakes	Freezer Compartment	2-3 months

Care and Cleaning 12.1



Scrupulously follow the detailed directions that can be found in the provided kit and never use abrasive or metallic products which could scratch and damage the satin finishing on the appliance permanently.

Before performing any sort of cleaning, disconnect the appliance from the electrical power supply. Make sure you do not damage the refrigerant circuit in any way.

To clean the parts in steel use a microfiber cloth and the sponge provided in the kit with the appliance.

Always use the cloth and sponge in the direction of the steel's satin finish.

Every now and then, to make to steel shiny, wipe with a slightly damp microfiber cloth.

Do not use the sponge on aluminium parts, such as the handles and the profiles of the glass shelves.

You should use special care to keep free of obstructions the ventilation openings in the appliance or in the cabinet that houses it.

Condenser cleaning 11.2

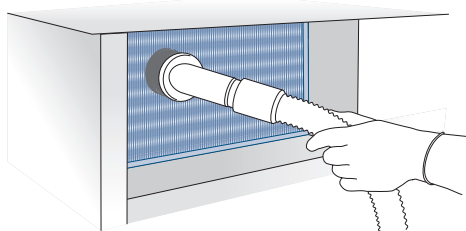
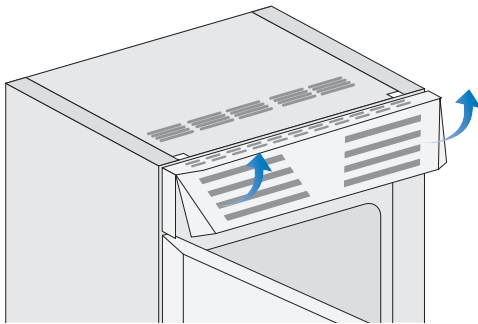

A ventilation grille is located either at the top of the appliance or at the bottom according to the model type.

A foam filter is placed behind the grille to protect from dust the ventilation system.

To clean it use a vacuum cleaner with a soft brush attachment at maximum power, sweeping it along the vent slits. In case of a significant dust build up, the ventilation grille can be removed to allow a more accurate cleaning of the filter.

Take care also to check the condition of the finned condenser and clean it from dust if needed.

Operate as follows:

- Switch off the appliance by pressing the Unit button @ on the main control panel for approx 3 seconds.
- On models with ventilation at the base remove the grille at the bottom and take it off. On models with ventilation at the top the grille (magnetically attached) lift as shown in the picture.
- Thoroughly clean the grille and the foam filter, by means of a vacuum cleaner and the soft brush attachment.
- Wait approx 30 minutes, until the finned condenser cools down to room temperature, then clean it thoroughly from any dust build up as shown in the picture, taking care not to damage it.
- Start up the appliance again, by pressing the Unit button @ on the main control panel for approx 3 seconds.



The edges of the condenser are sharp, therefore use adequate protection for the hands and arms when cleaning the condenser.

Internal cleaning 12.3



Do not use water on the electrical parts, lights and control panel.



Do not bring cold glass parts into contact with boiling water.

Do not wash any parts of the refrigerator in a dishwashing machine since this could damage or irreparably deform the parts.

Clean the internal and removable parts by washing them with a solution of lukewarm water, a small amount of dishwashing detergent.

Rinse and dry right away.

Do not use mechanical devices or other methods to speed up defrosting.

13 Troubleshooting guide

13.1 Troubleshooting guide

If you notice malfunctions in your appliance, use this guide before calling Service. This guide may help you resolve the problem yourself or could provide important information to ensure rapid and effective service.

Malfunction message	A malfunction is usually indicated on the display. Problems that cannot be resolved by the user are signalled through a malfunction code.
The appliance does not work	Is the appliance connected to the electrical power supply? Does electrical power arrive at the electrical socket? Is the Unit key  activated? Is the condenser clean?
The internal temperatures are higher than normal	Does the display show a malfunction code? Is the temperature adjusted correctly? Is the condenser clean? Were the doors or drawers open for a long period of time? Were large quantities of food recently inserted?
The appliance remains in function for a long time period	Bear in mind that during a very hot weather and with very high temperatures in the room it is normal that the compressor remains in operation for prolonged periods of time. Were the doors or drawers open for a long period of time? Were large quantities of food recently inserted? Is the condenser clean? Check that the doors are closed and that the food or containers do not obstruct the perfect closure of the door.
If you hear strange noises	It is normal to hear noise from the fans or compressors during the defrost phase. Noise could be louder depending on the position of the appliance and the surrounding environment.
Condensation forms both inside and out	If the climate is very humid, the formation of condensation is normal. Opening the door or drawers for prolonged periods of time can contribute to the formation of condensation. In any case, make sure that the doors are always perfectly closed.
The Refrigerator or Freezer has frost or ice	Did you leave the doors open for a long period of time? Do the doors close perfectly? If the doors do not close perfectly, contact your installer.
Unpleasant odours inside the refrigerator	Clean the appliance completely as indicated in this manual. Hermetically cover all the food. Do not conserve food for prolonged periods of time.
The doors are difficult to open	The appliance was designed to permit hermetic closure. When the door is closed, a vacuum situation can occur: in this case it is necessary to wait a few seconds until the pressure balances before opening the door.

Display message	Malfunction description
Power Failure	Prolonged interruption of electrical power The appliance starts up again automatically and indicates the highest recorded temperatures
Door open	Door open this message appears few minutes from the door opening
Drawer open	Drawer open this message appears few minutes from the drawer opening
Cellar too warm	Cellar (Wine Cellar) compartment too warm See the troubleshooting guide
Cellar too cold	Cellar (Wine Cellar) compartment too cold Wait 12 hours. If the problem persists, contact Customer Care
Cantina too warm	Cantina compartment too warm See the troubleshooting guide
Cantina too cold	Cantina compartment too warm Wait 12 hours. If the problem persists, contact Customer Care
Fridge too warm	TriMode compartment (refrigerator mode) too warm See the troubleshooting guide
Fridge too cold	TriMode compartment (refrigerator mode) too cold Wait 12 hours. If the problem persists, contact Customer Care
Cooler too warm	TriMode compartment (cooler mode) too warm See the troubleshooting guide
Cooler too cold	TriMode compartment (cooler mode) too cold Wait 12 hours. If the problem persists, contact Customer Care
Freezer too warm	TriMode compartment (freezer mode) too warm See the troubleshooting guide
Freezer too cold	TriMode compartment (freezer mode) too cold Wait 12 hours. If the problem persists, contact Customer Care
Error Code...	Functional problems call Customer Care who may help you to solve the problem or put you in contact with the nearest Service Agent

14 Prior to calling Service

14.1 Prior to calling Service

If our recommendations were not sufficient to solve the problem, please get in touch with our **Customer Care Center** for further support via our website at

www.fhiaba.com

or by sending an email to

care@fhiaba.com

You can also contact us on the phone at

+39 0434 420 160

If necessary, we will place you in contact with the Fhiaba Service Center nearest to you.

Before calling, write down the model type and serial number and any messages which may have appeared on the display.

This information is available on the warranty certificate and on the rating plate which is located on the cabinet's frame, on the bottom left side, behind the bottom drawer.

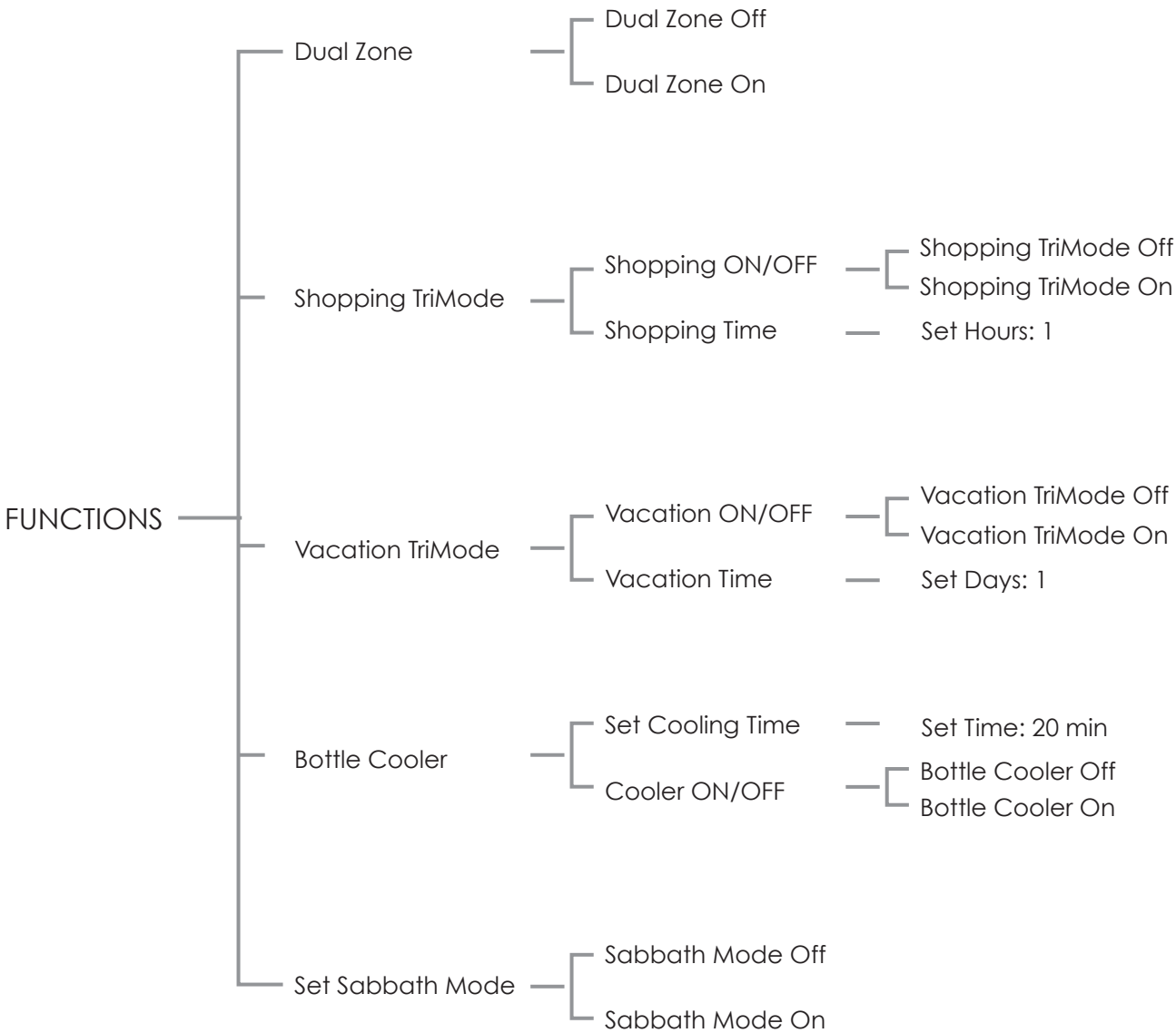

15 Menu Map

15.2 Settings

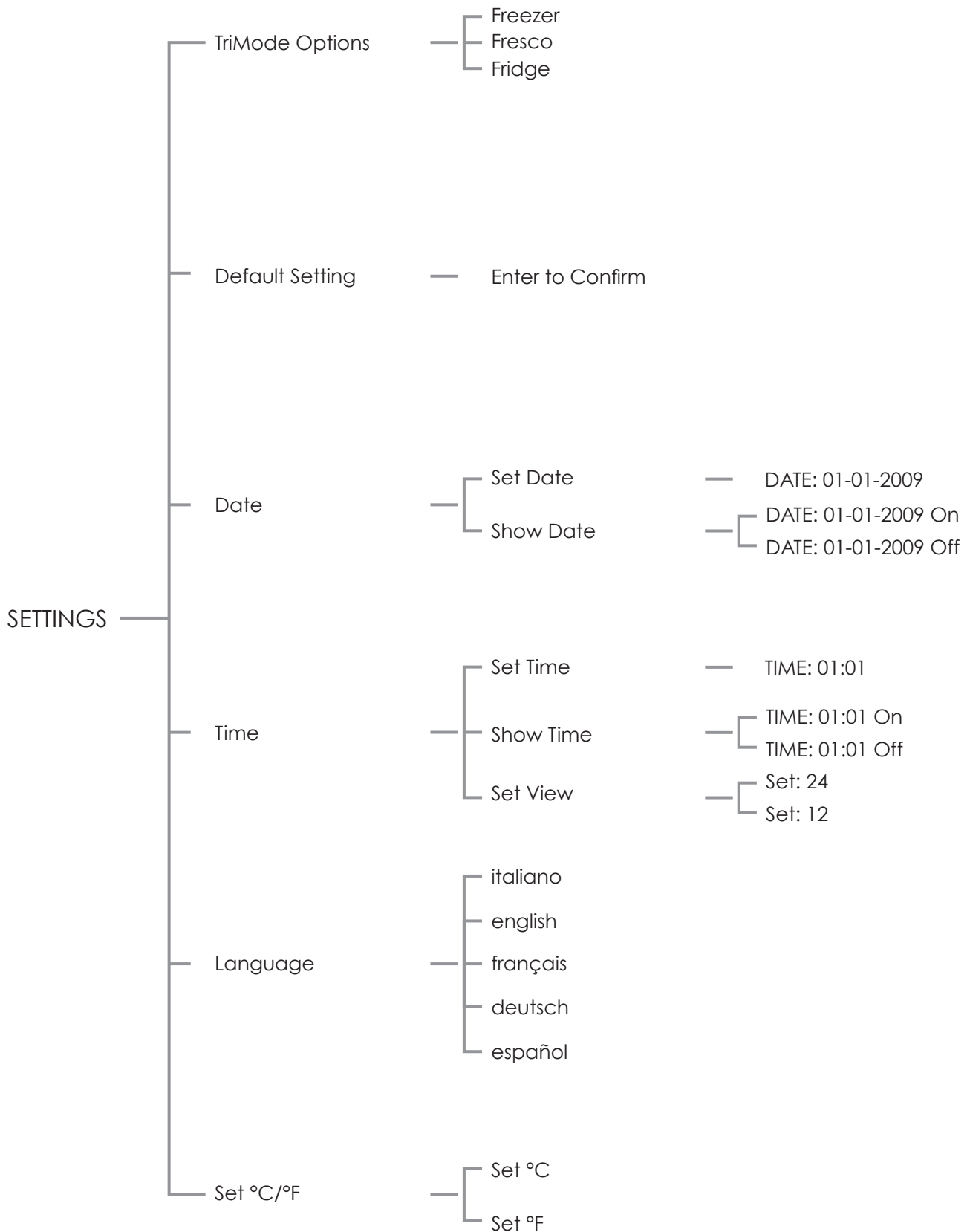

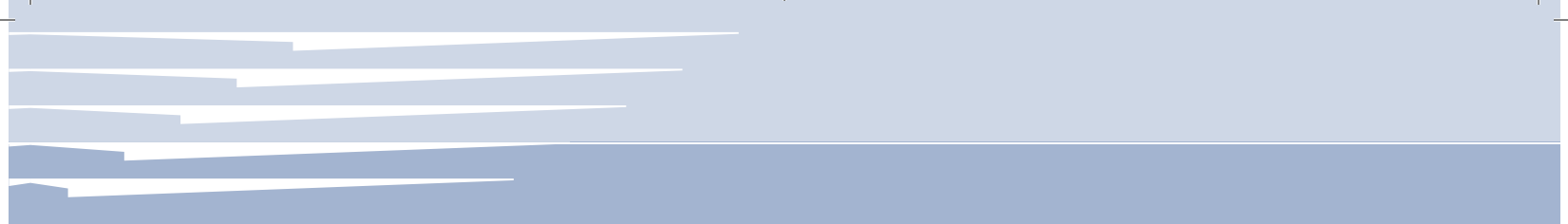

11-11-2014

Fhiaba srl Via Fiumicino, 20 · 33082 · Azzano Decimo · PN · Italy · Tel +39 0434 420160 · Fax +39 0434 420161
E-mail: info@fhiaba.com · www.fhiaba.com · Info Line 800-Fhiaba (800-344222)

Fhiaba srl is constantly researching new way to improve the features and the design of their products, therefore models are often upgraded and reviewed.



www.fhiaba.com

Info Line

800 - Fhiaba · (800-344222)