

**GARMIN®**

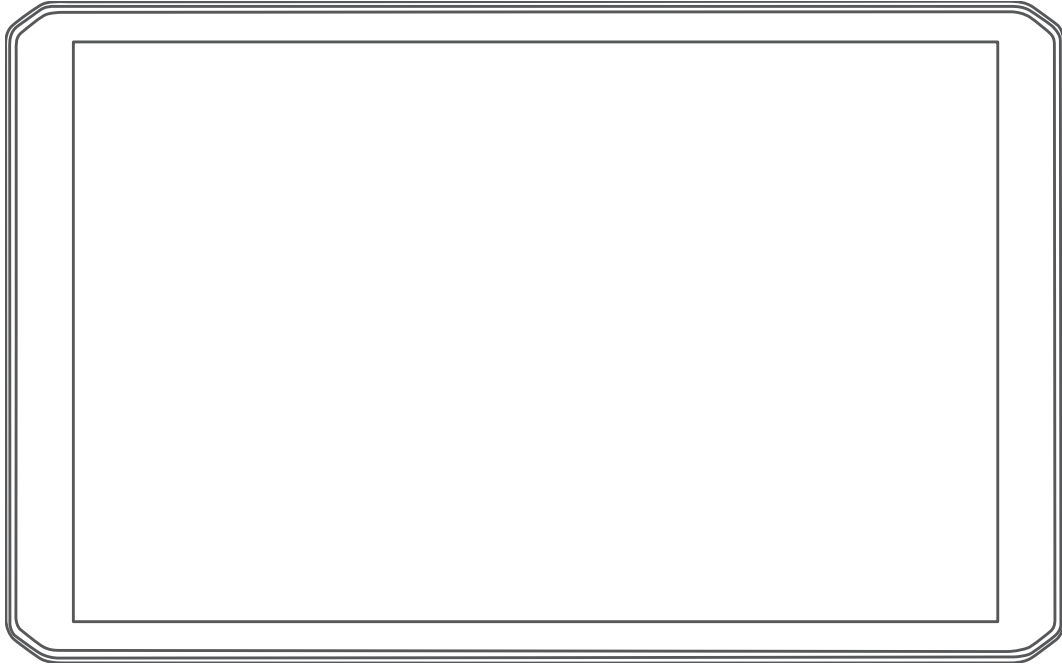

**RV 890 / CAMPER 890 / RV 1090 /  
CAMPER 1090**

---

**Owner's Manual**

© 2020 Garmin Ltd. or its subsidiaries

All rights reserved. Under the copyright laws, this manual may not be copied, in whole or in part, without the written consent of Garmin. Garmin reserves the right to change or improve its products and to make changes in the content of this manual without obligation to notify any person or organization of such changes or improvements. Go to [www.garmin.com](http://www.garmin.com) for current updates and supplemental information concerning the use of this product.

Garmin® and the Garmin logo are trademarks of Garmin Ltd. or its subsidiaries, registered in the USA and other countries. These trademarks may not be used without the express permission of Garmin.

BC™, Fusion®, Fusion-Link™, Garmin Drive™, Garmin Express™, Garmin PowerSwitch™, and myTrends™ are trademarks of Garmin Ltd. or its subsidiaries. These trademarks may not be used without the express permission of Garmin.

Android™ is a trademark of Google Inc. Apple® and Mac® are trademarks of Apple Inc, registered in the U.S. and other countries. The BLUETOOTH® word mark and logos are owned by the Bluetooth SIG, Inc., and any use of such word mark or logo by Garmin is under license. Foursquare® is a trademark of Foursquare Labs, Inc. in the U.S. and in other countries. HISTORY® and the H logo are trademarks of A+E Networks and are protected in the United States and other countries around the globe. All Rights Reserved. Used with Permission. microSD® and the microSDHC logo are trademarks of SD-3C, LLC. TripAdvisor® is a registered trademark of TripAdvisor LLC. Ultimate Campgrounds is a trademark of The Ultimate Public Campground Project. Windows® is a registered trademark of Microsoft Corporation in the United States and other countries. Wi-Fi® and Wi-Fi CERTIFIED MiraCast™ are registered marks of Wi-Fi Alliance Corporation.

# Table of Contents

<b>Getting Started.....</b>	<b>1</b>	Shaping Your Route.....	15
Device Overview.....	2	Taking a Detour.....	16
Mounting and Powering the Device in Your Vehicle.....	3	Changing the Route Calculation Mode.....	16
Installing the Screw-Down Mount on the Dashboard.....	5	Stopping the Route.....	16
Installing the Ball Mount Adapter.....	6	Using Suggested Routes.....	16
Turning the Device On or Off.....	6	Avoiding Delays, Tolls, and Areas.....	16
Acquiring GPS Signals.....	7	Avoiding Traffic Delays on Your Route.....	16
Home Screen.....	7	Avoiding Toll Roads.....	17
Opening an App.....	8	Avoiding Toll Stickers.....	17
Adding Shortcuts to the Home Screen.....	8	Avoiding Road Features.....	17
Viewing Notifications.....	8	Avoiding Environmental Zones.....	17
Status Bar Icons.....	8	Custom Avoidances.....	17
Using the Touchscreen.....	8	Avoiding a Road.....	17
Adjusting the Screen Brightness.....	9	Avoiding an Area.....	18
		Disabling a Custom Avoidance....	18
		Deleting Custom Avoidances.....	18
<b>Vehicle Profiles.....</b>	<b>9</b>	<b>Finding and Saving Locations.....</b>	<b>18</b>
Adding a Vehicle Profile.....	9	Points of Interest.....	19
Car Profile.....	9	Finding HISTORY Points of Interest.....	19
Switching the Vehicle Profile.....	10	Finding National Parks.....	19
Adding Propane Tanks.....	10	Finding Campgrounds.....	19
Editing a Vehicle Profile.....	10	Finding Campgrounds with Amenities.....	19
		Finding RV Services.....	19
<b>Driver Awareness Features and Alerts.....</b>	<b>11</b>	Finding a Location Using the Search Bar.....	20
Enabling or Disabling Driver Alerts.....	11	Finding an Address.....	20
Red Light and Speed Cameras.....	11	Finding a Location by Category.....	20
		Searching Within a Category.....	20
<b>Navigating to Your Destination.....</b>	<b>12</b>	Location Search Results.....	21
Routes.....	12	Changing the Search Area.....	21
Starting a Route.....	12	Custom Points of Interest.....	22
Starting a Route by Using the Map..	12	Installing POI Loader.....	22
Going Home.....	12	Finding Custom POIs.....	22
Editing Your Home Location.....	12	Parking.....	22
Your Route on the Map.....	13	Finding Parking Near Your Current Location.....	22
Active Lane Guidance.....	14	Understanding Parking Colors and Symbols.....	22
Viewing Turns and Directions.....	14	Search Tools.....	22
Viewing the Entire Route on the Map.....	14	Finding an Intersection.....	22
Arriving at Your Destination.....	14	Finding a Location Using Coordinates.....	23
Parking Near Your Destination.....	15	Foursquare.....	23
Changing Your Active Route.....	15		
Adding a Location to Your Route....	15		



Connecting to Your Foursquare Account.....	23	Viewing Upcoming Traffic.....	29
Searching Foursquare Points of Interest.....	23	Viewing Traffic on the Map.....	29
Viewing Foursquare Location Details.....	23	Searching for Traffic Incidents.....	30
TripAdvisor.....	23	Customizing the Map.....	30
Finding TripAdvisor Points of Interest.....	23	Customizing the Map Layers.....	30
Viewing Recently Found Locations.....	23	Changing the Map Data Field.....	30
Clearing the List of Recently Found Locations.....	24	Changing the Map Perspective.....	30
Viewing Current Location Information.....	24	<b>Live Services, Traffic, and Smartphone Features.....</b>	<b>30</b>
Finding Emergency Services and Fuel.....	24	Pairing with Your Smartphone.....	31
Getting Directions to Your Current Location.....	24	Tips After Pairing the Devices.....	31
Adding a Shortcut.....	24	Pairing Additional Bluetooth Devices.....	31
Removing a Shortcut.....	24	Going to an Address or Location Using the Garmin Drive App.....	31
Saving Locations.....	24	Smart Notifications.....	31
Saving a Location.....	24	Receiving Notifications.....	32
Saving Your Current Location.....	25	Hands-Free Calling.....	32
Editing a Saved Location.....	25	Placing a Call.....	32
Assigning Categories to a Saved Location.....	25	Receiving a Call.....	32
Deleting a Saved Location.....	25	Using In-Call Options.....	32
<b>Using the Map.....</b>	<b>26</b>	Saving a Phone Number as a Preset.....	33
Map Tools.....	26	Wireless Headsets.....	33
Viewing a Map Tool.....	26	Enabling or Disabling Bluetooth Features.....	33
Up Ahead.....	26	Showing or Hiding App Notifications (Android™).....	33
Viewing Upcoming Locations.....	27	Showing or Hiding Notification Categories for Your Apple® Device.....	33
Customizing the Up Ahead Categories.....	27	Disconnecting a Bluetooth Device.....	33
Cities Ahead.....	27	Deleting a Paired Bluetooth Device.....	33
Viewing Upcoming Cities and Exit Services.....	27	<b>Traffic.....</b>	<b>34</b>
Warning and Alert Symbols.....	27	Receiving Traffic Data Using Your Smartphone.....	34
Restriction Warnings.....	28	Receiving Traffic Data Using a Traffic Receiver.....	34
Road Condition Warnings.....	28	Viewing Traffic on the Map.....	34
Alerts.....	29	Searching for Traffic Incidents.....	34
Trip Information.....	29	<b>Voice Command.....</b>	<b>35</b>
Viewing Trip Data from the Map.....	29	Tips for Speaking to the Device.....	35
Customizing the Trip Data Fields.....	29	Launching Garmin Voice-Activated Navigation.....	35
Viewing the Trip Log.....	29		
Resetting Trip Information.....	29		



Checking Your Arrival Time.....	35
Placing a Phone Call Using Your Voice.....	35
Changing Device Settings Using Your Voice.....	35

## **Using the Apps..... 35**

Viewing the Owner's Manual on Your Device.....	35
Trip Planner.....	36
Planning a Trip.....	36
Editing and Reordering Locations in a Trip.....	36
Optimizing the Order of Destinations in a Trip.....	36
Discovering Attractions Along Your Trip.....	36
Changing Routing Options for a Trip.....	37
Navigating to a Saved Trip.....	37
Editing and Saving Your Active Route.....	37
TracBack®.....	37
Following Your Recent Track.....	37
Saving Your Recent Track as a Trip.....	37
Fusion-Link™ Wireless Remote Control App.....	38
Connecting to a Stereo Using Bluetooth.....	38
Connecting to a Stereo Using a Wireless Network.....	38
Music Playback.....	38
Playing Music.....	38
Selecting a Source.....	38
Playback Controls.....	39
Audio Control.....	39
Adjusting the Volume for a Zone.....	39
Adjusting the Tones.....	39
Disabling the Loud Setting for a Zone.....	39
Adjusting the Gain for an Auxiliary Device.....	40
Speaker Zones.....	40
DSP Settings.....	40
Presets.....	41
Saving a Station as a Preset.....	41

Selecting a Preset from a List.....	41
Removing Presets.....	41
Audio Settings.....	41
Speaker Zone Settings.....	41
Logging Service History.....	42
Adding Service Categories.....	42
Deleting Service Categories.....	42
Renaming Service Categories.....	42
Editing a Service Record.....	43
Deleting Service Records.....	43
Viewing Previous Routes and Destinations.....	43
Viewing the Weather Forecast.....	43
Viewing Weather Near a Different City.....	43
Garmin PowerSwitch™ App.....	44
Activating a Power Switch.....	44
Turning Off All Switches.....	44
Customizing a Button.....	45
Assigning a Switch to a Control Input.....	45
Adding a Custom Layout.....	45
Adding a Button to a Custom Layout.....	46
Arranging Buttons In a Custom Layout.....	46
Deleting a Custom Layout or Button.....	46

## **Settings..... 47**

Navigation Settings.....	47
Map and Vehicle Settings.....	47
Enabling Maps.....	47
Connecting to a Wireless Network.....	47
Enabling Bluetooth Wireless Technology.....	47
Driver Assistance Settings.....	48
Traffic Settings.....	48
Display Settings.....	48
Sound and Notification Settings.....	48
Adjusting Sound and Notification Volume.....	49
Setting an Alarm.....	49
Enabling or Disabling Location Services.....	49
Setting the Text Language.....	49
Date and Time Settings.....	49
Device Settings.....	49



Restoring Settings.....	49	Connecting the Device to Vehicle Power.....	59
<b>Device Information.....</b>	<b>50</b>	Pairing with a Garmin Navigation Device.....	60
Viewing E-label Regulatory and Compliance Information.....	50	Garmin PowerSwitch Specifications.....	60
Specifications.....	50	Troubleshooting.....	60
Charging the Device.....	50	My Garmin PowerSwitch will not stay connected.....	60
<b>Device Maintenance.....</b>	<b>50</b>	My accessories are not receiving power.....	60
Garmin Support Center.....	50	Backup Cameras.....	60
Updating Maps and Software Using a Wi-Fi Network.....	51	Pairing a BC™ 35 Backup Camera with a Garmin Navigation Device.....	61
Updating Maps and Software with Garmin Express.....	52	Connecting a Wired Backup Camera.....	61
Installing Garmin Express.....	53	Viewing the Backup Camera.....	62
Device Care.....	53	Switching Cameras.....	62
Cleaning the Outer Casing.....	53	Changing the Camera Orientation.....	62
Cleaning the Touchscreen.....	53	Connecting a Dash Camera to the Powered Mount.....	63
Avoiding Theft.....	53	Data Management.....	63
Resetting the Device.....	53	About Memory Cards.....	63
Removing the Device, Mount, and Suction Cup.....	53	Installing a Memory Card for Maps and Data.....	63
Removing the Mount from the Suction Cup.....	53	Formatting the Memory Card.....	64
Removing the Suction Cup from the Windshield.....	54	Connecting the Device to Your Computer.....	64
<b>Troubleshooting.....</b>	<b>54</b>	Transferring Data From Your Computer.....	64
The suction cup will not stay on my windshield.....	54	Transferring GPX Files From Your Computer.....	64
The mount does not hold my device in place while I drive.....	54	Exporting GPX Files with the Garmin Drive App.....	65
My device is not acquiring satellite signals.....	54	Importing GPX Files with the Garmin Drive App.....	65
The device does not charge in my vehicle.....	54	Exporting GPX Files with a Memory Card.....	65
My battery does not stay charged for very long.....	54	Importing GPX Files with a Memory Card.....	65
My device does not connect to my phone.....	55	Purchasing Additional Maps.....	65
<b>Appendix.....</b>	<b>55</b>	Purchasing Accessories.....	65
Garmin PowerSwitch.....	55	<b>Index.....</b>	<b>66</b>
Mounting Considerations.....	55		
Mounting the Device.....	56		
Opening the Front Cover.....	57		
Connecting Accessories.....	58		
Connecting a Control Input.....	59		



# Getting Started

## WARNING

See the *Important Safety and Product Information* guide in the product box for product warnings and other important information.

- Update the maps and software on your device (*Updating Maps and Software Using a Wi-Fi Network*, page 51).
- Mount the device in your vehicle and connect it to power (*Mounting and Powering the Device in Your Vehicle*, page 3).
- Adjust the volume (*Adjusting Sound and Notification Volume*, page 49) and display brightness (*Adjusting the Screen Brightness*, page 9).
- Set up a vehicle profile for your camper (*Adding a Vehicle Profile*, page 9).
- Navigate to your destination (*Starting a Route*, page 12).



## Device Overview



- |   |   |
|---|---|
| ① | Microphone for hands-free calling and voice command |
| ② | Volume control                                      |
| ③ | Power key   |
| ④ | Micro USB power and data port                       |
| ⑤ | Map and data memory card slot                       |
| ⑥ | Magnetic mount interface with 14-pin connector      |
| ⑦ | Speaker   |

## Mounting and Powering the Device in Your Vehicle

### ⚠ WARNING

This product contains a lithium-ion battery. To prevent the possibility of personal injury or product damage caused by battery exposure to extreme heat, store the device out of direct sunlight.

Both the device and its mount contain magnets. Under certain circumstances, magnets may cause interference with some internal medical devices and electronic devices, including pacemakers, insulin pumps, or hard drives in laptop computers. Keep the device away from medical devices and electronic devices.

Before you use your device on battery power, you should charge it.

- 1 Open the lever ①, press the suction cup to the windshield, and flip the lever back toward the windshield. The lever must be oriented toward the top of the windshield.



- 2 Plug the vehicle power cable into the port ② on the mount.
- 3 If necessary, loosen the thumbscrew on the suction cup arm ③ and the nut on the ball mount ④, and adjust the mount for better viewing and operation.



- 4 Tighten the thumbscrew on the suction cup arm and the nut on the ball mount.
- 5 Place the device onto the magnetic mount.



- 6 Plug the other end of the vehicle power cable into a power outlet in your vehicle.

## Installing the Screw-Down Mount on the Dashboard

Before you can attach the screw-down ball mount to your dashboard, you must select a suitable location on the dashboard.

### ⚠ WARNING

It is your responsibility to ensure the mounting location complies with all applicable laws and ordinances, and does not block your view of the road during the safe operation of your vehicle.

### NOTICE

Avoid wires, gauges, air bags, air bag covers, HVAC, and other items when drilling pilot holes and attaching the mount to the vehicle. Garmin® is not responsible for any damages or consequences arising from the installation.

### NOTICE

Garmin recommends professional installation of the screw-down ball mount.

- 1 Place the mount ① on the selected location.

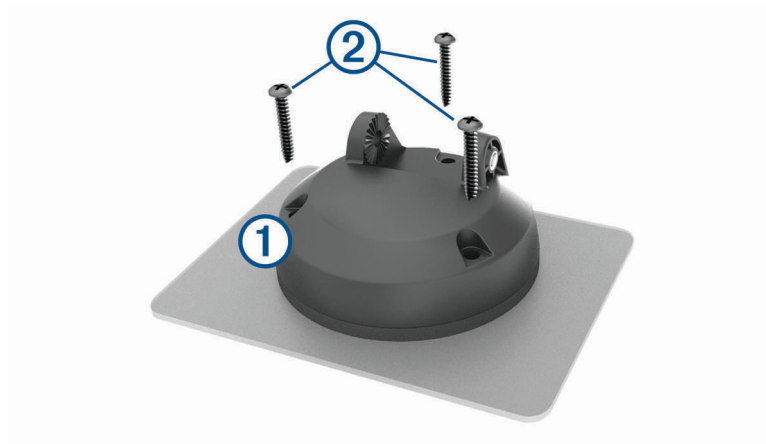

- 2 Using the mount as a template, mark the three screw locations.
- 3 Drill pilot holes (optional).  
For some types of mounting material, drilling pilot holes is necessary.
- 4 Securely fasten the mount to the surface using the supplied screws ②.
- 5 Insert the ball mount arm ③ into the mount.

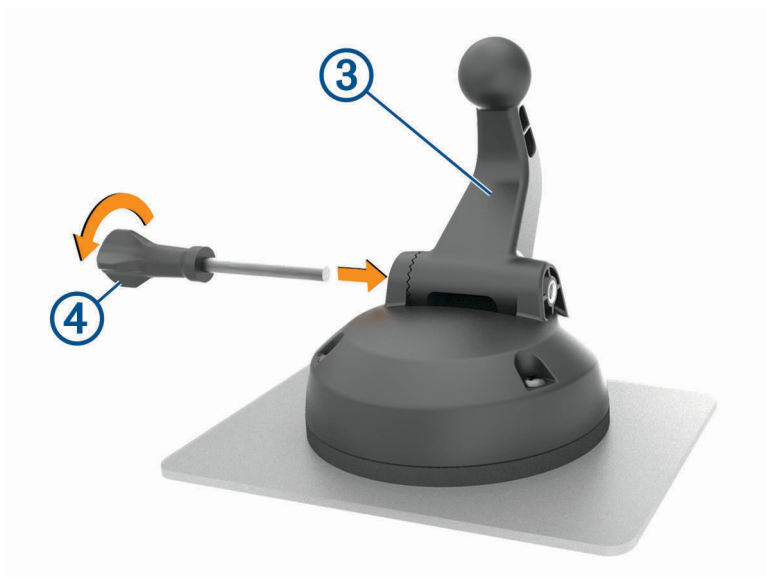

- 6 Insert the thumbscrew ④ into the mount, and tighten it to secure the ball mount arm.

## Installing the Ball Mount Adapter

Your device includes a one-inch ball mount that is compatible with third-party mounting solutions.

- 1 Remove the four screws ① securing the mount socket ② to the magnetic mount.

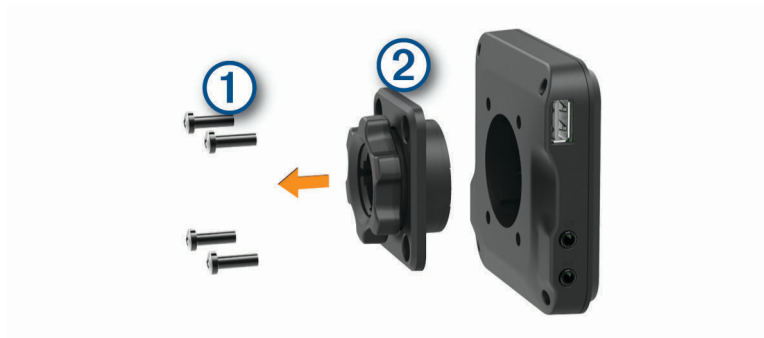

- 2 Remove the mount socket.

- 3 Secure the one-inch ball mount ③ to the magnetic mount using the screws removed in step 1.

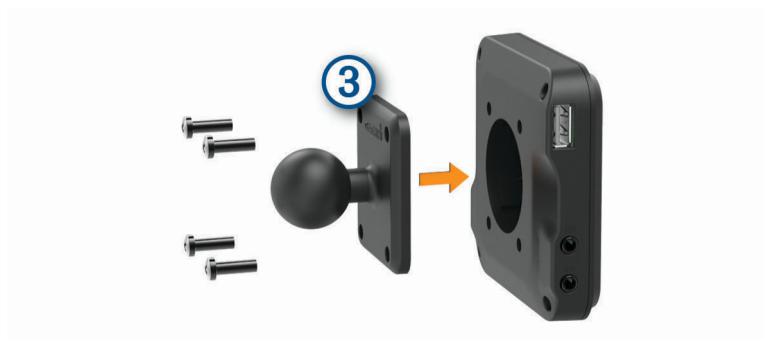

## Turning the Device On or Off

- To turn the device on, press the power key ①, or connect the device to power.



- To put the device in power saving mode, press the power key while the device is on. While in power saving mode, the screen is off and the device uses very little power, but it can wake instantly for use.  
**TIP:** You can charge your device faster by putting it in power saving mode while charging the battery.
- To turn off the device completely, hold the power key until a prompt appears on the screen, and select **Power Off**.

## Acquiring GPS Signals

When you turn on your navigation device, the GPS receiver must collect satellite data and establish the current location. The time required to acquire satellite signals varies based on several factors, including how far you are from the location where you last used your navigation device, whether you have a clear view of the sky, and how long it has been since you last used your navigation device. The first time you turn on your navigation device, it may take several minutes to acquire satellite signals.

- 1 Turn on the device.
- 2 Verify  appears in the status bar, and enable location services if it does not ([Enabling or Disabling Location Services, page 49](#)).
- 3 If necessary, go to an open area with a clear view of the sky, away from tall buildings and trees.  
Acquiring Satellites appears at the top of the navigation map until the device determines your location.

## Home Screen

**NOTE:** The home screen layout may vary if it has been customized.



- 1 Swipe down to view notifications.  
Swipe down twice to quickly change settings and backlight brightness.
- 2 Select to start a route.
- 3 Select to view the map.
- 4 Select to change your vehicle profile.
- 5 Select to view weather information for your current location. The Garmin Drive™ app is required.
- 6 Select to view smart notifications. The Garmin Drive app is required.
- 7 Select to open the app drawer. The app drawer contains shortcuts to all the apps installed on your device.
- 8 Hold to customize the wallpaper or add widgets to the home screen.

## Opening an App

The home screen contains shortcuts for frequently used apps. The app drawer contains all the apps installed on your device, organized into two tabs. The Navigation tab contains Garmin apps useful for navigation, dispatching, and hours of service recording. The Tools tab contains apps useful for communication and other tasks.

Select an option to open an app:

- Select an app shortcut from the home screen.
- Select , select a tab, and select an app.

## Adding Shortcuts to the Home Screen







- 1 Select .
- 2 Select an app tab to view additional applications.
- 3 Hold an application, and drag it to a location on the home screen.

## Viewing Notifications

- 1 Swipe down from the top of the screen.  
The list of notifications appears.
- 2 Select an option:
  - To launch the action or app mentioned in the notification, select the notification.
  - To dismiss a notification, swipe the notification to the right.

## Status Bar Icons

The status bar is located at the top of the main menu. The status bar icons display information about features on the device.

	Location services is enabled ( <a href="#">Enabling or Disabling Location Services, page 49</a> ).
	Bluetooth® technology is enabled.
	Connected to a Bluetooth device.
	Connected to a Wi-Fi® network ( <a href="#">Connecting to a Wireless Network, page 47</a> ).
 	Active vehicle profile. Swipe down twice and select to view the vehicle profile settings ( <a href="#">Vehicle Profiles, page 9</a> ).
	Battery charge level.

## Using the Touchscreen

- Tap the screen to select an item.
- Drag or swipe your finger across the screen to pan or scroll.
- Pinch two fingers together to zoom out.
- Spread two fingers apart to zoom in.

## Adjusting the Screen Brightness

The device can use an ambient light sensor to adjust the screen brightness to your vehicle conditions automatically ([Display Settings, page 48](#)). You can also adjust the brightness manually, using either the notification panel or the settings menu.

- 1 Select an option:
  - Swipe down twice from the top of the screen to expand the quick settings in the notification panel.
  - Select **Settings > Device > Display > Brightness Level**.
- 2 Use the slider bar to adjust the brightness.

## Vehicle Profiles

### WARNING

Entering your vehicle profile characteristics does not guarantee that your vehicle's characteristics will be accounted for in all route suggestions or that you will receive the warning icons in all cases. Limitations may exist in the map data such that your device cannot account for these restrictions or road conditions in all cases. Always defer to all posted road signs and road conditions when making driving decisions.

Routing and navigation are calculated differently based on your vehicle profile. The activated vehicle profile is indicated by an icon in the status bar. The navigation and map settings on your device can be customized separately for each vehicle type.

When you activate a camper vehicle profile, the device avoids including restricted or impassable areas in routes based on the dimensions, weight, and other characteristics you entered for your vehicle.

## Adding a Vehicle Profile

You should add a vehicle profile for each camper to be used with your device.

- 1 Select the vehicle profile from the homescreen.
- 2 Select your vehicle type:
  - To add a motorhome with a permanently attached camper, select **Motorhome**.
  - To add a motorhome pulling a trailer, select **Motorhome with Trailer**.
  - To add a camper pulled behind a passenger vehicle, select **Vehicle with Trailer**.
- 3 If necessary, select your trailer type:
  - To add a camper pulled using a standard hitch, select **Travel Trailer**.
  - To add a camper pulled using a fifth-wheel hitch, select **Fifth Wheel**.  
**NOTE:** This trailer type is not available in all areas.
  - To add a boat trailer pulled using a standard hitch, select **Boat Trailer**.
  - To add a trailer pulled using a standard hitch, select **Trailer**.
- 4 Follow the on-screen instructions to enter the vehicle characteristics.



After you add a vehicle profile, you can edit the profile to enter additional detailed information ([Editing a Vehicle Profile, page 10](#)).

## Car Profile

The car profile is a preloaded vehicle profile intended for use in an automobile without a trailer. While using the car profile, the device calculates standard automobile routes, and routing for large vehicles is not available. Some features and settings specific to large vehicles are not available while using the car profile.

## Switching the Vehicle Profile

Each time you turn on your device, it prompts you to select a vehicle profile. You can manually switch to another vehicle profile at any time.

- 1 Select an option:
  - Swipe down twice from the top of the screen, and select the vehicle profile icon, such as  or .
  - From the home screen, select the vehicle profile widget ([Home Screen, page 7](#)).
- 2 Select a vehicle profile.

The vehicle profile information appears, including measurements and weight.
- 3 Select **Select**.

## Adding Propane Tanks





**NOTE:** This feature is not available on all product models.

When you add your propane tanks to your vehicle profile, the device avoids routing through areas with propane tank restrictions that may affect your route. The device also alerts you when you approach areas that require you to shut off your propane tanks.

- 1 From the vehicle profile, select  > **Add Tank**.
- 2 Enter the weight of the propane tank, and select **Save**.

## Editing a Vehicle Profile

You can change basic vehicle profile information or add detailed information to a vehicle profile, such as maximum speed.

- 1 From the home screen, select the vehicle profile widget ([Home Screen, page 7](#)).
- 2 Select the vehicle profile to edit.
- 3 Select an option:
  - To edit the vehicle profile information, select , and select a field to edit.
  - To rename a vehicle profile, select  >  > **Rename Profile**.
  - To delete the vehicle profile, select  >  > **Delete**.

# Driver Awareness Features and Alerts

## ⚠ CAUTION

The driver alerts and speed limit features are for information only and do not replace your responsibility to abide by all posted speed limit signs and to use safe driving judgment at all times. Garmin is not responsible for any traffic fines or citations you receive for failing to follow all applicable traffic laws and signs.

Your device provides features that can help encourage safer driving and increase efficiency, even when you are driving in a familiar area. The device plays an audible tone or message and displays information for each alert. You can enable or disable the audible tone for some types of driver alerts. Not all alerts are available in all areas.

**Schools:** The device plays a tone and displays the speed limit (if available) for an upcoming school or school zone.

**Speed limit exceeded:** The device plays a tone and displays a red border on the speed limit icon when you exceed the posted speed limit for the current road.

**Speed limit change:** The device plays a tone and displays the upcoming speed limit so you can be prepared to adjust your speed.

**Railroad crossing:** The device plays a tone to indicate an upcoming railroad crossing.

**Animal crossing:** The device plays a tone to indicate an upcoming animal crossing area.

**Curves:** The device plays a tone to indicate a curve in the road.

**Slower traffic:** The device plays a tone to indicate slower traffic when you approach slower traffic at a higher speed. Your device must be receiving traffic information to use this feature ([Traffic, page 34](#)).

**Risk of grounding:** The device plays a tone and displays a message when you approach a road where your vehicle could become grounded.

**Lateral wind:** The device plays a tone and displays a message when you approach a road where there is risk of lateral wind.

**Narrow road:** The device plays a tone and displays a message when you approach a road that may be too narrow for your vehicle.

**Steep hill:** The device plays a tone and displays a message when you approach a steep hill.

**State and country borders:** The device plays a tone and displays a message when you approach the border of a state or country.

**Shut off propane:** The device plays a tone and displays a message when you approach an area where propane should be turned off.

## Enabling or Disabling Driver Alerts

You can enable or disable several types of driver alerts.

- 1 Select **Settings** > **Driver Assistance** > **Audible Driver Alerts**.
- 2 Select or clear the check box next to each alert.

## Red Light and Speed Cameras

### NOTICE

Garmin is not responsible for the accuracy of or the consequences of using a red light or speed camera database.

**NOTE:** This feature is not available for all regions or product models.

Information about red light and speed camera locations is available in some areas for some product models. The device alerts you when you approach a reported speed or red light camera.

- In some areas, your device can receive live red light and speed camera data while connected to a smartphone running the Garmin Drive app.
- You can use the Garmin Express™ software ([garmin.com/express](http://garmin.com/express)) to update the camera database stored on your device. You should update your device frequently to receive the most up-to-date camera information.

# Navigating to Your Destination

## Routes

A route is a path from your current location to one or more destinations.

- The device calculates a recommended route to your destination based on the preferences you set, including the route calculation mode ([Changing the Route Calculation Mode, page 16](#)) and avoidances ([Avoiding Delays, Tolls, and Areas, page 16](#)).
- The device can automatically avoid roads that are not appropriate for the active vehicle profile.
- You can start navigating to your destination quickly using the recommended route, or you can select an alternate route ([Starting a Route, page 12](#)).
- If there are specific roads you need to use or avoid, you can customize the route.
- You can add multiple destinations to a route ([Adding a Location to Your Route, page 15](#)).

## Starting a Route

- 1 Select **Where To?**, and search for a location ([Finding and Saving Locations, page 18](#)).
- 2 Select a location.
- 3 Select an option:
  - To start navigating using the recommended route, select **Go!**.
  - To choose an alternate route, select **Y**, and select a route.  
Alternate routes appear to the right of the map.
  - To edit the course of the route, select **Y** > **Edit Route**, and add shaping points to the route.

The device calculates a route to the location and guides you using voice prompts and information on the map ([Your Route on the Map, page 13](#)). A preview of the major roads in your route appears at the edge of the map for several seconds.

If you need to stop at additional destinations, you can add the locations to your route ([Adding a Location to Your Route, page 15](#)).

## Starting a Route by Using the Map

You can start a route by selecting a location from the map.

- 1 Select **View Map**.
- 2 Drag and zoom the map to display the area to search.
- 3 Select a point, such as a street, intersection, or address location.
- 4 Select **Go!**.

## Going Home

The first time you start a route home, the device prompts you to enter your home location.

- 1 Select **Where To?** > **Go Home**.
- 2 If necessary, enter your home location.

## Editing Your Home Location

- 1 Select **Where To?** > **≡** > **Set Home Location**.
- 2 Enter your home location.

## Your Route on the Map

As you travel, the device guides you to your destination using voice prompts and information on the map. Instructions for your next turn or exit, or other actions appear across the top of the map.

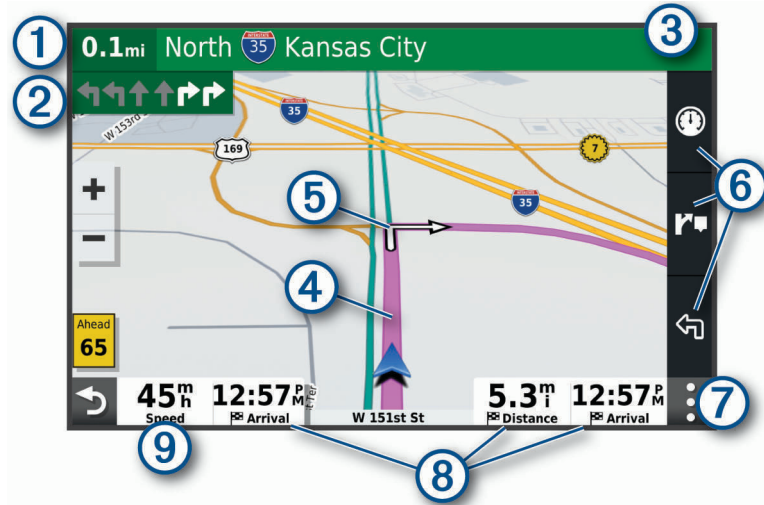

- ① Distance to the next action.
- ② Next action in the route. Indicates the next turn, exit, or other action and the lane in which you should travel, if available.
- ③ Name of the street or exit associated with the next action.
- ④ Route highlighted on the map.
- ⑤ Next action in the route. Arrows on the map indicate the location of upcoming actions.
- ⑥ Map tool shortcuts.
- ⑦ Map tools. You can select the tools to show you more information about your route and surroundings.
- ⑧ Data fields.  
**TIP:** You can touch these fields to change the information they show (*Changing the Map Data Field*, page 30).
- ⑨ Vehicle speed.

## Active Lane Guidance

As you approach some turns, exits, or interchanges in your route, a detailed simulation of the road appears beside the map, if available. A colored line ① indicates the proper lane for the turn.

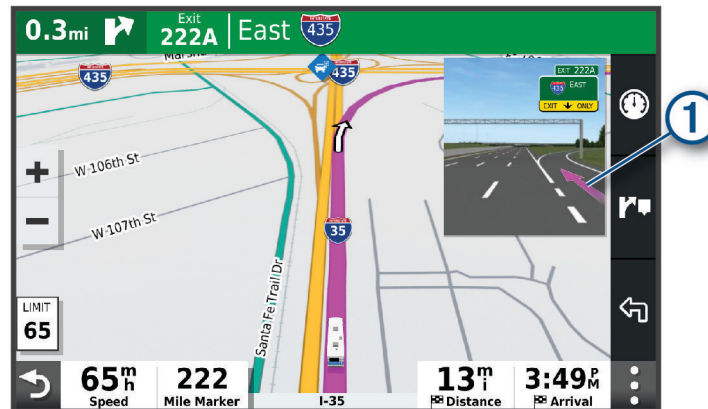

## Viewing Turns and Directions

While navigating a route, you can view upcoming turns, lane changes, or other directions for your route.

- 1 From the map, select an option:
  - To view upcoming turns and directions as you navigate, select **> Turns**.  
The map tool displays the next several turns or directions beside the map. The list updates automatically as you navigate the route.
  - To view the complete list of turns and directions for the entire route, select the text bar at the top of the map.
- 2 Select a turn or direction (optional).  
Detailed information appears. An image of the junction may appear for junctions on major roadways, if available.

## Viewing the Entire Route on the Map

- 1 While navigating a route, select anywhere on the map.
- 2 Select .

## Arriving at Your Destination

When you approach your destination, the device provides information to help you complete your route.

-  indicates the location of your destination on the map, and a voice prompt announces you are approaching your destination.
- When you approach some destinations, the device automatically suggests parking areas. You can select More to view a full list of suggested parking areas ([Parking Near Your Destination, page 15](#)).
- When you stop at your destination, the device automatically ends the route. If the device does not detect your arrival automatically, you can select Stop to end your route.

## Parking Near Your Destination

Your device can help you find a parking spot near your destination. When you approach some destinations, the device automatically suggests parking areas.

- 1 Select an option:
    - When the device suggests parking, select **More** to see all suggested parking areas.  
**NOTE:** When you select a suggested parking area, the device automatically updates your route.
    - If the device does not suggest parking locations, select **Where To?** > **Categories** > **Parking**, and select  > **My Destination**.
  - 2 Select **Filter Parking**, and select one or more categories to filter parking by availability, type, price, or payment methods (optional).  
**NOTE:** Detailed parking data is not available in all areas or for all parking locations.
  - 3 Select a parking location, and select **Go!**.
- The device guides you to the parking area.

## Changing Your Active Route

### Adding a Location to Your Route

Before you can add a location to your route, you must be navigating a route ([Starting a Route, page 12](#)).

You can add locations to the middle or end of your route. For example, you can add a fuel station as the next destination in your route.

**TIP:** To create complex routes with multiple destinations or scheduled stops, you can use the trip planner to plan, schedule, and save a trip ([Planning a Trip, page 36](#)).

- 1 From the map, select  > **Where To?**
- 2 Search for a location ([Finding and Saving Locations, page 18](#)).
- 3 Select a location.
- 4 Select **Go!**.
- 5 Select an option:
  - To add the location as the next destination in your route, select **Add As Next Stop**.
  - To add the location to the end of your route, select **Add As Last Stop**.
  - To add the location and edit the order of destinations in your route, select **Add to Active Route**.

The device re-calculates the route to include the added location and guides you to the destinations in order.

### Shaping Your Route

Before you can shape your route, you must start a route ([Starting a Route, page 12](#)).

You can manually shape your route to change its course. This allows you to direct the route to use a certain road or go through a certain area without adding a destination to the route.

- 1 Touch anywhere on the map.
- 2 Select **Shape Route**.  
**TIP:** You can select  to zoom in on the map and select a more precise location.  
The device enters route shaping mode and recalculates the route to travel through the selected location.
- 3 Select **Go!**.
- 4 If necessary, select an option:
  - To add more shaping points to the route, select additional locations on the map.
  - To remove a shaping point, select the shaping point and select **Remove**.

## Taking a Detour

You can take a detour for a specified distance along your route or detour around specific roads. This is useful if you encounter construction zones, closed roads, or poor road conditions.

- 1 From the map, select  > **Edit Route**.
- 2 Select an option:
  - To detour your route for a specific distance, select **Detour by Distance**.
  - To detour around a specific road on the route, select **Detour by Road**.

## Changing the Route Calculation Mode

- 1 Select **Settings** > **Navigation** > **Calculation Mode**.
- 2 Select an option:
  - Select **Faster Time** to calculate routes that are faster to drive but can be longer in distance.
  - Select **Off Road** to calculate point-to-point routes (without roads).
  - Select **Shorter Distance** to calculate routes that are shorter in distance but can take more time to drive.

## Stopping the Route

- From the map, select  > **Stop**.
- From the home screen, select **Stop**.

## Using Suggested Routes

Before you can use this feature, you must save at least one location and enable the travel history feature ([Navigation Settings, page 47](#)).

Using the myTrends™ feature, your device predicts your destination based on your travel history, the day of the week, and the time of day. After you have driven to a saved location several times, the location may appear in the navigation bar on the map, along with the estimated time of travel, and traffic information.

Select the navigation bar to view a suggested route to the location.

## Avoiding Delays, Tolls, and Areas

### Avoiding Traffic Delays on Your Route

Before you can avoid traffic delays, you must be receiving traffic information ([Receiving Traffic Data Using Your Smartphone, page 34](#)).

By default, the device optimizes your route to avoid traffic delays automatically. If you have disabled this option in the traffic settings ([Traffic Settings, page 48](#)), you can view and avoid traffic delays manually.

- 1 While navigating a route, select  > **Traffic**.
- 2 Select **Alternate Route**, if available.
- 3 Select **Go!**.

## Avoiding Toll Roads

Your device can avoid routing you through areas that require tolls, such as toll roads, toll bridges, or congestion areas. The device may still include a toll area in your route if no other reasonable routes are available.

1 Select **Settings > Navigation**.

2 Select an option:

**NOTE:** The menu changes based on your area and the map data on your device.

- Select **Toll Roads**.
- Select **Tolls and Fees > Toll Roads**.

3 Select an option:

- To be asked each time before routing through a toll area, select **Always Ask**.
- To always avoid tolls, select **Avoid**.
- To always allow tolls, select **Allow**.

## Avoiding Toll Stickers

If the map data on your device contains detailed toll sticker information, you can avoid or allow roads that require toll stickers for each country.

**NOTE:** This feature is not available in all areas.

1 Select **Settings > Navigation > Tolls and Fees > Toll Stickers**.

2 Select a country.

3 Select an option:

- To be asked each time before routing through an area that requires toll stickers, select **Always Ask**.
- To always avoid roads that require toll stickers, select **Avoid**.
- To always allow roads that require toll stickers, select **Allow**.

## Avoiding Road Features

1 Select **Settings > Navigation > Avoidances**.

2 Select the road features to avoid on your routes, and select **OK**.

## Avoiding Environmental Zones

Your device can avoid areas with environmental or emissions restrictions that may apply to your vehicle. This option applies to the vehicle type in the active vehicle profile ([Vehicle Profiles, page 9](#)).

1 Select **Settings > Navigation > Environmental Zones**.

2 Select an option:

- To be asked each time before routing through an environmental zone, select **Always Ask**.
- To always avoid environmental zones, select **Avoid**.
- To always allow environmental zones, select **Allow**.

## Custom Avoidances

Custom avoidances allow you to select specific areas or sections of road to avoid. When the device calculates a route, it avoids these areas and roads unless no other reasonable route is available.

### Avoiding a Road

1 Select **Settings > Navigation > Custom Avoidances**.

2 If necessary, select **Add Avoidance**.

3 Select **Add Avoid Road**.

4 Select the starting point of the section of road to avoid, and select **Next**.

5 Select the ending point of the road section, and select **Next**.

6 Select **Done**.



## Avoiding an Area

- 1 Select **Settings** > **Navigation** > **Custom Avoidances**.
- 2 If necessary, select **Add Avoidance**.
- 3 Select **Add Avoid Area**.
- 4 Select the upper-left corner of the area to avoid, and select **Next**.
- 5 Select the lower-right corner of the area to avoid, and select **Next**.  
The selected area is shaded on the map.
- 6 Select **Done**.

## Disabling a Custom Avoidance

You can disable a custom avoidance without deleting it.

- 1 Select **Settings** > **Navigation** > **Custom Avoidances**.
- 2 Select an avoidance.
- 3 Select  > **Disable**.

## Deleting Custom Avoidances

- 1 Select **Settings** > **Navigation** > **Custom Avoidances** > .
- 2 Select an option:
  - To delete all custom avoidances, select **Select All** > **Delete**.
  - To delete one custom avoidance, select the avoidance, and select **Delete**.

# Finding and Saving Locations

The maps loaded in your device contain locations, such as restaurants, hotels, auto services, and detailed street information. The Where To? menu helps you find your destination by providing several methods to browse, search, and save this information.

From the main menu, select **Where To?**.

- To quickly search all locations on your device, select **Search** (*Finding a Location Using the Search Bar, page 20*).
- To find an address, select **Address** (*Finding an Address, page 20*).
- To browse or search pre-loaded points of interest by category, select **Categories** (*Finding a Location by Category, page 20*).
- To search near a different city or area, select  next to the current search area (*Changing the Search Area, page 21*).
- To view and edit your saved locations, select **Saved** (*Saving Locations, page 24*).
- To view locations you have recently selected from the search results, select **Recent** (*Viewing Recently Found Locations, page 23*).
- To search for RV parks and campgrounds, select **All Campgrounds** (*Finding Campgrounds, page 19*).
- To browse, search, and check into Foursquare® points of interest, select **Foursquare** (*Searching Foursquare Points of Interest, page 23*).
- To browse and search TripAdvisor® points of interest and reviews, select **TripAdvisor** (*TripAdvisor, page 23*).
- To browse and search HISTORY® points of interest, photos, and information, select **HISTORY** (*Finding HISTORY Points of Interest, page 19*).
- To find national parks and explore park maps, select **National Parks** (*Finding National Parks, page 19*).
- To navigate to specific geographic coordinates, select **Coordinates** (*Finding a Location Using Coordinates, page 23*).

## Points of Interest

A point of interest is a place that you may find useful or interesting. Points of interest are organized by category and can include popular travel destinations such as gas stations, restaurants, hotels, and entertainment venues.

### Finding HISTORY Points of Interest

**NOTE:** This feature is not available on all product models or for all map regions.

Your device includes HISTORY points of interest, which allow you to find and learn about historically significant locations and attractions, such as historic buildings, monuments, museums, and notable locations of historic events.

- 1 Select **Where To? > HISTORY**.
- 2 Select a category.
- 3 Select a location.
- 4 Select  to view a photo and a short summary of the location's history.

### Finding National Parks

Device models that include maps for North America or the United States also include detailed information for national parks in the United States. You can navigate to a national park or to a location within a national park.

- 1 Select **Where To? > National Parks**.  
A list of national parks appears, with the nearest park at the top.
- 2 Select **Search**, and enter all or part of the park name to narrow the results (optional).
- 3 Select a national park.  
A list of categories for locations of features and amenities within the park appears below the park name.
- 4 Select an option:
  - To start navigating to the park, select **Go!**.
  - To view more park information or explore the park features and amenities, select .
  - To quickly find a location within the park, select a category from the list below the park name, and select a location.

### Finding Campgrounds

Select **Where To? > All Campgrounds**.

### Finding Campgrounds with Amenities

You can search for RV parks and campgrounds based on the amenities available.

- 1 Select **Where To?**.
- 2 Select an RV parks and campgrounds search provider, such as **PlanRV Parks**, **ACSI**, or **Ultimate Public Campgrounds**.  
**NOTE:** All search providers are not available on all product models.
- 3 If necessary, select **Filter by Amenities**, select one or more amenities, and select **Save**.
- 4 Select a location.

### Finding RV Services

**NOTE:** This feature is not available in all areas.

You can find nearby locations that offer repair, towing, and other services for RVs.

Select **Where To? > PlanRV Services**.

## Finding a Location Using the Search Bar

You can use the search bar to search for locations by entering a category, brand name, address, or city name.

- 1 Select **Where To?**.
- 2 Select **Search** in the search bar.
- 3 Enter all or part of the search term.  
Suggested search terms appear below the search bar.
- 4 Select an option:
  - To search for a type of business, enter a category name (for example, "movie theaters").
  - To search for a business name, enter all or part of the name.
  - To search for an address near you, enter the house number and street name.
  - To search for an address in another city, enter the house number, street name, city, and state.
  - To search for a city, enter the city and state.
  - To search for coordinates, enter latitude and longitude coordinates.
- 5 Select an option:
  - To search using a suggested search term, select the term.
  - To search using the text you entered, select **Q**.
- 6 If necessary, select a location.

## Finding an Address

**NOTE:** The order of the steps may change depending on the map data loaded on your device.

- 1 Select **Where To?**.
- 2 If necessary, select  to search near a different city or area.
- 3 Select **Address**.
- 4 Follow the on-screen instructions to enter address information.
- 5 Select the address.

## Finding a Location by Category

- 1 Select **Where To?**.
- 2 Select a category, or select **Categories**.
- 3 If necessary, select a subcategory.
- 4 Select a location.

## Searching Within a Category

After you have performed a search for a point of interest, certain categories may display a Quick Search list that shows the last four destinations you selected.

- 1 Select **Where To? > Categories**.
- 2 Select a category.
- 3 Select an option:
  - Select a destination from the quick search list on the right side of the screen.  
The quick search list provides a list of recently found locations in the selected category.
  - Select a subcategory, if necessary, and select a destination.

## Location Search Results

The location search results appear in a list, with the nearest location at the top. Each numbered location also appears on the map. You can scroll down to view more results.



①	Select a location to view the option menu.
②	Select to view detailed information about the location.
③	Select to view alternate routes to the location.
④ Go!	Select to start navigating to the location using the recommended route.

## Changing the Search Area

By default, the device searches for locations near your current location. You can also search other areas, such as near your destination, near another city, or along your active route.

- 1 Select **Where To?**.
- 2 Select next to the current search area ①.

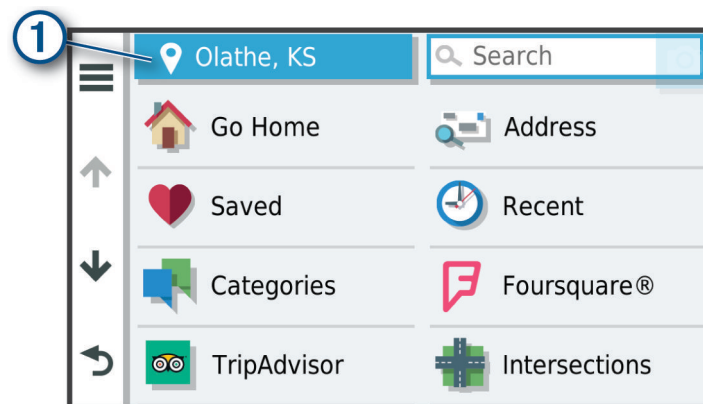

- 3 Select a search area.
- 4 If necessary, follow the on-screen instructions to select a specific location.

The selected search area appears next to . When you search for a location using any of the options in the Where To? menu, the device suggests locations near this area first.

## Custom Points of Interest

Custom POIs are customized points on the map. They can contain alerts that let you know if you are near a designated point or if you are traveling faster than a specified speed.

### Installing POI Loader

You can create or download custom POI lists on your computer and install them on your device using POI Loader software.

- 1 Go to [www.garmin.com/poiloader](http://www.garmin.com/poiloader).
- 2 Follow the on-screen instructions.

### Finding Custom POIs

Before you can find custom POIs, you must load custom POIs on your device using the POI Loader software (*Installing POI Loader, page 22*).

- 1 Select **Where To? > Categories**.
- 2 Scroll to the Other Categories section, and select a category.

## Parking

Your RV / Camper device includes detailed parking data, which can help you find nearby parking based on the likelihood of available parking spots, type of parking area, price, or accepted payment methods.

In some areas, live on-street parking data is available while your RV / Camper device is connected to the Garmin Drive app. While your device is receiving live parking data, you can view real-time parking trends.

**NOTE:** Detailed parking data is not available in all areas or for all parking locations. Garmin is not responsible for the accuracy or timeliness of live parking data.

### Finding Parking Near Your Current Location

- 1 Select **Where To? > Categories > Parking**.
- 2 Select **Filter Parking**, and select one or more categories to filter parking by availability, type, price, or payment methods (optional).

**NOTE:** Detailed parking data is not available in all areas or for all parking locations.

- 3 Select a parking location.
- 4 Select **Go!**.

### Understanding Parking Colors and Symbols

Parking locations that include detailed parking data are color-coded to show the likelihood of finding parking. Symbols indicate the type of parking available (street or lot), relative pricing information, and payment type.

You can view the legend for these colors and symbols on the device.

From the parking search results, select .

## Search Tools

Search tools allow you to search for specific types of locations by responding to on-screen prompts.

### Finding an Intersection

You can search for an intersection or junction between two streets, highways, or other roads.

- 1 Select **Where To? > Intersections**.
- 2 Follow the on-screen instructions to enter street information.
- 3 Select the intersection.

## Finding a Location Using Coordinates

You can find a location using latitude and longitude coordinates.

- 1 Select **Where To? > Coordinates**.
- 2 If necessary, select  and change the coordinate format or datum.
- 3 Enter the latitude and longitude coordinates.
- 4 Select **View on Map**.

## Foursquare

Foursquare is a location-based social network. Your device includes millions of pre-loaded Foursquare points of interest, which are indicated by the Foursquare logo in your location search results.

You can connect to your Foursquare account using the Garmin Drive app on your compatible smartphone. This allows you to view Foursquare location details, check in to a location, and search for points of interest in the online Foursquare database.

## Connecting to Your Foursquare Account

Before you can use this feature, your device must be connected to a supported phone running the Garmin Drive app ([Pairing with Your Smartphone, page 31](#)).

- 1 On your smartphone, open the Garmin Drive app.
- 2 Select  > **Foursquare**.
- 3 Enter your Foursquare login information.

## Searching Foursquare Points of Interest

You can search for Foursquare points of interest loaded on your device. While your device is connected to your Foursquare account using the Garmin Drive app, the search provides the most up-to-date results from the online Foursquare database and customized results from your Foursquare user account ([Connecting to Your Foursquare Account, page 23](#)).

Select **Where To? > Foursquare**.

## Viewing Foursquare Location Details

Before you can use this feature, your device must be connected to your Foursquare account using the Garmin Drive app ([Connecting to Your Foursquare Account, page 23](#)).

You can view detailed Foursquare location information, such as user ratings, restaurant pricing information, and hours of operation.

- 1 From the location search results, select a Foursquare point of interest.
- 2 Select .

## TripAdvisor

Your device includes TripAdvisor points of interest and ratings. TripAdvisor ratings appear automatically in the search results list for applicable points of interest. You can also search for nearby TripAdvisor points of interest and sort by distance or popularity.

## Finding TripAdvisor Points of Interest

- 1 Select **Where To? > TripAdvisor**.
- 2 Select a category.  
A list of nearby TripAdvisor points of interest for the category appears.
- 3 Select **Sort Results** to sort the search results by distance or popularity (optional).

## Viewing Recently Found Locations

Your device stores a history of the last 50 locations you have found.

Select **Where To? > Recent**.

## Clearing the List of Recently Found Locations

Select **Where To?** > **Recent** >  > **Clear** > **Yes**.

## Viewing Current Location Information

You can use the Where Am I? page to view information about your current location. This feature is helpful if you need to tell emergency personnel your location.

From the map, select the vehicle.

## Finding Emergency Services and Fuel

You can use the Where Am I? page to find the nearest hospitals, police stations, and fuel stations.

1 From the map, select the vehicle.

2 Select **Hospitals**, **Police Stations**, **Fuel**, or **Roadside Assist**.

**NOTE:** Some service categories are not available in all areas.

A list of locations for the selected service appears, with the nearest locations at the top.

3 Select a location.

4 Select an option:

- To navigate to the location, select **Go!**.
- To view the phone number and other location details, select .

## Getting Directions to Your Current Location

If you need to tell another person how to get to your current location, your device can give you a list of directions.

1 From the map, select the vehicle.

2 Select  > **Directions to Me**.

3 Select a starting location.

4 Select **Select**.

## Adding a Shortcut

You can add shortcuts to the Where To? menu. A shortcut can point to a location, a category, or a search tool.

The Where To? menu can contain up to 36 shortcut icons.

1 Select **Where To?** > **Add Shortcut**.

2 Select an item.

## Removing a Shortcut

1 Select **Where To?** >  > **Remove Shortcut(s)**.

2 Select a shortcut to remove.

3 Select the shortcut again to confirm.

4 Select **Done**.

## Saving Locations

### Saving a Location

1 Search for a location (*Finding a Location by Category*, page 20).

2 From the search results, select a location.

3 Select  > **Save**.

4 Enter a name, and select **Done**.

## Saving Your Current Location

- 1 From the map, select the vehicle icon.
- 2 Select **Save**.
- 3 Enter a name, and select **Done**.
- 4 Select **OK**.

## Editing a Saved Location

- 1 Select **Where To? > Saved**.
- 2 If necessary, select a category.
- 3 Select a location.
- 4 Select **i**.
- 5 Select **≡ > Edit**.
- 6 Select an option:
  - Select **Name**.
  - Select **Phone Number**.
  - Select **Categories** to assign categories to the saved location.
  - Select **Change Map Symbol** to change the symbol used to mark the saved location on a map.
- 7 Edit the information.
- 8 Select **Done**.

## Assigning Categories to a Saved Location

You can add custom categories to organize your saved locations.

**NOTE:** Categories appear in the saved locations menu after you have saved at least 12 locations.

- 1 Select **Where To? > Saved**.
- 2 Select a location.
- 3 Select **i**.
- 4 Select **≡ > Edit > Categories**.
- 5 Enter one or more category names, separated by commas.
- 6 If necessary, select a suggested category.
- 7 Select **Done**.

## Deleting a Saved Location

**NOTE:** Deleted locations cannot be recovered.

- 1 Select **Where To? > Saved**.
- 2 Select **≡ > Delete Saved Places**.
- 3 Select the box next to the saved locations to delete, and select **Delete**.



# Using the Map

You can use the map to navigate a route ([Your Route on the Map, page 13](#)) or to view a map of your surroundings when no route is active.

- 1 Select **View Map**.
- 2 Touch anywhere on the map.
- 3 Select an option:
  - Drag the map to pan left, right, up, or down.
  - To zoom in or out, select **+** or **-**.
  - To switch between North Up and 3-D views, select **▲**.
  - To start a route, select a location on the map, and select **Go!** ([Starting a Route by Using the Map, page 12](#)).

## Map Tools

Map tools provide quick access to information and device functions while you view the map. When you activate a map tool, it appears in a panel at the edge of the map.

**Stop:** Stops navigation of the active route.

**Edit Route:** Allows you to take a detour or skip locations in your route ([Changing Your Active Route, page 15](#)).

**Volume:** Allows you to customize the sound and notification settings ([Sound and Notification Settings, page 48](#)).

**Cities Ahead:** Shows upcoming cities and services along your active route or along a highway ([Cities Ahead, page 27](#)).

**Up Ahead:** Shows upcoming locations along the route or the road on which you are traveling ([Up Ahead, page 26](#)).

**Elevation:** Displays elevation changes ahead.

**Traffic:** Displays traffic conditions along your route or in your area ([Viewing Upcoming Traffic, page 29](#)). This feature is not available in all areas or for all device models.

**Trip Data:** Displays customizable trip data, such as speed or mileage ([Viewing Trip Data from the Map, page 29](#)).

**Turns:** Displays a list of upcoming turns in your route ([Viewing Turns and Directions, page 14](#)).

**Phone:** Displays a list of recent phone calls from your connected phone, and displays in-call options while a phone call is active ([Using In-Call Options, page 32](#)).

**Weather:** Displays weather conditions for your area.

**Report Camera:** Allows you to report a speed or red light camera. This tool is available only when you have speed or red light camera data on your device and you have an active connection to the Garmin Drive app.

## Viewing a Map Tool

- 1 From the map, select **⋮**.
- 2 Select a map tool.  
The map tool appears in a panel at the edge of the map.
- 3 When you are done using the map tool, select **✕**.

## Up Ahead

The Up Ahead tool provides information about upcoming locations along your route or the road on which you are traveling. You can view upcoming points of interest by category, such as restaurants, fuel stations, or rest areas.

You can customize the categories that show in the Up Ahead tool.

## Viewing Upcoming Locations



- 1 From the map, select  > **Up Ahead**.

While you are traveling, the map tool shows the next location along your road or route in each of the three categories. While you are not traveling, the map tool shows the three category names.

- 2 Select an option:
  - If the map tool shows categories, select a category to view a list of nearby locations in that category.
  - If the map tool shows upcoming locations, select a location to view location details or start a route to the location.

## Customizing the Up Ahead Categories

You can change the location categories that appear in the Up Ahead tool.

- 1 From the map, select  > **Up Ahead**.
- 2 Select a category.
- 3 Select .
- 4 Select an option:
  - To move a category up or down in the list, select and drag the arrow next to the category name.
  - To change a category, select the category.
  - To create a custom category, select a category, select **Custom Search**, and enter the name of a business or category.
- 5 Select **Save**.

## Cities Ahead

While you are traveling on a highway or navigating a route that includes a highway, the Cities Ahead tool provides information about upcoming cities along the highway. For each city, the map tool shows the distance to the highway exit and the services available, similar to the information on highway road signs.

## Viewing Upcoming Cities and Exit Services

- 1 From the map, select  > **Cities Ahead**.

While you are traveling along a highway or an active route, the map tool shows information about upcoming cities and exits.
- 2 Select a city.

The device shows a list of points of interest located at the selected city exit, such as fuel stations, lodging, or restaurants.
- 3 Select a location, and select **Go!** to start navigating.















## Warning and Alert Symbols

### **WARNING**







Entering your vehicle profile characteristics does not guarantee that your vehicle's characteristics will be accounted for in all route suggestions or that you will receive the warning icons in all cases. Limitations may exist in the map data such that your device cannot account for these restrictions or road conditions in all cases. Always defer to all posted road signs and road conditions when making driving decisions.

Warning and alert symbols may appear on the map or in route directions to alert you to potential hazards and road conditions.



## Restriction Warnings

	Height
	Weight
	Length
	Width
	Trailer height
	Trailer weight
	Trailer length
	Trailer width
	No boat trailers allowed
	No campers allowed
	No trailers allowed
	No propane
	No left turn
	No right turn
	No U turn

## Road Condition Warnings

	Risk of grounding
	Lateral wind
	Narrow road
	Sharp curve
	Steep down hill
	Tree overhang

## Alerts

	Weigh station
	Road not verified for motorhomes

## Trip Information

### Viewing Trip Data from the Map

From the map, select  > **Trip Data**.

### Customizing the Trip Data Fields

- 1 From the map, select  > **Trip Data**.
- 2 Select a trip data field.
- 3 Select an option.

The new trip data field appears in the trip data map tool.

### Viewing the Trip Log

Your device keeps a trip log, which is a record of the path you have traveled.

- 1 Select **Settings > Map and Vehicle > Map Layers**.
- 2 Select the **Trip Log** check box.

### Resetting Trip Information

- 1 From the map, select **Speed**.
- 2 Select a trip information data field.
- 3 Select  > **Reset Field(s)**.
- 4 Select an option:
  - When not navigating a route, select **Select All** to reset every data field except the speedometer, on the first page.
  - Select **Reset Overall Data** to reset Trip A and total data.
  - Select **Reset Max. Speed** to reset the maximum speed.
  - Select **Reset Trip B** to reset the odometer.

### Viewing Upcoming Traffic

Before you can use this feature, your device must be receiving traffic data ([Traffic, page 34](#)).



You can view traffic incidents coming up along your route or along the road on which you are traveling.

- 1 While navigating a route, select  > **Traffic**.



The nearest upcoming traffic incident appears in a panel on the right side of the map.
- 2 Select the traffic incident to view additional details.

### Viewing Traffic on the Map

The traffic map shows color-coded traffic flow and delays on nearby roads.

- 1 From the main menu, select  > **Navigation > Traffic**.
- 2 If necessary, select  > **Legend** to view the legend for the traffic map.

## Searching for Traffic Incidents

- 1 From the main menu, select  > **Navigation** > **Traffic**.
- 2 Select  > **Incidents**.
- 3 Select an item in the list.
- 4 If there is more than one incident, use the arrows to view additional incidents.

## Customizing the Map

### Customizing the Map Layers

You can customize which data appear on the map, such as icons for points of interest and road conditions.

- 1 Select **Settings** > **Map and Vehicle** > **Map Layers**.
- 2 Select the layers to include on the map, and select **OK**.

### Changing the Map Data Field

- 1 From the map, select a data field.  
**NOTE:** You cannot customize Speed.
- 2 Select a type of data to display.

### Changing the Map Perspective

- 1 Select **Settings** > **Map and Vehicle** > **Driving Map View**.
- 2 Select an option:
  - Select **Track Up** to display the map in two dimensions (2-D), with your direction of travel at the top.
  - Select **North Up** to display the map in 2-D with north at the top.
  - Select **3-D** to display the map in three dimensions.

## Live Services, Traffic, and Smartphone Features

The Garmin Drive app allows your device to receive smart notifications and live information, such as live traffic data and weather information.

**Live traffic data:** Sends real-time traffic data to your device, such as traffic incidents and delays, construction zones, and road closings ([Traffic, page 34](#)).

**Weather information:** Sends real-time weather forecasts, road conditions, and weather radar to your device ([Viewing the Weather Forecast, page 43](#)).

**Smart Notifications:** Displays phone notifications and messages on your device. This feature is not available for all languages.

**Hands-Free calling:** Allows you to place and receive phone calls using your device, and allows you to use the device as a hands-free speaker phone.

**Send locations to device:** Allows you to send locations from your smartphone to your navigation device.

**Foursquare check in:** Allows you to check in to Foursquare locations using your navigation device.

## Pairing with Your Smartphone

You can pair your RV / Camper device with your smartphone and the Garmin Drive app to enable additional features and access live information ([Live Services, Traffic, and Smartphone Features, page 30](#)).

- 1 From the app store on your smartphone, install the Garmin Drive app.
- 2 Turn on your RV / Camper device, and place the device and your smartphone within 3 m (10 ft.) of each other.
- 3 On your phone, open the Garmin Drive app.
- 4 Follow the on-screen instructions to sign in to a Garmin account and complete the pairing and setup process.

The main app dashboard appears. After the devices are paired, they connect automatically when they are turned on and within range.

### Tips After Pairing the Devices

- After the initial pairing, the two devices can connect automatically each time you turn them on.
- When you turn on the device, it tries to connect to the last phone to which it was connected.
- You might need to set your phone to connect to the device automatically when the device is turned on.
- You should verify the Bluetooth features you want to use are enabled ([Enabling or Disabling Bluetooth Features, page 33](#)).

### Pairing Additional Bluetooth Devices

- 1 Place your headset or phone and your Bluetooth device within 33 ft. (10 m) of each other.
- 2 On your device, enable Bluetooth wireless technology.
- 3 On your headset or phone, enable Bluetooth wireless technology and ensure it is visible to other Bluetooth devices.
- 4 On your device, select **Settings > Wireless Networks > Bluetooth**.  
A list of nearby Bluetooth devices appears.
- 5 Select your headset or phone from the list.
- 6 If necessary, select **Pair**.

## Going to an Address or Location Using the Garmin Drive App

You can use the Garmin Drive app to search for an address, business, or point of interest, and send it to your RV / Camper device for navigation.

- 1 From the Garmin Drive app, select **Where To?**
- 2 Select an option:
  - To search for an address near you, enter the house number and street name.
  - To search for an address in another city, enter the house number, street name, city, and state.
  - To search for a business name, enter all or part of the name.
  - To search for a city, enter the city and state.

As you type, suggestions appear below the search field.

- 3 Select a suggested search result.  
The app displays the location on a map.
- 4 Select **Go!** to start a route.

The RV / Camper device starts navigating to the selected location, and the location is added to your recent searches in the Where To? menu.

## Smart Notifications

While your device is connected to the Garmin Drive app, you can view notifications from your smartphone on your RV / Camper device, such as text messages, incoming calls, and calendar appointments.

## Receiving Notifications

### WARNING

Do not read or reply to notifications while driving. If you do so, you could become distracted by the display, which could lead to an accident causing serious personal injury or death.

Before you can use this feature, your device must be connected to a supported phone running the Garmin Drive app.

From most pages, a popup appears when the device receives a notification from your smartphone. If the device is moving, you must verify you are a passenger and not the driver before you can view notifications.

**NOTE:** If you are viewing the map, notifications appear in a map tool.

- To ignore a notification, select **OK**.  
The popup closes, but the notification remains active on your phone.
- To view a notification, select **View**.
- To listen to the notification, select **View > Play**.  
The device reads the notification using text-to-speech technology. This feature is not available for all languages.
- To perform additional actions, such as dismissing the notification from your phone, select **View**, and select an option.





**NOTE:** Additional actions are available for only some notification types and must be supported by the app generating the notification.

## Hands-Free Calling

**NOTE:** While most phones and headsets are supported and can be used, a particular phone or headset cannot be guaranteed to be compatible. All features may not be available for your phone.

Using Bluetooth wireless technology, your device can connect to your compatible mobile phone and wireless headset or helmet to become a hands-free device. To check compatibility, go to [www.garmin.com/bluetooth](http://www.garmin.com/bluetooth).

## Placing a Call

- 1 Select  > **Tools** > **Phone**.
- 2 Select an option:
  - To dial a number, select  enter the phone number, and select .
  - To view numbers of recent, missed, or recently dialed or received calls, select , select a log, and select a number to dial it.
  - To call a contact from your phone book, select , and select a contact.





## Receiving a Call

When you receive a call, select **Answer** or **Dismiss**.

## Using In-Call Options



In-call options appear when you answer a call. Some options may not be compatible with your phone.

**TIP:** If you close the in-call options page, you can open it again by selecting  from the main menu.

- To set up a conference call, select the caller ID, and select .
- To transfer audio to your phone, select .  
**TIP:** You can use this feature if you want to disconnect the Bluetooth connection and remain on the call, or if you need privacy.
- To use the dial pad, select the caller ID, and select .  
**TIP:** You can use this feature to use automated systems, such as voice mail.
- To mute the microphone, select .
- To hang up, select .

## Saving a Phone Number as a Preset

You can save up to three contacts as presets on the dial pad. This allows you to quickly call your home phone number, family members, or frequently called contacts.

- 1 Select  > **Tools** > **Phone**.
- 2 If necessary, select .
- 3 Select a preset number, such as **Preset 1**.
- 4 Select **OK**, then select a contact.

## Wireless Headsets

Your device can send audio navigation prompts to a Bluetooth enabled wireless headset.

## Enabling or Disabling Bluetooth Features

You can enable or disable hands-free calling and Garmin Drive features for your paired smartphone.

- 1 Select **Settings** > **Wireless Networks** > **Bluetooth**.
- 2 Select  next to your phone name.
- 3 In the **Use for** section, select an option:
  - To enable a connection to the Garmin Drive app, select **Garmin Drive**.
  - To enable hands-free calling features, select **Hands-Free**.
- 4 Select **OK**.



## Showing or Hiding App Notifications (Android™)

You can use the Garmin Drive app to customize which types of smartphone notifications appear on your RV / Camper device.

- 1 On your phone, open the Garmin Drive app.
- 2 Select  > **Smart Notifications**.  
A list of smartphone app categories appears.
- 3 Select a category to enable or disable notifications for that type of app.

## Showing or Hiding Notification Categories for Your Apple® Device

If you are connected to an Apple device, you can filter the notifications shown on your RV / Camper device by showing or hiding categories.

- 1 Select  > **Tools** > **Smart Notifications** > .
- 2 Select the check box next to each notification to show.

## Disconnecting a Bluetooth Device

You can temporarily disconnect a Bluetooth device without deleting it from the paired devices list. The Bluetooth device can connect to your RV / Camper device automatically in the future.

- 1 Select **Settings** > **Wireless Networks** > **Bluetooth**.
- 2 Select the device to disconnect.
- 3 Select **OK**.

## Deleting a Paired Bluetooth Device

You can delete a paired Bluetooth device to prevent it from automatically connecting to your RV / Camper device in the future. Deleting a paired smartphone also deletes all synced phonebook contacts and call history from your RV / Camper device.

- 1 Select **Settings** > **Wireless Networks** > **Bluetooth**.
- 2 Next to the Bluetooth device name, select  > **Forget**.

# Traffic

## NOTICE

Garmin is not responsible for the accuracy or timeliness of the traffic information.

Your device can provide information about traffic on the road ahead or on your route. You can set your device to avoid traffic when calculating routes, and to find a new route to your destination if a large traffic delay occurs on your active route (*Traffic Settings*, page 48). The traffic map allows you to browse the map for traffic delays in your area.

To provide traffic information, your device must be receiving traffic data.

- All product models can receive subscription-free traffic data using the Garmin Drive app (*Receiving Traffic Data Using Your Smartphone*, page 34).
- All product models can receive traffic data using an over-the-air traffic receiver accessory (*Receiving Traffic Data Using a Traffic Receiver*, page 34). Go to your product page at [garmin.com](http://garmin.com) to find and purchase a compatible traffic receiver accessory.

Traffic data is not available in all areas. For information about traffic coverage areas, go to [garmin.com/traffic](http://garmin.com/traffic).

## Receiving Traffic Data Using Your Smartphone

Your device can receive subscription-free traffic data while connected to a smartphone running the Garmin Drive app.

- 1 Connect your device to the Garmin Drive app.
- 2 On your RV / Camper device, select **Settings** > **Traffic** > **Traffic**, and verify the **Garmin Live Traffic** option is selected.

## Receiving Traffic Data Using a Traffic Receiver

### NOTICE

Heated (metallized) windshields could degrade the performance of the traffic receiver.

A traffic receiver receives traffic data from an over-the-air broadcast signal, where available. To receive over-the-air traffic data, the device must be connected to vehicle power using a traffic-compatible powered mount. A traffic receiver is included with some product models (*Traffic*, page 34). If your product model does not include a traffic receiver, you can go to your product page at [garmin.com](http://garmin.com) to find and purchase a compatible traffic receiver accessory.

Traffic data is not available in all areas. For information about traffic coverage areas, go to [garmin.com/traffic](http://garmin.com/traffic).



- 1 Connect the device to vehicle power using the traffic-compatible powered mount (*Mounting and Powering the Device in Your Vehicle*, page 3).

If your product model includes traffic data, the powered mount included with your device is traffic compatible. If you purchased a traffic receiver as an accessory, you should use the accessory to connect the device to vehicle power.



- 2 Select **Settings** > **Traffic** > **Traffic**, and verify the **Traffic Accessory** option is selected.

## Viewing Traffic on the Map

The traffic map shows color-coded traffic flow and delays on nearby roads.

- 1 From the main menu, select  > **Navigation** > **Traffic**.
- 2 If necessary, select  > **Legend** to view the legend for the traffic map.

## Searching for Traffic Incidents

- 1 From the main menu, select  > **Navigation** > **Traffic**.
- 2 Select  > **Incidents**.
- 3 Select an item in the list.
- 4 If there is more than one incident, use the arrows to view additional incidents.

# Voice Command

**NOTE:** Voice command is not available for all languages and regions, and may not be available on all models.

**NOTE:** Voice Activated Navigation may not achieve desired performance when in a noisy environment.

Voice command allows you to use your device by saying words and commands. The voice command menu provides voice prompts and a list of available commands.

## Tips for Speaking to the Device

- Speak in a clear voice directed at the device.
- Start each request with *OK, Garmin*.
- Reduce background noise, such as voices or the radio, to help the device interpret your commands more accurately.
- Respond to voice prompts from the device as needed.
- If you do not receive a useful response, try rephrasing your request.
- If the device does not respond to your requests, verify it is not placed near a speaker or air vent, which can produce noise that interferes with the microphone.

## Launching Garmin Voice-Activated Navigation

Garmin voice-activated navigation allows you to use plain language spoken requests to search for locations and addresses, start routes with turn-by-turn directions, place hands-free phone calls, and more.

- Say *OK, Garmin*, and make a spoken request.  
For example, you can say phrases like these:
  - *OK, Garmin, take me home.*
  - *OK, Garmin, where's the library?*

## Checking Your Arrival Time

While a route is active, you can say a phrase to check your estimated time of arrival at your destination.

Say *OK, Garmin, what time will we arrive?*.

## Placing a Phone Call Using Your Voice

You can use a voice command to call to a contact from the phone book of your paired smartphone.

Say *OK, Garmin, call*, and say the contact name.  
For example, you can say *OK, Garmin, call Mom..*

## Changing Device Settings Using Your Voice



You can say phrases like these to set device settings to a value from 0 to 10.

- *OK, Garmin, increase the volume.*
- *OK, Garmin, set the volume to 0.*
- *OK, Garmin, set the volume to 9.*

# Using the Apps

## Viewing the Owner's Manual on Your Device

You can view the complete owner's manual on the device screen in many languages.

- 1 Select  > **Tools** > **Owner's Manual**.  
The owner's manual appears in the same language as the software text ([Setting the Text Language, page 49](#)).
- 2 Select  to search the owner's manual (optional).

## Trip Planner





You can use the trip planner to create and save a trip, which you can navigate later. This can be useful for planning a delivery route, a vacation, or a road trip. You can edit a saved trip to further customize it, including reordering locations, optimizing the order of stops, adding suggested attractions, and adding shaping points. You can also use the trip planner to edit and save your active route.

### Planning a Trip

A trip can include many destinations, and it must include at least a starting location and one destination. The starting location is the location from which you plan to start your trip. If you start navigating the trip from a different location, the device gives you the option to route to your starting location first. For a round trip, the starting location and final destination can be the same.

- 1 Select  > **Navigation** > **Trip Planner** > **New Trip**.
- 2 Select **Select Start Location**.
- 3 Choose a location for your starting point, and select **Select**.
- 4 Select **Select Destination**.
- 5 Choose a location for a destination, and select **Select**.
- 6 Select **Add Location** to add more locations (optional).
- 7 After you have added all the necessary locations, select **Next** > **Save**.
- 8 Enter a name, and select **Done**.

### Editing and Reordering Locations in a Trip

- 1 Select  > **Navigation** > **Trip Planner** > **Saved Trips**.
- 2 Select a saved trip.
- 3 Select a location.
- 4 Select an option:
  - To move the location up or down, select , and drag the location to a new position in the trip.
  - To add a new location after the selected location, select .
  - To remove the location, select .

### Optimizing the Order of Destinations in a Trip

The device can automatically optimize the order of destinations in your trip to create a shorter, more efficient route. The starting location and final destination are not changed when you optimize the order.

While editing a trip, select  > **Optimize Order**.



### Discovering Attractions Along Your Trip

The device can suggest interesting or popular attractions to add to your trip.

- 1 While editing a trip, select  > **Suggest Attractions**.
- 2 Select an attraction to view more information.
- 3 Select **Select** to add the attraction to your trip.

## Changing Routing Options for a Trip

You can customize how the device calculates the route when you start your trip.

- 1 Select  > **Navigation** > **Trip Planner** > **Saved Trips**.
- 2 Select a saved trip.
- 3 Select .
- 4 Select an option:
  - To add shaping points to your trip, select **Shape Route**, and follow the on-screen instructions ([Shaping Your Route, page 15](#)).
  - To change the calculation mode for the trip, select **Route Preference** ([Changing the Route Calculation Mode, page 16](#)).

## Navigating to a Saved Trip

- 1 Select  > **Navigation** > **Trip Planner** > **Saved Trips**.
- 2 Select a saved trip.
- 3 Select **Go!**.
- 4 Select the first location to navigate to, and select **Start**.

The device calculates a route from your current location to the selected location, and then it guides you to the remaining trip destinations in order.

## Editing and Saving Your Active Route

If a route is active, you can use the trip planner to edit and save your route as a trip.

- 1 Select  > **Navigation** > **Trip Planner** > **Saved Trips** > **My Active Route**.
- 2 Edit your route using any of the trip planner features.

The route recalculates each time you make a change.
- 3 Select **Save** to save your route as a trip, which you can navigate again later (optional).

## TracBack

### Following Your Recent Track

The TracBack feature records the most recent segment of your movement. You can retrace your recent track back to a previous location.

- 1 Select  > **Navigation** > **TracBack**.

Your recent track appears on the map.
- 2 Select **Go!**.

### Saving Your Recent Track as a Trip

You can save your recent track as a trip, which you can navigate later using the trip planner ([Navigating to a Saved Trip, page 37](#)).

- 1 Select **TracBack**.

Your recent track appears on the map.
- 2 Select  > **Save as Trip**.
- 3 Enter a name, and select **Done**.

## Fusion-Link™ Wireless Remote Control App

You can use the Fusion-Link remote control app on your RV / Camper device to control a compatible Fusion® stereo. You can adjust the volume, change the source, control playback, select and manage radio presets, adjust some stereo settings, and configure DSP profiles on the stereo.

The app communicates with the stereo using a wireless connection to the RV / Camper device. You must connect your device to the stereo using Bluetooth technology in order to use the app.

If you connect the stereo to a Wi-Fi network, the app can communicate with the stereo using that network, which provides a greater range than a Bluetooth connection.

### Connecting to a Stereo Using Bluetooth

- 1 Enable Bluetooth discoverable mode on your compatible Fusion stereo.
- 2 Turn on your RV / Camper device, and place the device within 10 m (33 ft.) of the stereo.
- 3 On your RV / Camper device, select **Settings > Wireless Networks > Bluetooth**.
- 4 Select your Fusion stereo from the list of available devices.

### Connecting to a Stereo Using a Wireless Network

You can connect your RV / Camper device to a compatible Fusion stereo that is connected to the same wireless network.

- 1 Select an option:
  - Connect your Fusion stereo to the vehicle's Ethernet or wireless network.
  - If your Fusion stereo has a built-in wireless network, enable wireless networks in the stereo settings.
- 2 On your RV / Camper device, select **Settings > Wireless Networks > Wi-Fi**.
- 3 Select the same wireless network to where your stereo is connected.
- 4 If necessary, enter a password.

## Music Playback

### Playing Music

- 1 Select  > **Tools > Fusion Link**.
- 2 Select a stereo from the list.
- 3 If necessary, select a song or station.







### Selecting a Source

- 1 Select the source icon.

The source icon is in the upper-left corner of the stereo screen, and it indicates the source that is currently selected.
- 2 Select a source.



## Playback Controls

The on-screen playback controls may change depending on the source selected.

	Select to pause media playback.
	Select to play media or resume media playback.
	<ul style="list-style-type: none"><li>• Select to skip to the previous track when using an applicable source.</li><li>• Hold to rewind the track when using an applicable source.</li><li>• AM or FM source:<ul style="list-style-type: none"><li>◦ Select to tune to the previous station or preset.</li><li>◦ Hold for faster tuning (manual mode only).</li></ul></li></ul>
	<ul style="list-style-type: none"><li>• Select to skip to the next track when using an applicable source.</li><li>• Hold to fast-forward the track when using an applicable source.</li><li>• AM or FM source:<ul style="list-style-type: none"><li>◦ Select to tune to the next station or preset.</li><li>◦ Hold for faster tuning (manual mode only).</li></ul></li></ul>
	Select to cycle through the tuning modes (auto or manual) and presets. Press and hold to save the current station as a preset.
	Select to increase the volume for the current zone.
	Select to decrease the volume for the current zone.
Gain	On the AUX source, move the slider to increase or decrease the gain.

## Audio Control

### Adjusting the Volume for a Zone

- 1 Select  > **Tools** > **Fusion Link** > .
- 2 Move the slider to control the volume for a zone.



### Muting all Connected Stereos

You can quickly mute the audio from this stereo or from all stereos connected to the network.

From any source, select .



The mute symbol appears and audio from this stereo is silenced.

### Adjusting the Tones

- 1 Select  > **Tools** > **Fusion Link** >  > **Music**.
- 2 Select a zone.
- 3 Select **Tone**.
- 4 Move the slider bar to adjust the level of each tone.

### Disabling the Loud Setting for a Zone

The Loud setting maintains frequency response at low volumes and increases perceived loudness at high volumes. This setting is enabled by default in all zones.

- 1 Select  > **Tools** > **Fusion Link** >  > **Music**.
- 2 Select a zone.
- 3 Select **Loud** to enable or disable the setting.

## Adjusting the Gain for an Auxiliary Device

You can adjust the gain for a connected auxiliary device to achieve a volume level similar to that of other media sources. You can adjust the gain in 1 dB increments.

- 1 Select an auxiliary source.
- 2 Move the slider to increase or decrease the gain.



**NOTE:** To achieve the best audio quality when using a portable media player with a headphone output, it may be necessary to adjust the volume control on the media player, instead of adjusting the gain.

## Speaker Zones

You can group speakers in one area into a speaker zone. This enables you to control the audio level of the zones individually. For example, you could make the audio quieter in the cabin and louder on deck.

You can set the balance, volume limit, tone, subwoofer level, subwoofer frequency, and name for each zone, and configure other zone-specific settings (*Speaker Zone Settings, page 41*).

## Adjusting the Audio Settings for a Zone

- 1 Select  > **Tools** > **Fusion Link** >  > **Music**.
- 2 Select a zone.
- 3 Select **More**.
- 4 Select one or more options:



**NOTE:** Not all options are available for all zones.

- To limit the maximum volume level of this zone, select **VOLUME LIMIT**, and adjust the level.
- To set the subwoofer level for this zone, select **SUB LEVEL**, and adjust the level.
- To adjust the right and left speaker balance of this zone, select **BALANCE**, and adjust the balance.

## Adjusting the Subwoofer Filter

You can use the subwoofer filter setting to control the subwoofer cutoff frequency for each zone, which can enhance the blend of the sound produced by the speakers and the subwoofer. Audio signals above the selected cutoff frequency are not passed to the subwoofer.

**NOTE:** If a DSP setting has been applied to the zone, this setting cannot be changed on the stereo. You can view the DSP setting for the optimal cutoff frequency as calculated by the DSP controller, but you cannot adjust it.

- 1 Select  > **Tools** > **Fusion Link** >  > **Music**.
- 2 Select a zone.
- 3 Select **Subwoofer Filter**.
- 4 Select a frequency.

## DSP Settings



Some Fusion stereos feature digital signal processing (DSP). You can select pre-configured DSP settings for Fusion speakers and amplifiers to optimize audio quality.

All DSP settings are configured using the Fusion-Link remote control app.

**NOTE:** This feature is not available for all stereo models.

## Configuring the DSP Settings

You can configure the DSP settings to optimize the sound in each zone that uses Fusion speakers and amplifiers.

- 1 Select  > **Tools** > **Fusion Link** >  > **Music**.
- 2 Select a zone.
- 3 Select **DSP Settings**.
- 4 Configure the DSP settings as needed, depending on the models of the Fusion speakers and amplifiers connected to the zone.
- 5 Repeat these steps for each zone.
- 6 After you have finished configuring the DSP settings for all of the zones, select **Send DSP Settings**.

## Presets

You can save your favorite AM stations and FM stations as presets for easy access.



### Saving a Station as a Preset

- 1 With an applicable source selected, tune the stereo to a station or a channel.
- 2 Press and hold .

### Selecting a Preset from a List

- 1 With an applicable source selected, select .
- 2 Select a preset.

### Removing Presets

- 1 With an applicable source selected, select .
- 2 Select .
- 3 Select each preset you want to remove.
- 4 After you have finished removing presets, select .

## Audio Settings

Select  > **Tools** > **Fusion Link** > .

**Music:** Enables you to configure the speaker zones ([Speaker Zone Settings, page 41](#)).

**Tuner Region:** Sets the region used by the various radio sources.

**Device Name:** Sets a name for this stereo.

**Searching:** Enables Fusion Alpha Search Technology (FAST), which allows you to quickly search for tracks by letter or number. You can set the minimum number of tracks required to enable the FAST menu. FAST searching is available when your device contains more than this number of tracks.



**Update:** Allows you to update the stereo and DSP settings software.

**About:** Shows the software version information for the stereo.

## Speaker Zone Settings

### Setting a Zone Name

You can set a name for a speaker zone to make it easier to identify.

- 1 Select  > **Tools** > **Fusion Link** >  > **Music**.
- 2 Select a zone.
- 3 Select **Zone Name**.
- 4 Use the on-screen keyboard to enter a name, and select **OK**.

## Linking Zones



You can link zones 1 and 2 to keep the volume levels synchronized. Adjusting the volume of either of the linked zones affects both zones.

Select  > **Tools** > **Fusion Link** >  > **Music** > **Zone 2** > **Link to zone 1**.

**NOTE:** After zones 1 and 2 are linked, you cannot adjust the volume of each zone individually.

## Disabling a Zone

You can disable an unused zone and remove it from the audio level pages. When a zone is disabled, you cannot change any of the settings for that zone. You can disable zones 3 and 4 only.

- 1 Select  > **Tools** > **Fusion Link** >  > **Music**.
- 2 Select a zone.
- 3 Select **Zone Enabled**.

## Disabling the Internal Amplifiers

If you do not connect speakers directly to zones 1 and 2, you can disable the internal amplifiers to reduce power consumption.



- 1 Select  > **Tools** > **Fusion Link** >  > **General**.
- 2 Select **Internal Amplifiers**.

## Logging Service History

You can log the date and odometer reading when service or maintenance is performed on your vehicle. The device provides several service categories, and you can add custom categories ([Adding Service Categories, page 42](#)).



- 1 Select  > **Tools** > **Service History**.
- 2 Select a service category.
- 3 Select **Add Record**.
- 4 Enter the odometer reading, and select **Next**.
- 5 Enter a comment (optional).
- 6 Select **Done**.

## Adding Service Categories



- 1 Select  > **Tools** > **Service History**.
- 2 Select  > **Add Category**.
- 3 Enter a category name, and select **Done**.

## Deleting Service Categories

When you delete a service category, all service records in the category are also deleted.

- 1 Select  > **Tools** > **Service History**.
- 2 Select  > **Delete Categories**.
- 3 Select the service categories to delete.
- 4 Select **Delete**.

## Renaming Service Categories



- 1 Select  > **Tools** > **Service History**.
- 2 Select the category to be renamed.
- 3 Select  > **Rename Category**.
- 4 Enter a name, and select **Done**.

## Editing a Service Record

You can edit the comment, odometer reading, and date of a service record.

- 1 Select  > **Tools** > **Service History**.
- 2 Select a category.
- 3 Select a field.
- 4 Enter the new information, and select **Done**.

## Deleting Service Records

- 1 Select  > **Tools** > **Service History**.
- 2 Select a service category.
- 3 Select  > **Delete Records**.
- 4 Select the service records to be deleted.
- 5 Select **Delete**.

## Viewing Previous Routes and Destinations

Before you can use this feature, you must enable the travel history feature ([Device Settings, page 49](#)).

You can view your previous routes and places you have stopped on the map.

Select  > **Navigation** > **Trip History**.

## Viewing the Weather Forecast

Before you can use this feature, your device must be receiving weather data. You can connect your device to the Garmin Drive app to receive weather data.



- 1 From the home screen, select the weather widget ([Home Screen, page 7](#)).  
The device shows the current weather conditions and a forecast for the next several days.
- 2 Select a day.  
The detailed forecast for that day appears.

## Viewing Weather Near a Different City

- 1 From the home screen, select the weather widget ([Home Screen, page 7](#)).
- 2 Select **Current Location**.
- 3 Select an option:
  - To view weather for a favorite city, select a city in the list.
  - To add a favorite city, select **Add City**, and enter a city name.

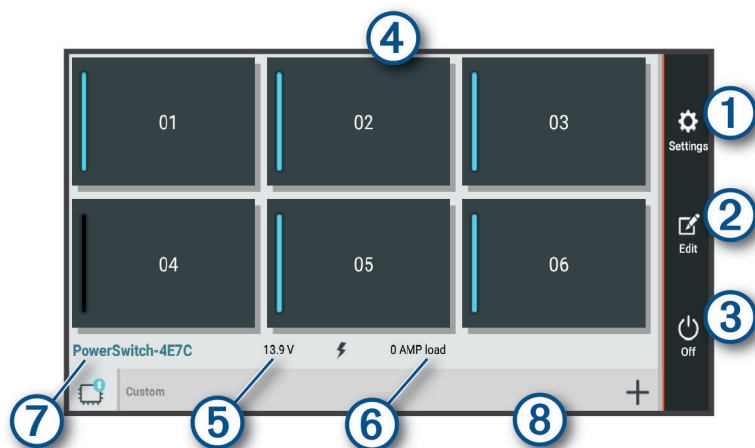
## Garmin PowerSwitch™ App



① 	Opens the app settings menu
② 	Enters editing mode to customize the app layout and functions
③ 	Turns off all outputs
④ Power buttons	Activates each connected output
⑤	Displays input voltage
⑥	Displays the total amperage of the selected Garmin PowerSwitch device
⑦	Displays the device name
⑧	Displays Garmin PowerSwitch device tabs and custom layout tabs

### Activating a Power Switch



Before you can use the Garmin PowerSwitch app to activate a switch, you must install your Garmin PowerSwitch device in your vehicle and pair it with the Garmin PowerSwitch app.

From the Garmin PowerSwitch app, select a power button to turn a switch on or off.

### Turning Off All Switches

Select .

## Customizing a Button

- 1 From the Garmin PowerSwitch app screen, select .  
The app enters editing mode.
- 2 Select  on the button you want to customize.
- 3 Select an option:
  - To change the name of the button, select the **Button Label** field, and enter a name.
  - To add an icon to the button, select the **Icon** field, and select an icon.
  - To change the button color, select a color.
  - To change the button mode, select a button mode.
  - To adjust the intensity of the switch, use the slider.
  - To set the button to activate with a control input, select a control input.
- 4 Select .
- 5 Select **Done**.

## Assigning a Switch to a Control Input



Before you can use control input functions, you must connect a control input to your Garmin PowerSwitch device ([Connecting a Control Input, page 59](#)).

You can assign one or more switches to turn on when the Garmin PowerSwitch device receives a signal from a control input.



- 1 Select .
- 2 Select your Garmin PowerSwitch device.
- 3 Select a control input.
- 4 Select one or more switches.

## Adding a Custom Layout



You can add a custom layout tab to the Garmin PowerSwitch app. Buttons added to a custom layout can control multiple switches at the same time.

- 1 From the Garmin PowerSwitch app, select .  
The device enters editing mode.
- 2 Select .



## Adding a Button to a Custom Layout

- 1 From the Garmin PowerSwitch app, select a custom layout tab.
- 2 Select .  
The app enters editing mode.
- 3 Select **Add Button**.
- 4 On the new button, select .
- 5 Select an option:
  - To change the name of the button, select the **Button Label** field, and enter a name.
  - To add an icon to the button, select the **Icon** field, and select an icon.
  - To change the button color, select a color.
- 6 Select **Add Action**.
- 7 If necessary, select a Garmin PowerSwitch device and a switch.
- 8 Select an action:
  - To set the button to turn the switch on or off with each press, select **Toggle**.
  - To set the button to turn on the switch, select **Turn On**.
  - To set the button to turn off the switch, select **Turn Off**.
- 9 Select a button mode:
  - To set the button to activate with one touch, select **Normal**.
  - To set the button to activate only while touching the button, select **Momentary**.
  - To set the button to turn on and off repeatedly, select **Strobe**, and select time intervals.
- 10 If applicable, use the slider to set the brightness of lights.
- 11 Select .
- 12 If necessary, select **Add Action** to add additional actions for the button.  
You can add one action for every switch on the Garmin PowerSwitch device.

## Arranging Buttons In a Custom Layout

- 1 From the Garmin PowerSwitch app, select a custom layout tab.
- 2 Select .  
The app enters editing mode.
- 3 On the button you want to move, hold , and drag the button to a new location.

## Deleting a Custom Layout or Button

- 1 From the Garmin PowerSwitch app, select a custom layout tab.
- 2 Select .  
The app enters editing mode.
- 3 Select an option:
  - To delete a button, select  on the button you want to delete.
  - To delete a layout tab, select  on the layout tab.

# Settings

## Navigation Settings

Select **Settings > Navigation**.

**Calculation Mode:** Sets the route calculation method.

**Avoidances:** Sets road features to avoid on a route.

**Custom Avoidances:** Allows you to avoid specific roads or areas.

**Environmental Zones:** Sets the avoidance preferences for areas with environmental or emissions restrictions that may apply to your vehicle.

**Toll Roads:** Sets the preferences for avoiding toll roads.

**Tolls and Fees:** Sets the preferences for avoiding toll roads and toll stickers.

**NOTE:** This feature is not available in all areas.

**Restricted Mode:** Disables all functions that require significant operator attention.

**Travel History:** Allows the device to store a record of the places you go. This allows you to view the trip log, use the Trip History feature, and use myTrends suggested routes.

**Clear Travel History:** Allows you to clear all travel history from the device.

## Map and Vehicle Settings

Select **Settings > Map and Vehicle**.

**Vehicle:** Sets the vehicle icon that represents your position on the map.

**Voice Language:** Sets the language for navigation voice prompts.

**Driving Map View:** Sets the perspective on the map.

**Map Detail:** Sets the level of detail on the map. More detail may cause the map to draw slower.

**Map Theme:** Changes the color of the map data.

**Map Layers:** Sets the data that appears on the map page (*Customizing the Map Layers, page 30*).

**Auto Zoom:** Automatically selects the zoom level for optimal use of your map. When disabled, you must zoom in or out manually.

**myMaps:** Sets which installed maps the device uses.

## Enabling Maps

You can enable map products installed on your device.

**TIP:** To purchase additional map products, go to [garmin.com/maps](http://garmin.com/maps).

- 1 Select **Settings > Map and Vehicle > myMaps**.
- 2 Select a map.

## Connecting to a Wireless Network

- 1 Select **Settings > Wireless Networks > Wi-Fi**.
- 2 If necessary, select the toggle switch to turn on wireless network technology.
- 3 Select a wireless network.
- 4 If necessary, enter the encryption key.

The device connects to the wireless network. The device remembers the network information and connects automatically when you return to this location in the future.

## Enabling Bluetooth Wireless Technology

Select **Settings > Wireless Networks > Bluetooth**.

## Driver Assistance Settings

Select **Settings > Driver Assistance**.

**Audible Driver Alerts:** Enables an audible alert for each type of driver alert (*Driver Awareness Features and Alerts, page 11*).

**Proximity Alerts:** Alerts you when you approach speed cameras or red light cameras.

**Route Preview:** Shows a preview of the major roads in your route when you start navigation.

**Break Planning:** Reminds you to take a break and shows upcoming services after you drive for an extended time. You can enable or disable break reminders and upcoming service suggestions.

## Traffic Settings

From the main menu, select **Settings > Traffic**.

**Traffic:** Enables the traffic feature.

**Current Provider:** Sets the traffic provider to use for traffic data. The Auto option selects the best available traffic data automatically.

**Subscriptions:** Lists the current traffic subscriptions.

**Optimize Route:** Enables the device to use optimized alternate routes automatically or upon request (*Avoiding Traffic Delays on Your Route, page 16*).

## Display Settings

Select **Settings > Device > Display**.

**Brightness Level:** Sets the display brightness level on your device.

**Adaptive Brightness:** Automatically adjusts the backlight brightness based on the ambient light when the device is out of the mount.

**Theme:** Allows you to select day or night color mode. If you select the Automatic option, the device automatically switches to day or night colors based on the time of day.

**Wallpaper:** Sets the wallpaper background on your device.

**Sleep:** Allows you to set the amount of idle time before your device enters sleep mode while using battery power.

**Daydream:** Enables or disables the daydream screen saver.

**Font size:** Increases or decreases the font size on your device.

**When device is rotated:** Enables the screen to rotate automatically between portrait and landscape display modes based on the device orientation or remain in the current orientation.

## Sound and Notification Settings

Select **Settings > Device > Sound & Notification**.

**Volume Sliders:** Set the volume levels for navigation, media, calls, alarms, and notification alerts.

**Do not disturb:** Sets the rules for the automatic do-not-disturb feature. This feature allows you to disable audible alerts during specific times or events.

**Default notification ringtone:** Sets the default notification ringtone sound on your device.

**Other sounds:** Allows you to enable or disable sounds for other device interactions, such as screen touches, screen locking, or charging.

**Cast:** Allows you to wirelessly send the device audio or video to a compatible speaker, display, or device.

**When device is locked:** Sets whether notifications appear on the screen while the device is locked.

**App notifications:** Allows you to enable or disable notifications for each installed app and modify the do not disturb preferences for each app.



**Notification access:** Allows you to select which apps have access to read system and app notifications.

**Do not disturb access:** Allows you to select which apps can override or modify the do not disturb settings.

## Adjusting Sound and Notification Volume

- 1 Select **Settings > Device > Sound & Notification**.
- 2 Use the slider bars to adjust the sound and notification volume.

## Setting an Alarm

- 1 Select  > **Tools > Clock >  > **.
- 2 Set a time.
- 3 If necessary, select the toggle switch to turn on the alarm.

## Enabling or Disabling Location Services

The location services feature must be enabled for your device to find your location, calculate routes, and provide navigational assistance. You can disable location services to plan a route when GPS signals are not available. When location services are disabled, the device enables a GPS simulator to calculate and simulate routes.

**TIP:** Disabling location services can help save battery power.

- 1 Select **Settings > Personal > Location**.
- 2 Select the toggle switch to enable or disable location services.

**NOTE:** For most uses, you should not change the Mode setting from the default option of Device only. The device includes a high-performance GPS antenna that provides the most accurate location data while navigating.

## Setting the Text Language

You can select the language for text in the device software.

- 1 Select **Settings > Personal > Language & Input > Language**.
- 2 Select a language.

## Date and Time Settings

Select **Settings > System > Date & Time**.

**Automatic time zone:** Automatically sets the time zone based on information from the connected network.

**Select time zone:** Sets the time zone on your device when Automatic time zone is disabled.

**Use 24-hour format:** Enables or disables the 24-hour time format.

## Device Settings

Select **Settings > About Device**.

**Status:** Displays the system status and network information.

**Legal Information:** Allows you to view the end-user license agreement (EULA) and software license information.

**Regulatory information:** Displays e-label regulatory and compliance information.

**Garmin device information:** Displays hardware and software version information.

**Device Data Reporting:** Shares anonymous data to improve the device.

## Restoring Settings

You can restore a category of settings to the factory default values.

- 1 Select **Settings**.
- 2 Select a settings category.
- 3 Select  > **Restore**.

# Device Information

## Viewing E-label Regulatory and Compliance Information

- 1 From the settings menu, swipe to the bottom of the menu.
- 2 Select **About Device** > **Regulatory information**.

## Specifications

Operating temperature range	From -20° to 55°C (from -4° to 131°F)
Charging temperature range	From 0° to 45°C (from 32° to 113°F)
Radio frequency (RV 890 / Camper 890)	2.4 GHz @ 14 dBm
Radio frequency (RV 1090 / Camper 1090)	2.4 GHz @ 15 dBm
Power input	Vehicle power using the included vehicle power cable. AC power using an optional accessory (for home and office use only).
Battery type	Rechargeable lithium-ion

## Charging the Device

**NOTE:** This Class III product shall be powered by an LPS power supply.

You can charge the battery in the device using any of these methods.

- Install the device in the mount, and connect the mount to vehicle power.
- Connect the device to an optional power adapter accessory, such as a wall power adapter.  
You can purchase an approved Garmin AC-DC adapter suitable for home or office use from a Garmin dealer or [www.garmin.com](http://www.garmin.com). The device may charge slowly when connected to a third-party adapter.

## Device Maintenance

### Garmin Support Center

Go to [support.garmin.com](http://support.garmin.com) for help and information, such as product manuals, frequently asked questions, videos, and customer support.

## Updating Maps and Software Using a Wi-Fi Network

### NOTICE

Map and software updates may require the device to download large files. Regular data limits or charges from your internet service provider apply. Contact your internet service provider for more information about data limits or charges.

You can update the maps and software by connecting your device to a Wi-Fi network that provides access to the internet. This allows you to keep your device up to date without connecting it to a computer.

1 Using the included USB cable, connect the device to external power.

**NOTE:** A USB power adapter is not included. Go to the product page on [garmin.com](http://garmin.com) to purchase a power adapter accessory.

2 Connect the device to a Wi-Fi network (*Connecting to a Wireless Network*, page 47).

While connected to a Wi-Fi network, the device checks for available updates automatically and displays a notification when an update is available.

3 Select an option:

- When an update notification appears, swipe down from the top of the screen, and select **An update is available..**
- To manually check for updates, select **Settings > Updates.**

The device displays available map and software updates. When an update is available, **Update Available** appears below Map or Software.

4 Select an option:

- To install all available updates, select **Download.**
- To install only map updates, select **Map.**
- To install only software updates, select **Software.**

5 If necessary, read the license agreements, and select **Accept All** to accept the agreements.

**NOTE:** If you do not agree with the license terms, you can select **Reject.** This stops the update process. You cannot install updates until you accept the license agreements.

6 Keep the device connected to external power and within range of the Wi-Fi network until the update process is complete.

**TIP:** If a map update is interrupted or canceled before it completes, your device may be missing map data. To repair missing map data, you must update the maps again.

## Updating Maps and Software with Garmin Express

You can use the Garmin Express application to download and install the latest map and software updates for your device.

1 If you do not have the Garmin Express application installed on your computer, go to [garmin.com/express](http://garmin.com/express) and follow the on-screen instructions to install it (*Installing Garmin Express, page 53*).

2 Open the  Garmin Express application.

3 Connect your device to your computer using a micro-USB cable.

The small end of the cable connects to the micro-USB port  on your RV / Camper device, and the large end connects to an available USB port on your computer.

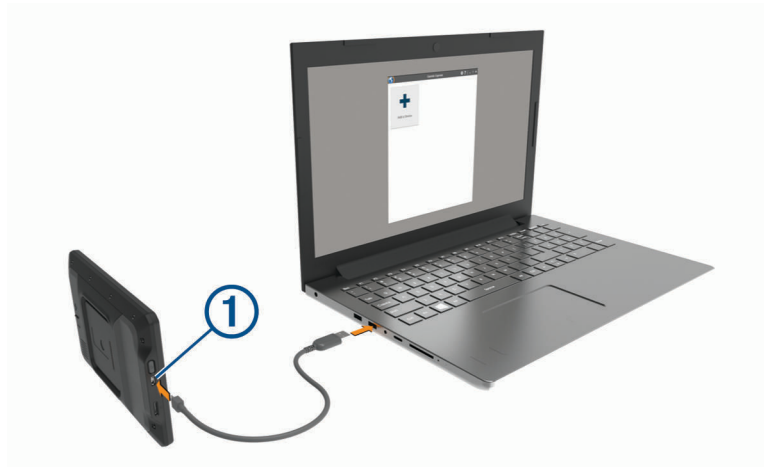

4 When your RV / Camper device prompts you to enter file transfer mode, select **Yes**.

5 In the Garmin Express application, click **Add a Device**.

The Garmin Express application searches for your device and displays the device name and serial number.

6 Click **Add Device**, and follow the on-screen instructions to add your device to the Garmin Express application.

When setup is complete, the Garmin Express application displays the updates available for your device.

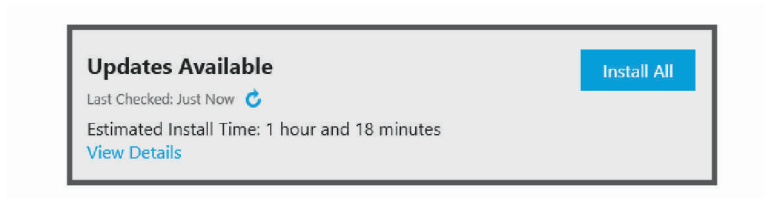

7 Select an option:

- To install all available updates, click **Install All**.
- To install a specific update, click **View Details**, and click **Install** next to the update you want.

The Garmin Express application downloads and installs the updates onto your device. Map updates are very large, and this process may take a long time on slower internet connections.

**NOTE:** If a map update is too large for the internal storage of the device, the software may prompt you to install a microSD® card in your device to add storage space (*Installing a Memory Card for Maps and Data, page 63*).

8 Follow the on-screen instructions during the update process to finish installing updates.

For example, during the update process, the Garmin Express application may instruct you to disconnect and reconnect your device.

## Installing Garmin Express

The Garmin Express application is available for Windows® and Mac® computers.

- 1 On your computer, go to [garmin.com/express](http://garmin.com/express).
- 2 Select an option:
  - To view the system requirements and verify the Garmin Express application is compatible with your computer, select **System Requirements**.
  - To install on a Windows computer, select **Download for Windows**.
  - To install on a Mac computer, select **Download for Mac**.
- 3 Open the downloaded file, and follow the on-screen instructions to complete the installation.

## Device Care

### NOTICE

Avoid dropping your device.

Do not store the device where prolonged exposure to extreme temperatures can occur, because it can cause permanent damage.

Never use a hard or sharp object to operate the touchscreen, or damage may result.

Do not expose the device to water.

## Cleaning the Outer Casing

### NOTICE

Avoid chemical cleaners and solvents that can damage plastic components.

- 1 Clean the outer casing of the device (not the touchscreen) using a cloth dampened with a mild detergent solution.
- 2 Wipe the device dry.

## Cleaning the Touchscreen

- 1 Use a soft, clean, lint-free cloth.
- 2 If necessary, lightly dampen the cloth with water.
- 3 If using a dampened cloth, turn off the device and disconnect the device from power.
- 4 Gently wipe the screen with the cloth.

## Avoiding Theft

- Remove the device and mount from sight when not in use.
- Remove the residue left on the windshield by the suction cup.
- Do not keep your unit in the glove compartment.
- Register your device using the Garmin Express software ([garmin.com/express](http://garmin.com/express)).

## Resetting the Device

You can reset your device if it stops functioning.

Hold the power key for 12 seconds.

## Removing the Device, Mount, and Suction Cup

### Removing the Mount from the Suction Cup

- 1 Loosen the nut that secures the magnetic powered mount to the suction cup ball.
- 2 Turn the device mount to the right or left.
- 3 Apply pressure until the socket on the mount releases the ball on the suction cup.

## Removing the Suction Cup from the Windshield

- 1 Flip the lever on the suction cup toward you.
- 2 Pull the tab on the suction cup toward you.

# Troubleshooting

## The suction cup will not stay on my windshield

- 1 Clean the suction cup and windshield with rubbing alcohol.
- 2 Dry with a clean, dry cloth.
- 3 Mount the suction cup ([Mounting and Powering the Device in Your Vehicle, page 3](#)).

## The mount does not hold my device in place while I drive

For the best results, you should keep the vehicle mount clean and position the device close to the suction cup. If the device shifts position while you are driving, you should complete these actions.

- Remove the powered mount from the suction cup arm, and wipe the ball and socket with a cloth. Dust and other debris may reduce the friction in the ball and socket joint and allow the joint to shift while you are driving.
- Rotate the hinged arm toward the suction cup as far as your windshield angle allows. Positioning the device closer to the windshield reduces the effect of jarring and vibration from the road.

## My device is not acquiring satellite signals

- Verify the location services feature is enabled ([Enabling or Disabling Location Services, page 49](#)).
- Take your device out of parking garages and away from tall buildings and trees.
- Remain stationary for several minutes.

## The device does not charge in my vehicle

- Verify the vehicle is turned on and is supplying power to the power outlet.
- Verify the interior temperature of the vehicle is within the charging temperature range indicated in the specifications.
- In the vehicle fuse box, verify the fuse for the vehicle power outlet is not broken.

## My battery does not stay charged for very long

- Decrease the screen brightness ([Display Settings, page 48](#)).
- Shorten the display timeout ([Display Settings, page 48](#)).
- Decrease the volume ([Adjusting Sound and Notification Volume, page 49](#)).
- Put the device in power saving mode when not in use ([Turning the Device On or Off, page 6](#)).
- Keep your device away from extreme temperatures.
- Do not leave your device in direct sunlight.

## My device does not connect to my phone

- Select **Settings > Wireless Networks > Bluetooth**.  
The Bluetooth option must be enabled.
- Enable Bluetooth wireless technology on your phone and bring your phone within 10 m (33 ft.) of the device.
- Verify your phone is compatible.  
Go to [www.garmin.com/bluetooth](http://www.garmin.com/bluetooth) for more information.
- Complete the pairing process again.  
To repeat the pairing process, you must unpair your phone and device (*Deleting a Paired Bluetooth Device*, page 33), and complete the pairing process.

## Appendix

### Garmin PowerSwitch

#### **WARNING**

Garmin strongly recommends having an experienced installer with the proper knowledge of electrical systems install the device. Incorrectly wiring the power cable can result in damage to the vehicle or the battery and can cause bodily injury.

You can use a connected Garmin PowerSwitch device to control lights, fans, and more from your RV / Camper device.

### Mounting Considerations

- The device must be mounted close to the battery and within the range of the supplied power cable.
- The mounting surface must be strong enough to support the weight of the device.
- The location must allow room for the routing and connection of all cables.

## Mounting the Device

Before you can mount the device, you must select a mounting location and purchase the appropriate hardware for your mounting surface.

### NOTICE

Avoid wires, gauges, air bags, air bag covers, HVAC, and other items when drilling pilot holes and attaching the mount to the vehicle. Garmin is not responsible for any damages or consequences arising from the installation.

- 1 Place the mount on the selected location.



- 2 Using the mount as a template, mark the two screw locations ①.
- 3 Drill pilot holes (optional).  
For some types of mounting material, drilling pilot holes is necessary. Do not drill through the mount.
- 4 Securely fasten the mount to the surface using the appropriate hardware for your mounting surface.

## Opening the Front Cover

You must open the front cover to make electrical connections.

- 1 Lift the front cover latch ① and rotate it counter-clockwise.



- 2 Pull the front cover off of the device.



## Connecting Accessories

### NOTICE

Do not use the device to control or power a winch. Failure to follow this notice could cause damage to your vehicle or your device.

Accessory requirements:

- Verify the amperage rating of each accessory before wiring it to the Garmin PowerSwitch device. The device supports accessories up to 30 A for each channel and a maximum of 100 A for the entire system.
- Use 10 AWG (6 mm<sup>2</sup>) wires for accessories that use 20 to 30 A.
- Use 12 AWG (4 mm<sup>2</sup>) wires for accessories that use 10 to 20 A.
- Use 14 AWG (2.5 mm<sup>2</sup>) wires for accessories that use less than 10 A.
- Use the appropriate size terminals for all accessory connections.
- Crimp all terminal connectors securely.

- 1 Connect the positive wire from the accessory ① to one of the accessory terminals ② on the Garmin PowerSwitch device.

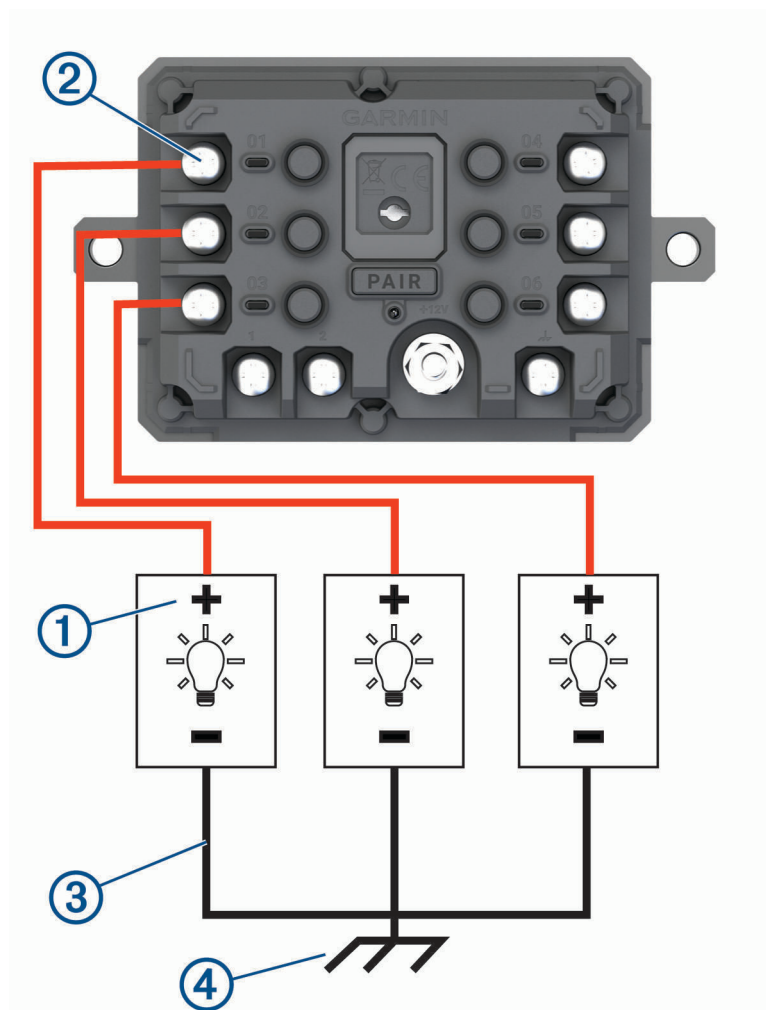

- 2 Connect the negative or ground wire ③ to an unpainted ground stud ④ on the vehicle frame, to a ground distribution block, or directly to the negative terminal on the battery.

### NOTICE

Do not connect the accessory ground wires to the ground terminal (GND) on the Garmin PowerSwitch device. Failure to heed this notice could result in personal or property damage, or negatively impact device functionality.

## Connecting a Control Input

You can connect to the control terminals to enable the Garmin PowerSwitch device to turn on customizable outputs. For example, you can connect your vehicle ignition switch to a control input terminal to turn on accessories automatically each time you start your vehicle. The control terminals detect a signal from 3.3 V to 18 V. You can configure output functions with the Garmin PowerSwitch app.

Connect the control wire from the control source in your vehicle to one of the two control terminals on the Garmin PowerSwitch device.

## Connecting the Device to Vehicle Power

Before you can connect the device to vehicle power, you must remove the warning tag from the +12V terminal on the device.

You should always confirm all electrical connections are secure and will not come loose while operating the device.

- 1 Connect the large ring end of the included ground wire ① to the negative terminal on the vehicle battery.

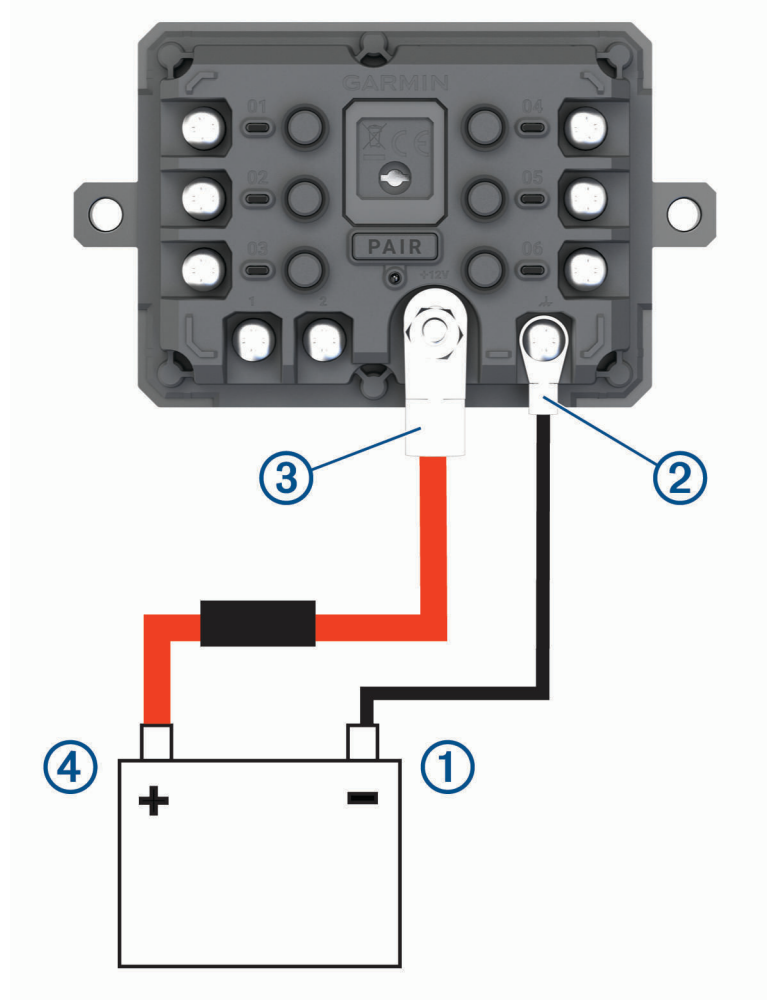

- 2 Connect the small ring end of the ground wire to the **GND** terminal ② on the device.
- 3 Connect the small ring end of the included 12V cable to the **+12V** terminal ③ on the device.
- 4 Tighten the  $\frac{3}{8}$  in. nut on the +12V terminal to a maximum torque specification of 4.52 N-m (40 lbf-in.). You should confirm the nut cannot be loosened by hand.

### NOTICE

Do not overtighten the +12V terminal to prevent damage to the terminal.

- 5 Connect the large ring end of the 12V cable ④ to the positive terminal on the vehicle battery.

## Pairing with a Garmin Navigation Device

You can pair your Garmin PowerSwitch device with a compatible Garmin navigation device.

- 1 Turn on power to your Garmin PowerSwitch device, and place your compatible Garmin navigation device within 1 m (3.3 ft.) of it.
- 2 On your compatible navigation device, open the Garmin PowerSwitch app.
- 3 Follow the on-screen instructions to complete the pairing and setup process.

The main app dashboard appears. After the devices are paired, they connect automatically when they are turned on and within range.

## Garmin PowerSwitch Specifications

Dimensions (D x W x H)	75 x 125 x 32 mm (2.95 x 4.92 x 1.26 in.)
Operating temperature range	From -25° to 85°C (from -13° to 185°F)
Wireless frequency	2.4 GHz @ 14 dBm
Power input	From 12 to 16 V using the included vehicle power cable.
Maximum accessory output	30 A
Maximum system output	100 A
Current draw with all outputs off	3 mA
Water rating	IEC 60529 IPX7 <sup>1</sup>

## Troubleshooting

### My Garmin PowerSwitch will not stay connected

- Verify the Garmin PowerSwitch device is receiving power.
- Verify that Bluetooth technology is enabled on your paired navigation device or smartphone.
- Move the navigation device or smartphone closer to your Garmin PowerSwitch device.
- Verify that your vehicle's battery is supplying at least 12 V of power.

The Garmin PowerSwitch device turns off all outputs automatically to preserve your vehicle's battery if it is receiving less than 11 V of power (*My accessories are not receiving power, page 60*).

### My accessories are not receiving power

- Verify the Garmin PowerSwitch device is receiving power from the vehicle battery.
- Verify that your vehicle's battery is supplying at least 12 V of power.

The Garmin PowerSwitch device turns off all outputs automatically to preserve your vehicle's battery if it is receiving less than 11 V of power. Outputs turn back on when the device detects more than 12 V of power.

- Verify that all electrical connections are secure and will not come loose while operating the vehicle.
- Verify that each connected accessory draws less than 30 A.

If an accessory draws more than 30 A, the device turns off that output automatically.

- Verify that the total system load is less than 100 A.

If the device detects a system load of more than 100 A, it turns off all outputs automatically.

- Inspect all electrical connections for an electrical short circuit.

## Backup Cameras

Your device can display the video feed from one or more connected backup cameras.

<sup>1</sup> The device withstands incidental exposure to water of up to 1 m for up to 30 min. For more information, go to [www.garmin.com/waterrating](http://www.garmin.com/waterrating).

## Pairing a BC™ 35 Backup Camera with a Garmin Navigation Device

You must enable the Wi-Fi setting on your Garmin navigation device before you can connect to a camera.

The BC 35 wireless backup camera is compatible with some Garmin navigation devices with Android. Go to [garmin.com/bc35](http://garmin.com/bc35) for more information about device compatibility.

You can pair up to four BC 35 wireless backup cameras with your compatible Garmin navigation device.

- 1 Update your navigation device to the latest software.

Your device may not support the BC 35 camera without the latest software. For more information about updating, see the owner's manual for your navigation device.

- 2 Turn on the Garmin navigation device, and bring it within 3 m (10 ft.) of the camera.

- 3 Select  > **Tools** > **Rear View** >  > **Garmin BC35**.

- 4 Select your BC 35 camera from the list of available cameras.

**NOTE:** The pairing code or password is located on the transmitter of the camera.

- 5 Select **Setup**, and position the guidance lines using the on-screen arrows.

If the camera or vehicle is not ideally positioned to complete the guidance line alignment, you can complete the alignment later.

- 6 Select **Save**.

After you complete the pairing process with a camera for the first time, it connects automatically to the Garmin navigation device.

## Connecting a Wired Backup Camera

To connect a wired backup camera, you must use an optional video mount accessory, which includes a 3.5 mm composite video input jack. Go to [garmin.com](http://garmin.com) to purchase an accessory mount. The video mount accessory is included with some device models.

You can connect a wired backup camera and view the output on the device screen.

- 1 Replace the original device mount with the video mount accessory.
- 2 Plug the camera video cable into the video input jack  on the mount.





## Viewing the Backup Camera

### WARNING

This device is intended to enhance the situational awareness when used properly. If used improperly, you could become distracted by the display, which could lead to an accident causing serious personal injury or death. Only access the information displayed on the device with a glance. Always maintain awareness of your surroundings and do not stare at the display or become distracted by the display. Focusing on the display could prevent you from avoiding obstacles or hazards.

Your device shows video from the connected backup camera in different ways, depending on how the camera is connected to power.

- 1 Select an option to show video:
  - If the camera is connected to a reverse lamp (recommended), place the vehicle into reverse. The device automatically shows video from the backup camera.
  - If the camera is connected to a steady power source, select  > **Tools** > **Rear View** to manually view the camera.
- 2 Select an option to resume normal device operation:
  - If the camera is connected to a reverse lamp (recommended), take the vehicle out of reverse. The device automatically resumes normal operation.
  - If the transmitter is connected to a steady power source, select  to manually hide the camera.



### Switching Cameras

When multiple backup cameras are transmitting to your device, you can switch between the views from the cameras.

- 1 Select  > **Tools** > **Rear View**.
- 2 Select a camera from the bottom of the screen. The video feed from the camera appears.

### Changing the Camera Orientation

Depending on where the camera is placed on your vehicle, the video on your device may appear upside down or mirrored by default. You can rotate the video horizontally or flip the video vertically to correct the video.

- 1 Select  > **Tools** > **Rear View** > .
- 2 Select an option:
  - Select **Mirror Video**.  
**NOTE:** This is useful for cameras placed on the front or rear of your vehicle.
  - Select **Flip Video**.  
**NOTE:** This is useful for cameras placed on either side of your vehicle.

## Connecting a Dash Camera to the Powered Mount

Before you connect a dash camera to the powered mount, you should mount the dash camera device to your windshield.

You can use the RV / Camper device mount to power a compatible Garmin dash camera. This can be useful if you need to connect the RV / Camper device and the dash camera to the same power source in your vehicle.

- 1 Mount the RV / Camper device in your vehicle, and connect it to power ([Mounting and Powering the Device in Your Vehicle](#), page 3).
- 2 If necessary, remove the RV / Camper device from the magnetic mount for a better view of the USB port.
- 3 Plug the dash camera's power cable into the USB port ① on the mount.



## Data Management

The device has a memory card slot for additional data storage.

**NOTE:** The device is compatible with Windows 7 and newer, and Mac OS 10.4 and newer. Mac computers may require additional third-party software to read and write files on Android devices.

### About Memory Cards

You can purchase memory cards from an electronics supplier, or purchase pre-loaded Garmin mapping software ([www.garmin.com](http://www.garmin.com)). Memory cards can be used to store files such as maps and custom POIs.

### Installing a Memory Card for Maps and Data

You can install a memory card to increase the storage space for maps and other data on your device. You can purchase memory cards from an electronics supplier, or go to [www.garmin.com/maps](http://www.garmin.com/maps) to purchase a memory card with pre-loaded Garmin mapping software. The device supports microSD memory cards from 4 to 256 GB. Memory cards must use the FAT32 file system format. Memory cards greater than 32 GB must be formatted using the device ([Formatting the Memory Card](#), page 64).

- 1 Locate the map and data memory card slot on your device ([Device Overview](#), page 2).
- 2 Insert a memory card into the slot.
- 3 Press it in until it clicks.

## Formatting the Memory Card

The device requires a memory card formatted using the FAT32 file system. You can use the device to format your card using this file system.

You must format a brand new memory card if it is not formatted using the FAT32 file system.

**NOTE:** Formatting the memory card deletes all data on the card.

- 1 Select **Settings > Device > Storage & USB**.
- 2 Select your memory card.
- 3 Select **⋮ > Settings > Format > ERASE & FORMAT**.
- 4 Select **Done**.

## Connecting the Device to Your Computer

You can connect the device to your computer using a USB cable.

- 1 Plug the small end of the USB cable into the port on the device.
- 2 Plug the larger end of the USB cable into a port on your computer.
- 3 When your RV / Camper device prompts you to enter file transfer mode, select **Yes**.

Depending on your computer operating system, the device appears as either a portable device, a removable drive, or a removable volume.

## Transferring Data From Your Computer

- 1 Connect the device to your computer ([Connecting the Device to Your Computer, page 64](#)).  
Depending on your computer operating system, the device appears as either a portable device, a removable drive, or a removable volume.
- 2 On your computer, open the file browser.
- 3 Select a file.
- 4 Select **Edit > Copy**.
- 5 Browse to a folder on the device.  
**NOTE:** For a removable drive or volume, you should not place files in the Garmin folder.
- 6 Select **Edit > Paste**.

## Transferring GPX Files From Your Computer



Apple computers may require additional third-party software, such as Android File Transfer, to read and write files on this device.

If you have already created routes that you want to use on your device, you can transfer GPX files directly from your computer.

- 1 Connect the device to your computer ([Connecting the Device to Your Computer, page 64](#)).  
The device appears as a portable device.
- 2 On your computer, open the file browser.
- 3 Select a GPX file.
- 4 Select **Edit > Copy**.
- 5 Browse to the GPX folder on the device.
- 6 Select **Edit > Paste**.

## Exporting GPX Files with the Garmin Drive App

You can share data, such as waypoints and routes, in GPX file format using the Garmin Drive app.

- 1 On your RV / Camper device, select an option:
  - To share waypoints, select **Where To? > Saved >  > Share > Garmin Drive.**
  - To share routes, select ** > Navigation > Trip Planner > Saved Trips >  > Share > Garmin Drive.**
- 2 Select one or more waypoints or routes.
- 3 Select **Done**.
- 4 On your phone, open the Garmin Drive app.
- 5 Follow the on-screen instructions to share the .gpx files.



## Importing GPX Files with the Garmin Drive App

You can import data, such as waypoints and routes, in GPX file format using the Garmin Drive app. For example, you can send waypoints or routes received in an email to your RV / Camper device.

- 1 On your smartphone, select a .gpx file and open it with the Garmin Drive app.
- 2 Follow the on-screen instructions in the Garmin Drive app.
- 3 On your RV / Camper device, select an option:
  - To view imported waypoints, select **Where To? > Saved.**
  - To view imported routes, select ** > Navigation > Trip Planner > Saved Trips.**

## Exporting GPX Files with a Memory Card

You can share data, such as waypoints and routes, in GPX file format to a compatible microSD card.

- 1 Insert a compatible microSD card into the memory card slot on your device (*Installing a Memory Card for Maps and Data, page 63*).
- 2 On your RV / Camper device, select an option:
  - To share waypoints, select **Where To? > Saved >  > Share > Memory Card.**
  - To share routes, select ** > Navigation > Trip Planner > Saved Trips >  > Share > Memory Card.**
- 3 Select one or more waypoints or routes.
- 4 Select **Done**.

## Importing GPX Files with a Memory Card

You can import data, such as waypoints and routes, in GPX file format from a compatible microSD card.

- 1 Insert a compatible microSD card containing one or more .gpx files into the memory card slot on your device (*Installing a Memory Card for Maps and Data, page 63*).  
The RV / Camper device automatically imports any .gpx files found on the microSD card.
- 2 Select an option:
  - To view imported waypoints, select **Where To? > Saved.**
  - To view imported routes, select ** > Navigation > Trip Planner > Saved Trips.**

## Purchasing Additional Maps

- 1 Go to your device product page at [garmin.com](http://garmin.com).
- 2 Click the **Maps** tab.
- 3 Follow the on-screen instructions.

## Purchasing Accessories

Go to [garmin.com/accessories](http://garmin.com/accessories).

# Index

## Symbols

2-D map view **30**  
3-D map view **30**

## A

accessories **55, 65**  
active lane guidance **14**  
addresses, finding **20, 31**  
alarm **49**  
alarm volume **49**  
alerts **11**  
    audio **48**  
    proximity points **48**  
AM **41**  
amplifier **42**  
answering calls **32**  
app overview **44**  
apps **8**  
audio, proximity points **48**  
auxiliary input **40**  
avoidances **17**  
    area **17, 18**  
    deleting **18**  
    disabling **18**  
    road **17**  
    road features **17**  
    tolls **17**

## B

backup camera **61, 62**. See cameras  
bass **39**  
battery  
    charging **3, 50, 54**  
    maximizing **54**  
    problems **54**  
Bluetooth devices **38**  
Bluetooth technology **30, 32, 55**  
    deleting a paired device **33**  
    disconnecting a device **33**  
    enabling **47**  
    pairing a phone **31**  
brightness **9**

## C

calls **32**  
    answering **32**  
    placing **35**  
camera  
    dash cam **63**  
    pairing **61**  
cameras **62**  
    backup **62**  
    red light **11**  
    speed **11**  
    switching **62**  
camper, profiles **9, 10**  
changing the search area **21**  
charging the device **3, 50, 54**  
cleaning the device **53**  
cleaning the touchscreen **53**  
computer, connecting **63, 64**  
control input **45**  
coordinates **23**  
current location **24**  
custom POIs **22**

## D

dash cam **63**  
deleting  
    paired Bluetooth device **33**  
    service categories **42**  
    service records **43**  
    trips **36**

destinations **43**. See locations  
    arriving **14, 15**  
detours **16**  
device care **53**  
directions **14**  
disconnecting, Bluetooth device **33**  
display settings **48**  
driver alerts **11**  
driving directions **14**  
DSP **40, 41**

## E

editing, saved trips **37**  
emergency services **24**  
EULAs **49**  
exit services **27**  
extras, custom points of interest **22**

## F

files **65**  
    transferring **64, 65**  
finding locations. **18, 19, 21, 23** See also  
    locations  
        addresses **20**  
        categories **20**  
        cities **27**  
        coordinates **23**  
        intersections **22**  
finding services **19**  
FM **41**  
Foursquare **23**  
fuel, stations **24**

## G

gain **40**  
Garmin Connect **30**  
Garmin Express **53**  
    updating software **52**  
going home **12**  
GPS **7**  
    simulator **49**

## H

hands-free phone calls **33**  
headset, pairing **31**  
home  
    editing location **12**  
    going **12**  
home screen **7**  
home customization **8**

## I

icons, status bar **8**  
ID number **49**  
intersections, finding **22**

## L

language **49**  
latitude and longitude **23**  
location services **49**  
locations **20, 43**  
    current **24, 25**  
    recently found **23**  
    saving **24**  
    searching for **18, 22**  
    simulated **49**

## M

map layers, customizing **30**  
map perspective **30**  
map view  
    2-D **30**  
    3-D **30**  
maps **12, 26, 29, 47**  
    data field **13, 29, 30**  
    detail level **47**  
    layers **30**  
    purchasing **65**

    symbols **13**  
    theme **47**  
    tools **26**  
    updating **51, 52**  
    viewing routes **13, 14**  
media player **39**  
    source **38**  
media volume **49**  
memory card **2, 63**  
    formatting **64**  
    installing **63**  
microSD card **2, 63**  
mount, removing **53**  
mounting the device **6, 54, 56–59**  
    automobile **3**  
    suction cup **3, 54**  
music player **39**  
mute **39**  
myTrends, routes **16**

## N

national parks **19**  
navigation **13, 14, 35**  
    settings **47**  
next turn **13**  
notification volume **49**  
notifications **8, 31–33**

## O

owner's manual **35**

## P

pairing **31, 60**  
    deleting a paired device **33**  
    disconnecting **33**  
    headset **31**  
    phone **31, 55**  
parking **15, 21, 22**  
phone, pairing **31, 55**  
phone calls **32, 33**  
    answering **32**  
    dialing **32**  
    muting **32**  
POI Loader **22**  
points of interest (POI) **19, 23**  
    custom **22**  
    extras **22**  
    HISTORY **19**  
    POI Loader **22**  
power cables **50**  
    vehicle **3, 58, 59**  
power key **2, 6**  
power switch **44**  
    customizing **45, 46**  
presets **41**  
product support **35**  
profiles, camper **9, 10**

## Q

Quick Search **20**

## R

recently found locations **23**  
red light cameras **11**  
removing mount **53**  
resetting **41**  
    device **53**  
    trip data **29**  
restoring settings **49**  
restrictions, vehicle **9**  
routes **12**  
    adding a point **15, 37**  
    calculating **16**  
    calculation mode **37**  
    myTrends **16**  
    shaping **15**  
    starting **12, 21**

- stopping **16**
- suggested **16**
- viewing on the map **13, 14**

## S

- satellite signals, acquiring **7, 49**
- saved locations **37**
  - categories **25**
  - deleting **25**
  - editing **25**
- saving, current location **25**
- screen, brightness **9**
- search bar **20**
- service history
  - categories **42**
  - deleting **42, 43**
  - editing **43**
  - records **42, 43**
- settings **41, 47–49**
- shaping a route **15**
- shortcuts
  - adding **8, 24**
  - deleting **24**
- simulated locations **49**
- sleep mode **6**
- smartphone features **33**
  - connecting **31**
- software
  - updating **51, 52**
  - version **49**
- sound **49**
- source **38**
- speaker zones **39–42**
- speaking commands **35**
- specifications **50, 60**
- speech recognition **35**
- speed cameras **11**
- subwoofer **40**
- suction cup **54**

## T

- theft, avoiding **53**
- time settings **49**
- tolls, avoiding **17**
- tone **39**
- tools, maps **26**
- touchscreen **8**
- TracBack **37**
- traffic **29, 34, 48**
  - alternate route **16**
  - incidents **30, 34**
  - map **29, 34**
  - receiver **34**
  - searching for delays **30, 34**
- travel history **49**
- treble **39**
- trip information **29**
  - resetting **29**
- trip log, viewing **29**
- trip planner **36, 37**
  - editing a trip **36**
  - shaping points **37**
- TripAdvisor **23**
- troubleshooting **54, 55, 60**
- turn list **14**

## U

- unit ID **49**
- up ahead **26, 27**
  - customizing **27**
- updating
  - maps **51, 52**
  - software **51, 52**

## V

- vehicle power cable **3, 59**

- vehicle profile
  - camper **9, 10**
  - car **9**
- voice command **35**
  - activating **35**
  - tips **35**
- voice prompt **33**
- volume **42, 49**
  - adjusting **35, 39**

## W

- warning icons **27–29**
- weather **43**
- Where Am I? **24, 25**
- Wi-Fi, connecting **38, 47**
- Wi-Fi **51**
- wireless camera. See cameras
- wireless headset **33**



