

VICTORY[®]

INSTALLATION AND OPERATING INSTRUCTIONS for all HS, and HIS Warming Cabinets



809-195A Rev D. 02/05/2026

3779 CHAMPION BLVD, WINSTON-SALEM, NC 27105

Phone: (888) 845-9800 | Fax: (800) 253-5168 | Web: victoryrefrigeration.com

**SEE BACK COVER FOR
WARRANTY REGISTRATION**



WELCOME

Congratulations on your purchase of Victory food service equipment. Every employee welcomes you to the family of satisfied Victory customers.

From the earliest stages of production design, to focused steps in fabrication and assembly, rigid standards of quality are maintained by our staff of skilled employees. Victory strives to supply superior products through strict quality control guidelines exceeding industry standards, this means that each unit, given the proper maintenance will provide years of trouble free experience to its owner.

Additionally, Victory food service equipment has one of the best warranties in the food service industry, and backed by a professional staff of service technicians across the country.

We thank you for your choice and confidence in Victory Equipment.

Important Information

- PLEASE READ THESE INSTRUCTIONS CAREFULLY BEFORE INSTALLING OR USING, IF RECOMMENDED PROCEDURES ARE NOT FOLLOWED, WARRANTY CLAIMS MAY BE DENIED.
Your warranty registration information is located with this manual. Please complete the card and submit it to Victory within TEN days of installation. Failure to properly register equipment may limit or void the warranty.
Victory reserves the right to change specifications and product design without notice. Such revisions do not entitle the buyer to corresponding changes, improvements, additions, or replacements for previously purchased equipment.

Contents

Table listing page numbers for sections: Safety (3), Important Information (5), Product Information (6), Clearance and Placement (7), Unpacking and Set Up (8), Set Up for Units Without Legs/Casters (9), Shelf Installation (10), Electrical (11), Preheating & Food Storage (12), Recommended Food Storage Periods (13), Using the Unit (14), Carel Applica App (15), Sequence of Operations (17), Electronic Controller Display (18), Changing the Operating Set Point (21), Alarm Codes (23), Cleaning and Maintenance (27), Methods For Cleaning Stainless Steel (28), Help (29), Help Continued (30), For The Service Tech - Wiring Diagram (31), Limited Warranty (32), Limited Warranty (continued) (33)



SAFETY

This appliance has been designed with your safety in mind. It has many features to keep you from being harmed. However, safe operation and maintenance are your responsibilities. This appliance is not intended for use by persons (including children) with reduced physical, sensory or mental capabilities, or lack of experience and knowledge, unless they have been given supervision or instruction concerning use of the appliance by a person responsible for their safety.

Children should be supervised to ensure that they do not play with the appliance.



Use: When using this unit, please:

- **Move it carefully.** If on casters be sure the casters do NOT run over the power cord.
- **Lock** the casters when in use.
- **Seek help.** This machine is heavy! Be sure to move with enough help to avoid tipping or dropping the cabinet.



- **Prevent children from playing in or on the cabinet.** Persons unable to use this product must be prevented access.
- **Follow all instructions.** There are many safety labels and directions on the unit. Heed them.
- **Watch your fingers.** There may be pinch points near the door hinges.

Important Information to Add

Record the model number, serial number and the date of installation here for future reference. The model and serial numbers are on the unit's serial number dataplate, which is located on the left inside wall.

Model Number	
Serial Number	
Date of Installation	
Purchased From	



Observe the **Caution** and **Warning** notices. They are indicators of important safety information. Keep this manual for future reference.

SAFETY



CAUTION

CAUTION: If it is necessary to move the Cabinet after removal from the skid, remove all doors and carefully push the unit at a point of no more than 36" from the bottom to avoid damage.



Do NOT push in this area.

Height will vary by model

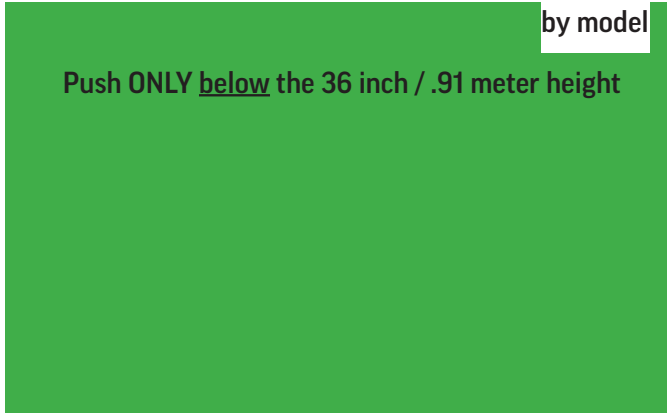

Push ONLY below the 36 inch / .91 meter height



IMPORTANT INFORMATION

This unit is intended to be used in a commercial application. That includes bars and restaurants.

If installed in a residence some commercial service companies may not be able to service it on site.

Limitations

The machine is designed for use indoors in a controlled environment. It must be kept dry, not overheated or subjected to excessive cold. May only be connected to a dedicated electrical circuit. Extension cords are not permitted.

The manufacturer has designed and produced this machine with the finest in materials. The manufacturer assumes no liability for units that have been altered in any way. Alterations or part substitutions will void the warranty.

	Minimum	Maximum
Voltage	208	240
Room Air Temp	60° F	100° F

Agency Approvals

These marks appear on the dataplate or serial tag, located in the inside of the left wall. The dataplate also contains the model and serial numbers as well as electrical requirements.



PRODUCT INFORMATION

Model	Cabinet Dimensions w x d x h (Inches)	Doors	Glass or Solid Door	Full Load Amps	Heater Watts	Power Cord Plug (NEMA)
STANDARD UNITS						
HS(A)-1D-1	26-1/2 X 34-7/8 X 84-1/8	1	SOLID	6.8	1500	6-20P
HS(A)-1D-1-HD	26-1/2 X 34-7/8 X 84-1/8	2	SOLID			
HS(A)-1D-1-G	26-1/2 X 33-5/8 X 84-1/8	1	GLASS			
HS(A)-1D-1-HG	26-1/2 X 33-5/8 X 84-1/8	2	GLASS			
PASS THRU UNITS						
HS(A)-1D-1-PT	26-1/2 X 38-3/4 X 84-1/4	2	SOLID	6.8	1500	6-20P
HS(A)-1D-1-PT-HD	26-1/2 X 38-3/4 X 84-1/4	4	SOLID			
HS(A)-1D-1-PT-G	26-1/2 X 36 X 84-1/4	2	GLASS			
HS(A)-1D-1-PT-HG	26-1/2 X 36-1/4 X 84-1/4	4	GLASS			
HS-2D-1-PT-GD	52 1/8 X 35 3/4 X 84 1/8	4	GLASS	13.0	3000	
EXTRA WIDE UNITS						
HS(A)-1D-1-EW	31-1/4 X 34-7/8 X 84-1/8	1	SOLID	6.8	1500	6-20P
HS(A)-1D-1-EW-HD	31-1/4 X 34-7/8 X 84-1/8	2	SOLID			
HS(A)-1D-1-EW-G	31-1/4 X 33-1/2 X 84-1/8	1	GLASS			
HS(A)-1D-1-EW-HG	31-1/4 X 33-5/8 X 84-1/8	2	GLASS			
EXTRA WIDE PASS THRU UNITS						
HS(A)-1D-1-EW-PT	31-1/4 X 38-3/4 X 84-1/8	2	SOLID	6.8	1500	6-20P
HS(A)-1D-1-EW-PT-HD	31-1/4 X 38-3/4 X 84-1/8	4	SOLID			
HS(A)-1D-1-EW-PT-G	31-1/4 X 35-7/8 X 84-1/8	2	GLASS			
HS(A)-1D-1-EW-PT-HG	31-1/4 X 36-1/8 X 84-1/8	4	GLASS			
STANDARD ROLL-IN UNITS						
HIS(A)-1D-1	36 1/2 X 36 1/4 X 84 3/8	1	SOLID	6.8	1500	6-20P
HIS(A)-2D-1	68 7/8 X 36 1/4 X 84 3/8	2	SOLID	13.0	3000	
STANDARD ROLL-THRU UNITS						
HIS(A)-1D-1-PT	36 1/2 X 40 1/8 X 84 3/8	2	SOLID	6.8	1500	6-20P
HIS(A)-2D-1-PT	68 7/8 X 40 1/8 X 84 3/8	4	SOLID	13.0	3000	
EXTRA HIGH ROLL-IN UNITS						
HIS(A)-1D-1-XH	36 1/2 X 36 1/4 X 89 7/8	1	SOLID	6.8	1500	6-20P
HIS(A)-2D-1-XH	68 7/8 X 36 1/4 X 89 7/8	2	SOLID	13.0	3000	
EXTRA HIGH ROLL-THRU UNITS						
HIS(A)-1D-1-PT-XH	36 1/2 X 40 1/8 X 89 7/8	2	SOLID	6.8	1500	6-20P
HIS(A)-2D-1-PT-XH	68 7/8 X 40 1/8 X 89 7/8	4	SOLID	13.0	3000	

Height includes casters

- All models are 208-240 volts, 60 Hz AC.
- ALWAYS REFERENCE YOUR EQUIPMENT DATA PLATE AMPS, FOR THE MOST UP TO DATE AND ACCURATE VALUES.
- HS models have stainless steel interiors, HSA models have aluminum interiors



CLEARANCE AND PLACEMENT

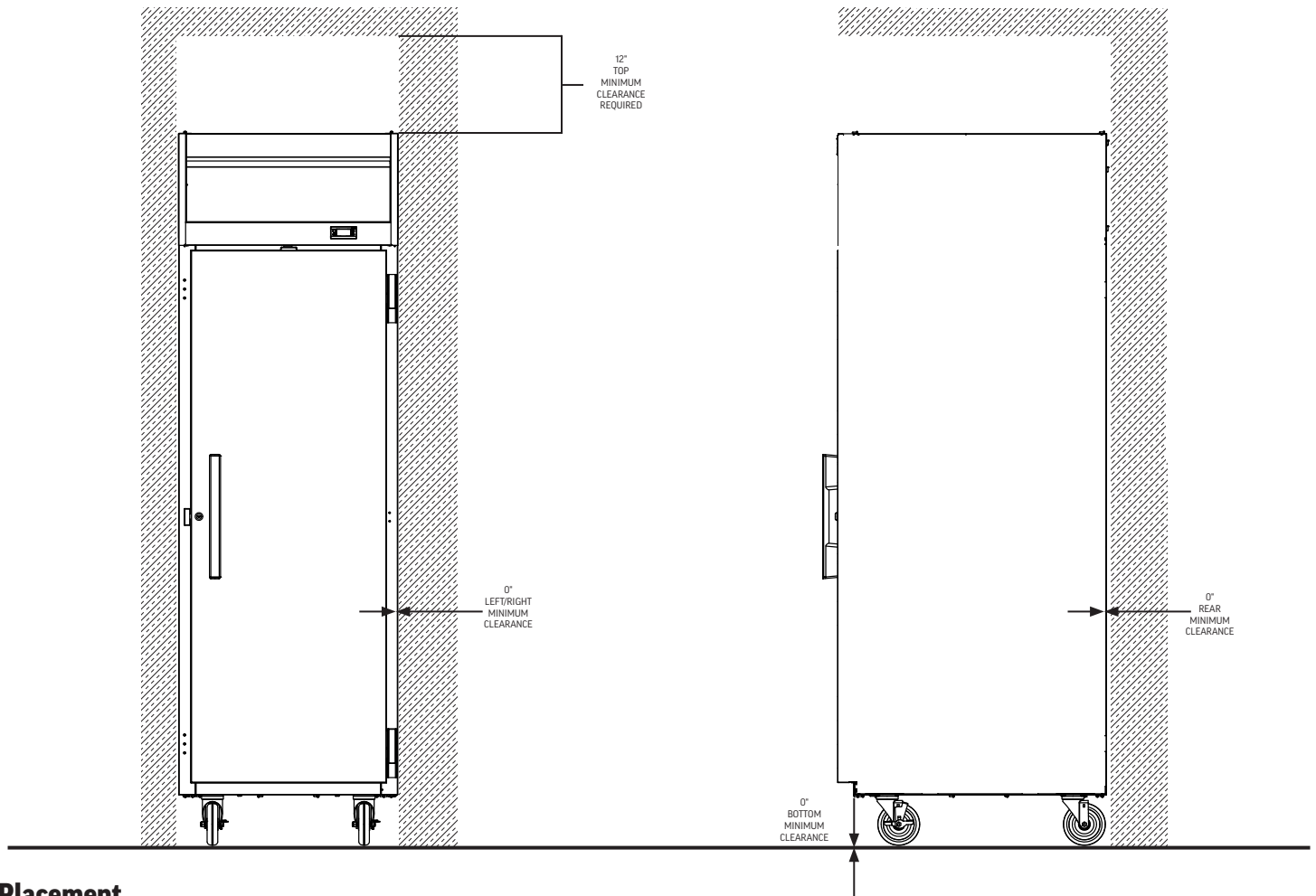

Placement

Consider the following when selecting a location for your Cabinet:

Clearance:

- 12 in. at the top
- 0.0 in. at the rear
- 0.0 in. at the left side
- 0.0 in. at the right side
- 0.0 in at the bottom

Floor Load: the floor on which the Cabinet is located must be even and level, free from vibrations, and strong enough to support the combined weights of the unit and maximum product load.

Ventilation: Grille area at front must be free and clear of any object or wall.

Power Outlet: The installation of this appliance requires a dedicated power outlet located within the length of the unit's power cord and be accessible for the purpose to disconnect power.

UNPACKING AND SET UP

Carefully inspect the shipping carton for damage. This is the only time that shipping damage may be claimed. If damage is suspected, open the carton immediately and, if there is damage, retain the carton and contact the shipper to make a claim. Do NOT contact the manufacturer.

Uncrating

Tools Needed: $\frac{3}{4}$ " box wrench, adjustable wrench, level, flat head screw driver, and box cutter.

1. Remove the cardboard top capping, all clear tape, and all staples including those at the bottom of the cardboard carton and skid.
2. Start from the top of the carton. Using the box cutter, carefully make one continuous cut to the bottom of the skid. Remove cardboard carton and discard.

Skid Removal and Caster Attachment

Tip the unit forward and remove the skid.



1. Remove the shipping bolts using the $\frac{3}{4}$ " box wrench while cabinet is held in one direction. Repeat the process while the cabinet is held in the opposite direction.
2. None of the threads on the leg or caster stem should be visible once screwed in.
3. Tilt the cabinet in one direction approximately 8" and block it securely with pieces of 2x4 lumber or other suitable material.
4. Thread the stem casters or legs into the $\frac{1}{2}$ "-13 holes in

Leveling:

Cabinets must be leveled when installed. Level should be measured on the headrail.

Failure to level your cabinet may result in door not sealing, closing correctly, voiding the warranty.

For cabinets with legs, rotate the foot of the leg with an adjustable wrench to achieve desired height for leveling.

For cabinets with casters, leveling can be achieved by placing large washers in between the $\frac{1}{2}$ " stud and the holes located on the bottom of the case.

Note: additional clear plastic protective wrap is applied directly to any product with a glass door.

3. Move unit as close to final position as possible before removing the skid.

Note: The skid must be removed before the casters or legs can be attached.

the bottom of the cabinet. Tighten by hand as much as possible. Some models may already have levelers installed. If so, then the levelers will need to first be removed and discarded.

5. Once the caster or leg cannot be turned any further, use a $\frac{3}{4}$ inch wrench to tighten the nut in between the mounting plate and the wheel of the caster until snug.
6. Repeat this procedure with unit secured in the opposite direction so as to access the remaining legs/casters/levelers
7. If plate casters or legs are installed instead of stem casters or legs, then repeat step 3 above and secure the plate with either #14 AB screws, or $\frac{1}{4}$ -20 screws, depending upon which are required.
8. If levelers are employed, then repeat step 3 above and thread the leveler in place. Then repeat step 6.
9. If legs/casters will not be installed, please see page 9.



Do NOT loosen casters to level the cabinet. Casters MUST be tightly secured to cabinet for full strength.

Install or attach any accessories that will be used

Remove any plastic covering the stainless steel.

SET UP FOR UNITS WITHOUT LEGS/CASTERS

Important: The floor where the cabinet is to be permanently located must be a level, flat surface prior to installation. Failure to properly level your equipment can void equipment warranty.

- If legs or casters are not installed, this equipment is required to be sealed to the floor to establish proper sanitary operation. This is a requirement called out in the NSF-4 standard and will be enforced by local health inspectors.
- For warming cabinets mounted directly onto the floor, the floor must be cleaned and dried in advance of the application of sealant.
- Once the warming cabinet is installed onto a clean, dry and level floor, the installation is to be completed by the application of silicone.

The application of the silicone is to be done in a manner to prevent spillage on adjacent surfaces of the floor from passing under the inaccessible portions of the warming cabinet.

INSTRUCTIONS:

1. Place the cabinet in the exact position in which it is to be set permanently.
2. Level the unit, inserting metal shims under unit where required. It is important that an accurate carpenter's level be used when leveling cabinet
3. Construct a wood form to act as a retainer for the grouting compound around the entire base of the cabinet. Pour the grout mixture at various intervals around the form to assure complete fill under the cabinet
4. Using a wide blade putty knife, taper the grout to a feather edge.
5. A tube of NSF approved silicone sealer, having an applicator type nozzle, is highly suited for sealing units to the floor. Apply a small uniform bead completely around the base of the cabinet.

If necessary to move the unit after removing it from the skid, remove all doors and carefully push the cabinet at a point no more than 36" (inches) from the bottom to avoid damage.

SHELF INSTALLATION

1. Determine the proper location for the shelf clips. The reference numbers on the pilaster can serve as a guide to ensure all clips are properly located.
2. Insert the top tab of the shelf clip into the desired hole of the pilaster. The retaining tab **MUST** be facing up as shown.
3. Rotate the clip downwards and insert the bottom tab into the matching hole in the pilaster. The clip may need to be squeezed slightly during installation.
4. Install all remaining clips.
5. Install shelves onto clips with the product retention bar facing up. Be careful not to dislodge clips during installation.
6. Place shelves so that the retaining tab on the clip captures the shelf as shown.
7. Confirm that the shelf is resting on **ALL 4** clips and that the clips are securely attached to the pilasters.
8. Improper shelf clip installation could cause the shelf and / or the product on it to fall, resulting in damage to the unit and possible bodily injury.
9. Do **NOT** overload the shelves. The unit is designed to use all shelves that are supplied in an equally spaced manner. Contact Victory customer service if fewer shelves or a different configuration to ensure shelf overloading will not occur.

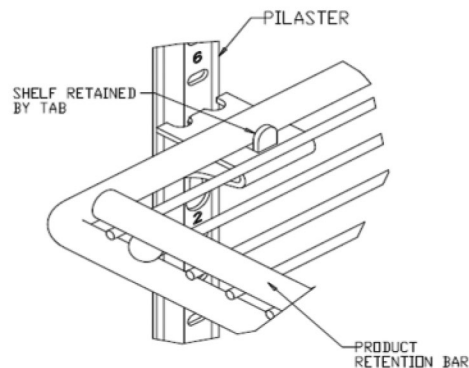
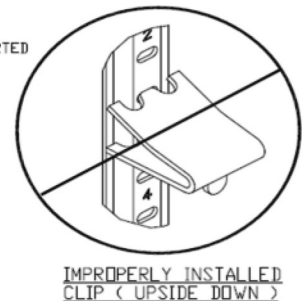
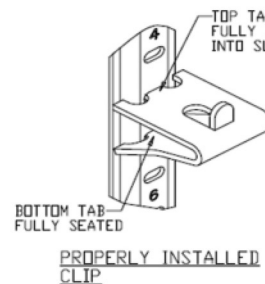
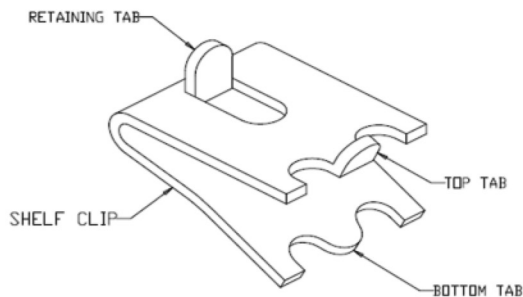

ELECTRICAL

This is a cord-connected unit, and must be connected to its own **dedicated** power supply. Check the dataplate on

the machine to confirm the voltage and per the dataplate use the correct fuses or circuit breakers.

Note: Do not connect to GFI / GFCI outlets. Connection to that type of outlet can result in product loss due to unsafe cabinet temperature when GFI device trips from moisture.

Power Cords

This 220 volt model is equipped with a power cord and type 6-20P plug.

If a power cord becomes damaged, it must be replaced with the identical cord.

Follow All National and Local Codes

This Unit Must Be Grounded. Do not use extension cords and do not disable or by-pass ground prong on electrical plug.

Prior to use, the interior and exterior surfaces of the cabinet should be cleaned thoroughly with warm water, mild detergent, and a soft cloth. Apply with a dampened cloth and wipe in the direction of the metal grain. Then allow to air dry with the doors open. Only use a clean soft cloth. See detailed cleaning instructions in the cleaning and maintenance section

Initial Start Up

After the cabinet has been installed, leveled, and cleaned as described above, refer to the following check list:

- Check for proper electrical hook-up.
- Check that all clearances are in line with the aforementioned guidelines.
- Check that cabinet is level.

NOTE: Once the unit has been started and reaches proper storage temperatures, it may be loaded with product.



PREHEATING & FOOD STORAGE

Food should not be placed in a cold warming cabinet. To preheat the warming cabinet, turn it on one (1) hour before it will be needed. See page 14 on how to use the control display panel to assist in preheating and operation.

If the food has been cooked in the same pan in which it will be served, it should be left in the same pan when being placed in the warming cabinet. However, if food is cooked and served in different pans, the food should be panned as soon as the cooking is completed and placed in the warmer. Although the two methods mentioned may not necessarily pertain to the requirements of daily foodservice activity, another approach for good food quality is to place the food directly to a serving counter after cooking. The warmer keeps the food in good condition during the interval between cooking and serving. It is recommended that food should be stored within the cabinet and in its original pan in which it will be served.

The food should be placed in the cabinet while hot, but not until it stops giving off steam

Note: if steam is excessive, use a lid on pots or pans.

 CAUTION	Risk of personal injury from hot pans or racks.
	User proper hot container handling materials.

It is possible to reheat some food without further deterioration if sufficient time is allowed for the heat to slowly penetrate the entire mass.

Most food can be kept in best condition at a temperature of approximately 160°F, but the exact temperature varies depending upon the kind of food and method of its preparation; therefore, it is impossible to give any exact instructions which will fit all conditions. It is necessary to experiment by increasing or decreasing the temperature of the unit until you find the temperature at which the majority of the food kept in the unit will keep in the best condition. Once this setting is determined, the controller should always be kept at this setting.

Some food, such as breaded meats, fish, etc., when kept at proper temperature, requires less degree of moisture in the cabinet to prevent sogginess. For this reason, all cabinets are equipped with vents or dampers. The damper should be opened for such food by turning the knob in the desired direction for opening and closing. This knob opens or closes the vent in the top of the cabinet. By looking into the cabinet when operating the knob, you can fully understand its function and adjustment.

Some foods can be kept in good condition much longer than others, and certain foods cannot be satisfactorily kept at all in any manner. French fried potatoes, roasts, waffles and similar foods, where the outside must be crisp and centers steaming hot must be prepared immediately before serving. Do not expect the impossible from the warming cabinet, but if used intelligently it will keep food over a longer period of time and with less deterioration than is possible with any other equipment. By reducing the deterioration between the time the food is cooked and the time it is served, the warming cabinet will assure serving the food to the customer in proper condition. See the recommended food storage periods table as a reference guide.



RECOMMENDED FOOD STORAGE PERIODS

Product	Longest Time Kept	Average Time Kept	Approximate Temp. °F
*Crispy or Dry Foods			
Baked Potatoes	2 hours	30 minutes	170 -180
Corn Stick	2 hours	1 hour	140 - 150
Crackers	8 hours	5 hours	140 - 150
Chicken Pies	6 hours	3 hours	170 - 180
Club Sandwiches (wrapped)	1 hour	30 minutes	160
Fried Chicken	6 hours	3 hours	170 -180
Fried Seafood	6 hours	2 hours	170 -180
Hard Rolls	8 hours	4 hours	140 - 150
Hot Mince or Apple Pie	6 hours	4 hours	160
Meat Pies	6 hours	3 hours	170-180
Popcorn & Potato Chips	10 hours	5 hours	150
*Moist Foods			
Baked Beans	8 hours	4 hours	170 -180
Baked Stuff Lobster	3 hours	2 hours	170 -180
Biscuits	1 hour	30 minutes	150 - 175
Casserole (without top crust)	8 hours	4 hours	170 - 180
Chop Suey	6 hours	4 hours	180
Deviled Crabs	5 hours	3 hours	170 -180
Frankfurter	6 hours	3 hours	160 - 175
Hash	4 hours	2 hours	170 -180
Mashed Potatoes	3 hours	2 hours	160 - 180
Vegetables (ready for serving)	6 hours	2 hours	170 -180
Sweet Rolls	4 hours	2 hours	140 - 150



USING THE UNIT

Operation is simple, just keep it connected to the correct power supply and the cabinet will maintain the internal temperature it has been set to. Keep the doors closed as much as possible to avoid unnecessary run time.

The controller displays the current internal temperature.

Adjusting the set temperature will NOT cause the system to reach the temperature faster. When on, the system is always operating at maximum.

The temperature was set at the factory at 160°F, but you can adjust it to your own selected temperature. But you can adjust them to your own selected temperature. See pages 21 & 22.

The internal fan will be on when the compressor is on and when the doors are closed.

The compressor and condenser fan motor will only be on when the controller senses an increase in internal cabinet temperature passed the set point.

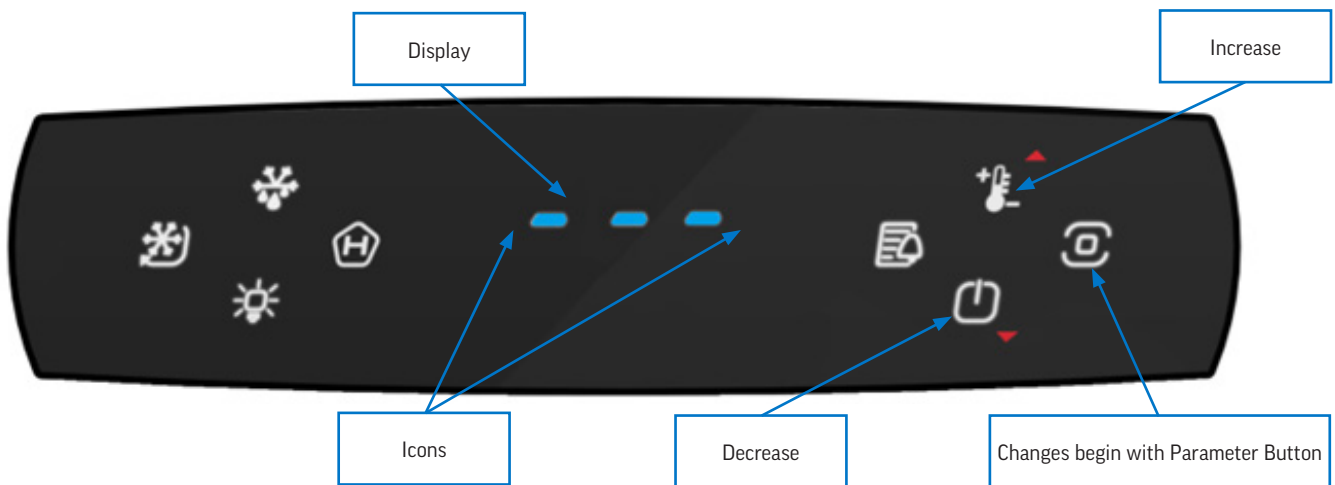

CAREL APPLICA APP

ACCESSING THE CONTROL VIA SMARTPHONE OR TABLET

Download the Carel **APPLICA** app through the App Store or Google Play Store to access the control via Bluetooth.

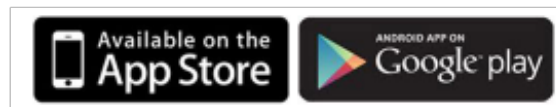

Open the app and select "Bluetooth" to search for your device. Select the Carel device that appears on the screen and wait for the control to connect.

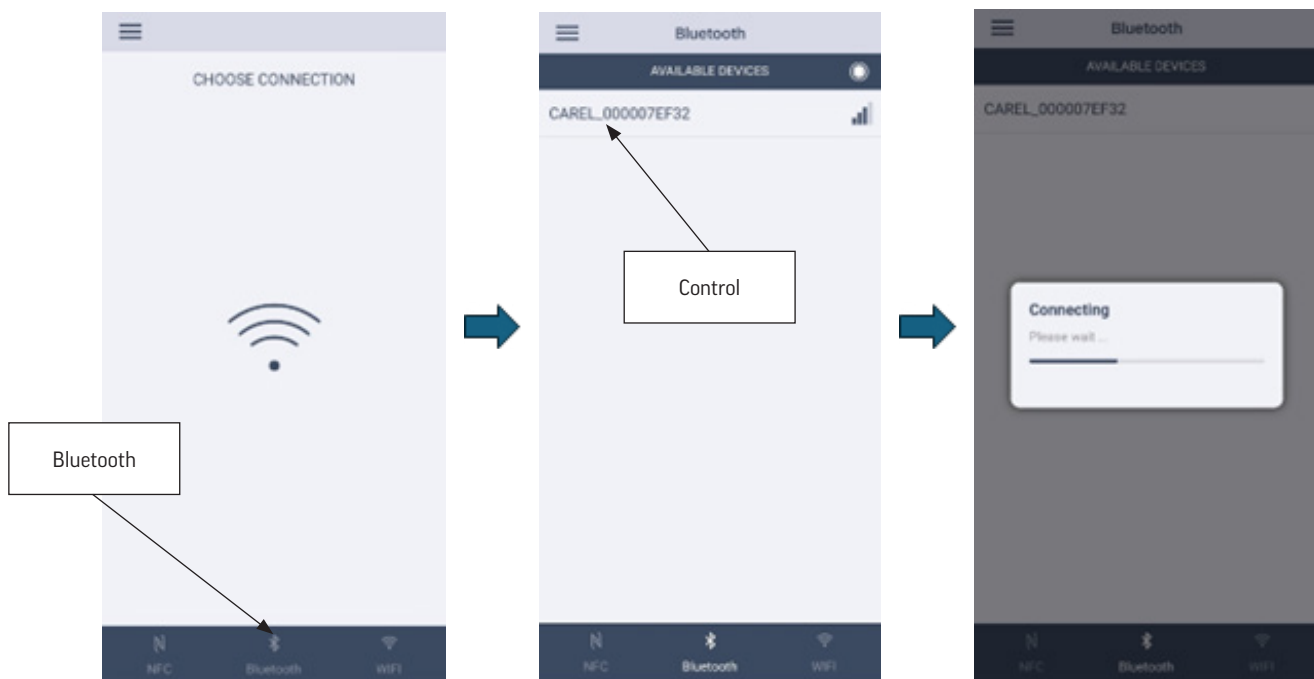

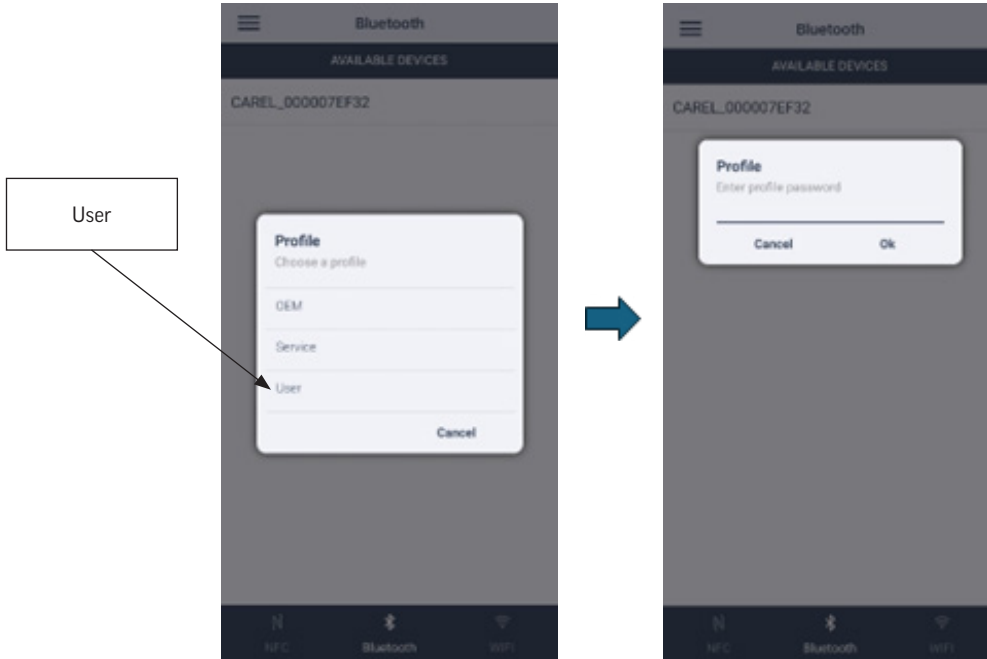

Select the "User" profile and type in the password: 0 and press "Ok".

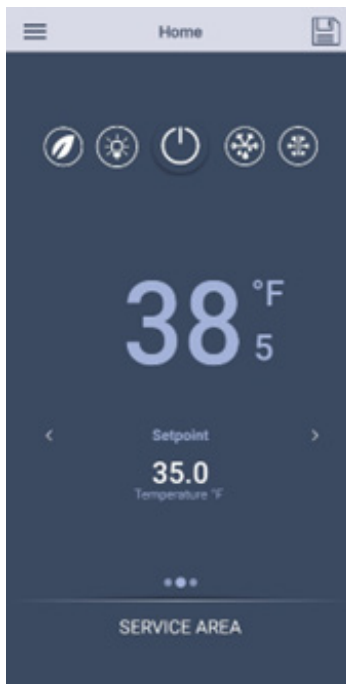

Arrive at the home page for the Applica App.



SEQUENCE OF OPERATIONS

COMPONENT	ON		OFF	
	OPERATION	CONTROLLER ACTION	OPERATION	CONTROLLER ACTION
COMPRESSOR	Compressor turns on when the cabinet temperature is above the sum of the set point and the dead band	The Compressor Contact is energized	Compressor turns off when the cabinet temperature is equal to or less than the set point	The Compressor Contact is de-energized
		IJF terminals N05, C5		IJF terminals N05, C5
CONDENSER FAN	The Condenser Fan turns on when the Compressor is running	The Condenser Fan is wired to the Compressor Relay on control	The Condenser Fan turns off when the Compressor is not running	The Condenser Fan is wired directly to the Compressor Control Relay
		IJF terminals N05, C5		IJF terminals N05, C5
EVAPORATOR FAN	The Evaporator Fan runs continuously except on door opening.	The Evaporator Fan Control contact is energized.	The Evaporator Fan turns off for 1 minute when the door is opened	The Evaporator Fan Control contact is de-energized
		IJF terminals N04, C3		IJF terminals N04, C3
LIGHT	The light will turn on when the door is open, or the light button is pressed 	The Light Control Contact is energized	The light will turn off when the door is closed, or the light button is pressed 	The Light Control Contact is de-energized
		IJF terminals N03, C3		IJF terminals N03, C3
FACE HEATER	Face Heater is on when condensing unit is on	Heater is wired with the compressor relay	The Face Heater is off when condensing unit is off	Heater is wired with the compressor relay







CONDITION	COMPRESSOR	CONDENSER FAN	EVAPORATOR FAN	LIGHTS
CABINET TEMP > SET POINT + DEAD BAND	ON	ON	ON	ON or OFF
CABINET TEMPERATURE <= SET POINT	OFF	OFF	ON	ON or OFF
DEFROST	OFF	OFF	ON	ON or OFF



ELECTRONIC CONTROLLER DISPLAY



CONTROL PANEL INDICATORS

	Auxiliary Output	Active
	Heater	Active
	Fans	Active
	°C	Unit of Measure °C
	°F	Unit of Measure °F
	Service Maintenance	Active Alarms

CONTROL PANEL CONNECTIONS

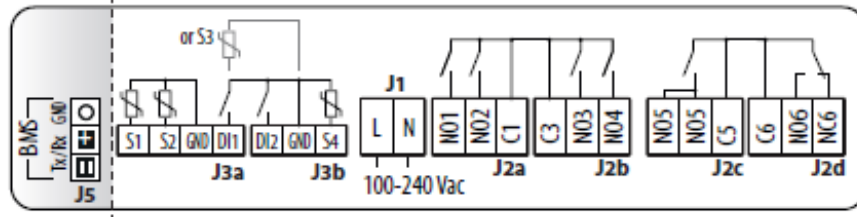



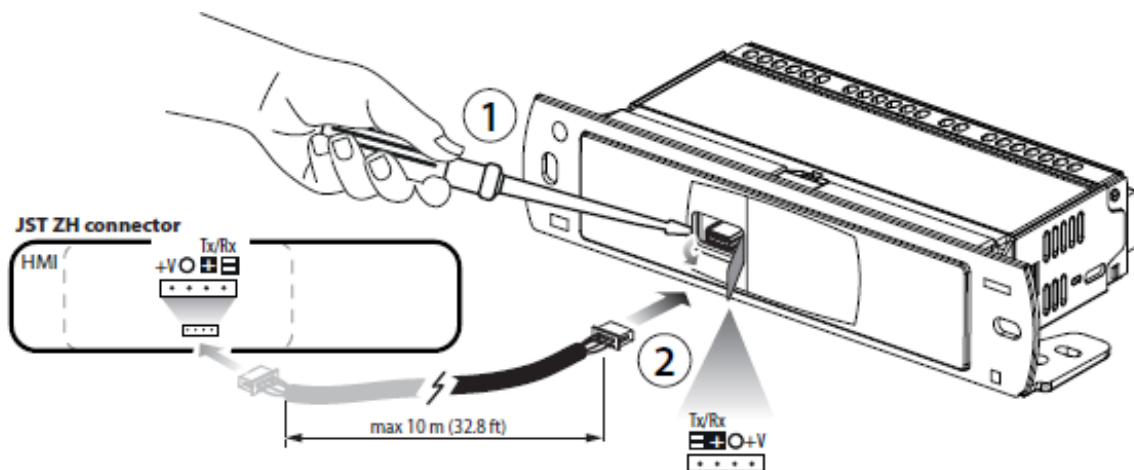

Relay/Probe	Description	Terminal
NO1	NOT USED	NO1, C1
NO2	NOT USED (EXTERNAL ALARM)	NO2, C1
NO3	LIGHT	NO3, C3
NO4	BLOWER	NO4, C3
NO5	HEATER	NO5, C5
NO6	DEFROST ELEMENT (NOT ACTIVE)	NO6, C6
NC6	NOT USED	NC6, C6
S1	AIR/CONTROL PROBE	S1, GND
S2	EVAPORATOR/DEFROST PROBE 1	S2, GND
DI1	DIGITAL INPUT/DOOR SWITCH	DI1, GND
DI2	NOT USED	DI2, GND
S4	EVAPORATOR/DEFROST PROBE 2	S4, GND





DISPLAY CONNECTION



KEYBOARD FUNCTIONS

Note: Keypad has a 3 second lock feature. Press and hold the program button for 3 secs to unlock. All icons will appear when keypad is unlocked

<p>CONTINUOUS CYCLE Press and Release Activate/Stop Continuous Cycle mode</p> 	<p>DEFROST (NOT ACTIVE) Press and Release Activate/Stop Defrost</p> 	<p>HACCP Press and Release View HACCP alarms and HACCP menu</p> 	<p>LIGHT Press and Release Toggle light on and off</p> 
--	---	---	--

<p>ALARM LOG Press and Release View active alarms and alarm menu</p> 	<p>SET/ UP Press and Release Quickly access setpoint adjustment. Scrolls menus and increases values</p> 	<p>PROGRAM (ENTER) Press and Release Used as enter button. Saves Parameter Value Press and Hold (3s) Take the control out of standby. Return to previous parameter</p> 	<p>POWER/ DOWN Press and Release Switch unit on and off. Scrolls menus and decreases values</p> 
---	--	--	--



CHANGING THE OPERATING SETPOINT - CONTROL PANEL

To change the operating set point, press and hold the parameter button for three seconds until the other buttons appear.



Press and release the set button to view the setpoint.

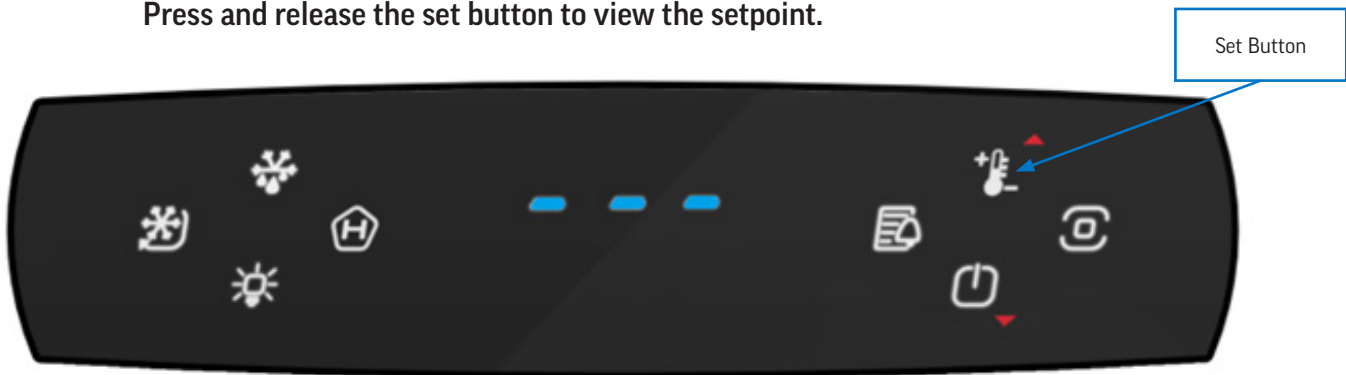

Use the up and down button to change the setpoint. When adjustment is finished, press and release the parameter button to save the change.

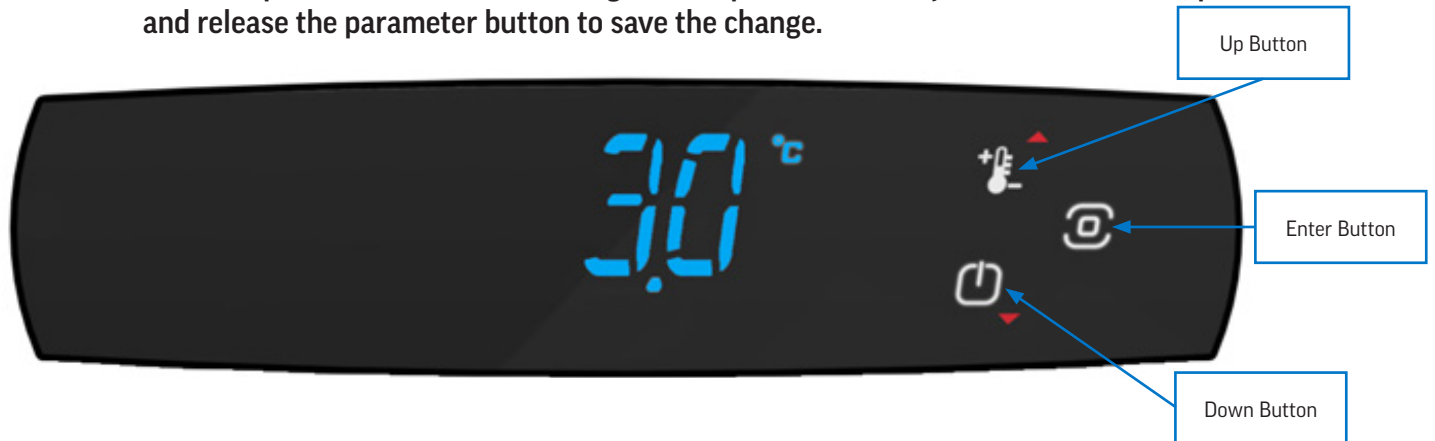

CHANGING THE OPERATING SETPOINT - CAREL APPLICA APP

Open the menu and go to the parameter list.

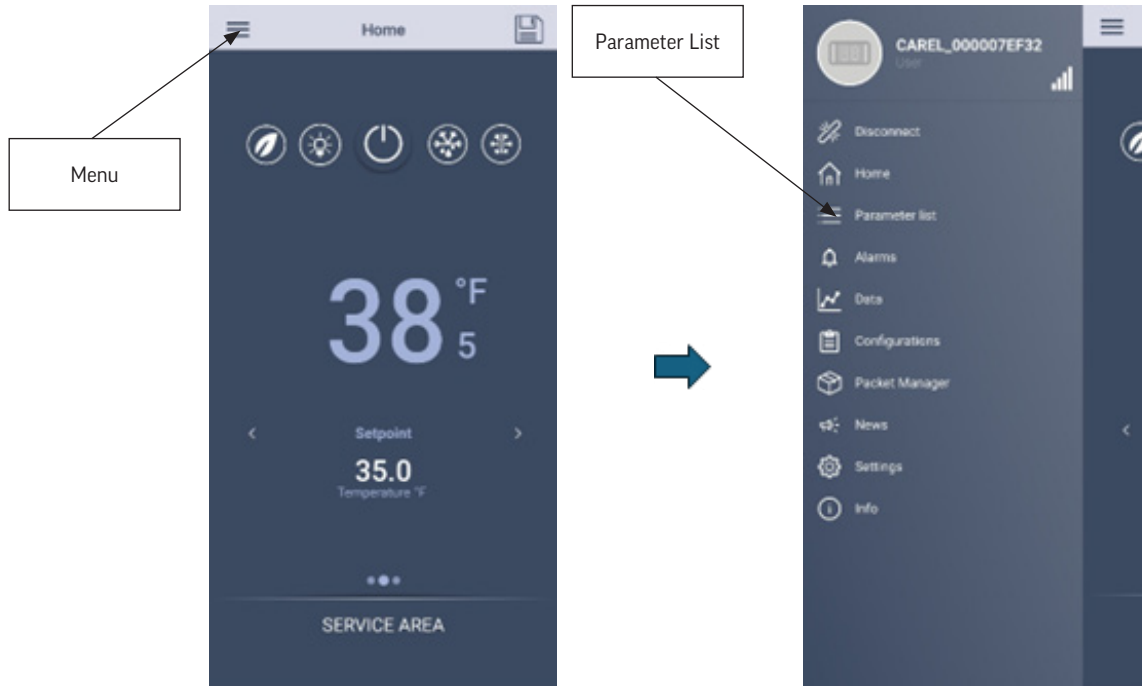

Scroll across the parameter tags and find the one labeled "Temperature Regulation". Select it and change the Setpoint (St).

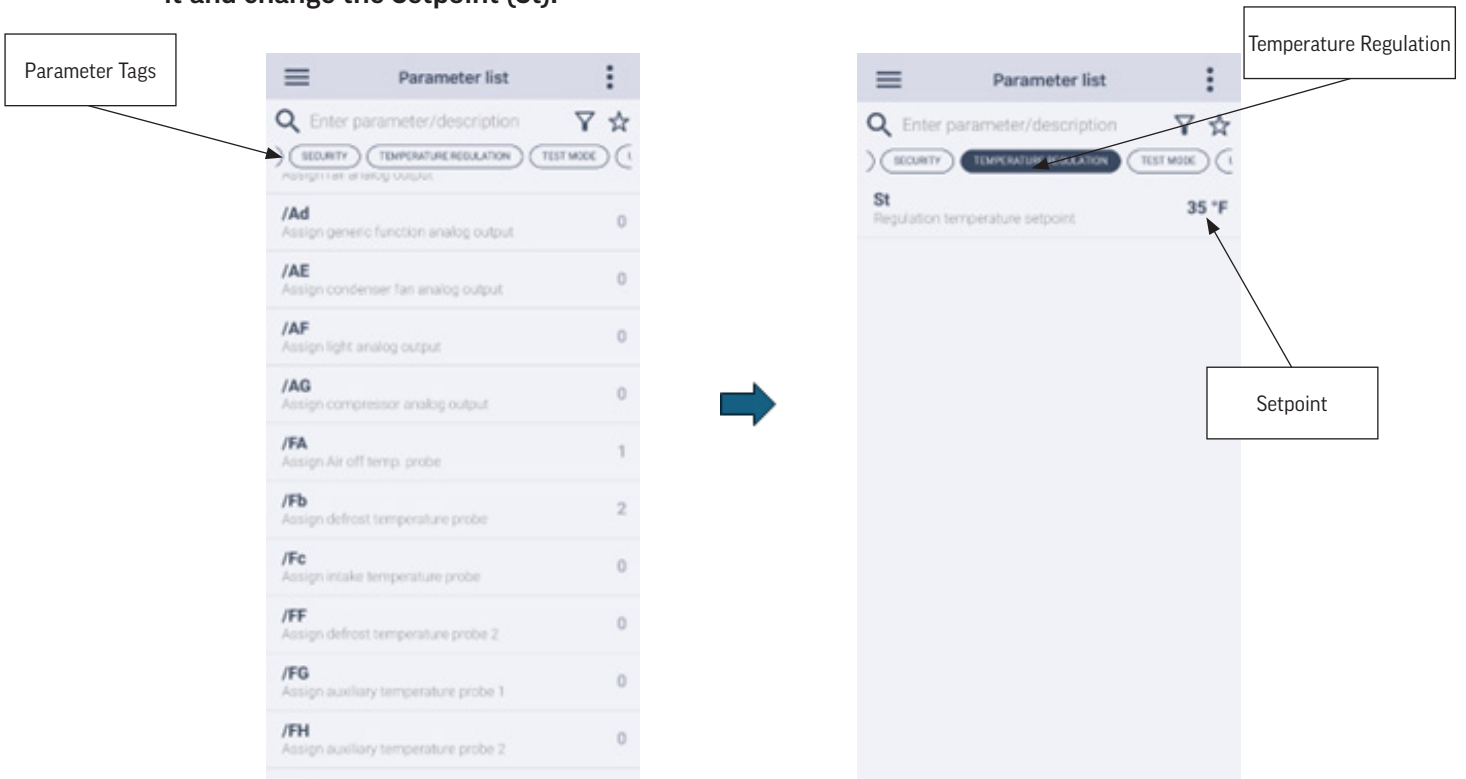

VIEWING ALARM CODES - CONTROL PANEL

To view the alarm codes, press and hold the parameter button for three seconds until the other buttons appear.



Press and release the alarm log button to view the alarm codes.

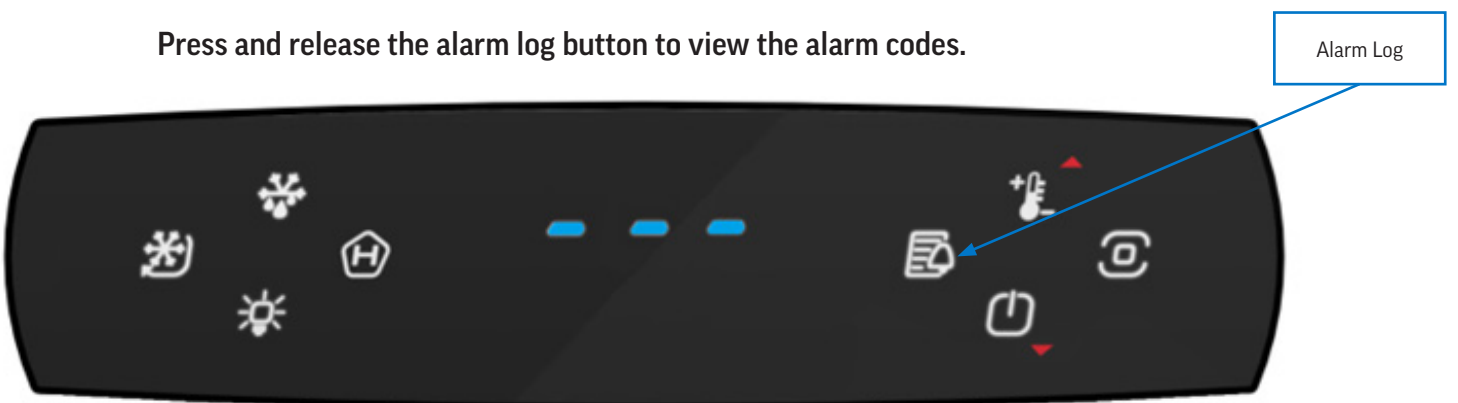

Use the arrows to scroll through the alarm code.

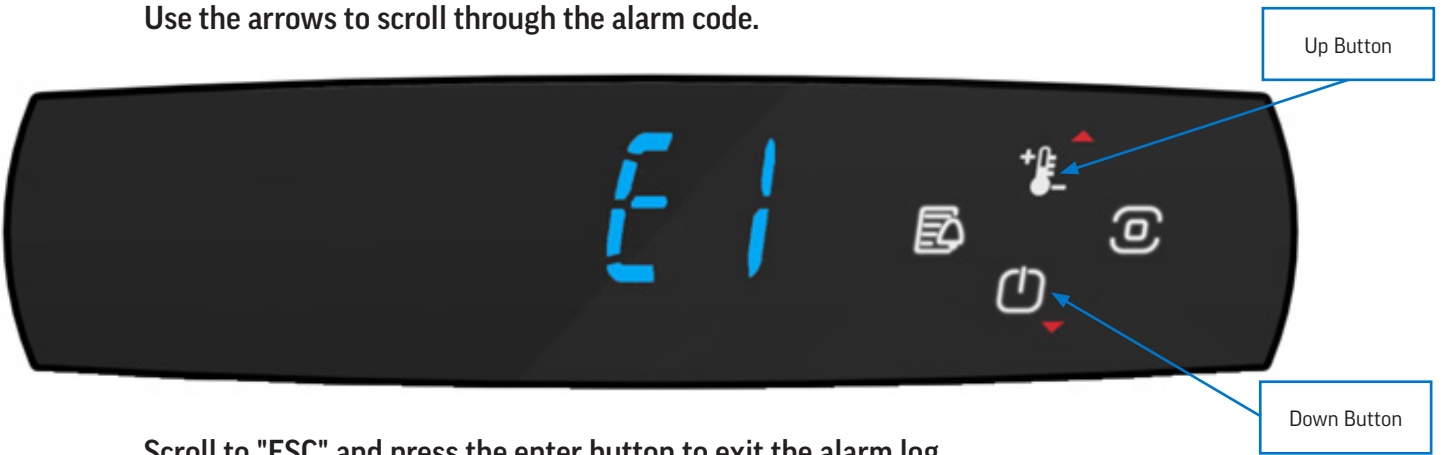

Scroll to "ESC" and press the enter button to exit the alarm log.



VIEWING ALARM CODES - CAREL APPLICA APP

Open the menu and open to the alarms page

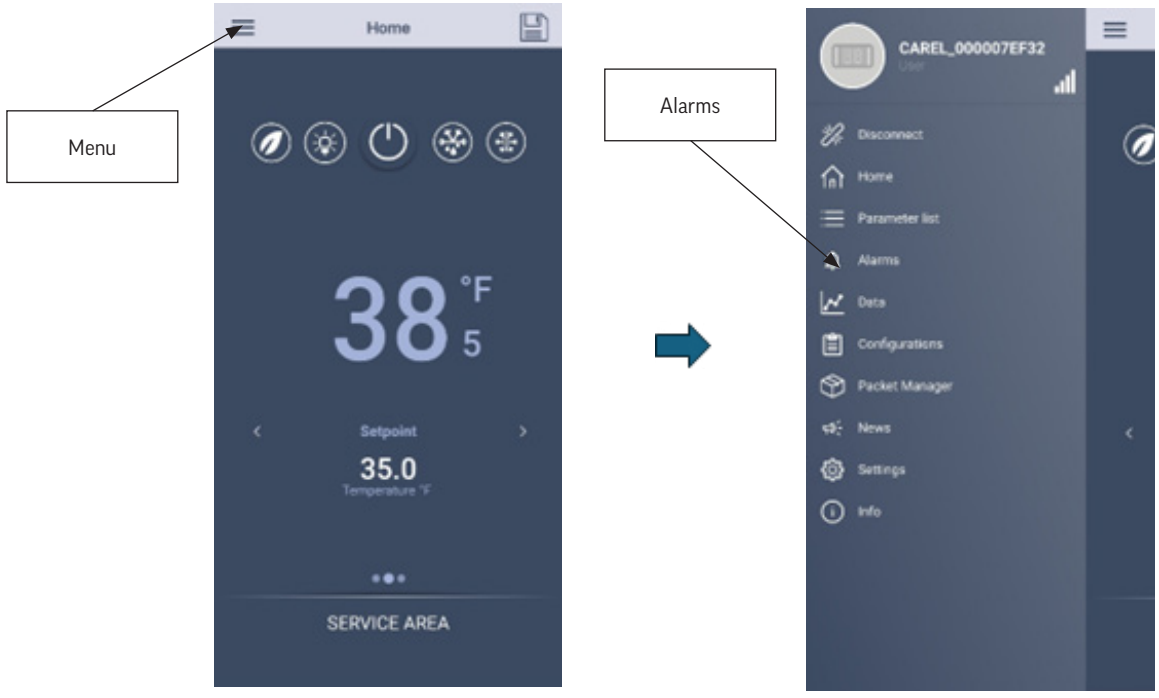

Here you can view active alarm codes and a history of alarms that have gone off.

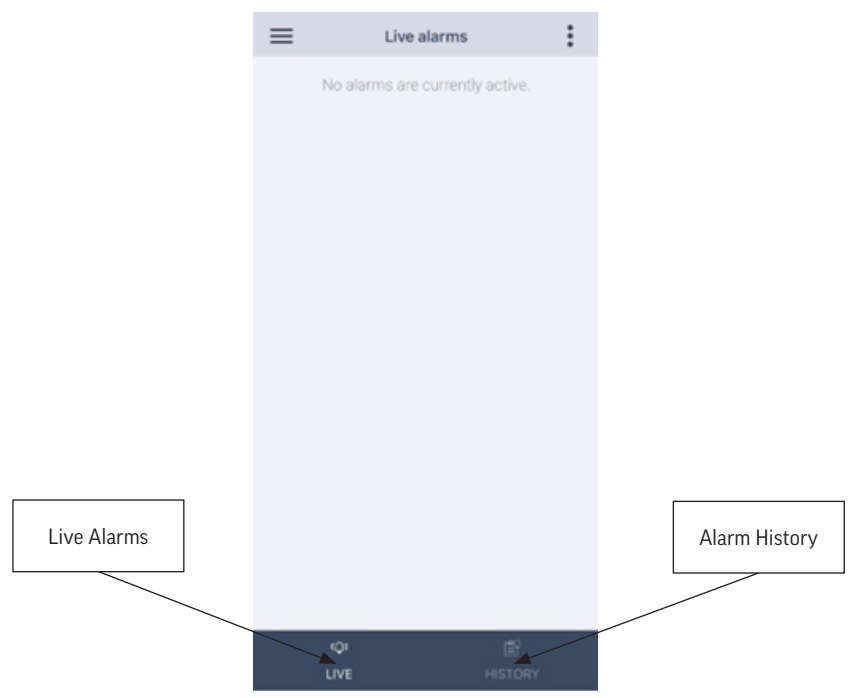

ALARM CODES

Display Code	Log Code	Description	Icon Display	Alarm Relay	Buzzer	Reset	Effects on Control
Afr	29	Frost protection	YES	YES	YES	Automatic	Compressor OFF
AtS	30	Restart in pump down	NO	NO	NO	Automatic	
CE	28	Configuration write error	NO	NO	NO	Automatic	
cht	17	High condensing temperature warning	NO	NO	NO	Automatic	
CHt	18	High condensing temperature alarm	NO	NO	NO	Manual	Compressor OFF
COM	34	VCC communication error	YES	YES	YES	Automatic	
dA	14	Delayed alarm from external contact	YES	YES	YES	Automatic	Compressor operation in duty setting mode (par A6); dead band, lights and auxiliary output OFF
dor	15	Door open	YES	YES	YES	Automatic	See "Door management"
E1	1	Probe 1 faulty or disconnected	NO	NO	NO	Automatic	According to the associated function (see below)
E2	2	Probe 2 faulty or disconnected	NO	NO	NO	Automatic	
E3	3	Probe 3 faulty or disconnected	NO	NO	NO	Automatic	
E4	4	Probe 4 faulty or disconnected	NO	NO	NO	Automatic	
E5	5	Probe 5 faulty or disconnected	NO	NO	NO	Automatic	
E6	6	Probe S1H faulty or disconnected	NO	NO	NO	Automatic	
E7	7	Probe S2H faulty or disconnected	NO	NO	NO	Automatic	
Ed1	10	Defrost terminated after maximum time	NO	NO	NO	Automatic	
Ed2	11	Defrost on second evaporator terminated after maximum time	NO	NO	NO	Automatic	
EHI	36	High power supply voltage alarm	YES	YES	YES	Automatic	
ELO	37	Low power supply voltage alarm	YES	YES	YES	Automatic	
Etc	9	Clock Error	NO	NO	NO	Manual	Time bands disabled

ALARM CODES CONT'D

Display Code	Log Code	Description	Icon Display	Alarm Relay	Buzzer	Reset	Effects on Control
GHI	19	Generic alarm high threshold	YES	YES	YES	Automatic	
GLO	20	Generic alarm low threshold	YES	YES	YES	Automatic	
HA	21	Type HA HACCP alarm (high temp. during operation)	NO	NO	NO	Manual	
HF	22	Type HF HACCP alarm (high temp. after blackout)	NO	NO	NO	Manual	
HI	24	High temperature	YES	YES	YES	Automatic	
IA	13	Immediate alarm from external contact	YES	YES	YES	Automatic	Compressor operation in duty setting mode (par A6); dead band OFF
LO	23	Low temperature	YES	YES	YES	Automatic	
LP	32	Low pressure	YES	YES	YES	Semi-automatic	Compressor OFF
MAn	38	Output status overridden in manual mode	YES	YES	YES	Automatic	
Pd	26	Maximum pump down time	YES	YES	YES	Automatic	
rE	12	Control probe faulty or disconnected	YES	YES	YES	Automatic	Compressor operation in duty setting mode (par c4); dead band OFF
rSF	31	Refrigerant leak alarm	YES	YES	YES	Manual	Switch off all actuators
SF	27	Configuration not completed correctly	NO	NO	NO	Manual	
SrC	35	Maintenance request	YES	YES	YES	Manual	
UCF	33	VCC operation error	YES	YES	YES	Automatic	

CLEANING AND MAINTENANCE

Cleaning Schedule:

Cabinet

Daily wipe down
Weekly interior

Gaskets

Daily inspection, check that hinges are tight to the cabinet.

Routine maintenance

Annually

Daily Exterior Cleaning

It is much easier to clean on a regular basis than to have to remove stains once they have built up.

1. Wash with a clean sponge and a mild detergent that does not contain chlorine.
2. Rinse with clean water.

3. Dry with a soft cloth.
4. Polish with a soft cloth, wiping with the grain.
5. Wipe weekly with stainless steel cleaner.

Weekly Interior Cleaning

1. Remove all food, food related items and shelves. Store the food at a safe temperature.
2. Disconnect power to the unit (unplug it or switch the breaker off).
3. Remove all loose food particles from the inside walls, floor, door liner and ceiling.
4. Scrub all interior surfaces and door gaskets with a warm (100°F to 110°F) detergent solution and a soft scrub brush.

5. Rinse with clean water and allow to air dry.
6. Return the shelves to the unit and secure them.
7. Restore power.
8. Return food to the unit when it has reached a safe temperature.

Periodic, Gaskets

1. Visually inspect the door gaskets for a tight seal on all four sides. Inspect for any type of damage such as rips, tears, stiffness, or cracks.
2. If any such condition exists, the magnet will not seal and the gasket will need replaced.
3. Cleaning the gasket requires the use of mild dish detergent and warm water. Next, thoroughly rinse and dry the gasket.



METHODS FOR CLEANING STAINLESS STEEL

Cleaning Needed	Cleaning Agent	Method of Application	Affect on Finish
Smears and fingerprints	Areal 20, Lac-O-Nu, Lumin Wash O'Cedar Cream Polish, Stainless Shine.	Rub with cloth as directed on the package.	Satisfactory for use on all finishes. Provides barrier film to minimize prints.
Stubborn Spots and Stains, Baked-On Splatter, and Other Light Discolorations	Allchem Concentrated Cleaner.	Apply with damp sponge or cloth. Rub with damp cloth.	Use in direction of polish lines on No. 4 (polished) finish. May scratch No. 2 (mill) and Nos. 7 and 8 (polished) finishes.
	Samae, Twinkle or Cameo Copper Cleaner	Rub with damp cloth.	
	Grade FFF Italian pumice, whiting, or talc.	Rub with dry cloth.	
	Liquid NuSteel Paste NuSteel or DuBois Temp. Copper's Stainless Steel Cleaner Revere Stainless Cleaner Household cleansers, such as Old Dutch, Lighthouse, Sunbrite, Wyandotte, Bab-O, Gold Dust, Sapolio, Bon Ami, Ajax, or Comet Grade F Italian Pumice, Steel Bright, Lumin Cleaner, Zud, Restore, Sta-Clean, or Highlite. Penny-Brite or Copper-Brite.	Use small amount of cleaner. Rub with dry cloth using a small amount of cleaner. Apply with damp sponge or cloth. Rub with a damp cloth. May contain chlorine bleaches. Rinse thoroughly after use. Rub with a damp cloth. Rub with a dry cloth using a small amount of cleaner.	
Heat tint or discoloration	Penny-Brite or Copper-Brite. Past NuSteel, DuBois Temp, or Tarnite. Revere Stainless Steel Cleaner. Allen Polish, Steel Bright, Tenacious Deposits, Rusty Discolorations, Industrial Atmospheric Stains Wyandotte, Bab-O or Zud.	Rub with a dry cloth. Rub with a dry cloth or stainless steel wool. Apply with damp sponge or cloth. Rub with a damp cloth.	
Burnt-On Foods and Grease Fatty Acids, Milkstone (where swabbing or rubbing is not practical)	Easy-Off, De-Grease-It, 4 to 6% hot solution of such agents as trisodium phosphate or sodium tripolyphosphate or 5 to 15% caustic soda solution	Apply generous coating. Allow to stand for 10-15 minutes. Rinse. Repeated application may be necessary.	Excellent removal, satisfactory for use on all finishes.
Tenacious Deposits, Rusty Discolorations, Industrial Atmospheric Stains	Oakite No. 33, Dilac Texo 12, Texo NY, Flash-Klenz, Caddy Cleaner, Turco Scale 4368 or Permag 57.	Swab and soak with clean cloth. Let stand 15 minutes or more according to directions on package, then rinse and dry.	Satisfactory for use on all finishes
Hard Water Spots and Scale	Vinegar. 5% oxalic acid, 5% sulfamic acid, 5 to 10% phosphoric acid, or Dilac, Oakite No. 33, Texo 12, Texo N.Y.	Swab or wipe with cloth. Rinse with water and dry. Swab or soak with cloth. Let stand 10-15 minutes. Always follow with neutralizer rinse, and dry.	Satisfactory for all finishes. Satisfactory for all finishes. Effective on tenacious deposits or where scale has built up.



HELP

PROBLEM	POSSIBLE CAUSE	REMEDY
Cabinet not operating	Fuse blown or circuit breaker tripped	Replace fuse or reset circuit breaker
	Power cord unplugged	Plug in power cord to designated receptacle. Cabinet cannot share same outlet with other equipment.
	Improper voltage supplied to cabinet (voltage does not match Data-Plate).	Correct supply voltage (remove extension cords or other equipment on circuit, etc)
	Main power switch and/or controller turned off	Turn on main power switch and/or controller.
	Defective high limit/heater safety switch	Internal high limit/heater safety may be defective. Contact the factory or an authorized service provider for further assistance if all else has been checked above and the cabinet is still not operating.
Cabinet not holding temperature	Cabinet not pre-heated before use	Turn cabinet on one (1) hour before use
	Prolonged door opening of door ajar	Make sure door is closed when not in use. Avoid prolonged door openings.
	Door gasket not sealing properly	Check door gasket condition Adjust door or replace gasket.
	Controller setpoint is too low	Adjust controller setpoint to a higher temperature
	Improper voltage supplied to cabinet (voltage match Data-Plate)	Correct supply voltage (remove extension cords or does not) other equipment on circuit, etc).
	Product load held too long	Hold product load inside cabinet per recommended temperature. Examples of holding times and temperatures are on page 11.
	Blower motor not operating or air duct is air duct is restricted,	Check blower motor and air duct for proper air flow. Try to carefully locate and remove the cause of air restriction. If further assistance is restricted required, contact the factory or authorized service provider for further assistance.
	Heater elements not operating	Carefully check heater elements for proper operation .If heating element(s) are not working properly, contact the factory or an authorized service provider for further assistance.
Cabinet is overheating.	Defective high limit/heater safety switch	If controller setpoint is adjusted to a lower setting and the internal cabinet temperature exceeds +200' F, turn off cabinet and contact the factory or an authorized service provider for further assistance
	Defective blower motor	Check blower motor operation. If blower motor is not operating, contact the factory or an authorized service provider.

HELP CONTINUED

Product load burning or boiling	Product load is too close to heating element	Rearrange product load so that it is not too close to heating element(s).
	Controller setpoint is too high	Adjust controller setpoint to a lower setting. Examples of holding times and temperatures are within the operator's manual.
Product load becoming soggy	Too much humidity or moisture inside cabinet	Adjust or close internal venting/damper knob to control moisture. Normally the internal venting/damper should be open for products such as breaded meats, fish, etc
	Product load held too long time.	Hold product load inside cabinet per recommended time. Examples of holding times and temperatures are on page 11.
Cabinet is noisy	Part(s) loose	Locate and tighten loose part(s)
	Cabinet is not level	Level cabinet by adjusting legs or shimming caster
Door won't close	Hinge(s) may need slight adjustment	Apply shim(s) to hinge until door seals properly
Controller Alarm & Error	----	Refer to either pages 15 or 19 of manual for alarm codes. If problem(s) persist, contact the factory for further assistance



FOR THE SERVICE TECH - WIRING DIAGRAM

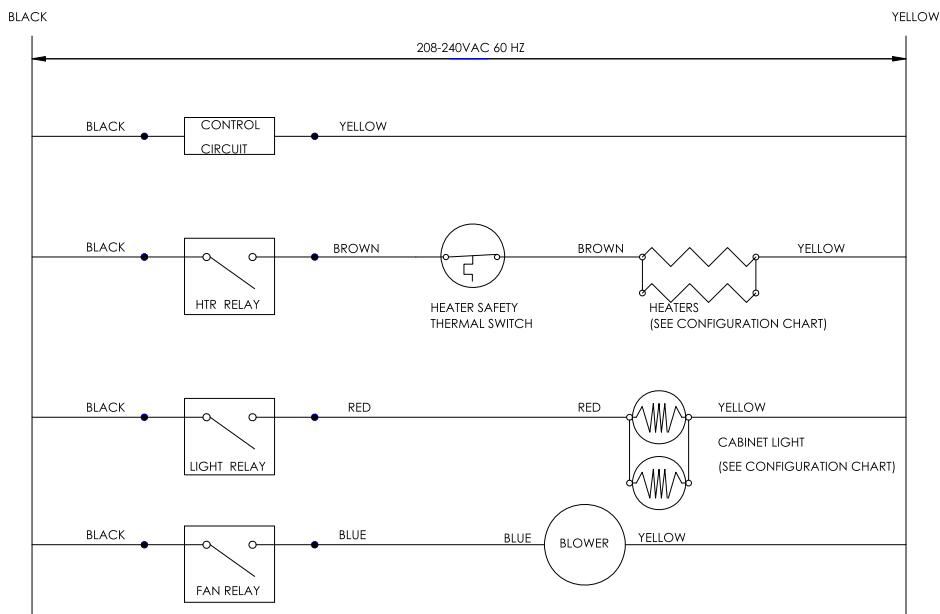

CONFIGURATION CHART		
HEATERS	1 - SECTION	2 - SECTION
	2	4

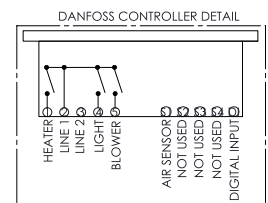
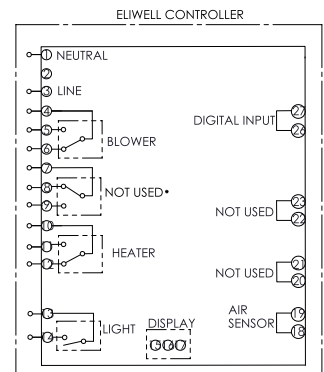

LIMITED WARRANTY

Warranty (Continental USA & Canada Only)

SEVEN (7) YEAR PARTS, LABOR, AND COMPRESSOR LIMITED WARRANTY

Victory® Refrigeration (Victory) warrants to the original purchaser of Victory branded equipment, that such equipment is free from defects in material and workmanship, under normal use, proper maintenance and service as indicated by Victory's installation and operation instructions, for a period of SEVEN (7) years from the date of installation, or eighty-seven (87) months from the date of shipment from the manufacturer, whichever is earlier. In addition, Victory® Refrigeration (Victory) warrants the hermetically/semi-hermetically sealed compressor (part only) for SEVEN (7) years; not to exceed eighty-seven (87) months from the date of shipment from Victory, provided upon receipt of the compressor, manufacturer examination shows the sealed compressor to be defective. This warranty does not cover freight for the replacement compressor or freight for return of the failed compressor. Also, this compressor-part only warranty does NOT apply to any electrical controls, condenser, evaporator, fan motors, overload switch, starting relay, capacitors, temperature control, filter/drier, accumulator, refrigeration tubing, wiring harness, labor charges, or supplies which are covered by the standard warranty above.

*Units shipped after 07/1/2024. Previous warranty applies to units shipped prior.

Exceptions:

- Warranty does not apply for units installed in a Residential application. Units are intended for Commercial use only.
- Blast Chillers carry a 3 year parts and labor warranty; 2 additional years for the compressor.

Normal wear type parts, such as light bulbs/lamps, gaskets, fuses, batteries, blast chiller/freeze probes, thermostat or electronic controller calibration and/or adjustment, and any normal maintenance items as outlined in the Owner's Manual, adjustment of door mechanisms or freight damage are not covered by this warranty. For this warranty, the original purchaser shall be deemed to mean the individual or company for whom the product was originally installed.

Proof of purchase must be supplied to Victory to validate the warranty. This warranty is valid only if equipment is properly installed, and started-up as outlined in the Owner's Manual.

Units that utilize variable speed compressor technology can experience nuisance tripping on Class A GFCI outlets which have a trip limit of 4 mA to 6 mA. To avoid this issue in a location that requires GFCI circuit protection, Beverage Air & Victory recommends using a HUBBELL Model Number GFRST83W 20A Heavy Duty Hospital Grade Self-Test GFCI Receptacle.

Removal or alteration of the serial/ data plate from equipment shall be deemed to release Victory from all warranty obligations or any other obligations, expressed or implied. The warranty does not cover installation, start-up, normal maintenance, food loss, or other consequential damage, and it excludes components that are removable without tools. Our obligation under this warranty shall be limited to repairing or replacing, including labor, any part of such product, which proves defective.

Victory reserves the right to examine any product claimed to be defective. The labor warranty shall be for self-contained units only and for standard straight time, which is defined as normal service rate time, for service performed during normal working hours. Any service requested outside of a servicer's normal working hours will be covered under this warranty at the normal rate and any additional overtime rate will be the responsibility of the equipment purchaser. Victory shall not be responsible for any costs incurred if the work is performed by other than Victory's authorized service personnel. Reimbursement claims for parts and/or labor service costs must be made in writing. Model, cabinet serial number and installation location must be shown on the claim. A receipted bill from the servicing agency must accompany the claim, together with full details of the service problems, diagnosis and work performed. Victory reserves sole discretion whether further documentation on a claim is to be submitted. Any part determined to be defective in the product should be returned to the company within thirty (30) days under the terms of this warranty and must be accompanied by a record of the cabinet model, serial number, with a return material authorization number (RMA#) issued by Victory.

LIMITED WARRANTY (CONTINUED)

Special installation/applications, including remote locations, are limited in coverage by this warranty. Any installation that requires extra work, and/or travel, to gain access to the unit for service is the sole responsibility of the equipment purchaser. Improper operation resulting from factors, including but not limited to, improper or negligent cleaning and maintenance, low voltage conditions, inadequate wiring, outdoor use and accidental damage are not manufacturing defects and are strictly the responsibility of the purchaser.

Except Blast Chillers, a product is designed for maintaining temperature and not bringing food to a desired temperature, so cannot be held responsible for this function under warranty.

Units must be in conditioned environments or warranty will be void.

Condenser coils must be cleaned at regular intervals. Failure to do so can cause compressor malfunction and will void warranty. Although cleaning requirements vary in accordance with the operation of various products, Victory recommends a minimum monthly cleaning.

NOTE: NO CLAIMS CAN BE MADE AGAINST THESE WARRANTIES FOR SPOILAGE OF PRODUCTS, LOSS OF SALES OR CONSEQUENTIAL DAMAGES. THE FOREGOING WARRANTIES ARE EXPRESSLY GIVEN IN LIEU OF ALL OTHER WARRANTIES, EXPRESS, IMPLIED, OR STATUTORY, INCLUDING THE IMPLIED WARRANTIES OF MERCHANTABILITY AND FITNESS FOR A PARTICULAR PURPOSE, WHICH ARE HEREBY DISCLAIMED, AND ALL OTHER OBLIGATIONS OR LIABILITIES ON OUR PART, AND WE NEITHER ASSUME, NOR AUTHORIZE ANY OTHER PERSON TO ASSUME FOR US, ANY OBLIGATION OR LIABILITY IN CONNECTION WITH THE SALE OF SAID REFRIGERATION UNITS OR ANY PARTS THEREOF.

These warranties shall not be assignable and shall be honored only in so far as the original purchaser.

These warranties do not apply outside the limits of the USA and Canada, nor do they apply to any part that has been subject to misuse, neglect, alteration, accident, or to any damage caused by transportation, flood, fire, acts of terrorism, or acts of God.

LIMITATION OF LIABILITY:

Victory or its affiliates shall not be liable for any indirect, incidental, special or consequential damages, or losses of a commercial nature arising out of malfunctioning equipment or its parts or components thereof, because of defects in material or workmanship. In no event shall Victory be liable for a sum more than the purchase price of the item.

THE ORIGINAL OWNER'S SOLE AND EXCLUSIVE REMEDY AND VICTORY'S SOLE AND EXCLUSIVE LIABILITY SHALL BE LIMITED TO THE REPAIR OR REPLACEMENT OF PARTS OR COMPONENTS CONTAINED IN THE EQUIPMENT IDENTIFIED ABOVE WHICH UNDER NORMAL USE AND SERVICE MALFUNCTION AS A RESULT OF DEFECTS IN MATERIAL OR WORKMANSHIP, SUBJECT TO THE APPLICABLE PROVISIONS AND LIMITATIONS STATED ABOVE.

07/2024

Warranty Registration

Register your product online at victoryrefrigeration.com/parts-service or fill out and mail the form below.

Cabinet Model Number: _____ Date Of Installation: _____

Cabinet Serial Number: _____

Location Of Product

Business Name: _____

Business Street: _____

Business City: _____ State: _____ Postal Code: _____

Mail to: Victory, 3779 Champion Blvd, Winston-Salem, NC 27105

Rev. 02/26

