

newair®

Quietheat15/15B/15S

Portable Ceramic Space Heater



OWNER'S MANUAL

Read and save these instructions.



A Name You Can Trust

Trust should be earned and we will earn yours. Customer happiness is the focus of our business.

From the factory to the warehouse, from the sales floor to your home, the whole NewAir family promises to provide you with innovative products, exceptional service, and support when you need it the most.

Count on NewAir.

As a proud NewAir owner, welcome to our family. There are no robots here, real people shipped your product and real people are here to help you.

Contact Us:

For questions regarding your product, please contact us at:

Call: 1-855-963-9247
Email: support@newair.com
Online: www.newair.com

Connect with Us:



facebook.com/newairusa



instagram.com/newairusa



youtube.com/newairusa



twitter.com/newairusa

READ AND SAVE THESE INSTRUCTIONS.

TABLE OF CONTENTS

Register Your Product Online.....	Error! Bookmark not defined.
Safety Information & Warnings	5
Parts List.....	10
Operating Instructions	11
Maintenance And Cleaning.....	15
Limited Manufacturer's Warranty	16

SPECIFICATIONS

MODEL NO:	Quietheat15/15B/15S
COLOR:	White
PRODUCT DIMENSIONS:	13.86" x 7.2" x 13.7"
VOLTAGE:	120V
FREQUENCY:	60Hz
POWER:	1000W/1500W
NOISE LEVEL (dB):	≤45dB
CERTIFICATIONS:	ETL
WARRANTY:	1 Year Manufacturer's Warranty

REGISTER YOUR PRODUCT ONLINE

Register Your NewAir Product Online Today!

Take advantage of all the benefits product registration has to offer:



Service and Support

Diagnose troubleshooting and service issues faster and more accurately



Recall Notifications

Stay up to date for safety, system updates and recall notifications



Special Promotions

Opt-in for NewAir promotions and offers

Registering your product information online is safe & secure and takes less than 2 minutes to complete:

register.newair.com

Alternatively, we recommend you attach a copy of your sales receipt below and record the following information, located on the manufacturer's nameplate on the rear of the unit. You will need this information if it becomes necessary to contact the manufacturer for service inquiries.

Date of Purchase: _____

Serial Number: _____

Model Number: _____

SAFETY INFORMATION & WARNINGS



These instructions are not meant to cover every possible condition and situation that may occur. Please read all instructions before using this evaporative cooler. Failure to carefully read all instructions may result in possible electric shock or fire hazard, and will void the manufacturer's warranty.

Read all instructions carefully, even if you are quite familiar with the appliance.

- Children that are eight years old or older and persons with reduced physical, sensory, or mental capabilities, or lack of experience and knowledge can use this appliance, if they have been given supervision or instruction concerning the use of the appliance in a safe way and understand the hazards involved. Children should not play with the appliance.
- Children should not do cleaning and user maintenance without supervision.
- Children less than three years old should be kept away from the space heater, if not continuously supervised.
- Children from eight years of age or older can only turn the appliance on/off, in instances where it has been placed or installed in its predetermined normal operating position and the children have been given supervision or instruction concerning the use of the appliance in a safe way and understand the hazards involved.
- Children should not be responsible for the plugging, regulating, and cleaning the appliance, or performing user maintenance.
- Some parts of this product may become very hot and cause burns. Particular attention should be given when children and vulnerable people are operating the machine.
- If the supply cord is damaged, the manufacturer to avoid a hazard must replace it.
- **WARNING:** To avoid overheating, do not cover the heater.
- The heater must be located immediately after an outlet or a socket.
- Do not use this heater close to a bathtub, shower, or a swimming pool.





SAVE THESE INSTRUCTIONS!

SAFETY WARNINGS AND PRECAUTIONS





In order to use the product more conveniently and avoid any danger caused by the misuse, please pay a close attention to the notices instructed by signs hereinafter, and read the instructions carefully.



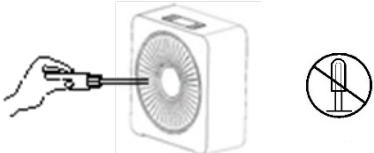
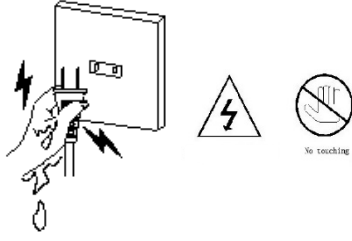

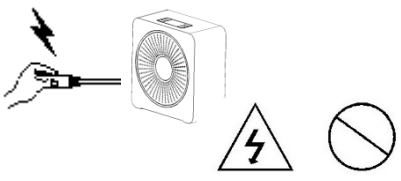
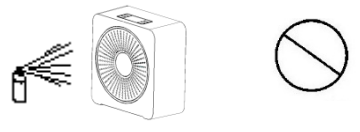
SYMBOL INTRODUCTION

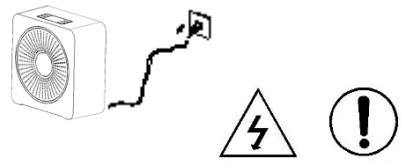
 <p>Warning</p>	<p>Refusing to follow these instructions can cause serious injury to the user</p>
 <p>Forbidden</p>	<p>Action is prohibited at all costs</p>
 <p>Must Obey</p>	<p>Follow exactly as instructed</p>

WARNINGS AND PRECAUTIONS

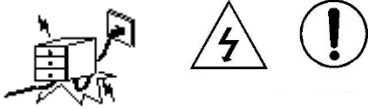
<ul style="list-style-type: none"> With any indication of malfunction, contact the service center for repairs. Do not attempt to disassemble the product or replace faulty parts with unauthorized components because it will damage the unit. 	<ul style="list-style-type: none"> Do not handle the plug or product with wet hands because it may cause electric shock. 
---	---

<ul style="list-style-type: none">Do not put sticks, metal, or other objects into the outlet because it will cause a "short circuit," or even damage the device. 	<ul style="list-style-type: none">Do not use pesticides, or other flammable sprays, around this product because it will damage the device. 
<ul style="list-style-type: none">Do not face the wind outlet to a baby directly for a long time because it is hazardous to the baby's health. 	<ul style="list-style-type: none">Do not pull the wires when unplugging the power cord plug because it will damage the wire, or cause a malfunction. 
<ul style="list-style-type: none">Make sure there are no abnormal items in the wire, and the plug is well plugged in, otherwise it will cause a malfunction of the device. 	<ul style="list-style-type: none">When there is an unusual smell, or an unusual sound from the device, stop operating the device and unplug it. 

<ul style="list-style-type: none"> Do not break the power cord, or you may risk an electric shock, short circuit, or a fire outbreak. Please contact the service center for repairs 	<ul style="list-style-type: none"> Do not fold the power cord, or place heavy objects on it, because it can cause the device to malfunction. 
<ul style="list-style-type: none"> Switch off the device and unplug the power cord when not in use for a long time. Precaution should be observed when operating around a child, or an animal. 	<ul style="list-style-type: none"> Use a power outlet that meets inspection requirements, and makes sure the carrying capacity of the socket is less than 10A/220V. Ensure the power supply voltage is consistent with the specified voltage in the machine (AC 220V). 
<ul style="list-style-type: none"> Make sure of the service voltage when relocating. Using the device around the tub, sprinkler, or swimming pool is not advisable. Using the device directly below the power outlet is not advisable. 	<ul style="list-style-type: none"> Do not use the device close to the walls, curtains, or other combustible materials to avoid the risk of a fire outbreak. To avoid overheating, do not cover the device with a heater. Never place any objects in the device 

WARNINGS AND PRECAUTIONS

1. Do not place any objects such as furniture, papers, clothes, and curtains in front of the heater. There must be at least 3 feet of space between any object and the front of the heater. Keep anything away from the sides and rear when the heater is working.
2. Do not place the heater near a bed, because objects such as pillows or blankets can fall off the bed and be ignited by the heater.
3. Always unplug the heater when not in use.
4. Do not operate the heater if the supplied wire and/or plug are damaged.
5. To disconnect the heater, turn controls off and then remove the plug from the outlet.
6. Do not insert or allow foreign objects to enter any ventilation or exhaust opening as this may cause an electric shock, fire, or damage the heater.
7. To prevent a possible fire outbreak, do not block air intakes or exhaust in any manner. Do not use on soft surfaces, like a bed, where openings may become blocked.
8. A heater has hot, arcing or sparking parts inside. Do not use it in areas where gasoline, paint, or flammable liquids are used or stored.
9. Use this heater only as described in this manual. Any other use not recommended by the manufacturer may cause fire, electric shock, or injury to persons.
10. Always plug heaters directly into a wall outlet/receptacle. Never use with an extension cord or relocatable power tap (outlet/power strip)

PARTS LIST

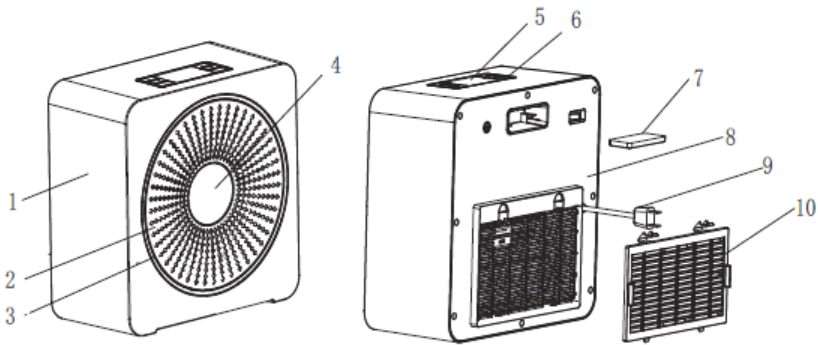

- | | |
|-----------------------|-----------------------|
| 1. Front shell | 6. Electronic buttons |
| 2. Mesh grill support | 7. Remote control |
| 3. Mesh grill | 8. Back Cover |
| 4. CD stripe | 9. Power cord |
| 5. Display | 10. Air inlet |

FEATURES

1. It is a ceramic heating element that changes power automatically according to the variation of the ambient temperature
2. High and low heating power
3. Small and exquisite machine body with handle making it easy to carry
4. A dismountable dust filter structure that thoroughly filters the dust in the air
5. An automatic wing outlet with a soft wind that heats evenly
6. Uses a shaded pole motor and tubular wind wheel, which makes the device function with high thermal efficiency and low noise
7. Safety features such as, double overheating protection and tip over safety protection
8. Convenient operation with infrared remote control
9. ECO function, to save energy

OPERATING INSTRUCTIONS

Take the space ceramic heater out of the package. Ensure that you receive all the items with your unit as mentioned in the parts list section. Carefully place the space ceramic heater on a stable surface/floor and make sure the control display is facing upward.



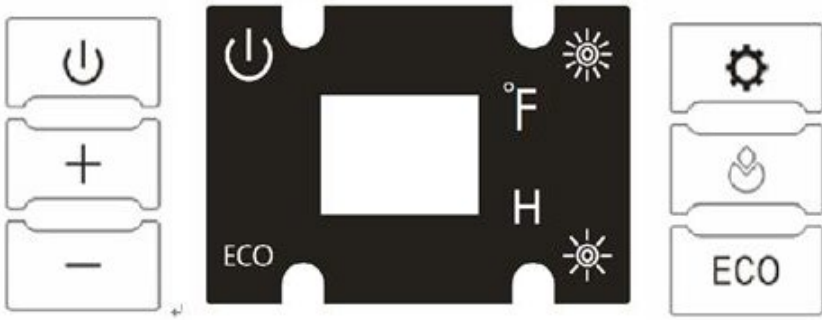



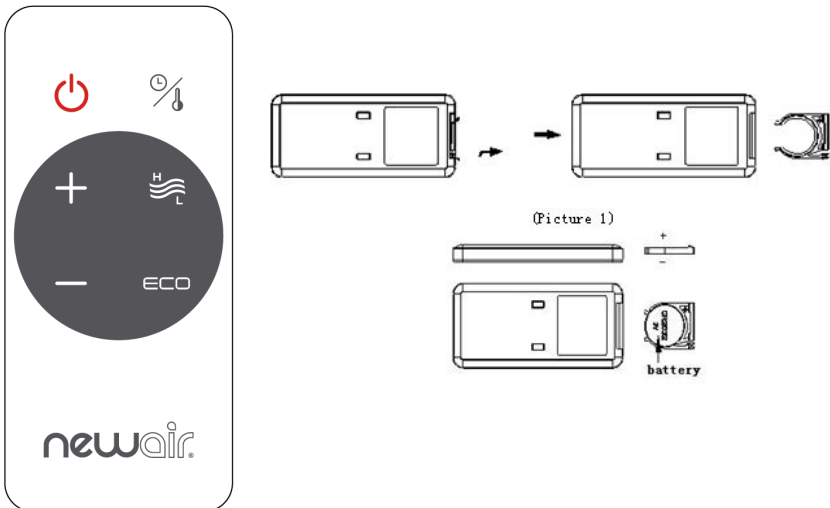







OPERATION PANEL



















REMOTE CONTROL PANEL AND BATTERY





BUTTON FUNCTIONS

1. Check and make sure the plug voltage is by 120V, then plug in.
2. When plugged in, the buzzer will beep, and the heater will enter the standby mode, the power indicator will be on, and all other functions on display will be off.
3. When on standby mode, all keys will be invalid, except the  key. Press the  key and the device will start working. To turn the machine off, press the power button again and the device will start a countdown and switch off. The default setting after it is turned on is shown below:
 - a. The  indicates the low heating power
 - b. The  displays the default temperature
4. Once the unit is on and showing the default settings, press the  key to shift from low heating power to high heating power. If you press it again, it will go back to the lower heating power.
 - a. When the unit is operating at low heating power, the low heating power indicator  will show on the display and the high heating power indicator  will not.
 - b. When the unit is operating at high heating power, the high heating power indicator  will show on the display and the low heating power indicator  will not.
5. After deciding the desired heating power  (low) or  (high), the timer and temperature can be set. The  key let you control the timer and temperature on the unit. Once the timer and temperature are set, the desired heating power will remain at the desired heating power in the previous step. If the heating power needs to be changed from low to high or high to low just press the  key once.
 - a. By pressing the  key once, the LED light will start flickering (It will go to the default standby mode in five seconds) at this time you will be

able to set the timer between 0-12 hours by pressing on the  (to increase time) or  (to decrease time).

- i. The time will be added or subtracted by one hour with every press, when you press the  or  key, and the press length is more than two seconds.
 - ii. You can reset the time by pressing the  key once and the timer starts flickering, then press the  or  key and the timer that you set will take effect.
- b. By pressing the  key twice, the temperature indicator  key will show and the LED light will start flickering (It takes five seconds for it to go to the default standby mode) at this time you will be able to set the temperature anywhere between 41 °F - 95 °F by pressing the  (to increase the temperature) or  (to decrease the temperature).
- i. The temperature will be add or subtract 1°F with every press when you press the  or  key, and the press length is more than two seconds.
 - ii. You can reset the temperature by pressing the  key twice, then press the  or  key and to set the timer.

NOTE: If there is no response to the keys after five seconds, or other keys are pressed, except the , , or  keys, the digital tube will display the temperature being set right away.

- c. After turning on the machine, the temperature function will be activated within ten seconds. After ten seconds, if the temperature is above the set temperature (+ 5°F), the space heater will be turned off and the heating power wattage will not be displayed. The fan will turn off after ten seconds (if previously turned on), then display the set temperature. If the temperature is below the set temperature (-5°F), the space heater and fan will restart (if the fan is already running, then within the ten seconds delay time, the fan will continue to work), and the heating power wattage will be displayed.

- When setting the time and temperature at the same time, timing and the room temperature display interactively at intervals of thirty seconds. Meaning the timer display will show for thirty seconds and the temperature display will be off. Then the temperature display will show for thirty seconds and the timer display will be off. When the timing is not set, only the setting temperature will display.

ECO MODE

When the space heater is on, press the  key to shift the product into the ECO mode.

The indicator  will switch to the default temperature between 64°F to 75°F. The PCT will stop working when the temperature is higher than 75°F. At the same time, the fan will stop working after rotating for ten seconds with high speed. The fan will work with high speed when the temperature is lower than 64°F. The fan will work with low speed when the temperature is between 64°F and 75°F.

FAN COOLING FUNCTION

The fan will start to work when the heating power fan starts to work and the fan will continue to function for ten seconds after the heating power fan stops working. The numbers 10, 9, 8, 7, ... 0 will be displayed. During this ten seconds after shutting down the machine, the fan and the heating power fan will turn off at the same time.

CONTINUOUS ELECTRIC MEMORY FUNCTION

- Under standby mode, press the  key and the unit will keep working with the same status as the last setting, except the timing function.
- The machine will work in a continuous mode after one minute and the brightness of the display section should be reduced to one-third of the normal brightness, solving the problem of the LED-lamp shining in the night. It will restore the brightness after operation.
- When the machine is tipped over during operation, the heating power stops and the wind wheel will work for ten seconds and stop. The machine will then go into the standby mode.

MAINTENANCE AND CLEANING

1. Before cleaning, unplug the device and make sure the heater cools off.
2. Use a soft cloth to wipe the dust on the heater. If the surface is too dirty, it is better to clean it with warm water, mixed with a neutral detergent.
3. Do not use gasoline, thinner, and any other solvents that may easily damage the surface.
4. Cool and dry the heater before packing, and place it in a dry and well-ventilated place.

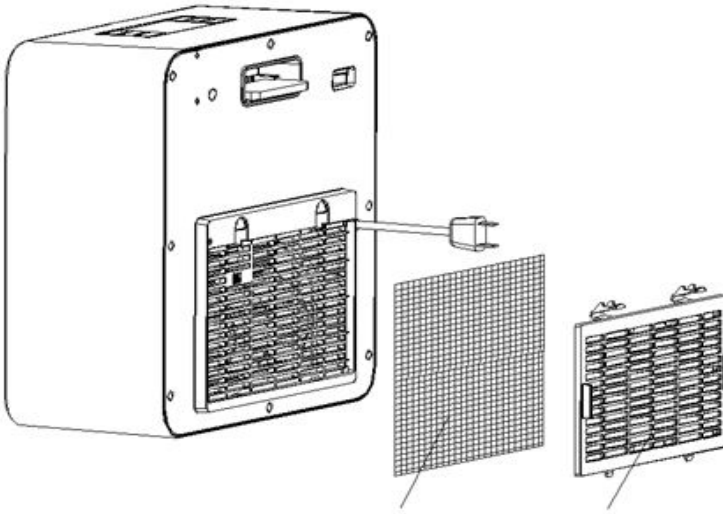

ELECTRICAL SCHEMATIC DIAGRAM

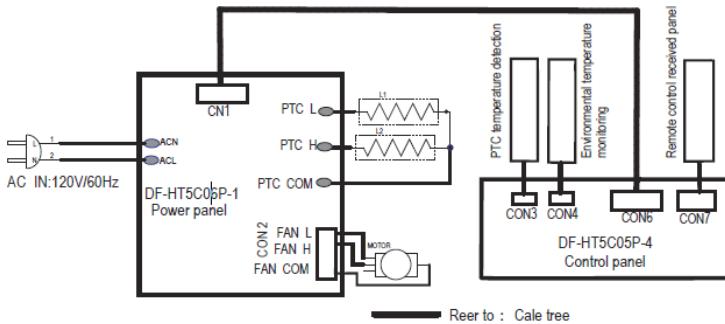

LIMITED MANUFACTURER'S WARRANTY

This appliance is covered by a limited manufacturer's warranty. For one year from the original date of purchase, the manufacturer will repair or replace any parts of this appliance that prove to be defective in materials and workmanship, provided the appliance has been used under normal operating conditions as intended by the manufacturer.

Warranty Terms:

During the first year, any components of this appliance found to be defective due to materials or workmanship will be repaired or replaced, at the manufacturer's discretion, at no charge to the original purchaser. The purchaser will be responsible for any removal or transportation costs.

Warranty Exclusions:

The warranty will not apply if damage is caused by any of the following:

- Power failure
- Damage in transit or when moving the appliance
- Improper power supply such as low voltage, defective household wiring or inadequate fuses
- Accident, alteration, misuse or abuse of the appliance such as using non-approved accessories, inadequate air circulation in the room or abnormal operating conditions (extreme temperatures)
- Use in commercial or industrial applications
- Fire, water damage, theft, war, riot, hostility or acts of God such as hurricanes, floods, etc.
- Use of force or damage caused by external influences
- Adjustments to temperature by removal of sticker and/or screw
- Partially or completely dismantled appliances

Obtaining Service:

When making a warranty claim, please have the original bill of purchase with purchase date available. Once confirmed that your appliance is eligible for warranty service, all repairs will be performed by a NewAir™ authorized repair facility. The purchaser will be responsible for any removal or transportation costs. Replacement parts and/or units will be new, re-manufactured or refurbished and is subject to the manufacturer's discretion. For technical support and warranty service, please email support@newair.com