

OWNERS MANUAL

MODELS

U.S. – CRE9830B, CRE9530B, CHE9830B

CANADA – CRE9830C, CRE9530C

TABLE OF CONTENTS

| | Page |
|--|------------|
| For Future Reference | 1 |
| Important Safety Instructions | 2-4 |
| Range Control Panel | 5-6 |
| • Electronic Clock and Oven Control | 5-6 |
| • Setting the Clock and Timer | 6 |
| Surface Cooking | 7-9 |
| • Panel Light | 7 |
| • The Controls | 7 |
| • Suggested Heat Settings | 7 |
| • Using Your Ceramic Glass Surface (select models) | 8 |
| • Using Your Coil Element Surface (select models) | 9 |
| Using Your Oven | 10-13 |
| • Baking and Roasting | 10-11 |
| • Broiling | 12 |
| • Programmed Oven Operations | 12-13 |
| Care and Cleaning | 14-17 |
| • Ceramic Glass Surface (select models) | 14 |
| • Coil Element Surface (select models) | 14 |
| • Self-Clean Oven | 14-15 |
| • Range Cleaning Chart | 16-17 |
| Maintenance | 18-19 |
| • Adjusting the Oven Thermostat | 18 |
| • Storage Drawer | 18 |
| • Leveling Legs | 18 |
| • Light Replacement | 19 |
| • Oven Door | 19 |
| Before You Call for Service | 20 |
| Warranty | Back Cover |



FOR FUTURE REFERENCE

Congratulations on your choice of a Maytag range. As you use your new range we know you will appreciate the many features that provide excellent performance, the convenience of convection, ease of cleaning and dependability.

Read this manual. New features have dramatically changed today's cooking appliances and the way we cook. It is therefore very important to understand how your new range operates. On the following pages you will find information regarding its operation. By following these instructions carefully, you will be able to fully enjoy and properly maintain your new Maytag range.

Save time and money. Please take a moment to review the enclosed booklet, "**Cooking Made Simple.**" Whether you need assistance in selecting the right cookware or reviewing the "dos and don'ts" of baking, roasting and broiling, the answers are contained in this booklet. If something goes wrong, check the "Before You Call for Service" section of this manual. It is designed to solve common problems you may encounter.

Should you have any questions about using your Maytag range, call or write us. Be sure to provide the model and serial numbers of your range.

MAYTAG CONSUMER EDUCATION
 ONE DEPENDABILITY SQUARE
 NEWTON, IOWA 50208
 (515) 791-8911
 (Mon-Fri., 8 am-5 pm CST)
 Internet: <http://www.maytag.com>

For future reference, keep this manual in a convenient location. Record the model number, serial number and purchase date of your range in the spaces provided. (This information can be found on the data plate located on the frame around the storage drawer.)

| |
|--------------|
| Model Number |
|--------------|

| |
|---------------|
| Serial Number |
|---------------|

| |
|---------------|
| Purchase Date |
|---------------|

IMPORTANT: Keep your sales receipt or canceled check. Proof of original purchase date is needed for warranty service.

NOTE: In our continuing effort to improve the quality and performance of our cooking products, it may be necessary to make changes to the appliance without revising this manual.

BE SURE YOU READ THE SAFETY INSTRUCTIONS ON PAGES 2-4 BEFORE YOU START TO USE THIS RANGE.

IMPORTANT SAFETY INSTRUCTIONS

Read all instructions before using this appliance.

The following instructions are based on safety considerations and must be strictly followed to reduce the potential risks of fire, electric shock, or personal injury.

Be sure appliance is properly installed and grounded by a qualified technician.

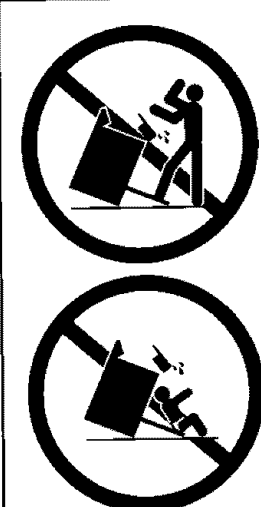
| | |
|--|--|
|  | <p>! WARNING</p> <ul style="list-style-type: none">• ALL RANGES CAN TIP• INJURY TO PERSONS COULD RESULT• INSTALL ANTI-TIP DEVICES PACKED WITH RANGE• SEE INSTALLATION INSTRUCTIONS |
|--|--|

WARNING: To reduce the risk of tipping of appliance from abnormal usage or by excessive loading of the oven door, the appliance must be secured by a properly installed anti-tip device. When removing the appliance for cleaning, be sure the anti-tip device is engaged when the range is replaced. Look underneath range to verify that one of the rear leveling legs is properly engaged in the bracket slot. The anti-tip device secures the rear leveling leg to the floor when properly engaged.

Do not attempt to adjust, repair, service, or replace any part of appliance unless it is specifically recommended in this book. All other servicing should be referred to a qualified servicer. Always disconnect power to unit before any servicing by tripping circuit breaker to the OFF position or removing the fuse.

Locate and mark the breaker or fuse. Never replace a blown fuse or reset a breaker until you know what has caused the problem. Always replace a blown fuse with one of the correct amperage.

To Prevent Fire or Smoke Damage

Remove all packing materials from the appliance before operating it.

Flammable materials should not be stored in an oven or on or near surface elements.

If appliance is installed near a window, proper precautions should be taken to prevent curtains from blowing over surface elements.

Do not leave any items on the cooktop. The hot air from the vent may ignite flammable items and may increase pressure in closed containers which may cause them to burst.

Many aerosol-type spray cans are **EXPLOSIVE** when exposed to heat and may be highly flammable. Avoid their use or storage near an appliance.

Do not leave plastic items on the cooktop as they may melt or soften if left too close to the vent or surface element.

To eliminate the hazard of reaching over hot surface elements, cabinet storage should not be provided directly above a unit. If such storage is provided, it should be limited to items which are used infrequently and which are safely stored in an area subjected to heat from an appliance. Temperatures may be unsafe for some items, such as volatile liquids, cleaners or aerosol sprays.

In Case of Fire

Turn off appliance and ventilating hood to avoid spreading the flame.

Use dry chemical or foam-type extinguisher or baking soda to smother fire or flame. Never use water on a grease fire.

If fire is in the oven or broiler pan, smother by closing oven door.

If fire is in a pan on the surface element, cover pan. Never attempt to pick up or move a flaming pan.

Child Safety

Do not leave children alone or unsupervised near the appliance when it is in use or is still hot.

Children must be taught that the appliance and utensils in or on it can be hot.

Children should be taught that an appliance is not a toy. Children should not be allowed to play with controls or other parts of the unit. Children should never be allowed to sit or stand on any part of the appliance.

CAUTION: Do not store items of interest to children in cabinets above an appliance or on the backguard of a range. Children climbing on the appliance or on the appliance door to reach items could be seriously injured.

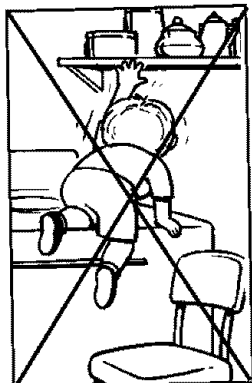

Never heat an unopened food container. Pressure build-up may cause container to burst resulting in personal injury or damage to the appliance.

Use dry, sturdy potholders. Damp potholders on hot surfaces may cause burns from steam. Towels or other bulky items should never be used as potholders. Do not let potholders touch hot heating elements.

Always let quantities of hot fat cool before attempting to move or handle.

Do not let grease or other flammable materials accumulate in or near the appliance, hood or vent fan. Clean hood frequently to prevent grease from accumulating on hood or filter.

Make sure the drip bowls are in place (select models). Absence of these bowls during cooking may subject wiring or components underneath to damage.

Ceramic glass cooktop (select models): Do not cook on a broken cooktop. Cleaning solutions and spillovers may penetrate the broken cooktop and create a risk of electric shock. Contact a qualified technician immediately.

Loose fitting or long hanging-sleeved apparel should not be worn while cooking. Clothing may ignite or catch utensil handles.

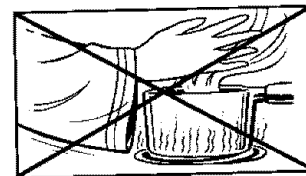

Always place oven racks in the desired positions while oven is cool. If a rack must be moved while hot, use a dry potholder and avoid touching hot element in oven.

Use care when opening the oven door. Let hot air or steam escape before removing or replacing food.

PREPARED FOOD WARNING: Follow food manufacturer's instructions. If a plastic frozen food container and/or its cover distorts, warps, or is otherwise damaged during cooking, immediately discard the food and its container. The food could be contaminated.

DO NOT TOUCH THE SURFACE OR OVEN ELEMENTS, AREAS NEAR THE ELEMENTS OR THE INTERIOR SURFACES OF OVEN. Elements may be hot even though they are dark in color. Areas near surface elements and the interior surfaces of the oven may become hot enough to cause burns. During and after use, do not touch or let clothing or other flammable materials contact heating elements, areas near elements or interior surfaces of oven until they have had sufficient time to cool. Other areas may become hot. Among these areas are the cooktop, the surfaces facing the cooktop, the oven vent opening and the surfaces near opening, oven door, and oven window.

About Your Appliance

To prevent injury or damage to the appliance, do not use appliance as a space heater to heat or warm a room. Also, do not use the cooktop or oven as a storage area for food or cooking utensils.

Keep the oven vent ducts **UNOBSTRUCTED** (located under the right rear element for coil cooktops or on the cooktop for smoothtop models). Blockage of the vent prevents the proper oven air circulation and will affect the oven performance.

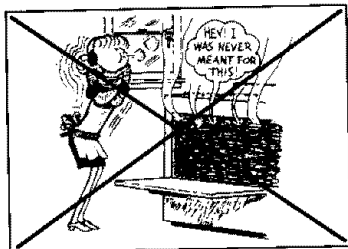

CAUTION: Do not use an appliance as a step stool to cabinets above. Misuse of appliance doors or drawers, such as stepping, leaning or sitting on the door or drawer, may result in possible tipping of the appliance, breakage of door, and serious injuries.

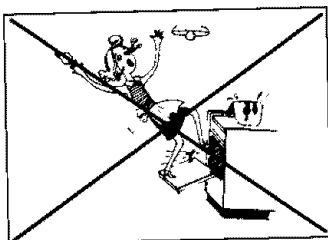

Do not touch a hot oven light bulb with a damp cloth as the bulb could break. Should the bulb break, disconnect power to the appliance before removing bulb to avoid electrical shock.

Cooking Safety

Always turn off surface element or the oven when cooking is completed.

It is normal for some parts of the cooktop, especially areas surrounding the surface elements, to become hot during cooking operations. Do not touch the cooktop until it has cooled.

Never leave surface cooking operations unattended at high heat setting or when deep fat frying. Boilovers cause smoke and greasy spillovers may ignite.

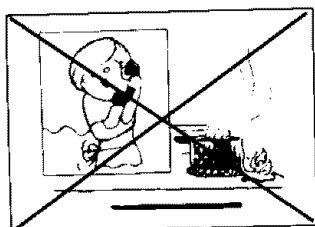

Do not allow aluminum foil or any other metal object (other than a pan on a surface element) to contact heating elements.

Utensil Safety

Use proper pan size. This appliance is equipped with one or more surface elements of different sizes. Select utensils having flat bottoms large enough to cover the surface element. The use of undersized utensils will expose a portion of the heating element to direct contact and may result in the ignition of clothing. The proper relationship of the utensil to the element will also improve efficiency.

Use pans with flat bottoms and handles that are easily grasped and stay cool. Avoid using unstable or loose handled pans.

Be sure utensil is large enough to properly contain food and avoid boilovers. Pan size is particularly important in deep fat frying.

To minimize burns, ignition of flammable materials and spillage due to unintentional contact with the utensil, do not extend handles over adjacent surface elements. Always turn pan handles toward the side or back of the appliance, not out into the room where they are easily hit or reached by small children.

Never let a pan boil dry as this could damage the utensil and the appliance.

Follow the manufacturer's directions when using oven cooking bags.

Only certain types of glass, glass/ceramic, ceramic, or glazed utensils are suitable for cooktop or oven usage without breaking due to the sudden change in temperature.

This appliance has been tested for safe performance using conventional cookware. Do not use any devices or accessories that are not specifically recommended in this manual. Do not use eyelid covers for the surface units, stove top grills, or add-on oven convection systems. The use of devices or accessories that are not expressly recommended in this manual can create serious safety hazards, result in performance problems, and reduce the life of the components of the appliance.

Cleaning Safety

Clean only parts listed in this book and follow recommended procedures.

Turn off all controls and wait for appliance parts to cool before touching or cleaning them.

Clean cooktop with caution. Use care to avoid steam burns if a wet sponge or cloth is used to wipe spills on a hot surface. Some cleaners can produce noxious fumes if applied to a hot surface.

Do not soak or immerse the removable heating elements in water (select models). Immersing an element in water would damage the insulating material inside the element.

Do not use aluminum foil to line the surface unit drip bowls (select models) or the oven bottom. Improper installation of these liners may result in a risk of electric shock or fire.

Self-Clean Oven

Do not clean door gasket. The door gasket is essential for a good seal. Care should be taken not to rub, damage, or move the gasket. Do not use oven cleaners of any kind in or around any part of the self-clean oven.

Before self-cleaning the oven, remove broiler pan, oven racks, and other utensils, and wipe off excessive spillovers to prevent excessive smoke or flare-ups. **CAUTION: DO NOT LEAVE FOOD OR COOKING UTENSILS, ETC., IN THE OVEN DURING THE SELF-CLEAN CYCLE.**

It is normal for the cooktop of the range to become hot during a self-clean cycle. Therefore, touching the cooktop during a clean cycle should be avoided.

A fan should be heard during the self-clean cycle. If not, cancel the cycle and call servicer. Refer to the Table of Contents for location of self-clean instructions and for information, if equipped.

Important Safety Notice and Warning

The California Safe Drinking Water and Toxic Enforcement Act of 1986 (Proposition 65) requires the Governor of California to publish a list of substances known to the State of California to cause cancer or reproductive harm, and requires businesses to warn customers of potential exposures to such substances.

Users of this appliance are hereby warned that when the oven is engaged in the self-clean cycle (select models), there may be some low level exposure to some of the listed substances, including carbon monoxide. Exposure to these substances can be minimized by properly venting the range to the outdoors during the self-clean cycle by opening the windows and/or door in the room where the appliance is located.

SAVE THESE INSTRUCTIONS

RANGE CONTROL PANEL

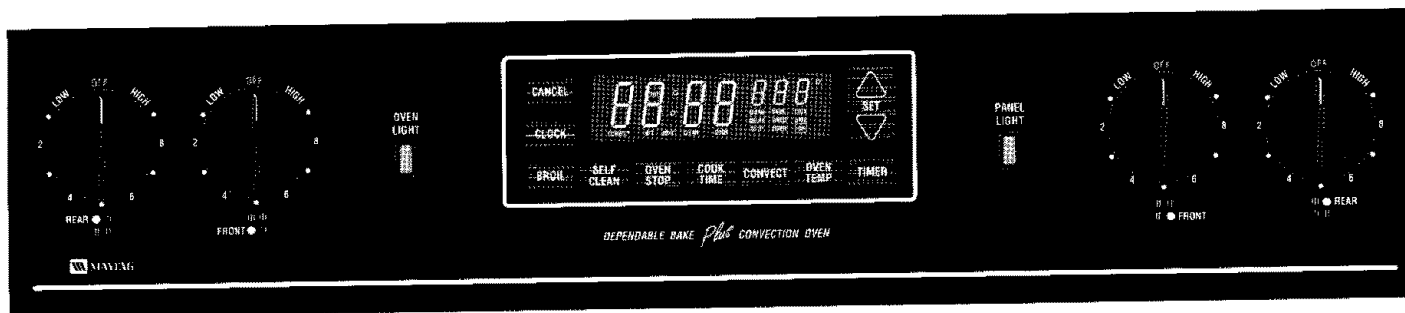

Styling may differ depending on the model you selected.

Electronic Clock and Oven Control



The electronic clock and oven control on your Maytag range is used for the time-of-day clock, timer, bake, convection bake, broil, programmed oven operations and self-clean functions. A beep will sound each time a function pad is pressed.

The display on the control will flash when power is first supplied to the range or if there is a power failure. Once the time-of-day clock has been set (see Setting the Clock, page 6), the display will stop flashing.

The oven will automatically turn off if it is left on for 12 hours.

NOTE: The electronic control is equipped with a self-diagnostic feature for service use **ONLY**. If a fault code (F plus a number, example F1) appears in the display along with a continuous beeping sound, press the CANCEL pad. See Before You Call for Service (page 20) if the fault code reappears in the display.

The following pads are found on your Maytag electronic clock and oven control:

Cancel Pad

Press this pad to cancel all operations except the time-of-day clock and timer. If you are ever unsure if you've programmed the control correctly, press the CANCEL pad and start over.

Clock Pad

Use this pad to set the time-of-day clock. See page 6 for instructions on setting the clock.

You may also press this pad to recall the current time of day. For example, if the timer is counting down in the display, press the CLOCK pad to return the current time to the display. The timer will continue to count down and a signal will sound when the time expires.

Broil Pad

Use this pad to select broil. Two heat selections are available for broiling—Hi and Lo. See page 12 for more broiling information.

Self Clean Pad

Press this pad to set the oven for a self-clean cycle. See pages 14–15 for detailed information on the self-clean feature.

Oven Stop/Cook Time Pads

These pads are used to program the oven to start and stop automatically, either immediately or at a later time. For detailed information on using Programmed Oven Operations, see pages 12–13.

Convect Pad

Press this pad to select convection baking and roasting. Set the oven temperature by pressing the ▲ or ▼ pads. See pages 10–11 for more information on convection cooking.

Oven Temp Pad

Press this pad to select regular baking and roasting. Set the oven temperature by pressing the ▲ or ▼ pads. Additional information can be found on pages 10–11.

Timer Pad

The timer can be set from 1 minute to 9 hours, 50 minutes. It will count down by seconds (when set for 1 minute) or minutes (when set for 2 minutes or more time). See below for instructions on setting the timer.

▲ and ▼ Pads

Press or press and hold these pads to enter the time or temperature desired. These pads are also used to select Hi or Lo broil.

Setting the Clock and Timer

Clock

To set the time-of-day clock:

1. Press the CLOCK pad once. The words “SET TIME” will flash in the display.
2. Set the correct time of day using the ▲ and ▼ pads.
 - To change the time by one minute, press either pad **once**.
 - To change the time in increments of 10 minutes, **press and hold** either pad.

When the power is first supplied to the range or if there has been a power failure, the display will flash. Follow above instructions to set the clock. The clock time cannot be changed when the oven is set for a time cook or self-clean operation. Cancel the operation to set the clock.

Press the CLOCK pad to recall the time of day when another function is displayed.

Timer

To set the timer:

1. Press the TIMER pad once. The words “SET TIMER” will flash in the display.
2. Set the desired time using the ▲ and ▼ pads.
 - Press either pad **once** to change the time by 1 minute (if the Timer is set for up to 1 hour), 5 minutes (if Timer is set for over 1 hour) or 10 minutes (if the Timer is set for over 2 hours).
 - **Press and hold** either pad to change the time in 5 minute or 10 minute increments, depending upon the time set in the display.

The TIMER can be set from 1 minute (0HR:01) up to 9 hours and 50 minutes (9 HR:50).

The timing operation will start automatically. Colons will flash in the display to indicate a timing operation. One long continuous beep will signal the end of the timing operation and “End” will briefly appear in the display. The time of day will automatically reappear in the display. **The TIMER pad does not control the oven.**

To cancel: Press the TIMER pad and hold for 3 seconds. The time of day will reappear after a slight delay.

SURFACE COOKING

Panel Light (select models)

The panel light is turned on by pushing the rocker switch on the control panel and holding it in until the fluorescent light comes on. It may be turned off by pushing the other side of the switch.

The Controls

Your range is equipped with surface control knobs that provide an infinite choice of heat settings from **Low** to **High**. The knobs can be set on or between any of the numbered settings.

To operate the control: Push in and turn the knob in either direction to the desired heat setting. A surface indicator light on the control panel will turn on to alert you that one or more of the surface elements are on. After a cooking operation, be sure the elements and indicator lights are off.

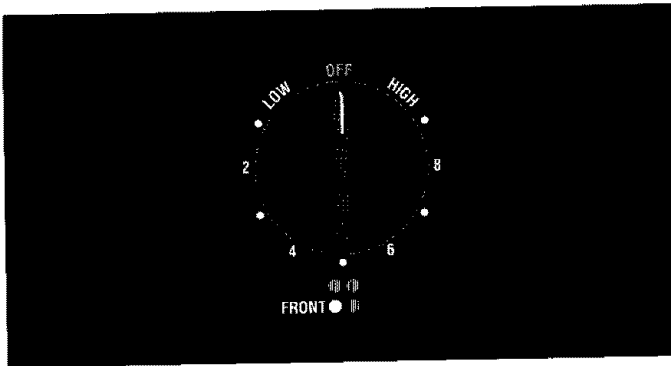

Suggested Heat Settings

Turn the control knob to the desired heat setting. If in doubt, it is better to select a lower setting and increase to a higher one later if needed. It will take longer for the element to cool to a lower temperature than to heat up to a higher temperature.

Use the following chart as a guideline until you become more familiar with your new range. Information in the chart is based on the use of heavy gauge metal cookware. Other pan materials may require a different heat setting for the same cooking operation. (For more information on cookware, see “Cooking Made Simple” booklet.)

| Setting | Uses |
|-------------|---|
| HIGH | To bring liquid to a boil, blanch or bring up pressure in a pressure cooker. Always reduce to a lower heat setting when liquids just begin to boil or food begins to cook. |
| 8-9 | To quickly brown or sear meat, for fast cooking of non-protein foods (such as vegetables or pasta). |
| 7 | To maintain a fast boil for large amounts of liquid. |
| 5-6 | To maintain a slow boil for large amounts of liquid, for most frying. |
| 3-4 | To continue cooking uncovered foods, for most slow frying, stewing, braising or steaming. |
| 1-2 | For long, slow cooking of covered foods (simmering). |
| LOW | To keep foods warm before serving, melt chocolate or butter. |

Using Your Ceramic Glass Surface (select models)

On Canadian models, the cooking areas will not operate during a self-clean cycle. This is normal.

Cooking Areas

The cooking areas on your range are identified by permanent patterns in the ceramic glass surface. There are two large (8-inch) and two small (6-inch) areas. For most efficient cooking, use smaller areas for small pans and larger areas for large pans. **For best results pans should not extend more than 1/2 to 1 inch beyond the cooking area.**

When a cooking area is turned on, a red glow from the element can be seen through the ceramic glass surface. The red glow will cycle on and off as the element cycles to maintain the selected heat setting.

Hot Surface Light

Your ceramic glass range is equipped with a red **Hot Surface** Light that will turn on to indicate that the cooking surface is hot. It will remain on until the area has cooled.

Heat Retention

The ceramic glass cooking area retains heat for a period of time after the elements have been turned off. Put this retained heat to good use. Turn the elements off a few minutes before food is completely cooked and use the retained heat to complete the cooking. Because of this heat retention characteristic, the elements will not respond to changes in heat settings as quickly as coil elements. **In the event of a potential boilover, remove the pan from the cooking area.**

NOTE: During the first few hours of use, you may notice that the ceramic cooktop emits a slight burning odor and a light smoke. Both of these conditions are normal and are caused by the insulation material of the heating elements in a new ceramic cooktop.

Tips to Protect the Ceramic Glass Cooktop

- **BEFORE FIRST USE, CLEAN COOKTOP** as directed in the cleaning chart, pages 16–17.
- Do not use glass pans on the ceramic glass cooktop. Glass ceramic, earthenware, heatproof glass or glazed pans may scratch the cooktop and are not recommended.
- Do not allow plastic, aluminum foil, sugar, or foods with high sugar content to melt onto the hot cooktop. If you accidentally melt these items to the cooktop, remove immediately while still hot using a razor blade scraper held carefully with a potholder. Melted materials can cause permanent damage to the cooktop. Do not attempt further cleaning until the area has cooled.
- To protect the ceramic glass top, it is not recommended to use the top as a work surface, as a cutting board or to cook food directly on the cooktop without a pan.
- Do not use a trivet or metal stand (such as a wok ring) between the pan and the cooktop. These items can mark or etch the surface and affect cooking efficiency.
- Aluminum foil or foil containers such as popcorn poppers are **NOT** recommended for use on the ceramic glass cooktop. They will leave metal marks and may permanently melt onto the ceramic glass top if the cooking area is turned on.
- Do not slide metal or glass items across the ceramic glass cooktop. They may damage the top or leave marks which need to be removed promptly (see cleaning chart pages 16–17).
- Do not allow pan to boil dry as this could damage the cooktop and the pan.
- To prevent scratching or damage to the ceramic glass top do not leave sugar, salt, sand, soil, shortening or other fats on the cooking area. Be sure the area is free from these before turning on the cooking area. Make it a practice to wipe cooktop surface with a clean damp cloth or paper towel before each use.

CAUTION: If metal melts onto the ceramic surface, do not use top. **Call an authorized servicer.** Do not attempt to repair cooktop yourself.

Using Your Coil Element Cooking Surface (select models)

It is normal for some parts of the cooktop, especially areas surrounding the surface elements, to become warm or hot during surface cooking operations. Therefore, do not touch or let heat-sensitive materials such as plastics touch the cooktop until it has had time to cool.

Lift-up Cooktop

Your range features an upswept cooktop that can be lifted up for convenient access to the area under the cooktop. The top is hinged and can be raised but not removed.

To lift cooktop: When cool, grasp the front edge of the cooktop and gently lift up until the two automatic prop rods at the front of the cooktop snap into place.

To lower cooktop: Hold the front edge of the cooktop and carefully push back on each prop rod to release the notched support. Then gently lower the top into place. The prop rods will slide into the range frame.

Coil Elements

The coil elements of your range are self-cleaning. Do not immerse the elements in water.

To remove: Raise the element when cool and carefully pull out and away from the receptacle.

To replace: Insert the terminals on the element into the receptacle and guide the element into place until it sits level on the drip bowl.

Drip Bowls

The drip bowls, located under each surface element, are designed to catch boilovers. They must always be used—absence of these bowls during cooking may damage wiring or other parts underneath the cooktop.

Clean the drip bowls frequently. See cleaning section, page 14.

Drip bowls will discolor or craze over time or if overheated. This discoloration or crazing is permanent. However, it will not affect cooking performance.

USING YOUR OVEN

Your oven combines the best of two cooking methods, convection and regular (radiant).

You can enjoy the many benefits of convection cooking, plus a fully featured regular oven. This gives you the flexibility of preparing various foods when convection cooking may not be as beneficial.

For baking, convection and roasting tips, refer to “Cooking Made Simple” booklet.

Every oven has its own characteristics. You may find that the cooking times and temperatures vary slightly from your old oven. This is normal.

For safety reasons, when opening the oven door, allow steam and hot air to escape before reaching into the oven to remove food.

Baking and Roasting

Setting the Oven Controls for Baking, Convection Baking, Roasting and Convection Roasting

1. Place racks on proper rack positions.
2. Press the OVEN TEMP or the CONVECT pad. “BAKE” or “CONVECT BAKE” and 000° will appear in the display.
3. Press either the ▲ or ▼ pad once and 350° will appear in the display when in the bake mode. When in the convect mode 325° will appear. Press the ▲ or ▼ pad until the desired oven temperature is displayed.

The word ON will light in the display, the oven will turn on and the temperature display will rise in 5° increments while the oven is preheating. A beep will sound to indicate that the oven has preheated. Allow 10–15 minutes for preheating.

4. After the cooking operation, turn the oven off by pressing the CANCEL pad. Remove food from the oven.

NOTE: To change the oven temperature during a baking operation, press the ▲ or ▼ pad until the desired temperature is displayed.

NOTE: If the oven temperature is not selected within 30 seconds, the program will automatically cancel.

IMPORTANT: Do not move the door lock lever to the right during baking or roasting. The oven door may lock and will not unlock until the oven cools.

Oven Racks

The four oven racks are designed with a lock-stop edge to keep the racks from coming completely out of the oven when there is food placed on them.

To remove: Be sure the rack is cool. Pull the rack straight out until it stops. Tilt the front end of the rack up and continue pulling it out.

To replace: Tilt the front end of the rack up and place it between the rack supports. Slide it back until it clears the lock-stop position. Lower the front and slide the rack straight in.

Do not cover an entire oven rack or oven bottom with aluminum foil. This will restrict air flow.

Rack Positions

Do not attempt to change the rack positions when the oven is hot. Use the following guidelines when selecting the proper rack position. **Never place pans directly on the oven bottom.**

Regular Baking and Roasting Positions

| | |
|--------------------------------------|---|
| Rack 1: (lowest position) | Used for roasting large cuts of meat and large poultry, frozen pies, souffles or angel food cake. |
| Rack 2: | Used for roasting small cuts of meat, large casseroles, baking loaves of bread, cakes (in either tube, bundt or layer pans) or two-rack baking. |
| Rack 3: (middle position) | Used for most baked goods on a cookie sheet or jelly roll pan, or frozen convenience foods. |
| Rack 4: | Used for most broiling and two-rack baking. |
| Rack 5: (highest position) | Used for broiling thin, non-fatty foods such as fish, toasting bread. |

Convection Baking and Roasting Positions

Because heated air is circulated evenly throughout the oven, foods can be baked with good results on 2, 3 and 4 racks at a time. Multi-rack baking may increase cook times slightly for some foods, but the overall result is time saved.

- When using three racks during convection baking, place the racks in positions 1, 3 and 5 (refer to diagram 1).
- When using four racks during convection baking, place the racks in positions 2, 3, 4 and 5 (refer to diagram 2).

NOTE: Food in the lowest rack position may need to be removed 1-2 minutes before the set time to prevent overbrowning.

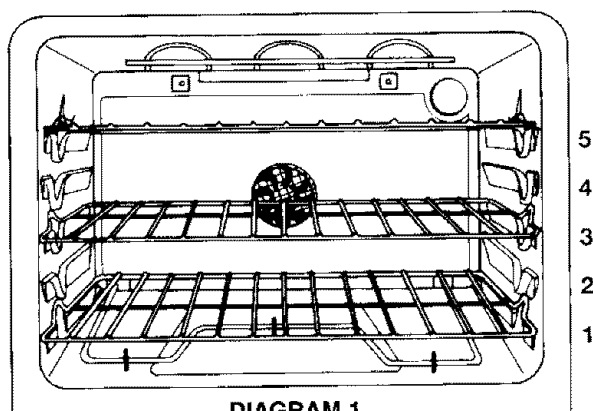

DIAGRAM 1

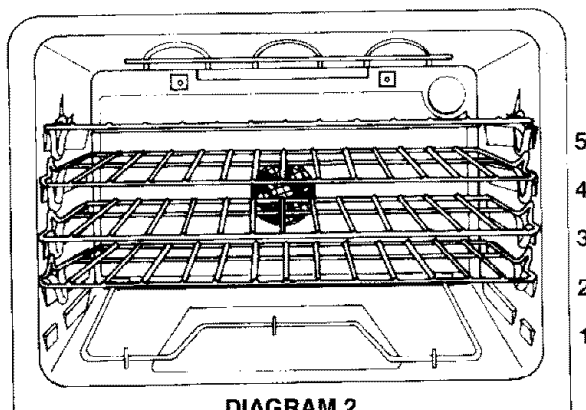

DIAGRAM 2

Oven Light

Push the switch on the control panel marked OVEN LIGHT to turn it on and off. On select models the oven light automatically comes on whenever the oven door is opened.

Oven Vent

The oven vent is located on the cooktop or under the right rear element on ranges with coil elements. When the oven is in use, this area may feel warm or hot to the touch. To prevent problems, do not block the vent opening.

Fan(s)

Your range is equipped with a convection fan. (Slide-in models also have a cooling fan.)

The convection fan is used to circulate hot air in the oven. It automatically turns on after five minutes whenever the CONVECT pad is pressed and will turn off when CONVECT is cancelled.

THE CONVECTION FAN WILL AUTOMATICALLY STOP WHENEVER THE OVEN DOOR IS OPENED.

Slide-in ranges (select models) are also equipped with a fan that is used to help keep the clock and oven controls cool to ensure long life. This fan will automatically turn on whenever the oven is set for a cooking or a self-clean operation. It will automatically turn off when parts have cooled. The fan may continue to operate after the oven has been turned off. This is normal.

Broiling

For best results, use the broiler pan and insert supplied with your range.

(For additional broiling tips, refer to “Cooking Made Simple” booklet.)

Setting the Controls for Broiling:

1. Press the BROIL pad and press the ▲ or ▼ pad to select either Hi or Lo broil as indicated in the display. Hi is used for most broiling operations. Lo should be selected when broiling thicker meats to the well-done stage (to prevent excessive browning). Broiling times may increase if Lo is selected. **Allow the element to preheat for 3–4 minutes.**
2. Place the broiler pan on the recommended rack position shown in the broiling chart.
3. Follow the suggested times in the broiling chart below. Broil with the oven door open about 4 inches.
4. Check the doneness by cutting a slit in the meat near the center to check the color.
5. To cancel or end the broiling operation, press the CANCEL pad.
6. Broil times may need to be increased if the range is installed on a 208 volt circuit.

Broiling Chart

Until you become more familiar with your new range, use the following chart as a guide when broiling foods.

| Food | Quantity &/Or Thickness | Temp. | Rack Position* | Doneness | Approx. Minutes/Side | |
|------------------------|-------------------------|-------|----------------|----------|----------------------|----------|
| | | | | | 1st Side | 2nd Side |
| Bacon | | Hi | 4 | well | 4–5 | 2–4 |
| Beef Patties | ¾-inch thick | Hi | 4 | well | 8–10 | 7–8 |
| Steaks | 1-inch thick | Hi | 4 | medium | 8–10 | 7–8 |
| | | | 4 | well | 10–13 | 9–10 |
| Chicken Pieces | | Lo | 3 | well | 16–25 | 14–20 |
| Fish | ½-inch thick | Hi | 4 | flaky | 4–5 | 4–6 |
| | 1-inch thick | Hi | 4 | flaky | 7–9 | 4–6 |
| Ham Slices (precooked) | ½-inch thick | Hi | 4 | heated | 5–7 | 4–6 |
| Pork Chops | 1-inch thick | Hi | 3 | well | 12–14 | 10–12 |

*The bottom rack position is #1.

Programmed Oven Operations

The Programmed Oven Operations feature is used to turn the oven off at a preset time of day or delay the start and then turn off the oven.

This feature will not operate unless the clock is functioning and is set to the correct time of day.

If you delay more than 30 seconds between touching a pad and pressing the ▲ or ▼ pad, the display will either return to the previous setting or the time of day will reappear and the program will cancel.

To recall the preset stop time or cook time, just press the corresponding pad.

To reset or cancel the program, press the CANCEL pad.

IMPORTANT: Highly perishable foods such as dairy products, pork, poultry, seafood or stuffing are not recommended for delayed cooking. If cooking more than one food, select foods that cook for the same length of time and at the same oven temperature.

To Bake by Time (with immediate start):

1. Place the food in the oven.
2. Press the COOK TIME pad. The words "SET COOK TIME" will flash in the display.
3. Enter the cooking time (how long you wish the food to cook) by pressing the ▲ or ▼ pad. The time will appear in hours and minutes. The maximum time that can be set is 11 hours and 55 minutes.
4. Press the OVEN TEMP pad. The word "BAKE" and 000° will light in the display. If this step is not done within 7 seconds after entering the cook time, the control will beep until another pad is pressed.
5. Enter the oven temperature with the ▲ or ▼ pad.
6. The oven will automatically turn on and the words "TIMED BAKE ON" will light in the display. The display will begin to count down the time remaining.
7. **At the end of the preset cooking time, the oven will automatically turn off and continuous beeps will sound.** Remove the food from the oven and press the CANCEL pad to stop the beeps.

Example for Immediate Start:

Food is to cook for 1½ hours at 350°F.

1. Press the COOK TIME pad.
2. Press the ▲ pad until 1:30 (1 hour, 30 minutes) appears in the display.
3. Press the OVEN TEMP pad.
4. Press the ▲ pad until 350° appears in the display. The oven will turn on immediately.



To Bake by Time (with delayed start):

1. Place the food in the oven.
2. Press the COOK TIME pad. The words "SET COOK TIME" will flash in the display.

3. Enter the cooking time (how long you wish the food to cook) by pressing the ▲ or ▼ pad. The time will appear in hours and minutes. The maximum time that can be set is 11 hours and 55 minutes. **NOTE:** The oven automatically programs the start time.
4. Press the OVEN STOP pad. The words "SET STOP TIME" will flash in the display.
5. Enter the time you wish the oven to turn off by pressing the ▲ or ▼ pad. The words "DELAY STOP TIME" will light in the display.
6. Press the OVEN TEMP pad. The words "DELAY BAKE" and 000° will light in the display.
7. Enter the oven temperature by pressing the ▲ or ▼ pad.
8. If desired, press the CLOCK pad and the time of day will reappear in the display.
9. At the preset time the oven will automatically turn on and "TIMED BAKE" will appear in the display.
10. **At the end of the preset cooking time, the oven will automatically turn off and continuous beeps will sound.** Remove the food from the oven and press the CANCEL pad to stop the beeps.

Example for Delay Start:

Food is to cook for 2½ hours at 350°F. You wish the food to be cooked by 6:00.

1. Press the COOK TIME pad.
2. Press the ▲ pad until 2:30 (2 hours, 30 minutes) appears in the display.
3. Press the OVEN STOP pad.
4. Press the ▲ pad until 6:00 appears in the display.
5. Press the OVEN TEMP pad.
6. Press the ▲ pad until 350° appears in the display.

The oven will turn on at 3:30, cook the food for 2½ hours and will automatically turn off at 6:00. Press the CANCEL pad to stop the beeps.



CARE AND CLEANING

WARNING: Before cleaning, be certain all the elements are turned off and the range is cool.

Ceramic Glass Surface (select models)

To help keep cooktop clean, be sure cooking area and cookware bottoms are clean and dry before each use.

Carefully blot up spillovers around the outside of the cooking area as they occur with dry paper towels. **Be careful not to burn hands when wiping up spills. Do not use a damp cloth which may cause steam burns.**

When the surface is cool, clean as directed in the cleaning chart on pages 16–17. Only use the cleaning agents recommended in the chart. Other materials may damage the finish of the cooktop.

Do not use the following cleaning agents:

- Abrasives (metal scouring pads, cleansing powders, scouring cleaners or pads) will scratch the cooktop.
- Chemicals (oven cleaners, chlorine bleaches, rust removers or ammonia) may damage the finish of the cooktop.
- Glass cleaners which contain ammonia may harm the cooktop.
- Soiled cloths or sponges will leave an invisible film on the cooktop. Grit and soil in these items may also scratch the surface.

Coil Element Surface (select models)

Porcelain Drip Bowls

Clean bowls frequently. Remove soiled bowls by first removing the coil elements (see page 9). To clean by hand, soak in hot, sudsy water. Use a mild abrasive cleaner or soap-filled scouring pad for hard to remove soil.

Bowls may also be washed in an automatic dishwasher or placed on newspapers and sprayed with commercial oven cleaner. For heavy soils, spray with oven cleaner and place in plastic bag overnight. Follow the manufacturer's instructions. **CAUTION:** When using oven cleaner, spray carefully. Spraying other areas could damage finishes.

Porcelain Enamel Cooktop

All spillovers, especially acidic spillovers, should be wiped up as soon as possible with a dry cloth. To prevent possible cracking or chipping of the porcelain, never wipe a warm or hot surface with a damp cloth.

Do not use abrasive or caustic cleaning agents on the porcelain finish. Abrasive cleaners will permanently damage the finish.

Self-Clean Oven

A self-clean oven uses above normal cooking temperatures to automatically clean the entire oven. The separate clean cycle eliminates soil completely or reduces it to a gray ash which is easily wiped up with a damp cloth when the cycle is complete and the oven has cooled.

It is better to clean the oven regularly than to wait until there is a heavy build-up of soil in the oven.

It is normal for the cooktop, oven door and window to become hot during a clean cycle. Therefore, avoid touching these areas during a clean cycle. As the oven heats and cools, you may hear the sounds of metal parts expanding and contracting. This is normal and will not damage your oven.

The first few times the oven is cleaned, some smoke and odor may be detected. This is normal and will lessen or disappear with use. If the oven is heavily soiled, smoke and odor are common. During the cleaning process the kitchen should be well ventilated.

The oven will automatically begin to heat when the door is locked and the SELF CLEAN pad is pressed. **When the oven reaches cleaning temperature, the word "LOCK" will light in the display. At this point, the oven door cannot be manually opened.**

To prevent damage to the door and lock lever, do not force the door open when the word "LOCK" is displayed.

DO NOT USE COMMERCIAL OVEN CLEANERS IN THE SELF-CLEAN OVEN.

Preparing for the Self-Clean Cycle

1. Remove oven racks and any pans, utensils or the broiler pan from the oven. The oven racks should be washed by hand. **If left in the oven during the self-clean cycle, the racks will become permanently discolored and may not slide easily.**
2. Clean the oven frame and door frame with a non-abrasive cleaning agent such as Bon Ami. These areas are not exposed to cleaning temperatures and should be cleaned to prevent soil from baking on during the clean cycle.
3. Wipe up any excess grease or spillovers from the oven bottom to prevent excessive smoking and flare-ups during the clean cycle.
4. Wipe up acid spillovers such as lemon juice, tomato sauce or milk-based sauces and sugary spillovers. Porcelain enamel is acid resistant, not acid proof. **The porcelain finish may discolor if acid spills are not wiped up prior to a self-clean cycle.**
5. **Do not use oven cleaners or oven liner protective coatings of any kind on the self-clean oven finish or around any part of the oven as they will damage the oven finish.**
6. To prevent damage, do not clean or rub the gasket on the oven door. The gasket is designed to seal in heat during the clean cycle.
7. Turn off the oven light before starting the self-clean operation. If the oven light is left on during the clean cycle, the light bulb will burn out.

Setting the Controls for the Self-Clean Cycle

1. Close the oven door and move the door lock lever to the right until it rests in the lock position.
2. Press the SELF CLEAN pad. The words "SET CLEAN TIME" will flash and "3:00" will appear in the display. Also, "CLEAN ON" will light as the oven begins to heat.

The oven will automatically set a clean cycle of three hours. A shorter (2 hours) or longer (4 hours) clean cycle can be selected by pressing the SELF CLEAN pad and pressing the ▲ or ▼ pad to select 2 to 4 hours.

3. Press the CLOCK pad and the current time of day will reappear in the display. "CLEAN" and "ON" will remain in the display to show that the oven is in a clean cycle.

If the door is not locked properly, the word "door" will appear in the display and beeps will sound.

To Interrupt or Reset the Clean Cycle

If the internal lock has not engaged, the lock lever can be moved completely to the left to cancel the cycle.

If the internal lock has engaged, push the CANCEL pad. The door will not open until "LOCK" turns off in the display. At that time, the door lock lever can be returned to its original position and the door can be opened. The oven will still be hot.

After the Self-Clean Cycle

About one hour after the clean cycle is complete, the word "LOCK" will turn off in the display and the door lever can be returned to its original position. The oven will still be hot.

Some soil may leave a light gray, powdery ash which can be removed with a damp cloth. If soil remains, it indicates that the clean cycle was not long enough or a large spillover was not wiped up before the self-clean cycle. The soil should be removed during the next clean cycle.

If the oven racks were left in the oven during the self-clean cycle and do not slide smoothly, wipe the rack edges and rack supports with a small amount of vegetable oil to restore the ease of movement.

Fine hair-like lines may appear in the oven interior or oven door. This is a normal condition resulting from the heating and cooling of the porcelain finish. These lines do not affect the performance of the oven.

For more information on cleaning your Maytag range, refer to the following cleaning chart, pages 16-17.

RANGE CLEANING CHART

Cleaning Agents*

Many different cleaning agents are recommended for the various parts of the range. **Read product labels for specific recommendations.** The following brand names may help you to make an appropriate selection:

1. Mild abrasive cleaners such as Bon Ami, Soft Scrub, Smart Scrub, Baking Soda.
2. Mild liquid sprays such as Fantastik and Formula 409.
3. Glass cleaners such as Windex and Glass Plus.
4. Non-abrasive plastic mesh and nylon scouring pads such as Tuffly.

DO NOT USE abrasive cleansing powders such as Comet, soap-filled scouring pads like S.O.S. or Brillo, commercial oven cleaners, or an automatic dishwasher **except when indicated.**

Be certain all range parts are cool before removing any part or cleaning the unit to avoid damage. Any parts that are removed for cleaning should be replaced correctly.

*Brand names of cleaning agents are trademarks of the respective manufacturers.

| Parts | Cleaning Agents | Tips and Precautions |
|---|--|--|
| Baked Enamel: Side Panels Storage Drawer Subtop (select models) | Soap and water Mild liquid cleaner Glass cleaner | Wash, rinse, dry with soft cloth. Do not use oven cleaner or abrasive agents. |
| Broiler Pan and Insert | Soap and water Plastic or soap-filled scouring pad Dishwasher | Soaking makes cleaning easier. |
| Ceramic Glass (Ceran®) Cooktop (select models) Light to moderate soil | Cooktop Cleaning Creme or other products specially formulated for ceramic glass Soap and water Baking soda and water paste | Wait until cooktop has cooled before cleaning. Gently apply cleaning agent with a non-abrasive pad, paper towel or clean cloth. If using soap or baking soda, rinse thoroughly and completely dry. Do not use a soiled dishcloth or sponge since these may leave a detergent film and discoloration. |
| Heavy soil or brown/gray stains from hard water or metal marks | Cooktop Cleaning Creme or other products specially formulated for ceramic glass | Gently scrub with cleaning creme and clean cloth or paper towel. Reapply cleaner. Cover with damp paper towels to keep cleaner moist. Let stand for 30-45 mins. Scrub to remove remaining stain. Do not use abrasive powders or pads since they may scratch the surface. |
| Burned-on or crusty soils or residue | Single-edge razor blade Cooktop Cleaning Creme or other products specially formulated for ceramic glass | Hold razor blade scraper at 30° angle and very carefully scrape off soil. Clean remaining soil with cleaning creme. |
| Sugar, plastic, aluminum foil | Single-edge razor blade held with a potholder or a wooden handled stainless steel spatula | Scrape from hot surface to a cool area immediately. Clean residue with cleaning creme when surface has cooled. |
| Control Knobs | Soap and water Mild liquid sprays Glass cleaners | Remove knobs by pulling forward. Wash, rinse, dry with soft cloth. Do not soak knobs in water. Do not use abrasive cleaning agents. |

Continued on next page

Range Cleaning Chart (continued)

| Parts | Cleaning Agents | Tips and Precautions |
|--|---|--|
| Glass Oven Window/Door | Soap and water Glass cleaners | Avoid using excessive amounts of water which may seep under or behind glass. |
| Metal Finishes and Trim Door Handle | Soap and water Mild abrasive cleaners | Do not use oven cleaner or abrasive agents. Polish with a soft cloth. |
| Oven Racks | Soap and water Plastic scouring pads Cleansing powders Soap-filled scouring pads | If racks are left in oven during a self-clean cycle they will discolor and may become difficult to slide. A thin coat of vegetable oil on the oven rack edges will make sliding easier. |
| Plastic Finishes: Back Panel End Caps | Soap and water Mild liquid sprays | Do not use oven cleaner, abrasive or caustic cleaning agents on plastic finishes. These cleaning agents will scratch or mar the finish. To prevent staining or discoloration, remove fat, grease or acid (tomato, lemon, vinegar, milk, fruit juice, marinade) soils immediately with a dry paper towel or cloth. When surface is cool, clean with soap and water; rinse and dry. |
| Porcelain Drip Bowls (select models) | Soap and water Mild abrasive cleaners Soap-filled scouring pads Dishwasher Commercial oven cleaners | DO NOT COVER WITH ALUMINUM FOIL. Frequently wash, rinse and dry to prevent soil build-up. Soak in hot, sudsy water. Use mild abrasive cleaners and soap-filled scouring pads, if necessary. For difficult soils, remove, place on newspapers and spray carefully with commercial oven cleaner. Place in plastic bag overnight for heavy soils. Follow manufacturer's instructions. Discoloration or crazing may occur over time or if overheated. This is normal and does not affect performance. |
| Porcelain Enamel Cooktop (select models) | Soap and water Mild abrasive cleaners Mild liquid sprays | Wipe up all spillovers immediately with a dry cloth—especially acid spills (milk, tomato, etc.). Never wipe a warm or hot surface with a damp cloth as cracking and chipping may result. NOTE: Do not use abrasive cleaning agents such as steel wool pads. These products will scratch the surface. |
| Self-Clean Oven Interior | Follow instructions on pages 14–15 for the self-clean cycle. | Never use oven cleaner on a self-clean oven. Do not clean or rub door gasket. Wipe up acid spills (tomato or milk based foods) as soon as oven is cool with soap and water. If the spill is not wiped up, it may discolor the porcelain. |



MAINTENANCE

Adjusting the Oven Thermostat

After using your oven the first few times, it may seem hotter or cooler than your previous oven. Oven thermostats, over a period of years, may drift from the factory setting and timing differences of 5 to 10 minutes are not unusual between an old and a new oven.

If you think the oven should be hotter or cooler, you can adjust it. To decide how much to change the thermostat, set the oven temperature 25°F higher or lower than the temperature in your recipe, then bake. The results of the "test" should indicate how much the thermostat should be adjusted.

To adjust the thermostat:

1. Press the OVEN TEMP pad.
2. Press the ▲ pad and select an oven temperature between 500°F and 550°F.
3. Press and hold the OVEN TEMP pad for about four seconds. The display will change to the oven adjustment display which reads 00°.
4. The oven thermostat can be adjusted up to +35°F hotter or -35°F cooler. Use the ▲ or ▼ pad to select the desired change in the display.
5. When you have made the adjustment, press the CANCEL pad to return to the time of day display. Use your oven as you would normally.

NOTE: This adjustment will not affect Broil or Self-Clean temperatures. The new temperature will be remembered if the power is interrupted.

Storage Drawer

The storage drawer in the range is a safe and convenient place for storing cookware. **Do not** store plastic, paperware, food or flammable material in this drawer. Remove the drawer to clean under the range.

To remove: Empty the drawer then pull it out to the first stop position. Lift up the front of the drawer and pull it to the second stop position. Grasp the sides and lift up and out to remove the drawer.

To replace: Fit the ends of the drawer glides onto the rails. Lift up the drawer front and gently push in to the first stop position. Lift up the drawer again and continue to slide the drawer to the closed position.

Leveling Legs

Some floors are not level. For proper baking, your range must be level. The leveling legs are located on each corner of the base of the range.

Place a level horizontally on an oven rack and check front-to-back and side-to-side. Level the range by turning the legs.

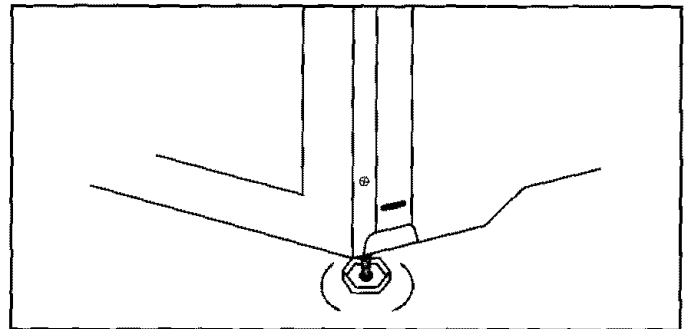

WARNING: To reduce the risk of accidental tipping of the range, it must be secured by an anti-tip device. To check if the device is installed properly, use a flashlight and look underneath the range to see that one of the rear leveling legs is engaged in the bracket slot.

Light Replacement

Before replacing the oven or panel light bulb, **disconnect power to range**. Be sure the bulb and range parts are cool. Do not touch a hot bulb with a damp cloth as the bulb may break.

To Replace Panel Light (select models)

Grasp the top trim of the back panel with your thumbs under the front edge and pull outward while lifting the trim. Remove the bulb and replace it with an 18 watt fluorescent tube. Snap the top trim back into place and restore the power. Reset the clock.

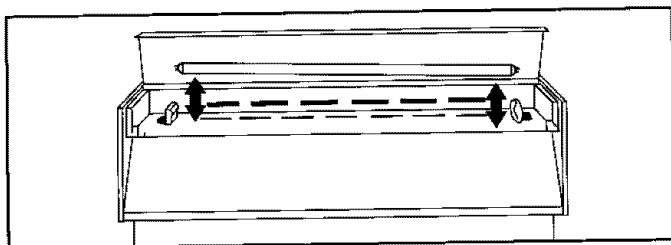

To Replace Oven Light

Carefully unscrew the lens cover with a dry potholder. Very carefully remove the bulb with the potholder. Replace with a 40 watt appliance bulb. Reconnect the power to the range and reset the clock.

Oven Door

To Remove: Open the door to the “stop” position (opened about 6 inches) and grasp the door with both hands at each side. Do not use the door handle to lift the door. Lift up evenly until the door clears the hinge arms.

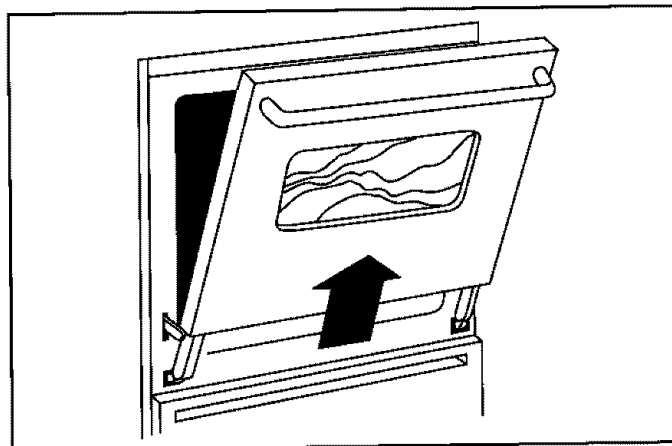

CAUTION: Hinge arms are spring mounted and will slam shut against the range if accidentally hit. **Never place your hand or fingers between the hinges and the front oven frame.** You could be injured if the hinge snaps back.

To Replace: Grasp the door at each side, align the slots in the door with the hinge arms and slide the door down onto the hinge arms until it is completely seated on the hinges.

Do not attempt to open or close the door until the door is completely seated on the hinge arms. Never turn the oven on unless the door is properly in place. When baking, be sure the door is completely closed. Baking results will be affected if the door is not securely closed.

BEFORE YOU CALL FOR SERVICE

Check these points if...

Part or all of your electric range does not operate

- Is the range plug loose or disconnected from the electrical outlet (if not wired direct to the electrical supply)?
- Are any house fuses blown or circuit breakers tripped?
- Has the power supply to the home been interrupted?
- Are the oven controls properly set?
- Was the door left in the locked position following a self-clean cycle?
- Is the oven set for a programmed operation?

Surface elements fail to turn on or heat the food properly

- Is the range plug loose or disconnected from the electrical outlet (if not wired direct to the electrical supply)?
- If the range has coil elements, are they properly plugged into the receptacles?
- Were appropriate pans used? (See “Cooking Made Simple” booklet.)
- Are the surface element controls properly set?
- Is the self-clean cycle operating and therefore overriding the surface cooking abilities (Canadian ranges only)?

Food not baking correctly

- Are the oven racks properly placed for baking? (See Rack Positions, pages 10–11.)
- Have you used aluminum foil correctly?
- Was the oven preheated as recommended?
- Are the controls for bake operations properly set?
- Is there 1 to 2 inches of space between pans and the oven walls? Are the range and oven racks level?
- Was good cookware/bakeware of the proper size used? (See “Cooking Made Simple” booklet.)
- Are you using a tested recipe from a reliable source? The oven thermostat on your new range may be more accurate than the one on your old range.
- Was the oven vent covered or blocked on the range surface?
- Did you check the food at the minimum cooking time to avoid overbaking?

For Convection—

- Did you reduce oven temperature by 25°F?

Food does not broil properly

- Are the controls for broiling set properly? (See Broiling section, page 12.)
- Was the proper rack position used? (See Broiling section, page 12.)
- Did you allow time for the broil element to preheat?
- Was the broiler pan received with the range used?
- Was aluminum foil used on the broiler pan insert, blocking the slits for fat drainage?
- Was the correct electric voltage available?

Oven light does not operate

- Is the bulb loose or burned out?
- Is the light switch in the On position?

Oven will not self-clean

- Is the self-clean control set properly? (See Self-Clean instructions, pages 14–15.)
- Is the oven set for a programmed oven operation?

Oven door won't latch

- Are the proper controls set for the self-clean cycle? (See Self-Clean instructions, pages 14–15.)

Oven door will not unlock

- Has the self-clean cycle been finished for at least one hour?

“F” plus a number appears in the display

- These are fault codes. If a fault code appears in the display and a continuous beep sounds, press the CANCEL pad. If the fault code reappears, disconnect power to the range and call a qualified service technician.

Cooling fan sound (slide-in models)

- A fan will automatically turn on when the oven is operated to cool the clock controls. This is normal. The fan may continue to run even after the oven is turned off.

Convection fan not operating during convection cooking

- Are the controls for convection set properly? (See pages 10–11.)

For further assistance contact your Maytag dealer or call Maytag Customer Service:

U.S. 1-800-688-9900

CANADA 1-800-688-2002

RANGE WARRANTY

Full One Year Warranty

For **one (1) year** from the date of original retail purchase, any part which fails in normal home use will be repaired or replaced free of charge.

Limited Warranty

Second Year

After the first year from the date of original retail purchase through the second year, parts which fail in normal home use will be repaired or replaced free of charge for the part itself, with the owner paying all other costs, including labor, mileage and transportation.

Third Through Fifth Year

After the second year from the date of original retail purchase through the fifth year, all of the following components which fail in normal home use will be repaired or replaced free of charge for the part itself, with the owner paying all other costs, including labor, mileage and transportation.

These components include:

All Electronic Clocks: on electric or gas ranges.

Electric Heating Elements: Includes all surface elements (coil and smooth top), glass cooking surfaces, broil elements and oven bake elements on electric ranges.

Third Through Tenth Year

After the second year from the date of original retail purchase through the tenth year, sealed gas burners on gas ranges which fail in normal home use will be repaired or replaced free of charge for the part itself, with the owner paying all other costs, including labor, mileage and transportation.

Canadian Residents

This warranty covers only those ranges installed in Canada that have been listed with Canadian Standards Association unless the ranges are brought into Canada due to transfer of residence from the United States to Canada.

Limited Parts Warranty Outside United States Or Canada

For appliances located outside the United States and Canada, the **only** warranty provided with the appliance is as follows: For two (2) years from the date of original retail purchase, any part which fails in normal home use will be repaired or replaced free of charge for the part itself, with the owner paying all other costs, including labor, mileage and transportation.

The specific warranties expressed above are the **only** warranties provided by the manufacturer. This warranty gives you specific legal rights, and you may also have other rights that vary from state to state.

To Receive Warranty Service

To locate an authorized service company in your area contact the Maytag dealer from whom your appliance was purchased; or call Maytag Customer Service. Should you not receive satisfactory warranty service, call or write:

Maytag Customer Assistance
% Maytag Customer Service
P.O. Box 2370
Cleveland, TN 37320-2370
US 1-800-688-9900
CANADA 1-800-688-2002

When contacting Maytag Customer Service be sure to provide the model and serial numbers of your appliance, the name and address of the dealer from whom you purchased the appliance and the date of purchase.

Should you still have a problem, write to: Major Appliance Consumer Action Program, 20 North Wacker Drive, Chicago, Illinois 60606. MACAP is an industry sponsored but independent group of consumer experts who receive and act on complaints from appliance owners.

NOTE: When writing about an unsolved service problem, please include the following information:

- (a) Your name, address and telephone number;
- (b) Model number and serial number (found on the data plate) of your appliance;
- (c) Name and address of your dealer and date the appliance was bought;
- (d) A clear description of the problem you are having.

MAYTAG • One Dependability Square • Newton, Iowa 50208