

REFRIGERATED AND NON-REFRIGERATED COLD PAN AND FROST TOP DROP-INS

Thank you for purchasing this Vollrath® product! Save this manual for reference and the packaging in case shipping is necessary.

SAFETY PRECAUTIONS

To help ensure safe use, please read and fully understand this manual and all safety messages before operation!

WARNING

Warning indicates a hazardous situation which, if not avoided, could result in death or serious injury.

CAUTION

Caution indicates a hazardous situation which, if not avoided, could result in minor or moderate injury.

NOTICE: addresses practices not related to physical injury.

To reduce risk of injury or damage to the unit

- Equipment must be installed by a qualified person.
- Use only grounded electrical circuits and outlets that match the nameplate-rated voltage. Do not use extension cords or power strips of any kind.
- Never modify the wiring, cord, or plug. This could damage the unit and cause injury and will void the warranty.
- Use in a flat, level position.
- Keep unit and power cord away from open flames, electric burners, and excessive heat.
- Use pans 6" (15.2 cm) or less in depth.
- Only operate properly functioning, undamaged units.
- Always attend the unit when operating.
- Do not set anything on the top surface.

UL GUIDANCE FOR PRODUCTS WITH R290 REFRIGERANT

This product utilizes R290 Refrigerant. Follow all safety precautions for use of R290.

Per UL, the following is an explanation of the characters marked on the appliance. All models are Test Room Climate Class 5.

FC-4CWW-0XYYY-ZZZ

- FC: Fabricator Component
- 4: Series
- CWW: C = normal pan orientation, CS = 90 degree pan orientation, P = Propane R290 refrigerant
- 0X: X = Number of full-size food pans 1 - 6
- YYY: Voltage
- ZZZ: N = NSF Std 7 compliant, R = standard refrigerated, FF = top panel with flat flange



WARNING

Do not store explosive substances such as aerosol cans with a flammable propellant in this appliance..

UL GUIDANCE FOR PRODUCTS WITH R290 REFRIGERANT CONTINUED



WARNING

Keep clear of obstruction all ventilation openings in the appliance enclosure or in the structure for building-in.



WARNING

Do not use mechanical devices or other means to accelerate the defrosting process.



WARNING

Do not damage the refrigerating circuit.



WARNING

Do not use electrical appliances inside the food/ice storage compartments.



WARNING

Component parts shall be replaced with like components so as to minimize the risk of possible ignition due to incorrect parts.



WARNING

Appliance is to be installed in accordance with the Safety Standard for Refrigeration Systems, ANSI/ASHRAE 15.



WARNING

- Do not use means to clean, other than those recommended by Vollrath®.
- The appliance shall be stored in a room without continuously operating ignition sources (for example: open flames, an operating gas appliance or an operating electric heater).
- Do not pierce or burn.
- Be aware that refrigerants may not contain an odor.



WARNING

Prior to beginning work on systems containing FLAMMABLE REFRIGERANTS, safety checks are necessary to ensure that the risk of ignition is minimized. For repair to the REFRIGERATING SYSTEM, the following steps shall be completed prior to conducting work on the system.

Work procedure

- Work shall be undertaken under a controlled procedure so as to minimize the risk of a flammable gas or vapour being present while the work is being performed.

General work area

- All maintenance staff and others working in the local area shall be instructed on the nature of work being carried out. Work in confined spaces shall be avoided.

Checking for presence of refrigerant

- The area shall be checked with an appropriate refrigerant detector prior to and during work, to ensure the technician is aware of potentially toxic or flammable atmospheres. Ensure that the leak detection equipment being used is suitable for use with all applicable refrigerants, i.e., non-sparking, adequately sealed, or intrinsically safe.

Presence of fire extinguisher

- If any hot work is to be conducted on the refrigerating equipment or any associated parts, appropriate fire extinguishing equipment shall be available on hand. A dry chemical or CO2 fire extinguisher should be adjacent to the charging area.

No ignition sources

- No person carrying out work in relation to a REFRIGERATING SYSTEM which involves exposing any pipe work shall use any sources of ignition in such a manner that it may lead to the risk of fire or explosion. All possible ignition sources, including cigarette smoking, should be kept sufficiently far away from the site of installation, repairing, removing and disposal, during which refrigerant can possibly be released to the surrounding space. Prior to work taking place, the area around the equipment shall be surveyed to make sure that there are no flammable hazards or ignition risks. "No Smoking" signs shall be displayed.

Ventilated area

- Ensure that the area is in the open or that it is adequately ventilated before breaking into the system or conducting any hot work. A degree of ventilation shall continue during the period that the work is carried out. The ventilation should safely disperse any released refrigerant and preferably expel it externally into the atmosphere.

Checks to the refrigerating equipment

- Where electrical components are being changed, they shall be fit for the purpose and to the correct specification. At all times, Vollrath® maintenance and service guidelines shall be followed. If in doubt, consult the Vollrath® technical department for assistance.

The following checks shall be applied to installations using FLAMMABLE REFRIGERANTS:

- A. The actual REFRIGERANT CHARGE is in accordance with the room size within which the refrigerant containing parts are installed,
- B. The ventilation machinery and outlets are operating adequately and are not obstructed,
- C. If an indirect refrigerating circuit is being used, the secondary circuit shall be checked for the presence of refrigerant,
- D. Marking to the equipment continues to be visible and legible. Markings and signs that are illegible shall be corrected,
- E. Refrigerating pipe or components are installed in a position where they are unlikely to be exposed to any substance which may corrode refrigerant containing components, unless the components are constructed of materials which are inherently resistant to being corroded or are suitably protected against being so corroded.

Checks to electrical devices

Repair and maintenance to electrical components shall include initial safety checks and component inspection procedures. If a fault exists that could compromise safety, then no electrical supply shall be connected to the circuit until it is satisfactorily dealt with. If the fault cannot be corrected immediately but it is necessary to continue operation, an adequate temporary solution shall be used. This shall be reported to the owner of the equipment, so all parties are advised. Initial safety checks shall include:

- A. That capacitors are discharged: this shall be done in a safe manner to avoid possibility of sparking;
- B. That no live electrical components and wiring are exposed while charging, recovering or purging the system;
- C. That there is continuity of earth bonding.





WARNING

Repairs to sealed components

- During repairs to sealed components, all electrical supplies shall be disconnected from the equipment being worked upon prior to any removal of sealed covers, etc. If it is absolutely necessary to have an electrical supply to equipment during servicing, then a permanently operating form of leak detection shall be located at the most critical point to warn of a potentially hazardous situation.
- Particular attention shall be paid to the following to ensure that by working on electrical components, the casing is not altered in such a way that the level of protection is affected. This shall include damage to cables, excessive number of connections, terminals not made to original specification, damage to seals, incorrect fitting of glands, etc.

Ensure that the apparatus is mounted securely.

- Ensure that seals or sealing materials have not degraded to the point that they no longer serve the purpose of preventing the ingress of flammable atmospheres. Replacement parts shall be in accordance with the manufacturer’s specifications.

Cabling

- Check that cabling will not be subject to wear, corrosion, excessive pressure, vibration, sharp edges, or any other adverse environmental effects. The check shall **also take into account the effects of aging or continual vibration** from sources such as compressors or fans.

Detection of flammable refrigerants

Under no circumstances shall potential sources of ignition be used in the searching for or detection of refrigerant leaks. A halide torch (or any other detector using a naked flame) shall not be used.

The following leak detection methods are deemed acceptable for all refrigerant systems:

- Electronic leak detectors may be used to detect refrigerant leaks but, in the case of FLAMMABLE REFRIGERANTS, the sensitivity might not be adequate, or might need re-calibration. (Detection equipment shall be calibrated in a refrigerant-free area.) Ensure that the detector is not a potential source of ignition and is suitable for the refrigerant used. Leak detection equipment shall be set at a percentage of the LFL of the refrigerant and shall be calibrated to the refrigerant employed, and the appropriate percentage of gas (25 % maximum) is confirmed.
- Leak detection fluids are also suitable for use with most refrigerants but the use of detergents containing chlorine shall be avoided as the chlorine can react with the refrigerant and corrode the copper pipe-work.
- If a leak is suspected, all naked flames shall be removed/extinguished.
- If a leakage of refrigerant is found which requires brazing, all of the refrigerant shall be recovered from the system, or isolated (by means of shut off valves) in a part of the system remote from the leak.





WARNING

Decommissioning

Before carrying out this procedure, it is essential that the technician is completely familiar with the equipment and all its detail. It is recommended good practice that all refrigerants are recovered safely. Prior to the task being carried out, an oil and refrigerant sample shall be taken in case analysis is required prior to re-use of recovered refrigerant. It is essential that electrical power is available before the task is commenced.

- A. Become familiar with the equipment and its operation.
- B. Isolate the system electrically.
- C. Before attempting the procedure, ensure that:
 - i. Mechanical handling equipment is available, if required, for handling refrigerant cylinders;
 - ii. All personal protective equipment is available and being used correctly;
 - iii. The recovery process is supervised at all times by a competent person;
 - iv. Recovery equipment and cylinders conform to the appropriate standards.
- D. Pump down refrigerant system, if possible.
- E. If a vacuum is not possible, make a manifold so that refrigerant can be removed from various parts of the system.
- F. Make sure that cylinder is situated on the scales before recovery takes place.
- G. Start the recovery machine and operate in accordance with instructions.
- H. Do not overfill cylinders (no more than 80 % volume liquid charge).
- I. Do not exceed the maximum working pressure of the cylinder, even temporarily.
- J. When the cylinders have been filled correctly and the process completed, make sure that the cylinders and the equipment are removed from site promptly and all isolation valves on the equipment are closed off.
- K. Recovered refrigerant shall not be charged into another REFRIGERATING SYSTEM unless it has been cleaned and checked.
- L. Labelling: Equipment shall be labelled stating that it has been de-commissioned and emptied of refrigerant. The label shall be dated and signed. For appliances containing FLAMMABLE REFRIGERANTS, ensure that there are labels on the equipment stating the equipment contains FLAMMABLE REFRIGERANT.

REFRIGERATED AND NON-REFRIGERATED COLD PAN AND FROST TOP DROP-INS





FUNCTION & PURPOSE

Cold pan models are intended to keep food at proper serving temperatures in locations with ambient temperatures below 86 °F (30 °C). Using them in warmer temperatures will take units out of NSF compliance. Modifying refrigeration parameters may void the warranty.

Frost Tops are intended to hold plates of pre-chilled food and beverages for short periods of time and are not intended to have direct contact with food.

Food must be prepared and placed into the food station at proper serving temperatures. refrigerated units are best used for holding periods up to four hours. For best performance, stainless steel containers are recommended.

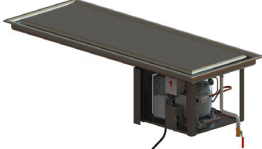
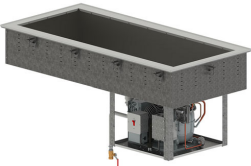
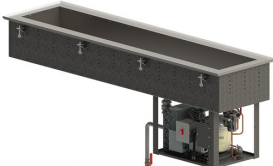
Units are not intended to chill hot food, nor for household, industrial, or laboratory use.

Refrigerated Pans		Short Side Refrigerated Pans		Non-Refrigerated Pans		Refrigerated Frost Tops	
 NSF		 NSF		 Standard		 Frost Top	
Item	Pans	Item	Pans	Item	Pans	Item	Pans
FC-4CP-01120-N	1	FC-4CSP-02120-N	2	36491	1	FC-4CP-02120-F	2
FC-4CP-02120-N	2	FC-4CSP-03120-N	3	36450	2	FC-4CP-03120-F	3
FC-4CP-03120-N	3	FC-4CSP-04120-N	4	36451	3	FC-4CP-04120-F	4
FC-4CP-04120-N	4			36452	4	FC-4CP-05120-F	5
FC-4CP-05120-N	5			36453	5	FC-4CP-06120-F	6
FC-4CP-01620-N	6			36454	6	UNPACKING THE UNIT <ol style="list-style-type: none"> 1. Remove all packing material, tape, and protective plastic. 2. Clean any glue residue left over from the plastic or tape. 3. Place unit in desired location. 4. Plug unit into a properly grounded electrical supply matching the nameplate rating. NOTICE: Using incorrect voltage can cause damage and will void the warranty. 	
 Standard		 Standard		 Short Side			
Item	Pans	Item	Pans	Item	Pans		
FC-4CP-01120-R	1	FC-4CSP-02120-R	2	36654	2		
FC-4CP-02120-R	2	FC-4CSP-03120-R	3	36657	3		
FC-4CP-03120-R	3	FC-4CSP-04120-R	4	36660	4		
FC-4CP-04120-R	4	BEFORE FIRST USE <ol style="list-style-type: none"> 1. Clean and dry unit per the Cleaning and Maintenance Section. 					
FC-4CP-05120-R	5						
FC-4CP-06120-R	6						

RECORD YOUR SERIAL NUMBER

The serial number for this equipment can be found on the rating plate located below the well, near the power cord. To aid in future communication about your product, please record the serial number in the space below.

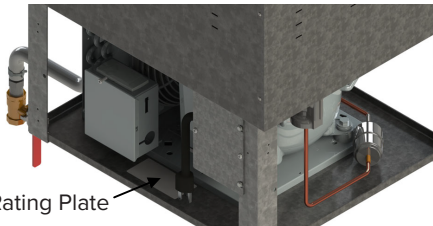
 <p>Rating Plate</p>	<p>Serial Number:</p>
---	-----------------------



LOCATION & INSTALLATION

- Refer to the included installation instructions and the specification sheet which can be found on vollrathfoodservice.com.
- Do not move the unit by pushing or pulling on the breath guard (if it is present).
- Place and operate unit in a flat, level position.
- A minimum of 3" (7.6 cm) of clearance is required in front of each vent to prevent overheating.

FEATURES AND CONTROLS

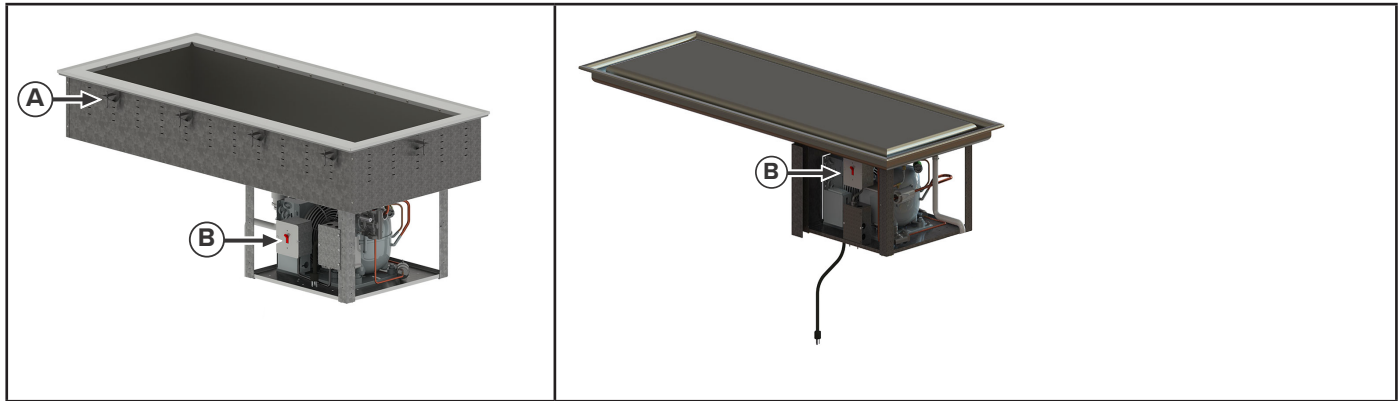

A. Mounting Clip—aids with the installation in a countertop.

B. On/Off Switch—turns unit as a whole on or off when flipped. Well Displays will illuminate to show the value from the last use.

OPERATION



WARNING

Electrical Shock Hazard.

Keep water and other liquids from entering the unit. Liquid inside the unit could cause an electrical shock or short circuit. Do not immerse the cord, plug, or unit in water or any other liquid—or operate if the unit or cord are damaged or altered.

NOTICE: Using voltage other than the nameplate-rated voltage or modifying the cord or any electrical component will damage the unit and void the warranty.

General Guidelines

- For best performance, prevent drafts or room air currents from flowing over food pans.
- Do not use food pans deeper than 6" (15.2 cm).
- Do not place hot items on the top surface.
- Do not heap, mound, overfill, or elevate pans. This will take the unit out of NSF compliance.

Pre-Chill & Hold Chilled Food

1. Cover and refrigerate pans with food to be served cold.
2. Plug the power cord into an outlet that matches the nameplate rating and turn the unit on with the On/Off Switch.
3. For refrigerated models, run unit for about 30 minutes before adding chilled food and for two hours if adding ice.
4. For non-refrigerated models, Place ice into the pan and allow the pan to chill for 1 hour before use.
5. Ensure food is at proper serving temperatures, then place containers of cold food into pre-chilled well.

NOTICE: Monitor food temperature closely for food safety. The United States Public Health Service recommends that cold food be held at a maximum of 41 °F (5 °C).

6. When finished using the unit, flip the power switch to off.
7. Remove food containers and dispose of leftovers or store appropriately for food safety.

DAILY CLEANING

	<h1>WARNING</h1>
<p>Electrical Shock Hazard. Keep water and other liquids from entering unit. Liquid inside unit could cause an electrical shock or short circuit. Do not immerse cord, plug, or unit in water or any other liquid—or operate if the unit or cord are damaged or altered.</p>	

NOTICE: Do not use caustic cleaning chemicals, steel wool or commercial products to clean the unit.

1. Remove food containers.
2. Turn the unit off with the On/Off switch and allow unit to defrost at room temperature.
3. If you have a drain hose and valve (not provided), place drain hose into a bucket of sufficient size, then open the Drain Valve to empty the water from the well.
4. Soak up residual water with a clean cloth.
5. Use a damp cloth or sponge dipped in soapy water to wipe the inside of the well and outside of unit.
6. Thoroughly rinse unit with clean water, then dry thoroughly.

TROUBLESHOOTING

Problem	Potential Cause	Course of Action
Drop-In or wells do not turn on.	Unit does not have power.	Plug in unit.
	Circuit breaker tripped.	Reset the circuit breaker; contact Vollrath Technical Service if the problem persists.
	Circuit is defective or power supply is not correct.	Contact Vollrath Technical Service.
Unit has power, but is not operating.	Component malfunctioned.	Contact Vollrath Technical Service.
	Ambient air temperature is too high.	Reduce ambient air temperature to below 86 °F (30 °C)???
	Warm or cool air currents are affecting operation.	Reduce/regulate air currents or move unit to consistent area.

SERVICE AND REPAIR

Serviceable parts are available on vollrathfoodservice.com.

To avoid serious injury or damage, never attempt to repair the unit or replace a damaged power cord yourself. Do not send units directly to The Vollrath Company LLC. Please contact Vollrath Technical Services for instructions.

When contacting Vollrath Technical Service, please be ready with the item number, model number (if applicable), serial number, and proof of purchase showing the date the unit was purchased.

WARRANTY STATEMENT FOR THE VOLLRATH CO. L.L.C.

The Vollrath Company LLC warrants to the original commercial end user that each of Vollrath's foodservice products will be free from defects in materials and workmanship.

For warranty period, exclusions, and details, visit vollrathfoodservice.com/vollrath-resources/warranty-info/warranty-policy.

VOLLRATH®

The Vollrath Company, L.L.C.

1236 North 18th Street
Sheboygan, Wisconsin 53081-3201 USA
Main Tel: 800.624.2051 or 920.457.4851
Main Fax: 800.752.5620 or 920.459.6573
Customer Service: 800.628.0830
Canada Customer Service: 800.695.8560

Technical Services

techservicereps@vollrathco.com
Induction Products: 800.825.6036
Countertop Warming Products: 800.354.1970
All Other Products: 800.628.0832