

HOTO Wand™
Cordless Spin Scrubber
12-Piece Ultimate Kit

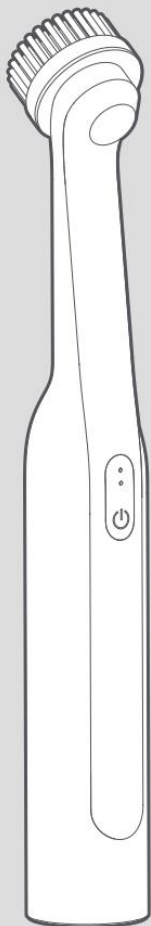

**Make It
Happen**



Visit our website for more Cool Tools
(www.hototools.com)

01 Product Introduction

Please carefully read the Instructions for Use and keep it properly.

Thanks for choosing HOTO Wand Cordless Spin Scrubber 12-Piece Ultimate Kit.
The image is only for your reference.
The actual product shall prevail.

- | | |
|-----------------------------|--------------------------|
| ① Brush-M | ⑦ Cloth pad * |
| ② Brush-L | ⑧ USB-C® charging port * |
| ③ Brush-S | ⑨ Hook |
| ④ Pointed brush | ⑩ Gear indicator light |
| ⑤ Scour pad | ⑪ Standby & Gear button |
| ⑥ Velcro adapter for pads * | ⑫ Non-slip texture |

* USB Type-C® and USB-C® are registered trademarks of USB Implementers Forum

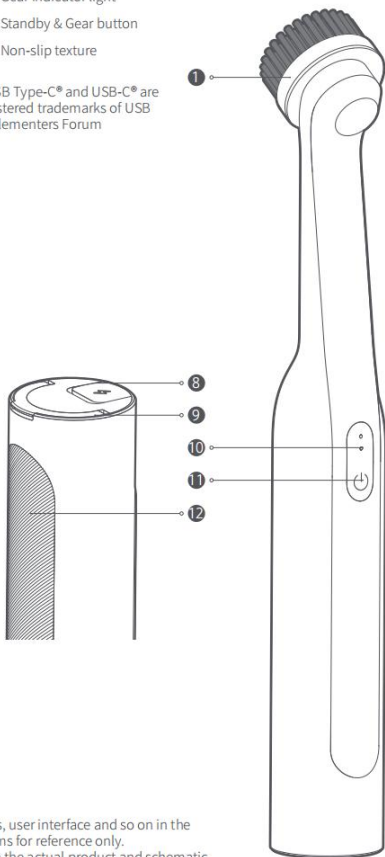
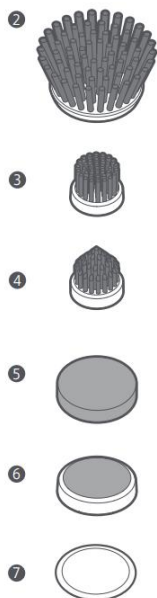

* Attach the scour pad to the Velcro base.

* The illustrations of products, accessories, user interface and so on in the Instructions for Use are schematic diagrams for reference only.

* There may be slight differences between the actual product and schematic diagrams due to product updates and upgrades. The actual product shall prevail.

* Do not forcibly stop the brush head from rotating with your hand.

02 Use of Scrubber Heads



Brush-S (hard bristles):
It is suitable for cleaning tile grout, bathroom floor drains, drain pipes and kitchen filters.



Brush-M (medium hard bristles):
It is suitable for cleaning washing machine waterproof strips, terrace grills, etc.



Brush-L (medium soft bristles):
It is suitable for cleaning ovens, hob, bathroom sinks, shoes (excluding leather shoes), tires, and other fine articles.



Pointed brush (hard bristles):
It is suitable for cleaning tile grout, toilet crevices, shower nozzles, faucet corners and other narrow corners.



Scour pad:
It is suitable for cleaning narrow corners around ovens, hob, etc.



Velcro adapter for pads:
With a fabric paster, it is used with replaceable scour pads, cloth pad.



Cloth pad:
Perfect for small corners on glass, mirrors, etc. It can also be used to polish delicate household items, such as plates, silverware, and sneakers.

*** Caution:**

Before using the pointed brush and large brush, it is recommended to start with a low-speed setting for the best cleaning results.

To prevent scratching or damaging the item being cleaned, choose an appropriate scrubber head. Before use, always test on a small, inconspicuous area to ensure safety.

03 Use of Product

Placement

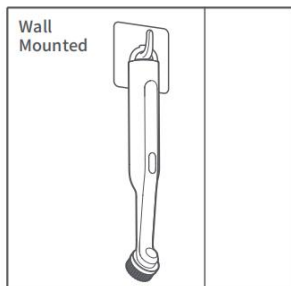
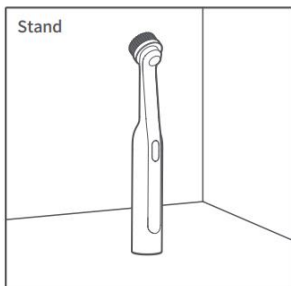

Installation of scrubber heads

Scrubber heads are magnetic, allowing easy installation with light pressure. To remove a head, just pull it off.

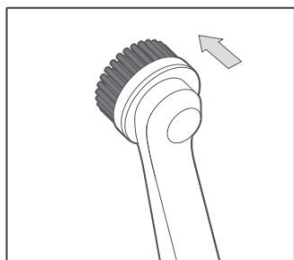
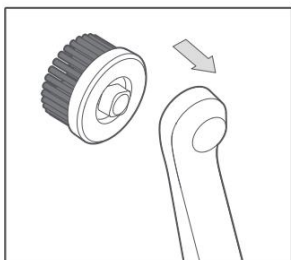

Power on/off

Press and hold the standby button to power on/off

Gear switch

When the machine is working, press the standby button for gear switch.

High-gear mode: Two LED lights stay on.

Low-gear mode: One LED light stays on.

* Before use, make sure the USB-C charging port's waterproof rubber seal is closed.

Machine status and LED display

Machine status	LED display mode
Low speed operation with battery level greater than 20%	Single indicator light remains on in white
High speed operation with battery level greater than 20%	Two indicator lights remain on in white
Low speed operation with battery level less than or equal to 20%	Single indicator light remains on in red
High speed operation with battery level less than or equal to 20%	Two indicator lights remain on in red
Charging	Two indicator lights flicker in white
Fully charged	Two indicator lights remain on in white and go off after one minutes (when the charger is connected and not working)

Charging

Fully charge this product before first use. Charge the product with a USB-C charging cable and a compatible power adapter.

The product is provided with a USB-A to USB-C charging cable.

* Do not use the product while it is charging.

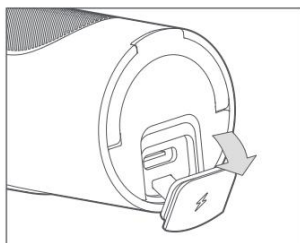

04 Cautions

1. Keep the product out of the reach of children and pets.
2. Do not use the product with flammable substances.
3. Do not use this product to clean humans or animals.
4. Make sure the USB-C charging port's waterproof rubber seal is closed before use.
5. Before use, test the product in an inconspicuous area to prevent the risk of scratching or damage.
6. This product is not a toy and must not be used by children. Users are recommended to be at least 16 years of age.
7. This product is a household cleaning tool and is not suitable for use in industrial or other harsh environments.
8. The waterproof IP rating of the main body is IPX7. The brush head does not contain electronic components. This part is not waterproof, but it does not affect normal use.
9. If excessive resistance causes the motor to pause or stop during use, power off the machine and then reboot it. If it still fails, please contact customer service.
10. If the main body's coupling is damaged, do not use the product and promptly contact customer service.
11. When charging, do not place the product in high-temperature environments.
12. Do not disassemble the product without permission.
13. If the product has been idle for a long period, fully charge it before use. If the product will be idle for a long period, charge it every six months.
14. Please use the product according to the Instructions for Use to avoid unnecessary injury to the product or user.
15. Properly recycle and dispose of the battery pack in an environmentally friendly manner. Before removing the battery pack, ensure the machine is powered off.
16. When cleaning the plastic parts of scrubbers, avoid rubbing them against surfaces to prevent friction marks.
17. Different scrubber heads are suitable for different surfaces. Please refer to the Instructions for Use to avoid incorrect use.
18. When using, please ensure a safe distance from any loose hair around to prevent the brush head from entangling hair during rotation.
19. Avoid using strong acid or alkali cleaners during use, as they may cause the product to crack or become damaged.
20. It is recommended to use a neutral cleaner to ensure the safety and durability of the product for long-term use.

05 Safety Warnings

Warning! Read all safety warnings and instructions marked with symbols. Failure to comply with the instructions listed below may result in electric shocks, fire or serious injury. Save all warnings and instructions for reference.

Safety warning for general electric tools - workplace safety

- **Keep the workplace clean and bright.** As a messy and dark workplace may result in accidents.
- **Stay away from children and bystanders while operating electric tools.** Inattention may cause you to lose control of the tool.

Safety warning for general electric tools - electrical safety

- **Do not expose electric tools to rain or wetness environment.** Water getting inside electric tools will increase the risk of electric shock.

Safety warning for general electric tools - personnel safety

- **Keep alert, and pay attention and stay sober while operating electric tools. Do not operate electric tools when you feel tired or have drug, alcohol or treatment responses.** A moment of negligence during the operation of electric tools may lead to serious bodily injury.
- **An unexpected start is prevented. Make sure that the switch is off before you connect the power supply or battery pack and pick up or carry tools.** It can be dangerous if you put your fingers on the switch when you carry tools or when the switch is on.
- **Do not stretch your hands too much. Always pay attention to the foothold and body balance.** In this way, electric tools can be better controlled under unexpected circumstances.
- **Dress properly. Do not wear loose clothes or accessories.** Keep your hair and clothes away from moving parts. Loose clothes, accessories or long hair may get caught in moving parts.
- **Do not lower your guard due to the familiarity caused by frequent use of tools, and ignore the safety criterion of tools.** A careless action may lead to serious injury in an instant.

Safety warning for general electric tools - the use and precautions of electric tools

- Do not use electric tools reluctantly. Use appropriate electric tools according to the purpose. Selecting an appropriate electric tool designed according to its rated value will enhance the effectiveness and safety of your work.
- If the switch cannot be turned on or off the power supply, the electric tool cannot be used. Electric tools that cannot be controlled through switches are dangerous and must be repaired.
- Before any adjustment, replacement of accessories or storage of electric tools, the plug must be unplugged and/or the battery pack (if detachable) must be removed from the power supply. This protective safety measure reduces the risk of accidental activation of electric tools.
- Keep unused electric tools out of children's reach, and do not allow people who are not familiar with electric tools and do not understand these instructions to operate electric tools. Electric tools are dangerous for untrained users.
- Maintenance of electric tools and their accessories. Check whether the moving parts are adjusted in place or stuck, and check the damage to the parts and other conditions that affect the operation of electric tools. In case of any damage, repair the electric tools before use. Many accidents are caused by poor maintenance of electric tools.
- Keep the handle and grip surface dry and clean, and not be stained with grease. In case of accidents, the slippery handle cannot guarantee the safety of grip and control of tools.

Safety warning for general electric tools - the use and precautions of battery-type electric tools

- Charge only with the charger specified by the producer. Fire hazard may occur when chargers suitable for one battery pack are used in other battery packs.
- Under abuse, contact shall be avoided as liquid may splash out of the battery pack. If you touch the liquid accidentally, rinse it with water. If the liquid touches your eyes, seek medical help. Liquid splashing out of the battery may cause corrosion or burn.
- Do not use damaged or refitted battery packs or tools. Damaged or refitted battery packs may present unpredictable results, resulting in fire, explosions or injury.
- Do not expose battery packs to fire or high temperature. Exposure of battery packs to fire or high temperatures above 130°C may result in explosion.

Safety warning for general electric tools - maintenance

- Make professional maintenance personnel repair electric tools with same spare parts. This can ensure the safety of electric tools repaired. Never repair damaged electric tools. The battery packs can only be repaired by the producer or its authorized maintenance service provider.

Safety warnings for the built-in batteries of tools

- Do not disassemble, open or chop tools.
- Do not expose tools to heat sources or flames. Avoid storage in direct sunlight.
- Do not make the exposed terminal of the tool have a short circuit. Do not place multiple tools into the box or drawer at will, in order to avoid short circuit among them or by other metal objects.
- It is forbidden to make tools undergo mechanical shock.
- If the battery leaks, avoid making the leaked liquid come into contact with your skin or eyes. In case of contact, rinse the affected area with a large amount of water and seek medical help promptly.
- Do not use non-device special chargers.
- Keep tools away from children.
- Do not use non-device special batteries.
- Keep tools clean and dry.
- If the tool's charging terminal gets dirty, wipe it with a clean and dry cloth.
- Charge the tool before use. Charge using the proper charger and according to the instructions of the manufacturer or the proper instructions in the user manual of the equipment.
- Do not charge the tool for a long time when it is not in use.
- After long-term storage, charge and discharge the tools multiple times to achieve optimal performance.
- The battery has the best performance using at normal temperature (20°C ± 5°C).
- Save the original instructions of the product for reference in future.
- Dispose of the battery properly. Before disposing of the product, the battery must be removed from the product by a professional and disposed of safely.

Faults and troubleshoot

Fault	Cause	Troubleshooting
Equipment does not work	The lithium battery runs low	Please charge the device in time
Sudden halt during use	The lithium battery runs low	Please charge the device in time
Battery cannot be charged	The USB cable is not plugged in properly, or the charging cable is not the designated one	Check whether the charging indicator light is on, plug in the USB cable, and use the charging voltage specified in the product parameters.
The scrubber stops rotating	Excessive pressing force to the scrubber during use will trigger a protective action	Reboot the product

06 Basic Parameters

Product name: HOTO Wand Cordless Spin Scrubber 12-Piece Ultimate Kit

Product model: QWQJA07

Product dimension:

Approx. 35mm×35.75mm×253.84mm (excluding scrubber heads) (Approx. 1.38×1.41×10 in)

Net weight: Approx. 177.5g

(excluding scrubber heads) (Approx. 0.39lb)

Product color: Grey black

Typical Low gear no-load speed: 170 ±10% r/min

Typical High gear no-load speed: 250 ±10% r/min

Waterproof: IPX7

Battery type: Lithium-ion battery

Battery capacity: 2000mAh 7.2Wh

Rated input: 5V ---1A

Nominal voltage: 3.6V ---

Charging duration: Approx. 180min

Storage temperature: -10°C–45°C

Operating temperature: -10°C–45°C

Charging temperature: 5°C–40°C

Product accessories:

Brush-S: Approx. 24×φ24 mm (0.95×φ0.95 in)

Brush-M: Approx. 24×φ36.5 mm (0.95×φ1.44 in)

Brush-L: Approx. 29.5×φ45 mm (1.16×φ1.77 in)

Pointed brush: Approx. 27×φ24 mm (1.06×φ0.95 in)

Scour pad: Approx. 8×φ40 mm (0.31×φ1.57 in)

Cloth pad: Approx. 8×φ40 mm (0.31×φ1.57 in)

Velcro adapter for pads: Approx. 8×φ33.6 mm (0.31×φ1.32 in)

Brush head bag: Approx. 100×200 mm (3.94×7.87in)

Charging cable: USB-A to USB-C / 300 mm (11.81 in) / black

07 Regulatory Compliance Information

Europe — EU declaration of conformity



We, Shanghai HOTO Technology Co., Ltd., hereby, declare that this equipment is in compliance with the applicable Directives and European Norms, and amendments.

Disposal and recycling information



All products bearing this symbol are waste electrical and electronic equipment (WEEE as in directive 2012/19/EU) which should not be mixed with unsorted household waste. Instead, you should protect human health and the environment by handing over your waste equipment to a designated collection point for the recycling of waste electrical and electronic equipment, appointed by the government or local authorities. Correct disposal and recycling will help prevent potential negative consequences to the environment and human health. Please contact the installer or local authorities for more information about the location as well as terms and conditions of such collection points.

Notes for packaging



The packaging materials are recyclable. Please dispose of packaging in an environmentally friendly manner.

DECLARATION OF CONFORMITY



EU Declaration of Conformity
We

Shanghai HOTO Technology Co., Ltd.

Declare that the product:

HOTO Wand Cordless Spin Scrubber 12-Piece Ultimate Kit/ QWQJA07
Complies with the essential health and safety requirements of the
following directives:

2014/30/EU Electromagnetic Compatibility directive References to the
following harmonized standard were made:

EN55014-1: 2021

EN55014-2: 2021

EN IEC 61000-3-2:2019+A1:2021

EN 61000-3-3:2013+A2:2021

2011/65/EU+ (EU) 2015/863 Restrictions of the Use of Certain Hazardous
Substances in Electrical and Electronic Equipment
Authorised signatory and technical file holder:

Shanghai HOTO Technology Co., Ltd.
Building 45, No.50 Moganshan Road, Shanghai, China.

Manufacturer: Shanghai HOTO Technology Co., Ltd.

Address: Building 45, No.50 Moganshan Road, Shanghai, China

Designed by **HOTO**