

USER MANUAL



AIRTHEREAL

REVERSE OSMOSIS WATER PURIFIER

Pristine - Lite3

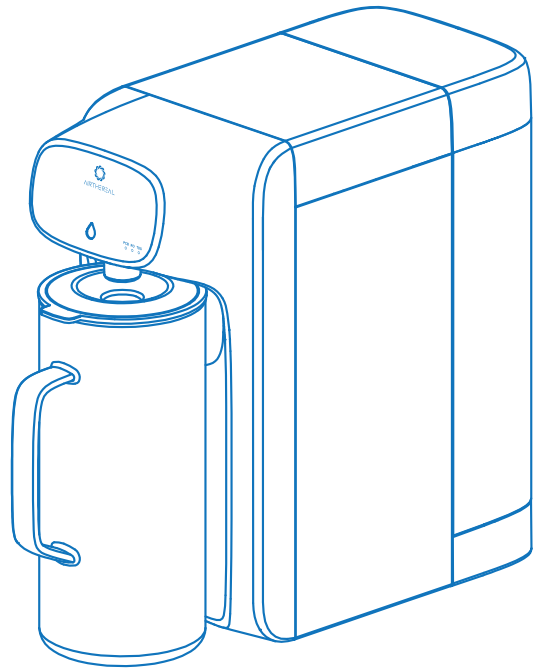

Please read this user manual in its entirety before use and keep it for future reference.

CONTENTS

SAFETY INSTRUCTIONS	02
SPECIFICATIONS	03
COMPONENTS	03
GETTING STARTED	04
MAINTENANCE	05
TROUBLESHOOTING	06
LIMITED WARRANTY	08



SAFETY INSTRUCTIONS

IMPORTANT SAFE GUARDS: To avoid the risk of serious injury when using your Reverse Osmosis Water Purifier, basic safety precautions must be followed, including but not limited to the following.

- All contents in this chapter are related to safety, users must comply with it.
- To protect against electric shock, do not place the power adapter, cord, base unit, or electronic module in water or other liquids.
- Keep out of reach of children. Do not let children operate the machine.
- Do not operate any appliance with a damaged electrical cord or plug or after the appliance malfunctions or has been dropped or damaged in any manner. If the power adapter cord is damaged, it must be replaced.
- Do not try to repair the machine yourself. If you have any problems, please contact Airthereal customer service for help.
- Use only factory-authorized replacement parts. The use of unauthorized replacement parts may degrade both the safety and the performance of this product and will void the limited warranty.
- The appliance must be dry before connecting to electrical power and be dry and free of leaks during operation.
- Avoid installing under direct sunlight and outdoor places.
- Do not expose this appliance to an environment below 32°F.
- Please make sure the temperature of the water source is 41-100°F.
- Do not store flammable items near the machine.
- When the machine will be inactive for more than 7 days, please empty the water tank and unplug the power supply.
- Regularly inspect product for water leaks as water leaks can cause property damage.
- Please only use accessories and filter cartridges from AIRTHEREAL.
- Unplug from the electrical outlet before cleaning or performing routine maintenance (i.e.replacing the filter cartridge).

SPECIFICATIONS

Product Name	Reverse Osmosis Water Purifier
Model	Lite3
Rated voltage	DC 24V
Rated Power	43W
Inlet Water Temperature	41-100°F
Working Pressure	0.4Mpa-0.8Mpa
Pure Water Rate	7 fl oz/min
Ambient Humidity	≤ 90%
Ambient Temp	39-104°F

COMPONENTS

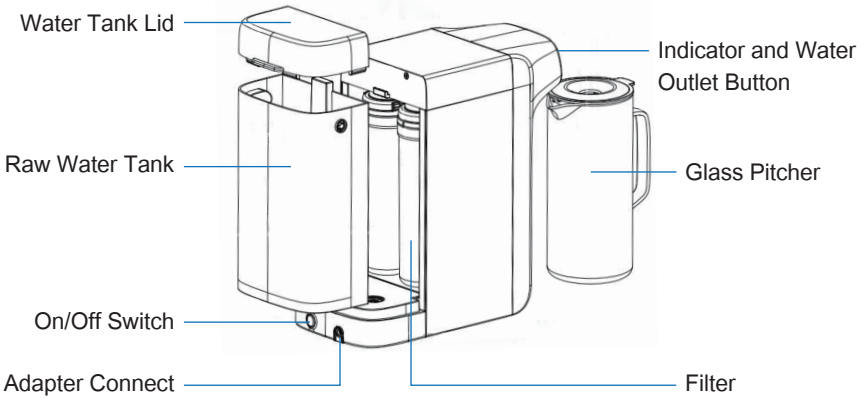





GETTING STARTED

Before First Use

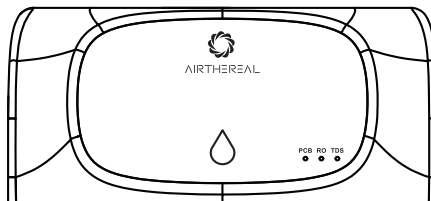
1. Please wash the water tank and glass pitcher before first use.
2. Fill the water to the MAX volume line on the water tank.
3. Place the machine on a flat and stable surface that is within reach of a power outlet.
4. Ensure the filter is installed securely in its designated spot. (The filter is preinstalled before delivery)
5. Plug into a power outlet and turn on the switch behind the machine. The display will illuminate.
6. Press the water button until the light turns red and starts blinking. Empty the glass pitcher and the water tank. This concludes one cycle of cleaning.
7. Repeat steps 2-6 in their entirety three times before using or drinking any water.

Function



Indicator	Operating Status	Display
	Short press to dispense water	White light blinking
	The water tank is not installed correctly or water needs to be added to the tank	Red light blinking
	Long press 3s to reset the filter	A 1-second beep will confirm the filter reset
	Need to replace the filter	Red light
	The real-time water quality indicator based on TDS (total dissolved solids)	Blue / Yellow / Red = Good / Fair / Poor

MAINTENANCE

Filter Lifespans

RO (Reverse Osmosis) Membrane Filter		need to replace the filter
PCB (Pleated PP Membrane & Activated Carbon Block) Filter		need to replace the filter

Note:

1. Filter lifespan is based on the power-on time of the whole machine or the time the machine is actively purifying water. Whichever time threshold is reached first will cause the filter reset indicator to illuminate.
2. The actual lifetime of the filters may differ depending on the input water quality, season, and how long the machine is powered on. The figures above are just an estimate. Your results may vary.

Filter Replacement

1. Turn off the power and remove the raw water tank.
2. Twist off the original filter in a counter-clockwise direction.
3. Insert the new filter and twist clockwise until tightened.
4. Press and hold the  icon for 3 seconds. The buzzer will beep for 1 second to alert that the filter has been reset successfully.

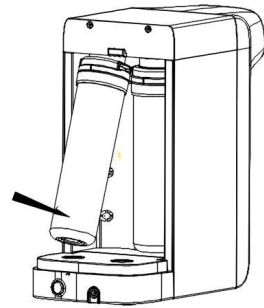
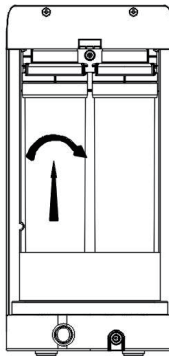
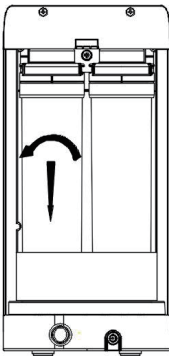

How to clean your water purifier

1. Please regularly wipe the exterior with a soft towel . Do not wipe the surface with chemical cleaners as not to damage the surface.
2. Do not rinse the product with water as it may cause water accumulation that is prone to bacteria and odors
3. Please clean the water tank regularly to keep the tank clean and hygienic. Dirty water in the tank may cause damage to seals and other components.
4. If you need to stop using this machine for a long time (more than 7 days), please drain the water tank and unplug from the power supply. When using the water purifier again, you must clean the unit according to the "Product Instructions" above before drinking.

TROUBLESHOOTING

Problem	Possible Causes	Solution
The machine does not work	Not plugged in to power	Check if the adapter power plug is loose
	The machine power switch is not on	Turn on the power switch on the rear of the machine
The machine does not make water	The original water tank is not installed in place	Check and install the raw water tank correctly
	The power supply is not plugged in	Ensure the power cord is plugged in correctly
	The water level in the tank is below the minimum water level line	Add water above the minimum water level line
The water tanks smells weird	The raw water tank needs to be cleaned	Wash the raw water tank regularly (recommended at least once a week)
	Water that has not been used for a long time or that has been stored in the internal tank for too long can have odors	Drain out the water and rinse thoroughly according to the cleaning instructions
	The filter needs to be replaced	Please purchase a new filter element and replace future filters when you see the change filter indicator illuminate

Problem	Possible Causes	Solution
The raw tank is leaking	The raw water tank is not installed in place	Check and reinstall the water tank to ensure it is secure
	The raw tank valve is stuck	Press the tank valve at the bottom with your finger
Water leakage	The filter element is not installed in place	Check that each filter is properly installed
	Other internal component failures	Remove from power and contact Airthereal for help
Water making becomes slow	The PCB filter is blocked	Replace the PCB filter
Abnormal sounds when dispensing water	The RO filter has exceeded its lifespan	Replace the RO filter
	The filter has expired	Replace the dirty filter
	Poor water quality leads to filter clogs	Replace the clogged filter
	Other causes	Remove from power and call Airthereal for help
There is dripping water on the tap	Damaged water seal or internal component failure	Turn off the power and call Airthereal for help
There is a misty white foam in the raw water tank	Air bubbles discharged by the reverse osmosis membrane	It is normal and may occur during water dispensing

LIMITED WARRANTY

We provide a 1-year warranty. For more information please visit:

www.airthereal.com/warranty

- **What's covered?**

Defects due to faulty materials and/or workmanship of the product.

- **What's not covered?**

1. Damage caused by the owner when attempting to fix or alter the product by himself or herself.
2. Damage caused by misuse, abuse, neglect, alterations, or unauthorized repair.
3. Natural depreciation.

- **Warranty Period**

Warranty becomes effective from the date of original purchase and will last for 1 year.

- **Who's covered?**

This limited warranty is only effective for the original purchaser. It is non-transferable.

- **How to request warranty services?**

To obtain the benefit of this warranty, please email support@airthereal.com.

Our customer service team will address your issue as soon as possible!

Always here to help you
www.airthereal.com

 **WARNING Cancer and Reproductive Harm**
www.p65warnings.ca.gov

Produced for: West Ryder Technology LLC
2330 Paseo Del Prado STE C304
Las Vegas, NV 89102

Made in China

V 202312

FOR THE AIR WE CARE