

Contents

1	Instructions	4
1.1	General safety instructions	4
1.2	Instructions for using microwaves	5
1.3	Manufacturer liability	7
1.4	Appliance purpose	7
1.5	Identification plate	7
1.6	Disposal	7
1.7	This user manual	8
1.8	How to read the user manual	8
2	Description	9
2.1	General Description	9
2.2	Control panel	10
2.3	Other parts	10
2.4	Microwaves	11
2.5	Available accessories	11
3	Use	12
3.1	Instructions	12
3.2	First use	13
3.3	Using the accessories	14
3.4	Using the oven	15
3.5	Cooking functions	17
3.6	Special functions	23
3.7	Secondary menu	27
4	Cleaning and maintenance	29
4.1	Instructions	29
4.2	Cleaning the surfaces	29
4.3	Ordinary daily cleaning	29
4.4	Food stains or residues	29
4.5	Cleaning the door glazing	30
4.6	Cleaning the inside of the oven	30
5	Installation	32
5.1	Electrical connection	32
5.2	Cable replacement	32
5.3	Positioning	33

We advise you to read this manual carefully, which contains all the instructions for maintaining the appliance's aesthetic and functional qualities.

For further information on the product: www.smeg.com



1 Instructions

IMPORTANT SAFETY INSTRUCTIONS

PLEASE READ CAREFULLY AND RETAIN FOR FUTURE USE.

1.1 General safety instructions

Risk of personal injury

- **WARNING:** If the door or the door seal is damaged, the oven must not be used until it has been repaired by a competent person.
- **WARNING:** It is hazardous for anyone other than a competent person to carry out any service or repair operation which involves the removal of a cover which offers protection against exposure to microwave energy.
- **WARNING:** Liquids and other foods must not be heated in sealed containers since they are liable to explode.
- **WARNING:** During use the appliance and its accessible parts become very hot.
- Never touch the heating elements during use.
- Keep children under eight years of age at a safe distance if they are not constantly supervised.
- This appliance may be used by children aged at least 8 and by people of reduced physical and mental capacity, or lacking in experience in the use of electrical appliances, as long they are supervised or instructed by adults who are responsible for their safety.
- Children must never play with the appliance.
- The appliance must never be cleaned by unsupervised children.
- Switch off the appliance immediately after use.
- If smoke is emitted, switch off or unplug the appliance and keep the door closed in order to stifle any flames.
- Never attempt to extinguish a flame or fire with water.
- Have qualified personnel carry out installation and assistance interventions according to the standards in force.
- Do not modify this appliance.
- Do not insert pointed metal objects (cutlery or utensils) into the slots in the appliance.
- Do not try to repair the appliance yourself or without the intervention of a qualified technician.
- If the power supply cable is damaged, contact technical support immediately and they will replace it.



Risk of damaging the appliance

- Do not use abrasive or corrosive detergents on glass parts (e.g. powder products, stain removers and metallic sponges).
- Use wooden or plastic utensils.
- Do not use a steam jet to clean the appliance.
- Do not obstruct ventilation openings and heat dispersal slots.
- Never leave the appliance unattended during cooking operations where fats or oils could be released.
- Do not use the appliance to heat rooms for any reason.
- Do not rest any weight or sit on the open door of the appliance.
- Take care that no objects are stuck in the doors.

1.2 Instructions for using microwaves

- Check the appliance visually during the cooking of foods in

plastic or paper containers.



Improper use Danger of explosion



- When using the microwave to heat or reheat liquids, the boiling process may be delayed – boiling temperature can be reached without the formation of the usual "rolling boil". This delayed boiling and consequent superheating of the liquid can generate an explosion inside the appliance, or sudden boiling over of the superheated liquid can occur when removing the container from the appliance. To avoid these dangers, it is necessary to insert the supplied boiling rod (or a heat-resistant plastic spoon) in the container while heating.
- Use the microwave only for the preparation of food for consumption. Other types of applications are strictly forbidden (e.g. drying clothes, warming slippers, sponges, wet cloths or the like, dehydrating foods) because they can lead to the risk of injury or fire.



Instructions

- Clean the appliance constantly and remove any food residue.
- Do not use the microwave to dry food.
- Do not use the microwave to heat oils or fry.
- Do not use the appliance to heat foods or beverages containing alcohol.
- Baby food should not be heated in sealed containers. Remove the cover or the teat (in the case of baby bottles). Always check the preparation's temperature once heating has completed, it should not be too high. For an even temperature and to avoid scalding stir or shake the contents.
- Do not heat eggs in their shells or whole hard boiled eggs; they may explode even after the heating process has completed.
- Before cooking food with a hard skin or peel (e.g. potatoes, apples, etc.) it is necessary to puncture the skin.
- Do not heat food contained within food packages.
- Do not use the microwave functions when the oven is empty.
- Use cookware and utensils that are suitable for use in a microwave oven.
- Do not use aluminium containers to cook food.
- Do not use dishes with metallic decorations (gold-plated or silver).
- The appliance operates in the 2.4GHz ISM band.
- In compliance with the provisions relating to electromagnetic compatibility the appliance belongs to group 2 and class B (EN 55011).
- This appliance complies with the standards and directives currently in force concerning safety and electromagnetic compatibility. It is however recommended for pacemaker wearers to maintain a minimum distance of 20-30cm between the microwave when it is operating and the pacemaker. Consult the pacemaker manufacturer for more information.



1.3 Manufacturer liability

The manufacturer declines all liability for damage to persons or property caused by:

- Use of the appliance other than the one envisaged;
- Non-observance of the user manual provisions;
- Tampering with any part of the appliance;
- Use of non-original spare parts.

1.4 Appliance purpose

- This appliance is intended for cooking food in the home environment. Every other use is considered inappropriate. It cannot be used:
 - in employee kitchens, shops, offices and other working environments.
 - in farms/agritourism establishments.
 - by guests in hotels, motels and residential environments.
 - in bed and breakfast establishments.
- The appliance is not designed to operate with external timers or with remote-control systems.

1.5 Identification plate

The identification plate bears the technical data, serial number and brand name of the appliance. Do not remove the identification plate for any reason.

1.6 Disposal



This appliance must be disposed of separately from other waste (Directives 2002/95/EC, 2002/96/EC, 2003/108/EC). The appliance does not contain substances in quantities sufficient to be considered hazardous to health and the environment, in accordance with current European directives.



Power voltage

Danger of electrocution

- Disconnect the main power supply.
- Disconnect the power cable from the electrical system.

To dispose of the appliance:

- Cut the power supply cable and remove it along with the plug (if present).
- Deliver the appliance to the appropriate recycling centre for electrical and electronic equipment waste, or return it to the retailer when purchasing an equivalent product, on a one for one basis.



Instructions

Our appliances are packed in non-polluting and recyclable materials.

- Deliver the packing materials to the appropriate recycling centre.



Plastic packaging Danger of suffocation

- Do not leave the packaging or any part of it unattended.
- Do not let children play with the packaging plastic bags.

1.7 This user manual

This user manual is an integral part of the appliance and must therefore be kept in its entirety and within the user's reach for the whole working life of the appliance.

- Read this user manual carefully before using the appliance.

1.8 How to read the user manual

This user manual uses the following reading conventions:

Instructions



General information on this user manual, on safety and final disposal.

Description



Description of the appliance and its accessories.

Use



Information on the use of the appliance and its accessories, cooking advice.

Cleaning and maintenance



Information for proper cleaning and maintenance of the appliance.

Installation



Information for the qualified technician: Installation, operation and inspection.



Safety instructions



Information



Advice

1. Sequence of instructions for use.

- Standalone instruction.



2 Description

2.1 General Description

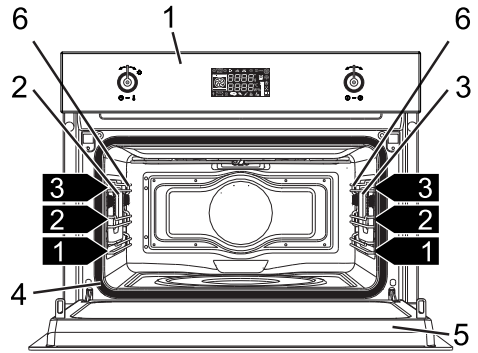
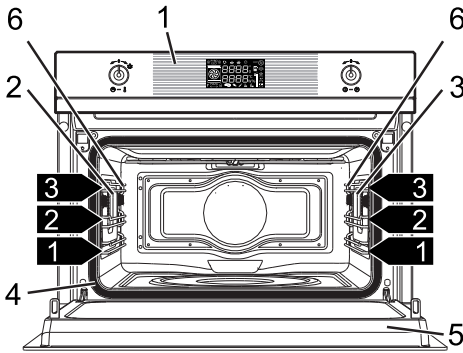

- 1 Control panel
- 2 LH Light bulb
- 3 RH Light bulb (on some models only)
- 4 Seal
- 5 Door
- 6 Rack/tray support frames

1,2,3... Frame shelf

EN



Description

2.2 Control panel

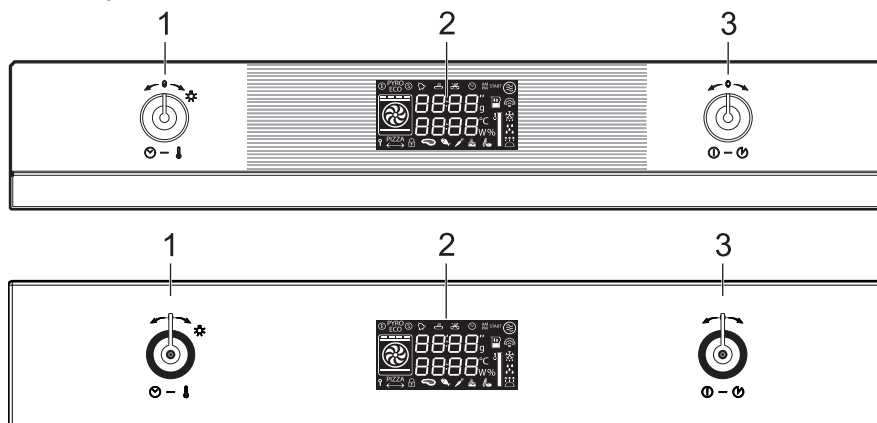

Temperature knob (1)

This knob is used to select:

- Microwave power level
- Cooking temperature
- Function's duration
- Programmed cooking procedures
- Current time
- Switching on or off of the appliance internal lamp.

Display (2)

Displays the current time, the selected cooking function, power and temperature and any time set.

Function knob (3)

This knob can be used to:

- Turn the appliance on and off
- Select a function
- Temporarily start or stop a function.

2.3 Other parts

Shelves

The appliance features shelves to position trays and racks at different heights. The insertion heights are indicated from the bottom upwards (see 1.10 General Description).

Cooling fan

The fan cools the oven and comes into operation during cooking.

The fan causes a steady outflow of air from above the door which may continue for a brief period of time even after the appliance has been turned off.

Interior lighting

The oven light comes on when the door is opened or any function is selected. To save energy, the lamp will remain on for one minute at the beginning of each cooking cycle (this feature can be disabled through the secondary menu).

Turn the temperature knob briefly to the right to activate or deactivate internal lighting.



2.4 Microwaves

The appliance is equipped with a microwave generator called a magnetron. The microwaves generated are evenly emitted into the oven compartment in order to reach the food and heat it.

Heating takes place through the process of friction between the molecules contained within the food (mainly water molecules), with the consequent generation of heat.

The heat generated directly inside the food leads to defrosting, re-heating or cooking in a shorter length of time compared to traditional cooking.

The use of suitable containers for microwave cooking allows the microwaves to reach the food in a uniform manner (see Materials suitable for microwaves).

2.5 Available accessories



Some models are not provided with all accessories.

Rack

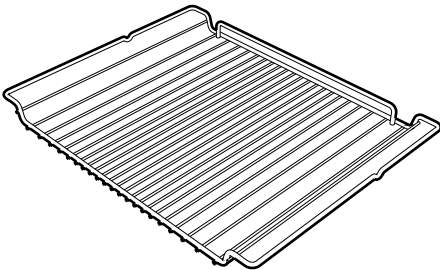

Useful for supporting containers with food during cooking.

Baker Plate

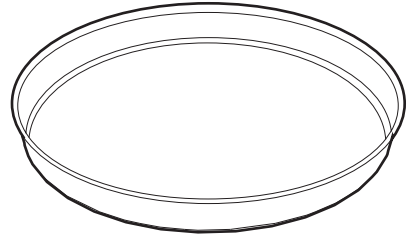

Good for browning foods evenly.

Boiling Rod



To be placed in containers when heating liquids, necessary to avoid delayed boiling with resulting superheating.



The oven accessories intended to come into contact with food are made of materials that comply with the provisions of current legislation.



Original supplied and optional accessories can be requested to Authorised Assistance Centres. Use only original accessories supplied by the manufacturer.



3 Use

3.1 Instructions



High temperature inside the oven during use
Danger of burns

- Keep the oven door closed during cooking.
- Protect your hands wearing heat resistant gloves when moving food inside the oven.
- Do not touch the heating elements inside the oven.
- Do not pour water directly onto very hot trays.
- Do not allow children to get near the oven when it is in operation.



High temperature inside the oven during use
Danger of fire or explosion

- Do not spray any spray products near the oven.
- Do not use or leave flammable materials near the oven.
- Do not use plastic kitchenware to cook food (except with the microwave function).
- Do not put sealed tins or containers in the oven.
- Do not leave the oven unattended during cooking operations where fats or oils could be released.
- Remove all trays and racks which are not required during cooking.



Improper use
Risk of damage to enamelled surfaces

- Do not cover the bottom of the oven cavity with aluminium or tin foil sheets.
- If you wish to use greaseproof paper, place it so that it will not interfere with the hot air circulation inside the oven.
- Do not bang or drag cookware over the glazed bottom of the oven compartment.
- Do not pour water directly onto very hot trays.

Materials suitable for microwaves

In general, in order for the food to be reached, the materials used for microwave cooking must be transparent to microwave energy.

Below is a table of materials to use and those not to use:

MATERIALS TO USE:

Glass*

- Baking ware
- Glasses
- Glass jars

Always remove the covers.

Porcelain

Ceramic

Plastic*

- Containers
- Plastic wrap

Only where suitable for microwave use.

Where film is used it must not come into contact with the food.

* only if heat-resistant



NOT TO BE USED

Metal

- Aluminium foil
- Aluminium trays
- Plates
- Metal utensils
- Freezer bags tie wraps

These can lead to arcing or sparks.

Wood

Crystal glasses

Paper

Risk of fire.

Expanded polystyrene containers

Risk of food contamination.

*only if heat-resistant



Dishes must be without metal decorations.



Do not use metal accessory trays in the microwave or combined microwave functions.

Testing dishes



The microwave function can be used without any food inside the oven only for this test.

To check whether or not cookware is suitable for use with microwave cooking carry out this simple test:

1. Remove all accessories from the oven compartment.
2. Place the cookware to be tested into the oven compartment.
3. Select the maximum power level (e.g. 1000W).

4. Set a cooking time of 30 seconds.
5. Start cooking.



Unsuitable cookware

Risk of damages to the appliance

- If there is crackling or if sparks are emitted from the cookware then immediately terminate the test. In this instance the cookware is not suitable for microwave cooking.
6. At the end of the test the cookware must be either cold or slightly warm. If the cookware is hot then it should be considered as unsuitable for microwave use.

3.2 First use

1. Remove any protective film from the outside or inside of the appliance, including accessories.
2. Remove any labels (apart from the technical data plate) from the accessories and from the oven cavity.
3. Remove and wash all the appliance accessories (see 3 Cleaning and maintenance).
4. Heat the empty oven at maximum temperature (using the traditional functions) so as to remove any manufacturing residues.



For the first heating use a traditional function and not a microwave function.



3.3 Using the accessories

Racks and trays

Racks and trays have to be inserted into the side guides until they come to a complete stop.

- The mechanical safety locks that prevent the rack from being taken out accidentally have to face downwards and towards the oven back.

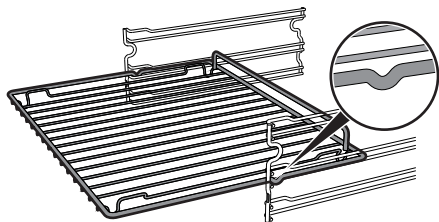

Baker Plate

The Baker plate must be placed in the centre of the rack for perfect operation.

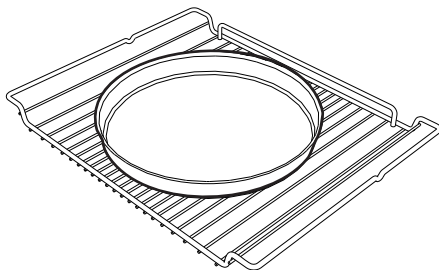

**High temperature
Danger of burns**

- The accessory gets very hot. Always use oven gloves when handling.



**High temperature
Danger of burns**

- The accessory gets very hot. Always use oven gloves when handling.



**Improper use
Risk of damage to surfaces**

- Do not use knives directly on the surface of the plate
- When cleaning, do not use metal sponges or scourers which could damage the surface.



Gently insert racks and trays into the oven until they come to a stop.



Clean the trays before using them for the first time to remove any residues left by the manufacturing process.



Boiling Rod

When using the microwave to heat or reheat liquids, the boiling process may be delayed. To avoid this dangerous phenomenon, it is necessary to insert the supplied boiling rod (or a heat-resistant plastic spoon) in the container while heating.



Improper use Danger of explosion/burns

- To avoid the danger of explosion inside the appliance or the sudden boiling over of superheated liquids, it is always necessary to immerse the boiling rod in the liquid being heated.



High temperature Risk of damage to the accessory

- Use the boiling rod only with Microwave functions. The rod must not be used with combined and traditional functions.

3.4 Using the oven

Display

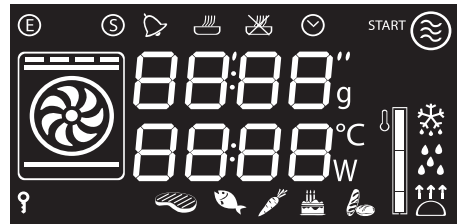

- Clock indicator light
- Minute minder timer indicator light
- Timed cooking with delayed start indicator light
- Timed cooking indicator light
- Child lock indicator light
- Showroom indicator light
- Eco logic indicator light
- Microwave indicator light
- Temperature level reached



Use

Operating modes

Stand-by: When no function is selected, the display shows the current time and the symbol .



ON: When any function starts the display shows the current settings such as temperature, duration, microwave power level and the temperature level reached.

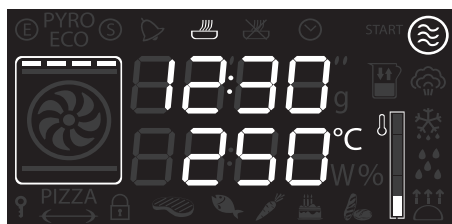

Each time the temperature knob is pressed during the operation of a function the parameters will be cycled through in the following order.

For each parameter the setting can be altered by turning the temperature knob to the right or left. Keep the knob turned to produce a faster increase or decrease.

If a microwave function is selected:



1. Microwave power level.
2. Function duration.

If a Microwave+Grill function is selected:



1. Temperature.
2. Function duration.
3. Microwave power level.

If a Grill function is selected:



1. Temperature
2. Minute minder timer duration.
3. Function duration.
4. Programmed cooking duration (if timed cooking has been selected).
5. Time display.



Setting the time

On the first use, or after a power failure, **00:00** will be flashing on the appliance's display. To be able to start any cooking function, the current time must be set.

1. Turn the temperature knob to set the hour displayed (to increase or decrease more quickly keep the knob turned to the right or left).
2. Press the temperature knob.
3. Turn the temperature knob to set the minutes displayed (to increase or decrease more quickly keep the knob turned to the right or left).
4. To confirm the settings press the temperature knob.



It may become necessary to change the current time, for example for daylight saving time. From stand-by mode keep the temperature knob turned to the right or left until the hour value flashes.

It is not possible to change the time if the oven is **ON**.

3.5 Cooking functions



For microwave cooking, the food must be placed in a container on the rack on the first shelf.

IT IS NOT RECOMMENDED TO COOK FOOD IN A CONTAINER RESTING ON THE BOTTOM OF THE COOKING COMPARTMENT.

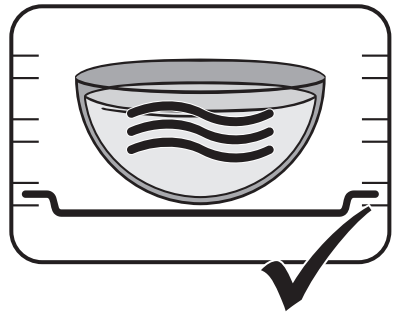
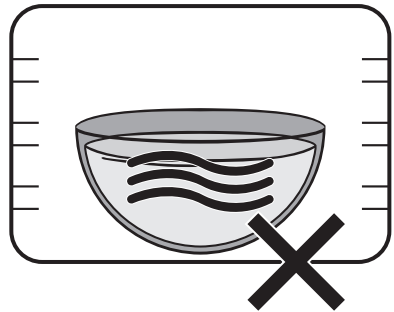



For best results, with prolonged microwave and combined cooking, it is best to stir foods once or twice.

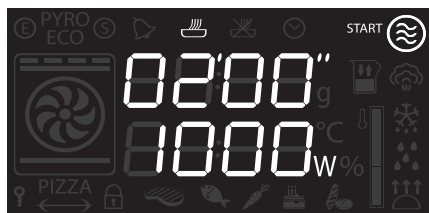

Use

Microwave:



1. Select the microwave function  using the function knob.
2. Press the temperature knob.
3. Turn the temperature knob to change the cooking time (max 30 minutes).
4. Press the temperature knob.
5. Turn the temperature knob to change the power level from 100W to 1000W (see Microwave power levels).
6. Press the function knob to start microwave cooking.

7. At the end of the cooking time the display will indicate the word Stop.



Turn the temperature knob to set an additional cooking time.

Press the function knob to start cooking.



To turn off the appliance press and hold the function knob.



Microwaves

Given that they penetrate directly into the food, microwaves allow cooking to take place in a very short period of time and with a considerable saving of energy. They are suitable for cooking without fat and also for defrosting and re-heating food while maintaining its original appearance and fragrance.



If the door is opened then cooking will stop. Once the door is closed press the function knob to resume cooking.



Press the function knob to temporarily stop the cooking function. Press it again to resume cooking.





Microwave power levels

Below is a list of the power levels that can be selected:

Power (W)	Useful for
100	Defrosting food
200	
300	
400	Cooking meat or delicate cooking
500	
600	Re-heating and cooking food
700	
800	
900	
1000	Heating liquids

QUICK START microwave function

i The QUICK START function allows the microwave to be started quickly. This is useful for heating small quantities of liquid or food.

1. From stand-by mode press the function knob twice.



2. The appliance will start the microwave oven with the default settings.

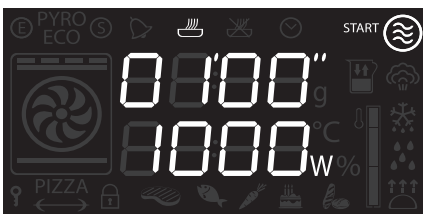

Combination Microwave + grill function

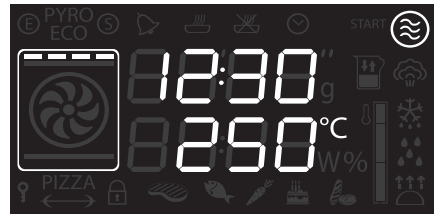

i Combination cooking is a mix of traditional cooking and microwave operation.



Microwave + Grill

The use of the grill results in perfect browning of the food's surface.



Using the microwave on the other hand leads to rapid internal cooking of the food.

1. Select the Microwave+Grill function with the function knob.
2. Press the temperature knob.
3. Turn the knob to set the temperature.
4. Press the temperature knob.
5. Turn the temperature knob to change the cooking time.
6. Press the temperature knob.
7. Turn the temperature knob to change the power level (from 100W to 700W).
8. Press the function knob to start combination cooking.



Improper use

Risk of damages to the appliance

- Do not use the combined functions to heat or boil liquids.



Grill Function

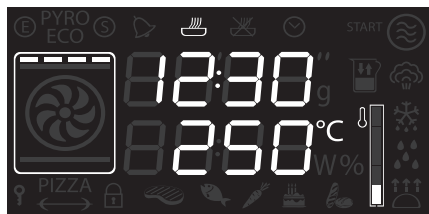

Grill

The heat coming from the grill element gives perfect grilling results above all for thin and medium thickness meat and allows you to give the food an even browning at the end of the cooking. Perfect for sausages, spare ribs and bacon. This function enables large quantities of food, particularly meat, to be grilled evenly.

1. Select the Grill function with the function knob.
2. Press the temperature knob.
3. Turn the knob to set the temperature.
4. Press the function knob to start combination cooking.

Pre-heating stage

In the grill function, cooking itself is preceded by a preheating stage, which allows the oven to heat to the cooking temperature more quickly.

This stage is indicated by the flashing of the temperature level reached indicator.

At the end of the preheating stage the temperature level reached indicator remains on and a buzzer sounds to indicate that food can be placed into the oven.



Cooking can be stopped at any time by pressing and holding the function knob for at least 3 seconds.

Minute minder



This function only activates the buzzer, without stopping cooking.



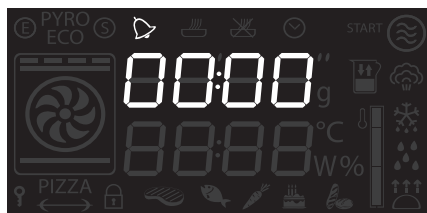

The minute minder can be activated both during cooking and when the appliance is in standby.

1. Press the temperature knob once (twice if cooking is already in progress). The display shows **00:00** and the indicator flashes.





- Turn the temperature knob to set the duration (from 1 minute to 4 hours). After a few seconds, the  indicator light stops flashing and the countdown starts.
- Select the grill function and wait for the buzzer to sound, indicating that the cooking time is over. The  indicator light flashes.
- Turn the knob to select an additional minute minder. Or else press the temperature knob to stop the buzzer.

Keep the knob turned to produce a faster increase or decrease.

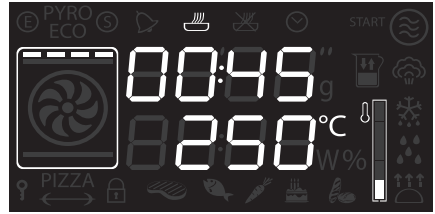

- A few seconds after the required duration is set, the  indicator light stops flashing and timed cooking starts.
- At the end of the cooking time STOP appears on the display and a buzzer will sound that can be deactivated by pressing the temperature knob.

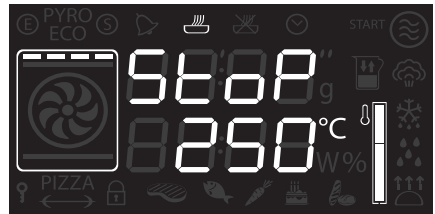

Timed cooking (only for grill function)

i Timed cooking is the function which allows a cooking operation to be started and then ended after a specific length of time set by the user.

i Activation of timed cooking cancels any minute minder timer which may previously have been set.

- After selecting a cooking function and temperature, press the temperature knob three times. The display shows **00:00** and the  indicator light flashes.

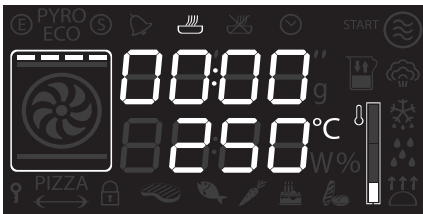

- Turn the temperature knob to set the cooking time (from 00:01 a 12:59).

 To select an additional timed cooking period turn the temperature knob to the right or left.

 To extend the cooking time manually, press the temperature knob again. The appliance will resume its normal operation with the previously selected cooking settings.

 To turn off the appliance press and hold the function knob.



Use

Programmed cooking (only for grill function)

i Timed cooking is the function which allows a cooking operation to be started and then ended after a specific length of time set by the user.

i Activation of timed cooking cancels any minute minder timer which may previously have been set.

i Programmed cooking refers to the function that allows cooking to be stopped automatically at a time set by the user followed by the oven automatically turning itself off.

1. After selecting a cooking function and temperature, press the temperature knob three times. The display shows **00:00** and the indicator light flashes.

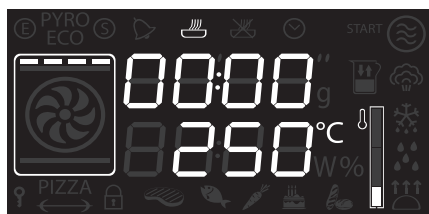

2. Turn the knob to set the cooking time (from 00:01 a 12:59). Keep the knob turned to produce a faster increase or decrease.

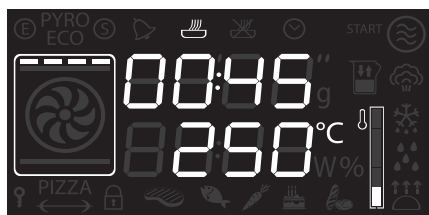

3. Press the temperature knob a fourth time. The indicator light flashes. Turn the knob to set the cooking end time.
4. After a few seconds the and indicator lights stop flashing. The appliance waits for the set start time.



5. When cooking has completed the word STOP appears on the display and a buzzer sounds which can be deactivated by pressing the temperature knob.

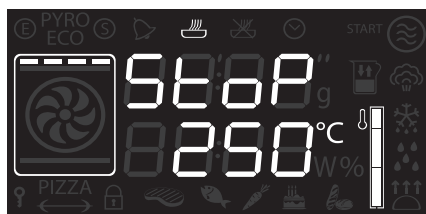

To extend the cooking time manually, press the temperature knob again. The appliance will resume its normal operation with the previously selected cooking settings.

To turn off the appliance press and hold the function knob.

i For safety reasons, it is not possible to set the end of cooking time by itself without setting the cooking duration.



3.6 Special functions

Heating

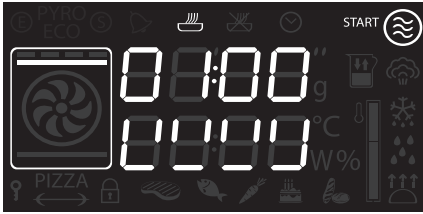

i This function is for microwave re-heating of food that has been previously cooked and stored in the refrigerator.

1. Press the function knob to select the re-heating function.
2. Press the temperature knob.
3. Turn the temperature knob to change the re-heating time.
4. Press the function knob to confirm the settings and start re-heating.

Baker

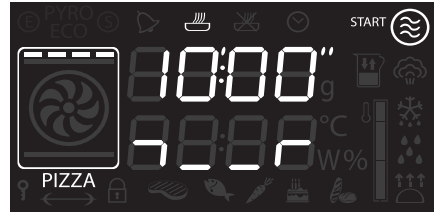

i This function provides food with a golden, crunchy texture by using the Baker plate. Ideal for pizzas, oven chips and pies.

1. Position the rack on the required level. Place the empty Baker plate in the centre.

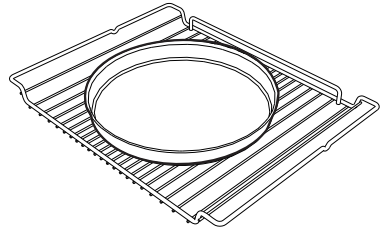

2. Press the function knob to select the Baker function.
3. Press the temperature knob.
4. Turn the temperature knob to set the heating duration (from 10 minutes to 99 minutes).



Use

- Press the function knob to confirm the parameters and start preheating the Baker plate without food.



- When preheating has finished, the appliance will wait for food to be inserted.



- Position the food inside the Baker plate.

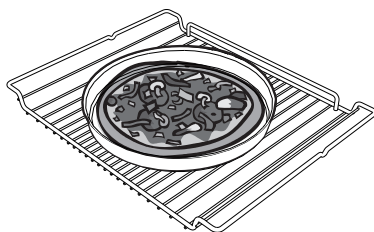

Improper use Risk of damages to the appliance

- Do not position recipients on the Baker plate if they are not heat proof.

- Press the function knob to restart cooking.
- On completion the word Stop will be displayed.

Cooking suggestions table :

Type	Weight (g)	Shelf	Time (min)
Frozen pizza	300	2	11
Fresh pizza	600	2	14
Frozen Oven Chips	500	2	15
Frozen chicken nuggets	500	2	16
Fresh beaten eggs	400	2	9



High temperature Danger of burns

- Use oven gloves when handling the Baker plate





The indicated time includes the time for preheating the empty Baker plate.

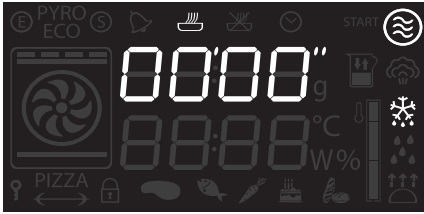

Timed defrosting



This function allows food to be defrosted by the microwave according to a selected period of time.

1. Place the dish into the oven compartment (see "Turn" procedure).
2. Use the function knob to select timed defrosting as indicated by the  and  symbols.
3. Press the temperature knob to change the defrosting time.
4. Turn the knob to set the defrosting time (from 5 minute up to 99 hours).
5. Press the function knob to start defrosting.



If the selected defrost duration is more than 5 minutes then, for best results, the dish inside the oven compartment will need to be turned. See: "Turn" procedure.

6. On completion the word Stop will be displayed.

Weight based defrosting

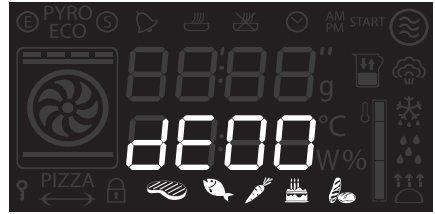

This function allows food to be microwave defrosted according to the weight and type of food to be defrosted.

1. Place the dish into the oven compartment (see "Turn" procedure).
2. Use the function knob to select weight based defrosting indicated by "dE00" and lit up dish symbols.
3. Turn the function knob to select the type of food to be defrosted.
4. Turn the temperature knob to select the weight (in grams) of the food to be defrosted.
5. Press the function knob to confirm the settings and start defrosting.







For best results during defrosting the dish inside the oven will need to be turned. See: "Turn" procedure.

6. On completion the word Stop will be displayed.



Use

Pre-set parameters:

dE	Type	Weight (g)	Time (min)
01	 Meat	500	20
02	 Fish	400	17
03	 Fruit	300	15
04	 Bread	300	5

"Turn" procedure

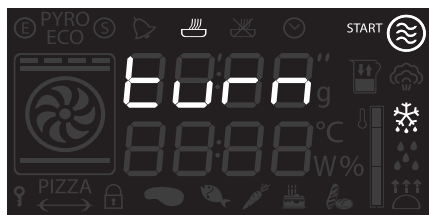

For best defrosting results it is recommended, when necessary, to turn the dish inside the oven compartment.

1. Put the dish in the oven placing it parallel to the door.

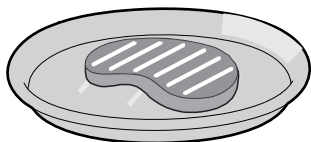

2. When the word "Turn" is displayed it is necessary to turn the dish.
3. Open the door and turn the dish 90°.

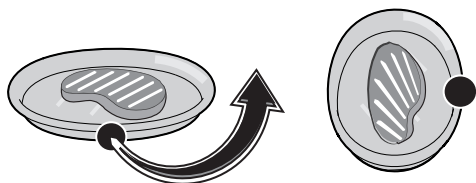

i If dish rotation is not performed the appliance will wait for one minute and then automatically continue defrosting. As a reminder the word "Turn" will remain displayed beneath the countdown indication.

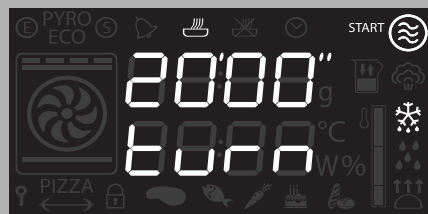

4. Close the door and press the function knob to resume operation.
5. If necessary the appliance will again ask for rotation of the dish. The word "Turn" will be displayed.
6. For the second rotation the door will need to be opened and the dish turned by 180°.

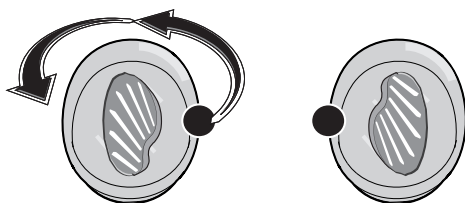

7. Close the door and press the function knob to resume operation.



3.7 Secondary menu

The appliance also has a drop-down secondary menu allowing the user to:

- Activate or deactivate the Child Lock.
- Activate or deactivate Showroom mode (which disables all the heating elements so that only the control panel works).
- Activate or deactivate Low Power mode (Eco-Logic).
- (some models only) Activate or deactivate Keep Warm mode.
- Activate or deactivate internal light timed mode (Eco-Light).

With the appliance in Stand-By mode

1. Activate the internal light by turning the temperature knob quickly.
2. Press and hold the temperature knob down for at least 5 seconds.
3. Turn the temperature knob right or left to change the setting status (ON/OFF).
4. Press the temperature knob to move to the next mode.

Child Lock mode: This mode allows the appliance to lock the controls automatically after one minute of normal operation without any intervention from the user.

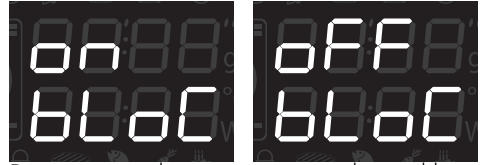

During normal operation it is indicated by the  indicator light coming on.

To release the lock temporarily during cooking, hold the temperature knob down for 5 seconds. One minute after the last setting the lock will become active again.



Touching or varying the position of the temperature and function knobs, the display will show "bloc" for two seconds.



Even with the child lock mode activated the appliance can be turned off instantly by pressing the function knob for 3 seconds.



Use

Showroom mode (for exhibitors only):

This mode allows the appliance to deactivate all heating elements, while keeping the control panel active.



To use the appliance normally, set this mode to OFF.

Keep Warm Mode (some models only):

In this mode, at the conclusion of the cooking cycle for which a duration was set (if not stopped manually), the appliance keeps freshly cooked food warm (at low temperatures) for around 1 hour.



Internal lamp timed mode

For energy saving the internal lamp is switched off automatically one minute after cooking begins.

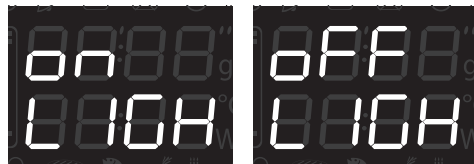

To prevent the appliance from automatically turning the internal lamp off turn this mode to OFF.

Low Power mode: This mode allows the appliance to limit the power used. Suitable for simultaneous use with further home appliances.



HI: normal power.

LO: low power.



Activating low power mode means that preheating and cooking times may be extended.



If the mode is active, the **E** indicator light lights up on the display.



With both settings the manual on/off control is always available by turning the temperature knob to the right.



4 Cleaning and maintenance

4.1 Instructions



High temperatures inside the oven after use
Danger of burns

- Perform cleaning only after letting the appliance cool down.



Improper use
Risk of damage to surfaces

- Do not use a steam jet to clean the appliance.
- Do not use cleaning products containing chlorine, ammonia or bleach on steel parts or parts with metallic finishes on the surface (e.g. anodizing, nickel- or chromium-plating).
- Do not use abrasive or corrosive detergents on glass parts (e.g. powder products, stain removers and metallic sponges).
- Do not use rough or abrasive materials or sharp metal scrapers.
- Failure to clean the oven could adversely affect the life of the appliance and pose a hazard.
- Always remove food residues from the oven compartment.



Improper use
Danger of explosion/burns

- Do not use detergents with high alcohol content or which can release inflammable vapours. Subsequent heating could set off an explosion inside the appliance.



If a lamp is damaged contact Technical support for a replacement. This fault will not affect the integrity of the appliance which can continue to be used.

4.2 Cleaning the surfaces

To keep the surfaces in good condition, they should be cleaned regularly after use. Let them cool first.

4.3 Ordinary daily cleaning

Always use only specific products that do not contain abrasives or chlorine-based acids.

Pour the product onto a damp cloth and wipe the surface, rinse thoroughly and dry with a soft cloth or a microfibre cloth.

4.4 Food stains or residues

Do not use metallic sponges or sharp scrapers as they will damage the surfaces.

Use ordinary non-abrasive products with the aid of wooden or plastic utensils if necessary. Rinse thoroughly and dry with a soft cloth or a microfibre cloth.

Do not allow residues of sugary foods (such as jam) to set inside the oven. If left to set for too long, they might damage the enamel lining of the oven.

4.5 Drying

Cooking food raises the humidity inside the cooking compartment. This is a perfectly normal phenomenon that does not compromise the correct operation of the appliance.

At the end of each cooking session:

1. Allow the appliance to cool down
2. Wipe down the cooking compartment



Cleaning and maintenance

3. Dry the cooking compartment with a soft cloth
4. Leave the door open as long as necessary to ensure that the cooking compartment dries completely.

4.6 Cleaning the door glazing

The glass in the door should always be kept thoroughly clean. Use absorbent kitchen roll. In case of stubborn dirt, wash with a damp sponge and an ordinary detergent.



We recommend the use of cleaning products distributed by the manufacturer.

4.7 Cleaning the inside of the oven

For the best oven upkeep, clean it regularly after having allowed it to cool.

Take out all removable parts.

Clean the oven racks with warm water and non-abrasive detergent. Carefully rinse and dry damp parts.

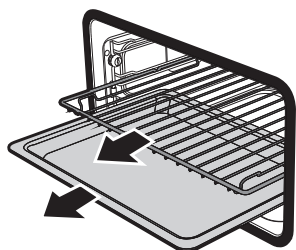

The oven should be operated at the maximum temperature for about 15-20 minutes after the use of specific products, to burn off the residues left inside the oven.



For easier cleaning, remove the door.

Removing racks/trays support frames

Removing the guide frames enables the sides to be cleaned more easily. This operation should be performed each time the automatic cleaning cycle is used (on some models only).

To remove the guide frames:

1. Unscrew the two fastening pins of the frame

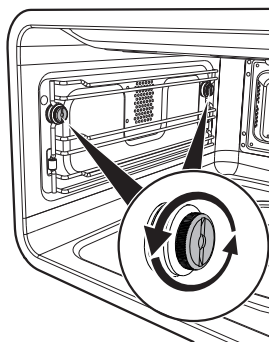

2. Pull the frame towards the inside of the oven.

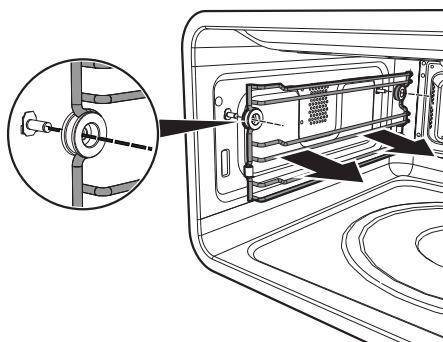

3. When cleaning is complete, repeat the above procedures to put the guide frames back in. Pay attention to the spacer bushings which need to be inserted correctly into the frames.



Cleaning the top of the compartment

The appliance is equipped with a tilting grill element that allows for easy cleaning of the upper part of the oven compartment.

1. Free the upper heating element by gently lifting it and rotating its retaining latch by 90 degrees.

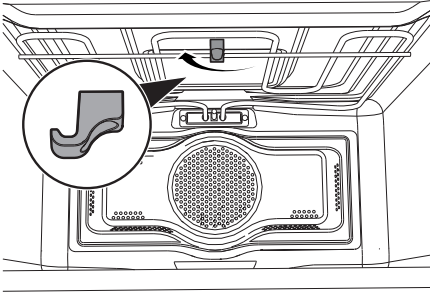

2. Gently lower the heating element until it stops.

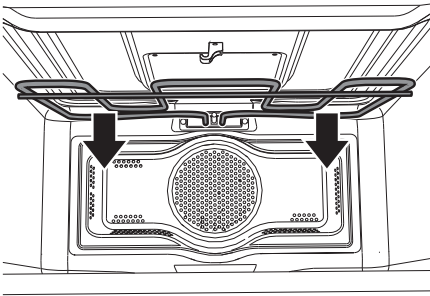

Improper use
Risk of damages to the appliance

- Do not excessively flex the element during cleaning.

3. When you have finished cleaning, place the heating element back in position and turn the retaining latch to lock it in place.

What to do if...

The display is completely off:

- Check the mains power supply.
- Check whether an omnipolar switch upstream of the appliance supply line is in the "ON" position.

The appliance does not heat up:

- Check whether it has been set in "showroom" mode (for further details see 2.7 Secondary menu).

The controls do not respond:

- Check whether it has been set in "child lock" mode (for further details see "Secondary menu").

The cooking times are longer than those indicated in the table:

- Check whether it has been set in "low power" mode (for further details see "Secondary menu").



If the problem has not been resolved or in the case of other types of fault, contact your local technical support centre.



If other ERRx error messages are indicated:

Note down the error message, function and set temperature and contact your local technical support centre.



5 Installation

5.1 Electrical connection



Power voltage
Danger of electrocution

- Have the electrical connection performed by authorised technical personnel.
- The appliance must be connected to earth in compliance with electrical system safety standards.
- Disconnect the main power supply.

General information

Check the grid characteristics against the data indicated on the plate.

The identification plate bearing the technical data, serial number and brand name is visibly positioned on the appliance.

Do not remove this plate for any reason.

The appliance works at 220-240 V~.

Use a H05V2V2-F type three-core cable (3 x 1.5 mm² cable, referring to the cross section of the internal conductor).

Perform the ground connection using a wire that is 20 mm longer than the other wires.

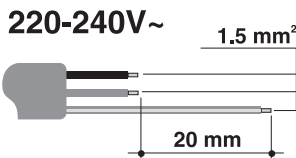

Fixed connection

Fit the power line with an omnipolar circuit breaker in compliance with installation regulations.

The circuit breaker should be located near the appliance and in an easily reachable position.

Connection with plug and socket

Make sure that the plug and socket are of the same type.

Avoid using adapters and shunts as these could cause overheating and a risk of burns.

5.2 Cable replacement



Power voltage
Danger of electrocution

- Disconnect the main power supply.

1. Unscrew the rear casing screws and remove the casing to access the terminal board.
2. Replace the cable.
3. Make sure that the cables (for the oven or any hob) follow the best route in order to avoid any contact with the appliance.



5.3 Positioning



**Heavy appliance
Danger of crush injuries**

- Place the appliance into the piece of furniture with the aid of a second person.



**Pressure on the open door
Risk of damages to the appliance**

- Never use the oven door to lever the appliance into place when fitting.
- Avoid exerting too much pressure on the oven door when open.



**Heat production during appliance operation
Risk of fire**

- Check that the piece of furniture material is heat resistant.
- Check that the piece of furniture has the required slots.
- Do not install the appliance in a recess which can be closed with a door, or in a cupboard.

Secure the appliance to the piece of furniture using screws.

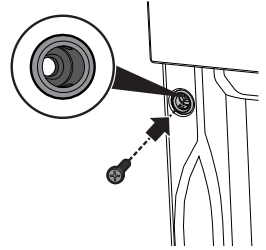

Cover the bushings with the covers removed previously.

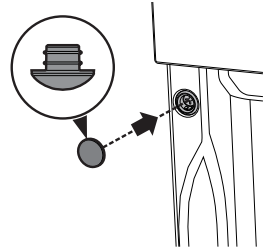

Appliance overall dimensions (mm)

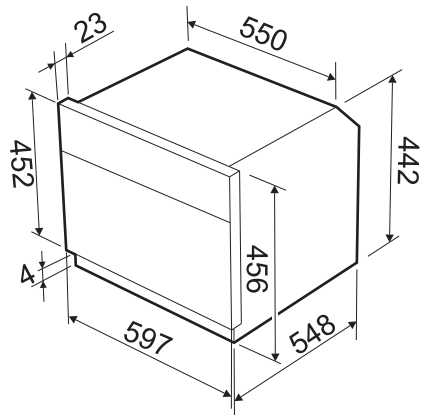

Fastening bushings

Remove the bushing covers inserted on the oven front.
Mount the appliance into the recess.

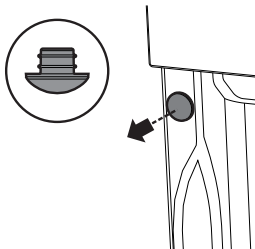



Installation

Mounting under worktops (mm)

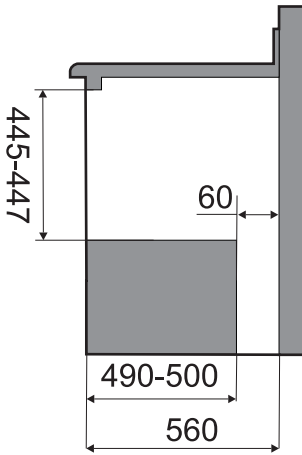
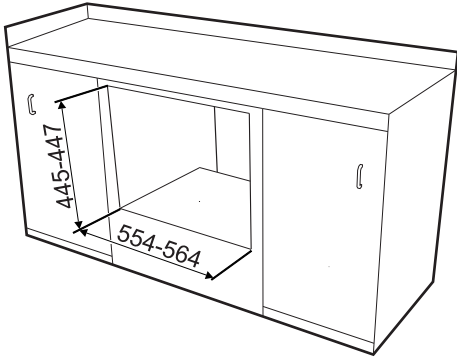

Mounting into a column (mm)

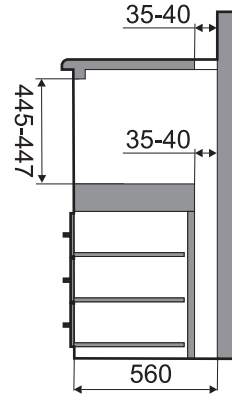
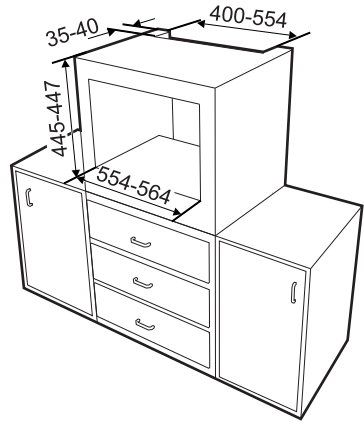

Make sure that the piece of furniture rear/bottom part has an opening of approx. 60 mm.



Make sure that the piece of furniture top/rear part has an opening approx. 35-40 mm deep.



914776111/B