

OPERATOR'S MANUAL MANUAL DEL USUARIO

CRAFTSMAN®

24V MAX* LITHIUM-ION CORDLESS POLE SAW

PODADORA DE ALTURA INALÁMBRICA CON BATERÍA DE IONES DE LITIO DE 24 V MÁX.*

Model No. 151.74326
(INCLUDES battery & charger)

Modelo n° 151.74326
(INCLUYE batería y cargador)

Model No. 151.74926
(Battery & charger NOT INCLUDED)

Modelo n° 151.74926
(Batería y cargador NO INCLUIDOS)

**NOTE: BAR & CHAIN OIL NOT
INCLUDED. BAR & CHAIN OIL
MUST BE ADDED PRIOR TO USE.**

**NOTA: ACEITE PARA BARRA
Y CADENA NO INCLUIDO. SE
DEBE AÑADIR ACEITE PARA
BARRA Y CADENA ANTES
DE USAR.**

⚠ CAUTION: To reduce the risk of injury, the user must read and understand the operator's manual before using this product.

⚠ PRECAUCIÓN: Para reducir el riesgo de lesiones, el usuario debe leer y comprender el manual antes de utilizar este producto.



Sears Brands Management Corporation, Hoffman Estates, IL 60179 USA

Visit the Craftsman web page: www.craftsman.com

Visite el sitio Web de Craftsman: www.craftsman.com

**Save this manual for future reference
Conserve este manual para futura referencia.**

* Maximum initial battery voltage (measured without workload) is 24 volts.
Nominal working voltage is 21.6 volts.

* La tensión inicial máxima de la batería (medida sin carga) es 24 voltios.
La tensión de trabajo nominal es 21,6 volts.



TABLE OF CONTENTS / TABLA DE CONTENIDOS

ENGLISH

■ Warranty	2
■ Introduction	2
■ General Safety Instructions	3-4
■ Specific Safety Instructions	5-7
■ Symbols	8-9
■ Features	10
■ Assembly	11-12
■ Battery Pack and Charger	13-14
■ Operation	15-19
■ Care and Maintenance	20-24
■ Environmentally Safe Battery Disposal	25
■ Troubleshooting	26
■ Illustrated Parts List	27-28
■ Figure Numbers (Illustrations)	i-xi

ESPAÑOL

■ Garantía	Sección de Inglés pág. 2
■ Introducción	Sección de Inglés pág. 2
■ Instrucciones generales de seguridad	3-5
■ Instrucciones específicas de seguridad	5-8
■ Símbolos	9-10
■ Características	11
■ Armado	12-13
■ Batería y cargador	14-15
■ Funcionamiento	16-20
■ Cuidados y mantenimiento	21-25
■ Eliminación ambientalmente segura de la batería	26
■ Resolución de problemas	27
■ Lista de piezas, ilustrada	28-29
■ Números de las figuras (ilustraciones)	i-xi

CRAFTSMAN LIMITED WARRANTY

FOR TWO YEARS from the date of sale, this power tool is warranted against defects in material or workmanship.

FOR ONE YEAR from the sale date a supplied battery pack or charger is warranted against material or workmanship defects.

WITH PROOF OF SALE, a defective product will be replaced free of charge.

For warranty coverage details to obtain free replacement, visit the web page:

www.craftsman.com/warranty

This warranty does not cover the bar and chain which are expendable parts that can wear out from normal use within the warranty period.

This warranty is void if this product is ever used while providing commercial services or if rented to another person.

This warranty gives you specific legal rights, and you may also have other rights which vary from state to state.

Sears Brands Management Corporation, Hoffman Estates, IL 60179

GARANTÍA LIMITADA CRAFTSMAN

* * *

DURANTE DOS AÑOS a contar de la fecha de venta, esta herramienta está garantizada contra defectos en sus materiales o fabricación.

DURANTE UN AÑO a contar de la fecha de venta, la batería o cargador incluidos con la herramienta están garantizados contra defectos en sus materiales o fabricación.

Un producto defectuoso puede reemplazarse por uno nuevo, de manera gratuita, considerando que se presente una PRUEBA DE VENTA.

Para conocer la cobertura de la garantía y obtener un reemplazo gratuito, visite el sitio Web

www.craftsman.com/warranty

Esta garantía no cubre la barra ni la cadena, las cuales son piezas desechables que pueden desgastarse debido al uso normal dentro del periodo de garantía.

La garantía de un año se anula si el producto se usa para proporcionar servicios comerciales o si se le arrienda a otra persona.

Esta garantía le entrega derechos legales específicos que pueden variar según su estado (podría tener otros derechos adicionales).

Sears Brands Management Corporation, Hoffman Estates, IL 60179

INTRODUCTION / INTRODUCCIÓN

This tool has many features for making its use more pleasant and enjoyable. Safety, performance, and dependability have been given top priority in the design of this product making it easy to maintain and operate.

* * *

Esta herramienta tiene muchas funciones para hacerla más agradable y cómoda de usar. Se ha dado máxima prioridad a la seguridad, rendimiento y dependencia en las etapas de diseño de este producto para que sea fácil de utilizar y mantener.

GENERAL SAFETY INSTRUCTIONS

⚠ WARNING!

Read and understand all instructions. Failure to follow all instructions listed below may result in electric shock, fire and/or serious personal injury:

- Keep work area clean and well lit. Cluttered or dark areas invite accidents.
- Do not operate cordless power tools in explosive atmospheres, such as in the presence of flammable liquids, gases, or dust. Cordless power tools create sparks which may ignite the dust or fumes.
- Do not operate in poor lighting.
- Avoid Dangerous Environment - Don't use appliances in damp or wet locations. Don't Use In Rain.
- Keep Children Away - All visitors should be kept at a distance from work area.
- Do not allow to be used as a toy. Close attention is necessary when used by or near children.
- Do not expose cordless power tools to rain or wet conditions. Do not handle plug or tool with wet hands. Water entering the tool will increase the risk of electric shock.
- Do not charge battery in rain, or damp or wet location. Following this rule will reduce the risk of electric shock.
- Do not abuse the charger cord. Never use the cord for carrying, pulling or unplugging. Keep cord away from heat, oil, sharp edges or moving parts. Damaged or entangled cords increase the risk of electric shock. If charger cord is damaged, replace the charger with an identical model as listed in the Product Specifications in this manual.
- Stay Alert - Watch what you are doing. Use common sense. Do not operate tools when you are tired or under the influence of drugs, alcohol or medication. A moment of inattention while operating tools may result in serious personal injury.

- Use personal protective equipment. Always wear eye protection. Protective equipment such as dusk mask, non-skid safety shoes, hard hat, or hearing protection used for appropriate conditions will reduce personal injuries. Secure long hair above shoulder level to prevent entanglement in moving parts.

- Prevent unintentional starting. Ensure switch is in the off-position before installing battery pack, picking up or carrying the tool. Carrying cordless power tools with your finger on the switch or energizing cordless power tools that have the switch on invites accidents.

- Do not overreach. Keep proper footing and balance at all times. This enables better control of the tool in unexpected situations. Operate the tool only when standing on fixed, secure and level surface. Slippery or unstable surfaces such as ladders may cause a loss of balance or control of the product.

- Dress Properly - Do not wear loose clothing or jewelry. They can be caught in moving parts. Use of rubber gloves and substantial footwear is recommended when working outdoors. Wear protective hair covering to contain long hair.

- Wear heavy, long pants, long sleeves, boots, and gloves. Do not wear loose fitting clothing, shorts pants, sandals or similar lightweight footwear or go barefoot.

- Keep all parts of your body away from any moving parts and all hot surfaces of the unit.

CALIFORNIA PROPOSITION 65

⚠ WARNING!

This product and substances that may become airborne from its use may contain chemicals, including lead, known to the State of California to cause cancer, birth defects, or other reproductive harm.

Wash hands after handling.

GENERAL SAFETY INSTRUCTIONS

- Do not use on a ladder, rooftop, tree, or other unstable support. Stable footing on a solid surface enables better control of the tool in unexpected situations.
- Don't Force Power Tool - It will do the job better and with less likelihood of a risk of injury at the rate for which it was designed.
- Do not use the tool if the switch does not turn it on and off. Any cordless power tool that cannot be controlled with the switch is dangerous and must be repaired.
- Disconnect the battery pack from the cordless power tool before making any adjustment, changing accessories, or storing. Such preventive safety measures reduce the risk of starting the power tool accidentally.
- Store Idle Power Tools Indoors - To reduce the risk of serious personal injury, do not store outside or in vehicles. When not in use, appliances should be stored indoors in dry, and high or locked-up place - out of reach of children.
- Do not allow persons unfamiliar with the cordless power tool or these instructions to operate the tool. Cordless power tools are dangerous in the hands of untrained users.
- Maintain tools. Check for misalignment or binding of moving parts, breakage of parts and any other condition that may affect the tool's operation. If damaged, have the tool repaired before use. Many accidents are caused by poorly maintained tools.
- Keep cutting tools sharp and clean. Properly maintained cutting tools with sharp cutting edges are less likely to bind and are easier to control.
- Use the cordless power tool, accessories and tool bits etc., in accordance with these instructions, taking into account the working conditions and the work to be performed.
- Use Right Tool - Do not use appliance for any job except that for which it is intended.
- Recharge only with the charger listed in the Parts List of this manual. A charger that is suitable for one type of battery pack may create a risk of fire when used with another battery pack.
- Use cordless power tools only with specifically designated battery packs. Use of any other battery packs may create a risk of injury and fire.
- Exercise care in handling batteries in order not to short the battery with conducting materials such as rings, bracelets, and keys. The battery or conductor may overheat and cause burns.
- Batteries can explode in the presence of a source of ignition, such as a pilot light. To reduce the risk of serious personal injury, never use any cordless product in the presence of open flame. An exploded battery can propel debris and chemicals. If exposed, flush with water immediately.
- Do not crush, drop or damage the battery pack. Do not use a battery pack or charger that has been dropped or received a sharp blow.
- Do not open or mutilate the batteries. Released electrolyte is corrosive and may cause damage to the eyes or skin. It may be toxic if swallowed.
- Under extreme usage or temperature conditions, battery leakage may occur; liquid may be ejected from the battery; avoid contact. If liquid comes in contact with your skin, wash immediately with soap and water, then neutralize with lemon juice or vinegar. If liquid gets into your eyes, flush them with clean water for at least 10 minutes, then seek immediate medical attention. Following this rule will reduce the risk of serious personal injury.
- Do not dispose of battery packs in fire. They will explode or leak and cause injury. Liquid ejected from the battery may cause irritation or burns.
- Have your tool serviced by a qualified service center using only identical replacement parts. This will ensure that the safety of the power tool is maintained.
- Use only the following model number battery: 71.98724 (24LB2513)

SPECIFIC SAFETY INSTRUCTIONS

- Keep all parts of the body away from the saw chain. Do not remove cut material or hold material to be cut when saw chain is moving. Make sure the switch is off when clearing jammed material. A moment of inattention while operating the pole saw may result in serious personal injury.
- Hold the pole saw by insulated gripping surfaces only, because the saw chain may contact hidden wiring. Saw chains contacting a “live” wire may make exposed metal parts of the pole saw “live” and could give the operator an electric shock.
- Keep all parts of the body away from the saw chain when operating the pole saw. Before you start the pole saw, make sure the saw chain is not contacting anything. A moment of inattention while operating may cause entanglement of your clothing or body with the saw chain.
- Always hold the pole saw with both hands on the handle. Holding the pole saw with only one hand or on parts not intended for that increases the risk of personal injury and should never be done.
- Wear safety glasses and hearing protection. Further protective equipment for head, hands, legs and feet is recommended. Adequate protective clothing will reduce personal injury by flying debris or accidental contact with the saw chain.
- Do not operate pole saw in a tree. Operation of a pole saw while up in a tree may result in personal injury.
- When cutting a limb that is under tension be alert for spring back. When the tension in the wood fibers is released, the spring loaded limb may strike the operator and/or throw the pole saw out of control.
- Use extreme caution when cutting brush and saplings. The slender material may catch the saw chain and be whipped toward you or pull you off balance.
- Carry the pole saw by the soft grip with the product switched off and away from your body. When transporting or storing the pole saw always fit the scabbard. Proper handling of the product will reduce the likelihood of accidental contact with the moving saw chain.
- Follow instructions for lubricating, chain tensioning and changing accessories. Improperly tensioned or lubricated chain may either break or increase the chance for kickback.
- Keep handles dry, clean, and free from oil and grease. Greasy, oily handles are slippery causing loss of control.
- Cut wood only. Do not use product for purposes not intended. For example: do not use pole saw for cutting plastic, masonry or non-wood building materials. Use of the pole saw for operations different than intended could result in a hazardous situation.
- Pay attention to national and local regulations. National and local regulations may restrict the use of this product.
- Do not operate a pole saw that is damaged, improperly adjusted, or not completely and securely assembled. Chain should stop turning when the trigger switch is released. If chain turns after the trigger switch has been released, discontinue pole saw use immediately. If within warranty period, return unit to retailer of purchase for replacement.
- Only use replacement guide bars and saw chains as Listed in the Product Specifications in this manual. Incorrect replacement bars and chains may cause chain breakage and/ or kickback, resulting in personal injuries and damage to property.
- Never remove or modify any guard or safety component. Ensure that guards and other safety components necessary for machine operation are in position, in good working condition and properly maintained to avoid injuries.

SPECIFIC SAFETY INSTRUCTIONS

KICKBACK

Kickback may occur when the nose or tip of the guide bar touches an object, or when the wood closes in and pinches the saw chain in the cut.

Tip contact in some cases may cause a sudden reverse reaction, kicking the guide bar up and back towards the operator.

Pinching the saw chain along the top of the guide bar may push the guide bar rapidly back towards the operator.

Either of these reactions may cause you to lose control of the saw which could result in serious personal injury. Do not rely exclusively upon the safety devices built into your saw. As a product user, you should take several steps to keep your cutting jobs free from accident or injury.

Kickback is the result of tool misuse and/or incorrect operating procedures or conditions and can be avoided by taking proper precautions as given below:

- Maintain a firm grip, with thumbs and fingers encircling the product handles, with both hands on the saw and position your body and arms to allow you to resist kickback forces. Kickback forces can be controlled by the operator, if proper precautions are taken. Do not let go of the product.

- Make sure that the area in which you are cutting is free from obstructions. Do not let the nose of the guide bar contact a log, branch, fence, or any other obstruction that could be hit while you are operating the saw.

- Do not overreach. This helps prevent unintended tip contact and enables better control of the product in unexpected situations.

- Use replacement parts such as low kickback chain and special guide bars that reduce the risks associated with rotational kickback.

- Use only the replacement guide bars and low kickback chains specified by the manufacturer for the saw.

- Follow the sharpening and maintenance instructions for the saw chain. Decreasing the depth gauge height can lead to increased kickback.

VIBRATION AND NOISE REDUCTION

To reduce the impact of noise and vibration emission, limit the time of operation, as well as wear personal protective equipment.

Take the following points into account to minimize the vibration and noise exposure risks:

- Only use the product as intended by its design and these instructions.

- Ensure that the product is in good condition and well maintained.

- Use correct cutting attachments for the product and ensure they are in good condition.

- Keep a tight grip on the handles/grip surface.

- Maintain the pole saw in accordance with these instructions and keep it well lubricated (where appropriate).

- Plan your work schedule to spread any high vibration tool use across a longer period of time.

EMERGENCY

Familiarize yourself with the use of this product by means of this instruction manual. Memorize the safety directions and follow them to the letter. This will help to prevent risks and hazards.

- Always be alert when using this product, so that you can recognize and handle risks early. Fast intervention can prevent serious injury and damage to property.

- Switch off and remove the battery pack if there is any malfunction. Have the product checked by a qualified service center and repaired, if necessary, before you put it into operation again.

SPECIFIC SAFETY INSTRUCTIONS

RESIDUAL RISKS

Even if you are operating this product in accordance with all the safety requirements, potential risks of injury and damage remain. The following dangers can arise in connection with the structure and design of this product:

- Health defects resulting from vibration emission if the product is being used over long periods of time or not adequately managed and properly maintained.
- Injuries and damage to property due to broken accessories or the sudden impact of hidden objects during use.
- Danger of injury and property damage caused by flying objects.
- Kickback
- Prolonged use of this product exposes the operator to vibrations and may produce 'white finger' disease. In order to reduce the risk, please wear gloves and keep your hands warm. If any of the 'white finger' symptoms appear, seek medical attention immediately. 'White finger' symptoms include: numbness, loss of feeling, tingling, pricking, pain, loss of strength, changes in skin color or condition. These symptoms normally appear in the fingers, hands or wrists. The risk increases at low temperatures.

BATTERY CHARGER

Warning: Changes or modifications to this unit not expressly approved by the party responsible for compliance could void the user's authority to operate the equipment.

NOTE: This equipment has been tested and found to comply with the limits for a Class B digital device, pursuant to Part 15 of the FCC Rules. These limits are designed to provide reasonable protection against harmful interference in a residential installation.

This equipment generates, uses and can radiate radio frequency energy and, if not installed and used in accordance with the instructions, may cause harmful interference to radio communications.

However, there is no guarantee that interference will not occur in a particular installation. If this equipment does cause harmful interference to radio or television reception, which can be determined by turning the equipment off and on, the user is encouraged to try to correct the interference by one or more of the following measures:

- Reorient or relocate the receiving antenna.
- Increase the separation between the equipment and receiver.
- Connect the equipment into an outlet on a circuit different from that to which the receiver is connected.
- Consult the dealer or an experienced radio/TV technician for help.













⚠ WARNING!

This product produces an electromagnetic field during operation! This field may under some circumstances interfere with active or passive medical implants! To reduce the risk of serious or fatal injury, we recommend persons with medical implants to consult their doctor and the medical implant manufacturer before operating this product!











SAVE THESE INSTRUCTIONS

SYMBOLS



Some of the following symbols may be used on this product. Please study them and learn their meaning. Proper interpretation of these symbols will allow you to operate the product better and safer.

SYMBOL	NAME	DESIGNATION/EXPLANATION
V	Volts	Voltage
A	Amperes	Current
Hz	Hertz	Frequency (cycles per second)
W	Watt	Power
hrs	Hours	Time
/min	Per Minute	Revolutions, strokes, surface speed, orbits etc., per minute
n_o	No Load Speed	Rational speed, at no load
	Alternating Current	Type of current
	Direct Current	Type or a characteristic of current
	Lithium-Ion Battery Recycling	Designates that this tool is in compliance with Lithium-Ion battery recycling program requirements
	Safety Alert	Indicates a potential personal injury hazard.
	Read The Operator's Manual	To reduce the risk of injury user must read and understand operator's manual before using this product.
	Gloves	Wear non-slip, heavy-duty protective gloves when handling this product.
	Safety Footwear	Wear non-slip safety footwear when using this product.
	Wet Conditions Alert	Do not expose to rain or use in damp locations.
	Risk of Electrocution	DANGER! Risk of electrocution!
	Electric Shock	Failure to use in dry conditions and to observe safe practices can result in electric shock.
	No Hands Symbol	Failure to keep your hands away from the blade will result in serious personal injury.
	Keep Bystanders Away	Keep all bystanders at least 50' (15 m) away.
	Rain Alert	Do not expose to rain or wet conditions.

SYMBOLS

SYMBOL	NAME	DESIGNATION/EXPLANATION
	Eye Protection	Wear eye protection.
	Ear Protection	Wear ear protection.
	Bar Nose Contact	Avoid bar nose contact.
	Kickback	DANGER! Beware of kickback.
	One handed	Do not operate the saw using only one hand.
	Operate With Two Hands	Hold and operate the saw properly with both hands.
	Keep Away From Water	Do not dispose of battery packs in rivers or immerse in water.
	Keep Away From Fire	Do not dispose of battery packs in fire. They will explode or leak and cause injury.
	Heat Alert	Do not expose battery packs to heat in excess of 60°C.
	Recycle Symbol	This product uses lithium-ion batteries. Local, state, or federal laws may prohibit disposal of batteries in ordinary trash. Consult your local waste authority for information regarding available recycling and/or disposal options.

The following signal words and meanings are intended to explain the levels of risk associated with this product.

SYMBOL	SIGNAL	MEANING
	DANGER	Indicates an imminently hazardous situation, which, if not avoided, will result in death or serious injury.
	WARNING	Indicates a potentially hazardous situation, which, if not avoided, could result in death or serious injury.
	CAUTION	Indicates a potentially hazardous situation, which, if not avoided, may result in minor or moderate injury.
	CAUTION	(Without Safety Alert Symbol) Indicates a situation that may result in property damage.

FEATURES

PRODUCT SPECIFICATIONS

Type.....	Cordless, battery-powered
Motor	24V max* d.c.
Guide Bar Length	8 inch
Oil Tank Capacity.....	70 ml
Chain Speed.....	14.4 ft/s (4.4 m/s)
Max. Cutting Diameter.....	6.9 inch
Weight with Battery.....	10.52 lbs (4.77 kg)
Weight without Battery.....	9.48 lbs (4.3 kg)

BatteryMODEL #71.98724 (24LB2513) 24V max* d.c., 2.5 Ah Lithium-Ion

Charger

Model No.	24LFC14-ETL
Rated Input Voltage	120VAC
Rated Output Voltage	24VDC
Rated Output Current	2.5A
Charging Time from Zero to Full Charge	70 minutes

Bar and Saw Chain

Oregon® Bar = 581851 Oregon® Chain = 91PX033X

KNOW YOUR POLE SAW

See Figure 1, page i

The safe use of this product requires an understanding of the information on the product and in this operator's manual as well as a knowledge of the project you are attempting. Before use of this product, familiarize yourself with all operating features and safety instructions.

NOTE: BAR & CHAIN OIL NOT INCLUDED.
BAR & CHAIN OIL MUST BE ADDED
PRIOR TO USE.



REUSABLE SCABBARD

The scabbard keeps the operator from coming in contact with the sharp chain when the tool is not in use. It also helps keep the saw chain from being nicked or damaged when the tool is in storage.

SHOULDER STRAP

The shoulder strap helps the operator to carry the product.

CHAIN TENSIONING KNOB

This feature allows user to adjust the tension of the chain.

QUICK-VIEW OIL INDICATOR

Semi-transparent oil reservoir that allows user to see when to add oil.

ASSEMBLY

UNPACKING

This product requires assembly.

- Carefully remove the product and any accessories from the box. Make sure that all items listed in the packing list are included.

 **WARNING!** Do not use this product if any of the separately listed parts in the Packing List are already assembled to your product when you unpack it. Parts on this list are not assembled to the product by the manufacturer and require customer installation. Use of a product that may have been improperly assembled could result in serious personal injury.

- Inspect the product carefully to make sure no breakage or damage occurred during shipping.
- Do not discard the packing material until you have carefully inspected and satisfactorily operated the product.
- If any parts are damaged or missing, do not operate the product. Return it for replacement to the retailer from which it was purchased.

151.74326 (KIT) PACKING LIST

Upper Pole with Bar, Chain and Scabbard
Lower Pole with Main Handle and Switch
Extension Pole with Locking Collar
Auxiliary handle with Locking Knob and Bolt
Shoulder Strap
Strap Hanger
(1) 24V Max* 2.5 Ah Lithium-Ion Battery
(1) 24V Max* Battery Charger
Operator's Manual

151.74926 (TOOL ONLY) PACKING LIST

Upper Pole with Bar, Chain and Scabbard
Lower Pole with Main Handle and Switch
Extension Pole with Locking Collar
Auxiliary handle with Locking Knob and Bolt
Shoulder Strap
Strap Hanger
Operator's Manual

BATTERY

IMPORTANT! The battery pack is not charged when the pole saw is purchased. Before using the pole saw, read all safety precautions and follow the instructions in the Battery Pack And Charger section. With regular use, the battery pack will need shorter charging time. When storing the pole saw, remove the battery pack. When ready to use pole saw again, charge the battery pack for at least 70 minutes.

 **WARNING!** If any parts are damaged or missing do not operate this product until the parts are replaced. Use of this product with damaged or missing parts could result in serious personal injury.

 **WARNING!** Do not attempt to modify this product or create accessories not recommended for use with this product. Any such alteration or modification is misuse and could result in a hazardous condition leading to possible serious personal injury.

 **WARNING!** To prevent accidental starting that could cause serious personal injury, always remove the battery pack from the product when assembling parts.

AUXILIARY HANDLE ASSEMBLY

See Figures 2-3, page ii

 **WARNING!** Never use the product without the auxiliary handle properly fitted!

- Loosen the locking knob from the auxiliary handle.
- Align the auxiliary handle with the lower pole. (Fig. 2)
- Adjust the auxiliary handle to the most comfortable position.
- Insert the bolt in the hole on the auxiliary handle, tighten the locking knob and clamp the lever down to secure it. (Fig. 3)

ASSEMBLY

NOTE: User can adjust the auxiliary handle to the desired height position for better use.

Follow the steps below to adjust the handle:

- Loosen the locking knob until the auxiliary handle can slide up or downward.
- Adjust the auxiliary handle to the desired height position.
- Tighten the locking knob to secure it and clamp down to secure handle.

POLE ASSEMBLY

See Figure 4, page ii

- Align the lower pole with the extension pole. The triangle-shaped recesses must face each other.
- Insert the lower pole into the extension pole. Secure the connection with the locking collar.
- Repeat the same operations above to assemble the upper pole.

NOTE: The upper pole can be directly connected to the lower pole if the added length of the extension pole is not required.

CHAIN AND GUIDE BAR ASSEMBLY

The saw chain and guide bar are pre-assembled at delivery. Inspect and re-assemble them before operation if necessary.

Use only the guide bar and saw chain according to the Product Specifications of the product.

To remove and replace bar and saw chain, refer to REPLACING THE GUIDE BAR AND CHAIN in the CARE AND MAINTENANCE section of this manual.

NOTE: BAR & CHAIN OIL NOT INCLUDED. BAR & CHAIN OIL MUST BE ADDED PRIOR TO USE.

STRAP HANGER AND SHOULDER STRAP ASSEMBLY

See Figures 5-8, page ii-iii

The shoulder strap helps the operator to carry the product.

- Pull strap hanger apart and place over lower pole. Adjust the strap hanger to the desired height position. Tighten the bolt to secure it. (Fig. 5)
- Place shoulder strap over your left shoulder or on the right shoulder (Figs. 6-7) and attach shoulder strap clip to strap hanger (Fig. 8). Adjust the length of the shoulder strap if required.



WARNING! Always use the product with the shoulder strap! Do not carry it only with your hands!

- Open the shoulder strap clip to remove the shoulder strap from the strap hanger.
- In case of an emergency that requires you to distance yourself from the saw, be sure to first remove the strap from your shoulder.

Adjust the strap hanger as below:

- Loosen the bolt until you can slide the strap hanger up or downward.
- Adjust the strap hanger to the desired height position.
- Tighten the bolt to secure it.

BATTERY PACK AND CHARGER

BECOME FAMILIAR WITH THE CHARGER

See Figure 9, page iii

Before attempting to use this charger, become familiar with all of its operating features and safety requirements.

CHARGING THE BATTERY PACK

See Figure 10, page iii

WARNING!

- If any part of the charger is missing or damaged, do not operate it! Replace the charger with a new one. Failure to heed this warning could result in possible serious injury.
- Check the voltage! The voltage must comply with the information on the rating label.

BATTERY CHARGING PROCEDURE

- Align the battery pack to the slots on the charger and slide it in until it locks in place.
- Connect the charger to the power supply.
- Allow sufficient charging time (see Product Specifications), and then disconnect the charger from the power supply.
- Press the release button on the battery pack and remove it from the charger.

NOTE: It is normal for the battery pack and charger to become warm (but not hot) during charging process. If the battery does not charge properly, check to make sure the electrical outlet is "live".

Always charge the battery before storage!





 WARNING! To reduce risk of fire, never leave the battery connected with the charger for more than 24 hours!

- Do not use other battery chargers. The battery charger supplied is specifically designed for the Lithium-Ion battery used in this garden appliance.
- Check the main power supply! The voltage of the power supply must correspond with the data on the nameplate of the battery charger. Battery chargers operate on 120V.
- The battery is equipped with a temperature monitor that allows charging only within a temperature range between 23°F and 122°F. This ensures an optimum battery service life.

NOTE: The battery is supplied partially charged. To ensure full capacity of the battery, charge the battery in the battery charger before using the product for the first time. The Lithium-Ion battery can be charged at any time without reducing its service life. Interrupting the charging procedure does not affect the battery.

CHARGER INDICATORS

- **Preparation:** The charging process starts as soon as the battery charger is plugged into a power supply socket and the battery is inserted into the charger.
- If the battery is not inserted, a **continuous red light** indicates that the charger is plugged into a power supply socket and is now ready to begin charging.
- **Charging: a flashing green LED** on the charger indicates that the battery is charging normally.
- **Charged: continuous green LED** on the charger indicates that the battery is ready for use.
- The indicator lights on the charger show the charger status:

SYMBOL	INDICATOR LIGHTS	STATUS
	red, blinking	charging problem; see Technical Issue info on next page
	red, continuous	connected to power supply
	green, blinking	charging
	green, continuous	fully charged

Charger Indicator Panel

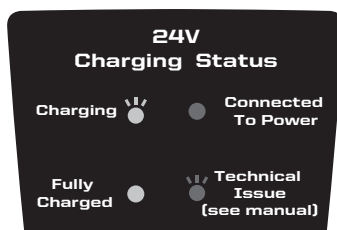

BATTERY PACK AND CHARGER

- The intelligent charger ensures maximum battery life, because it measures the existing charge level of the battery and then charges with the required current and voltage. Charge battery fully before storage.

- **Technical Issue: a flashing red LED light** on the charger indicates that battery pack has a charging problem or might be defective.

- One possible condition is the battery temperature is not within the charging temperature range of 23°F - 122°F or the charging current is too high. As soon as the permitted temperature and the charging current ranges are reached, the battery charger will automatically switch to charging.

- If the temperature range and charging current are correct and flashing red LED light continues, then remove and reinstall the battery pack. If the LED status repeats a second time, try to charge another identical battery. If the battery charges normally, dispose of the defective battery pack (see Environmentally Safe Battery Disposal section).

- If the flashing red light continues after installing the second battery, the charger may be defective. Replace with a new one.

- After continuous or repeated charging cycles without interruption, the charger surface may become noticeably warm. This is normal and does not indicate a technical defect of the battery charger.

- **Green LED flashing rapidly** indicates that the battery voltage is low, and that charging will only continue for about another 30 minutes.

⚠ WARNING! To avoid risk of fire, electric shock, or electrocution:





- Do not use a damp cloth or detergent on the battery or battery charger.





- Always remove the battery pack before cleaning, inspecting, or performing any maintenance on the product.

BATTERY LED INDICATORS

Check the battery pack capacity by pressing the LED button.

When the LED button is pressed, the number of illuminated lights indicates the state of battery pack capacity. See Table below.

NUMBER of LIGHTED LEDs	CAPACITY
	0%-25%
	25%-50%
	50%-75%
	75%-100%

SAFETY NOTES AND PRECAUTIONS

- Do not disassemble the battery.
- Keep away from children.
- Do not expose the battery to water or salt water. You should place the battery in a cool and dry environment.
- Do not place the battery in high-temperature locations, such as fire or heater.
- Do not reverse the positive terminal and the negative terminal of the battery.
- Do not connect the positive terminal and the negative terminal of the battery to each other with any metal objects.
- Do not knock or strike the battery, nor step on it.
- Do not solder directly onto the battery or pierce the battery with nails or other edge tools.
- In the event that battery leaks and fluid gets into your eyes, do not rub the eyes. Rinse well with water. Immediately discontinue use of the battery if it emits an unusual smell, feels hot, changes color, changes shape, or appears abnormal in any other way.

OPERATION

⚠ WARNING! Do not allow familiarity with products to make you careless. Remember that a careless fraction of a second is sufficient to inflict serious injury.

⚠ WARNING! Always wear eye protection with side shields marked to comply with ANSI Z87.1, along with head protection. Failure to do so could result in objects being thrown into your eyes and other possible serious injuries.

⚠ WARNING! Do not use any attachments or accessories not recommended by the manufacturer or retailer of this product. The use of attachments or accessories not recommended can result in serious personal injury.

Before each use, inspect the entire product for damaged, missing, or loose parts such as screws, nuts, bolts, caps, etc. Tighten securely all fasteners and caps and do not operate this product until all missing or damaged parts are replaced.

APPLICATIONS

The pole saw is intended for cutting limbs with a thickness of max. 6.9 in. It must not be used for cutting other materials, such as plastic, stone, metal or wood that contains foreign objects, or materials that are harmful to health. It must not be used for any purposes other than those described.

Use only the guide bar and saw chain listed in the Product Specifications of this manual.

To reduce the risk of injury, read the entire manual before first operation and to observe all the instructions therein.

CHAIN OIL SYSTEM

See Figure 12, page iv

Check and fill the oil reservoir when battery is recharged, or as needed.

⚠ CAUTION! Remove battery pack from unit before checking and filling oil reservoir. Fill oil reservoir with Bar and Chain Oil before starting the pole saw. Failure to lubricate the chain will cause damage to the bar and chain.

⚠ WARNING! Running the saw dry or with too little oil will decrease cutting efficiency, shorten product life, and cause rapid wear to the chain and bar from overheating! Insufficient oil is evidenced by smoke or bar discoloration! Adequate lubrication of the saw chain during cutting operations is essential to minimize friction with the guide bar!

NOTE: Do not use dirty, used or otherwise contaminated oils. Damage may occur to the bar or chain. Use a proper funnel with a filter to prevent debris entering the reservoir and to avoid splitting and overfilling the reservoir.

To fill reservoir:

- Place the product on a suitable flat surface with oil reservoir cap facing upward.
- Remove the oil reservoir cap.
- Carefully pour the bar and chain oil into the reservoir. We recommend using environmentally friendly chain oil specially intended to be used with this product.
- Wipe off excess oil from around the reservoir.

NOTE: It is normal for oil to seep from the saw when not in use. To prevent seepage, empty the oil reservoir after each use. When storing the unit for a long period of time (three months or longer) be sure the chain is lightly lubricated; this will prevent rust on the chain and bar sprocket.

NOTE: Always dispose of lubricant, used oil and objects contaminated with them in accordance with local regulations.

OPERATION

CHECKING OIL LEVEL

See Figure 11-13, page iv

- Do not overfill. Leave approximately 0.2 in. (5 mm) of space to the lower edge to allow the lubricant to expand. (Fig. 11)
- Check the oil level prior to switching on and regularly during operation. Refill oil when the oil level is low. (Fig. 12)
- Wipe up spilled oil with a soft cloth and refit the reservoir cap.

NOTE: Check the chain lubrication before each use.

- Make sure the guide bar and the saw chain are in place when you check the oil delivery.
- Switch on the product (see section "STARTING THE POLE SAW"); keep pressing the power switch and check if the chain oil is delivered as shown in the figure. (Fig. 13)

TILT ADJUSTMENT

See Figure 14-15, page iv

Adjust the angle of the cutting head to fit the operation conditions.

- Press the pivot button and hold it in position. (Fig. 14, step 1)
- Move the cutting head slightly up or downward.
- Release the pivot button and keep moving the cutting head until it locks in place. (Fig. 14, step 2)

! WARNING! Always ensure that the pivot button snaps into place after adjusting the cutting head in one of the 6 indicated positions! Never adjust to an intermediate position! (Fig. 15)

TO INSTALL / REMOVE BATTERY PACK

See Figures 16-17, page v

! WARNING! Always remove battery pack from your tool when you are assembling parts, making adjustments, cleaning, carrying, transporting or when not in use. Removing battery pack will prevent accidental starting that could cause serious personal injury.

NOTE: To avoid serious personal injury, always remove the battery pack and keep hands clear of the safety switch when carrying or transporting the tool.

To install: (Fig. 16)

- Align the tongue of the battery pack with the slots of the battery dock.
- Grasp the pole saw firmly.
- Push the battery pack into the pole saw until the latch locks into place.
- Do not use force when inserting the battery pack. It should slide into position and "click".

To remove: (Fig. 17)

- Press the release button on the battery pack to release the battery pack from the pole saw.
- Grasp the pole saw firmly, and pull the battery pack out.

STARTING / STOPPING THE POLE CHAIN

See Figure 18, page v

NOTE: Carefully remove the scabbard from the bar before starting the pole saw and place scabbard over the bar when pole saw is not in use.

OPERATION

Starting the pole saw:

- Make sure chain tension is at desired setting. Refer to SAW CHAIN TENSIONING in the CARE AND MAINTENANCE section of this manual.
- Ensure the saw chain and guide bar do not come into contact with anything before starting the product.
- Press and hold the safety switch. This makes the power switch operational.
- Press and hold the power switch, release the safety switch, and continue to squeeze the power switch for continued operation.

Stopping the pole saw:

NOTE: It is normal for the chain to coast to a stop once the power switch is released.

 **WARNING!** NEVER touch the chain while it is moving. Even a slowly moving chain can cause serious personal injury if touched.

- Release the power switch to stop the pole saw.
- Upon release of the power switch, the safety switch will be automatically reset to the lock position.

GENERAL OPERATION

- Check the product, its battery pack and charger as well as accessories for damage before each use. Do not use the product if it is damaged or shows wear.
- Double check that accessories and the guide bar/saw chain are properly fixed.
- Check the chain oil level and refill if necessary.
- Always hold the product firmly by its handles. Keep the handles dry and clean to ensure safe support.
- Ensure that the air vents are always unobstructed and clear. Clean them if necessary with a soft brush. Blocked air vents may lead to overheating and damage the product.

- Switch the product off immediately if you are disturbed while working by other people entering the working area. Always let the product come to complete stop before putting it down.

- Do not overwork yourself. Take regular breaks to ensure you can concentrate on the work and have full control over the product.

PRUNING

See *Figures 19-26, page v-vi*

The pole saw is designed for pruning. Pruning is the action of sawing limbs from standing trees.

Kickback:

 **WARNING!** Beware of kickback! Kickback can lead to dangerous loss of control of the product and result in serious or fatal injury to the operator or anyone standing close by! Always be alert because rotational kickback and pinch kickback are major product operational dangers and the leading cause of most accidents!

- Kickback is the sudden backward/upward motion of the product, occurring when the chain (at the tip of the chain bar) comes in contact with a log or wood, or when the chain becomes jammed.

- When kickback occurs the product reacts unpredictably and can cause severe injuries to the operator or bystanders.

- With a basic understanding of 'kickback', the element of surprise can be reduced or eliminated. Sudden surprise contributes to the majority of accidents.

- Read all the safety warnings and user instructions carefully before attempting to operate this product.

To avoid kickback:

- Always hold the product firmly with both hands.

- Follow the chain sharpening and maintenance instructions in the CARE AND MAINTENANCE section of this manual.

OPERATION

Ensure correct chain tension. Ensure the chain is sharpened correctly.

- Never work with a loose, widely stretched or heavily worn chain.
- Always use a low kickback chain.
- Only replace the guide bar and saw chain with the identical parts as specified in the Product Specifications of this manual.
- Do not let the nose of the guide bar contact a log, branch, or any other obstruction which could be hit while you are operating the product.
- Never work with the tip of the guide bar.
- Use spiked bumper to secure the product onto the limb being sawed.
- Saw with the guide bar at a flat angle.
- Only cut with the motor at high speeds.

Pruning Operation:

- Always hold the product firmly with both hands on auxiliary handle and main handle. Never operate this product using only one hand. (Fig. 19)
- Maintain a firm grip with your thumbs and fingers encircling the handles. A firm grip will help you reduce 'kickback' and maintain control of the product.
- Always hold the product at an angle of not more than 60° from the horizontal level. Otherwise safe operation is not possible. (Fig. 20)
- Never stand directly under the limb you are sawing. Objects may fall different than expected. There is risk of being struck by falling branches or by those that rebound after hitting the ground. Always position yourself out of the path of falling limbs. (Fig. 21)
- Keep other persons away from cutting end of product and at a safe distance from the work area. Maintain a minimum distance of 50 ft to bystanders. (Fig. 22)

 **WARNING!** Never climb into a tree to prune! Do not stand on ladders, platforms, logs, or in any position which may cause you to lose your balance or control of the product! When pruning trees, it is important not to make the flush cut next to main limb or trunk until you have cut off the limb further out to reduce the weight! This prevents stripping the bark from the main member.

- Never stand on a ladder or other type of unstable support while using the product. Insecure stand invites hazards. (Fig. 23)

 **WARNING!** This product has not been designed to provide protection from electric shock in the event of contact with overhead electric lines! Therefore do not use product near cable, electric power or telephone lines. Keep a minimum distance of 50 ft to all electric lines! (Fig. 24)

- Use the product only with secure footing. Regularly change the working position and include rest periods during operation.
- Do not operate the product with arms fully extended or attempt to cut areas which are difficult to reach.
- Keep a firm, steady pressure on the product while working with it. Do not try to force the product through the wood; let the gripping action of the saw chain teeth do the work, allowing you to apply minimal leverage pressure.
- Beware when reaching the end of the cut. The weight of the product may change unexpectedly as it cuts free from the wood. Accidents can occur to the legs and feet. Always remove the product from a wood cut while it is running.

NOTE: The chain must be running at full speed before it comes into contact with the wood.

OPERATION

Thin branches: (Fig. 25)

- Thin branches can be cut through with one single cut. To prevent the branch from splintering and buckling, the branch should be cut off in several pieces.

Thick branches: (Fig. 26)

- When cutting off larger branches, three cuts are necessary.

- First cut into the branch from below and outside of the place where you intend to cut

off the branch. The cut should go from one third to halfway through the branch. (A)

- Make a second cut from the top side of the limb outboard from the first cut. (B)

- Last, cut off the stump with one clean cut from top to bottom. (C)

NOTE: Remove the branches lying on the ground regularly to avoid stumbling hazards. Check the oil level regularly and fill up if necessary. Switch the power off and remove the battery pack when leaving the product.

CARE AND MAINTENANCE

⚠ WARNING! When servicing, use only identical replacement parts. Use of any other parts may create a hazard or cause product damage.

⚠ WARNING! Always wear eye protection with side shields marked to comply with ANSI Z87.1, along with hearing protection. Failure to do so could result in objects being thrown into your eyes resulting in possible serious injuries. If operation is dusty, also wear breathing protection.

⚠ WARNING! To avoid serious personal injury, always remove the battery pack from the tool when cleaning or performing any maintenance.

⚠ WARNING! Always switch the product off, remove the battery pack and let the product cool down before performing inspection, maintenance and cleaning work!

- Keep the product clean. Remove debris from it after each use and before storage.
- Regular and proper cleaning will help ensure safe use and prolong the life of the product.
- Inspect the product before each use for worn and damaged parts. Do not operate it if you find broken and worn parts.

⚠ WARNING! Only perform repairs and maintenance work according to these instructions! All further works must be performed by a qualified specialist!

GENERAL MAINTENANCE

Avoid using solvents when cleaning plastic parts. Most plastics are susceptible to damage from various types of commercial solvents and may be damaged by their use. Use clean cloths to remove dirt, dust, oil, grease, etc.

⚠ WARNING! Do not at any time let brake fluids, gasoline, petroleum-based products, penetrating oils, etc., come in contact with plastic parts. Chemicals can damage, weaken or destroy plastic which can result in serious personal injury.

GENERAL CLEANING

- Clean the product with a clean cloth. Use a brush for areas that are hard to reach.
- In particular clean the air vents after every use with a cloth and brush.
- Remove stubborn dirt with high pressure air (max. 3 bar).
- Check for any damage and wear. Repair damages in accordance with this instruction manual or take it to a qualified service center before using the product again.

BATTERY PACK

- Store the battery pack fully charged.
- Recharge the battery pack whenever there is a noticeable reduction in pole saw performance. Do not allow the battery pack to become completely discharged.
- Do not recharge a battery pack that is already fully charged. Overcharging shortens battery life.
- Once the battery pack is fully charged, remove the battery from the charger and disconnect the charger from the outlet.
- Do not store the battery pack on the tool or in the charger.
- Recharge the battery at a temperature between 23°F and 122°F. If the battery pack is hot, allow it to cool down before recharging.

CHARGER MAINTENANCE

- Keep the charger clean and clear of debris. Do not allow foreign material to get into the recessed cavity or onto the contacts. Wipe the charger clean with a dry cloth. Do not use solvents or water, and do not place the charger in wet conditions.

CARE AND MAINTENANCE

- Unplug the charger when there is no battery pack in it.
- Keep the charger stored in normal room temperature. Do not store it in excessive heat. Do not use in direct sunlight.

LUBRICATION

All of the motor bearings in this product are lubricated with a sufficient amount of high-grade oil for the life of the unit under normal operating conditions. Therefore, no further lubrication is required.

BAR NOSE LUBRICATION

See Figures 27, page vii

- Clean the bar nose. Using a disposable lube gun, insert the applicator into the lubrication hole and inject grease until it appears at the outside edge of the bar nose sprocket.
- Repeat the lubrication procedure until all of the bar nose sprocket teeth have been greased.

REPLACING THE GUIDE BAR AND CHAIN

See Figures 28-35, page vii-ix

⚠ WARNING! To avoid serious personal injury, read and understand all the safety instructions in this section.

⚠ WARNING! Before performing any maintenance, remove the battery pack from the tool. Failure to heed this warning could result in serious personal injury.

⚠ CAUTION! Always wear gloves when handling the bar and chain. These components are sharp and may contain burrs.

⚠ WARNING! Never touch or adjust the chain while the motor is running. The saw chain is very sharp. Always wear protective gloves when performing maintenance involving the chain to avoid possible serious lacerations.

Removing the guide bar and chain:

- Place the product on a suitable flat surface.
- Loosen the locking knob and remove the cover. (Fig. 28)
- Remove bar and chain assembly from support bolt. (Fig. 29)

Installing the guide bar and chain:

⚠ DANGER! Never start the motor before installing the guide bar, chain, cover, and locking knob. Without all these parts in place, the clutch can fly off or explode, exposing the user to possible serious injury.

⚠ WARNING! Keep all parts of the body away from the pole saw when the pole saw is operating. Before you start the pole saw, make sure the pole saw is not contacting anything.

A moment of inattention while operating pole saw may cause entanglement of your clothing or body with the saw chain.

⚠ WARNING! Always use a saw chain designed as “low-kickback” or a saw chain which meets the low-kickback requirements! A standard saw chain (a chain which does not have the kickback reducing guard links) should only be used by an experienced professional operator!

To install guide bar:

- Use only a guide bar and saw chain as listed in the Product Specifications of this manual.
- Lay the saw chain into the groove of the bar with the cutting edges of the chain pointing in the rotational direction shown on the bar. (Fig. 30)
- Ensure that the guide bar tension disc is adjusted to the outermost position away from the bar; turn the disc counterclockwise if required. (Fig. 31)

CARE AND MAINTENANCE

- Lay the saw chain around the drive sprocket, and lay the guide bar against the saw body so that the support bolt protrudes through the hole in the guide bar tension disc. (Figs. 32-33)

⚠ WARNING! The direction of the saw chain 'cutters' must be as indicated by the symbol and arrow on the guide bar!

- The saw chain movement is as indicated by the arrow on the guide bar. (Fig. 34)
- Replace the chain cover and slightly tighten the locking knob. (Fig. 35)
- Do not tighten the locking knob completely; saw chain tensioning is required first.

NOTE: The saw chain has not yet been tensioned. Tension the chain as described under "Saw chain tensioning" in this Care and Maintenance section.

SAW CHAIN TENSIONING

See *Figures 36-41, page ix-x*

⚠ WARNING! Never touch or adjust the chain while the motor is running. The saw chain is very sharp. Always wear protective gloves when performing maintenance involving the chain.

- Always check the saw chain tension before use, after the first cuts, regularly during use, approximately every five cuts.
- Upon initial operation, new chains can lengthen considerably. This is normal during the break-in period and the interval between future adjustments will lengthen quickly.
- To tension chain, first set the pole saw on a suitable flat surface.
- Turn the tensioning knob clockwise until the chain 'tie straps' are just touching the bottom edge of the guide bar. (Fig. 36)

TENSION TEST

- Check the chain tension by using one hand to lift the chain above the edge of the bar.

The tension is correct when the chain lifts so that the tie straps are approximately 3/32 - 5/32 in. (2 - 4 mm) above the bar edge. (Figs. 37)

- Adjust the tension if you find that the pole saw is too loose or tight. Turn the chain tensioning knob clockwise to tighten and counterclockwise to loosen the chain tension.

NOTE: A cold chain is correctly tensioned when there is no slack on the underside of the guide bar, the chain is snug, and it can be turned by hand without binding.

- Fully tighten the chain cover lock knob by rotating it clockwise to secure. Retension the chain whenever the flats on the drive links hang out of the bar groove.

NOTE: During normal saw operation, the temperature of the chain increases. The drive links of a correctly tensioned warm chain will hang approximately 1/16 in. (1.3 mm) out of the bar groove.

NOTE: New chains tend to stretch. Check the chain tension frequently and tension as required.

⚠ CAUTION! A chain tensioned while warm may be too tight upon cooling. Check the "cold tension" before next use.

GUIDE BAR MAINTENANCE

Most guide bar problems can be prevented merely by keeping the product well maintained. Incorrect filing and non-standard cutter and depth gauge settings are the causes of most guide bar problems, primarily resulting in uneven bar wear.

As the bar wears unevenly, the rails widen, which may cause the chain to clatter and make it difficult to complete straight cuts. If the guide bar is insufficiently lubricated and the product is operated with a saw chain which is too tight, this will contribute to rapid bar wear. To help minimize bar wear, maintenance of the guide bar as well as the saw chain is recommended.

CARE AND MAINTENANCE

- Disassemble the guide bar and saw chain in reversed order from assembly.

- Check the oiling port for clogging and clean if necessary to ensure proper lubrication of the guide bar and saw chain during operation. Insert a soft wire small enough to fit into the oiling port to clean it out. (Fig. 38)

NOTE: The condition of the oil passages can be easily checked. If the passages are clear, the chain will automatically give off a spray of oil within seconds of the product starting. Your product is equipped with an automatic oiling system.

- Check the drive sprocket. If it is worn or damaged due to strain, have it replaced by a qualified service center.

- Clear residue from the rails on the guide bar using a screwdriver, putty knife, wire brush or other similar tool. This will keep the oil passages open to provide proper lubrication to the bar and chain. (Fig. 39)

- Check the guide bar 'rail' for wear: Hold a ruler (straight edge) against the side of the guide bar and 'cutter side plates'. If there is a gap between the ruler and guide bar the guide bar 'rail' is normal. If there is no gap (ruler flush against the side of the guide bar) the guide bar 'rail' is worn and needs to be replaced with a new one of the same type. (Fig. 40)

- Reverse the guide bar from time to time to allow for even wear, which will extend the life span of the bar. Loosen the screw and remove the tension disc from the guide bar. Loosen the screw and remove the tension disc from the guide bar.

- Ensure the rubber washer on the screw is free of wear. Turn the guide bar and fix the tension disc with the screw. Apply a drop of suitable glue to the screw to ensure its safe positioning when reassembled. (Fig. 41)

CHAIN MAINTENANCE

Know your saw chain (See Figure 42-43, page xi)

Use only a recommended low-kickback chain on this saw. This fast-cutting chain provides kickback reduction when properly maintained. For smooth and fast cutting, maintain the chain properly. The chain requires sharpening when the wood chips are small and powdery, the chain must be forced through the wood during cutting, or the chain cuts to one side. During maintenance of the chain, consider the following:

- Improper filing angle of the side plate (Fig. 43) can increase the risk of severe kickback.

- Depth gauge setting (Fig. 45):

- Cutting edges worn too low increases the potential for kickback.

- Cutting edges not low enough decreases cutting ability.

- If the chain cutters hit hard objects such as nails and stones, or are abraded by mud or sand on the wood, take the saw to a qualified pole saw service center to have the chain sharpened. Use only identical parts as listed in this manual.

NOTE: Inspect the drive sprocket for wear or damage when replacing the chain. If signs of wear or damage are present in the areas indicated, take the saw to a qualified pole saw service center to have the sprocket replaced. Use only identical parts as listed in this manual.

Check the saw chain for possible wear and damages. Replace it with a new one if required. Experienced users can sharpen a dull saw chain (see section "Saw chain sharpening" below). Refit the saw chain and the guide bar as described in Replacing the Guide Bar and Chain section.

NOTE: If you do not fully understand the correct procedure for sharpening the chain after reading the instructions that follow, have the saw chain sharpened by a qualified pole saw service center or replaced with a recommended low-kickback chain.

CARE AND MAINTENANCE

SAW CHAIN SHARPENING

Have your chain sharpened professionally at a qualified service center, or sharpen the chain yourself by using a proper sharpening kit. Also observe the sharpening instructions supplied with the sharpening kit.

The height difference between the cutting tip and the ridge is the depth gauge setting. (Fig. 45)

When you sharpen the cutting tip, the depth gauge setting between the tip and the side plate ridge will decrease. To maintain optimal cutting performance the ridge has to be filed down to achieve the recommended depth gauge setting.

TO SHARPEN THE CHAIN, PROCEED AS FOLLOWS:

- Use protective gloves.
- Ensure the chain is correctly tensioned on the guide bar.
- Use a round file, whose diameter is 1.1 times the cutting tooth depth. Make sure 20% of the file diameter is above the cutter's top plate (See Fig. 44 and 45).

NOTE: A file guide is available from most chainsaw retailers and is the easiest way to hold the file at the correct position.

- File at an angle perpendicular to the bar, and at an angle of 25° to the direction of travel. (Fig. 44)
- File each tooth from the inside towards outside only. File one side of the chain first then turn the saw around and repeat the process.
- Sharpen each tooth equally by using the same number of strokes.
- Keep all cutter lengths equal (See Fig. 45). Each time the cutting tip is sharpened the cutting length is reduced. When the cutter length is reduced to 0.16 inch (4 mm) the chain is worn out and should be replaced.

- The depth gauge setting is also reduced with each sharpening. Every 5 sharpenings use a depth gauge measuring tool to check the height between the cutting tip and the ridge (see Fig. 45). When necessary use a flat file to file down the ridge to achieve the .025 inch depth gauge setting. Depth gauge measuring tools are available from most chainsaw retailers.

- If the saw is not functioning properly, take it to a qualified chainsaw service center to have saw inspected for possible repair. Use only identical parts as listed in this manual.

STORAGE

- Store the product and its accessories in a dry, frost-free place. The ideal storage temperature is between 50°F and 80°F.
- Always store the product in a place that is inaccessible to children.
- We recommend using the original package for storage or covering the product with a suitable cloth or enclosure to protect it against dust.

TRANSPORTATION

- Switch the product off and remove the battery pack before transporting it anywhere.
- Attach the blade cover to the saw blade. Attach other transportation guards, if applicable.
- Always carry the product by its gripping handles.
- Protect the product from any heavy impact or strong vibrations which may occur during transportation in vehicles.
- Secure the product to prevent it from slipping or falling over.

ENVIRONMENTALLY SAFE BATTERY DISPOSAL



The following toxic and corrosive materials are in the batteries used in this battery pack:

Lithium-Ion, a toxic material.

⚠ WARNING! All toxic materials must be disposed of in a specified manner to prevent contamination of the environment. Before disposing of damaged or worn out Lithium-Ion battery packs, contact your local waste disposal agency, or the local Environmental Protection Agency for information and specific instructions.

⚠ WARNING! If the battery pack cracks or breaks, with or without leaks, do not recharge it and do not use. Dispose of it and replace with a new battery pack.

DO NOT ATTEMPT TO REPAIR IT!

To avoid injury and risk of fire, explosion, or electric shock, and to avoid damage to the environment:

- Cover the battery terminals with heavy-duty adhesive tape.
- DO NOT attempt to remove or destroy any of the battery pack components.
- DO NOT attempt to open the battery pack.
- If a leak develops, the released electrolytes are corrosive and toxic. DO NOT get the solution in the eyes or on skin, and do not swallow it.
- DO NOT place these batteries in your regular household trash.
- DO NOT incinerate.
- DO NOT place batteries where they will become part of any waste landfill or municipal solid waste stream.
- Take batteries to a certified recycling or disposal center.

TROUBLESHOOTING

PROBLEM	POSSIBLE CAUSE	SOLUTION
Product does not start	1. Battery pack not properly attached	1. Attach properly
	2. Battery pack discharged	2. Remove and charge battery pack
	3. Battery pack damaged	3. Replace with an identical one
	4. Other electrical defect to the product	4. Have product checked by a qualified service center
Product does not reach full power	1. Battery pack capacity too low	1. Charge battery pack
	2. Air vents are blocked	2. Clean the air vents
Unsatisfactory result	1. Saw chain not tensioned properly	1. Tension properly
	2. Dull saw chain	2. Sharpen or replace the saw chain
Excessive vibration/noise or exhaust	1. Saw chain is dull or damaged	1. Sharpen or replace the saw chain
	2. Bolts/nuts are loosen	2. Tighten bolts/nuts
	3. Oil is incorrect	3. Empty out unused oil and refill with the correct oil
Product runs hot, smoke comes off	1. Chain oil reservoir empty	1. Refill with the correct oil
	2. Chain tension too tight	2. Adjust the chain tension
Chain is not rotating but motor runs	1. Chain tension too loose	1. Adjust the chain tension
	2. Guide bar or saw chain damaged	2. Replace with new parts
	3. Chain oil reservoir empty	3. Refill with the correct oil
Motor runs, chain rotates but does not cut	1. Dull chain	1. Sharpen chain
	2. Chain on backwards	2. Reverse direction of chain

CRAFTSMAN 24V MAX* LITHIUM-ION CORDLESS POLE SAW – MODEL NUMBER 151.74326

CRAFTSMAN 24V MAX* LITHIUM-ION CORDLESS POLE SAW – MODEL NUMBER 151.74926

The model number will be found on a label attached to the motor housing.

TO PURCHASE REPLACEMENT PARTS, CALL 1-888-331-4569

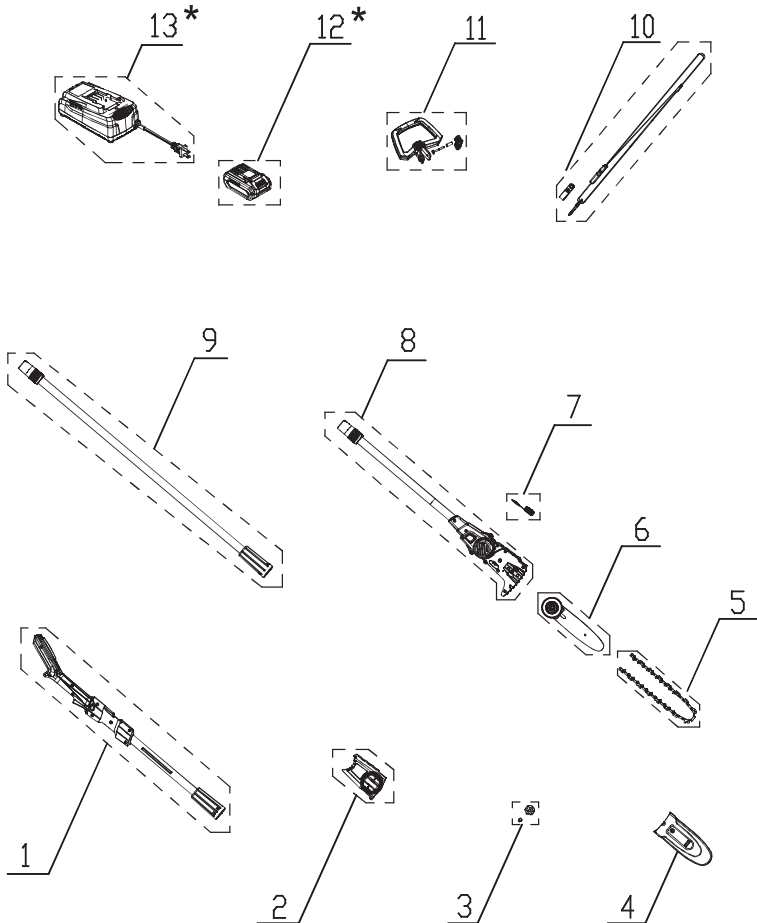

* - Parts #12 & #13 NOT INCLUDED in item # 151.74926

CRAFTSMAN 24V MAX* LITHIUM-ION CORDLESS POLE SAW – MODEL NUMBER 151.74326

CRAFTSMAN 24V MAX* LITHIUM-ION CORDLESS POLE SAW – MODEL NUMBER 151.74926

The model number will be found on a label attached to the motor housing.

TO PURCHASE REPLACEMENT PARTS, CALL 1-888-331-4569

ITEM NO.	PART NO.	DESCRIPTION	QTY
1	261009101	Main Handle Assembly	1
2	261009102	Tool-Free Housing Assembly	1
3	261001121	Chain Wheel Assembly	1
4	261002104	Scabbard	1
5	261002105	Chain	1
6	261009103	Guide Bar with Tensioning Sprocket	1
7	261009104	Oil Reservoir Cap	1
8	261009105	Motor Assembly	1
9	261009106	Pole Extension	1
10	261009111	Shoulder Strap Assembly (incl connector)	1
11	261009109	Assist Handle Assembly (incl Cam lock)	1
12	71.98724	24V Lithium-Ion Battery (24LB2513) * (NOT INCLUDED in item # 151.74926)	1
13	24LFC14-ETL	24V Lithium-Ion Battery Charger (24LFC14-ETL) * (NOT INCLUDED in item # 151.74926)	1

* - Parts #12 & #13 NOT INCLUDED in item # 151.74926

See this section for all of the figures referenced in the operator's manual.

Consulte esta sección para ver todas las figuras mencionadas en el manual del usuario.

Fig. 1

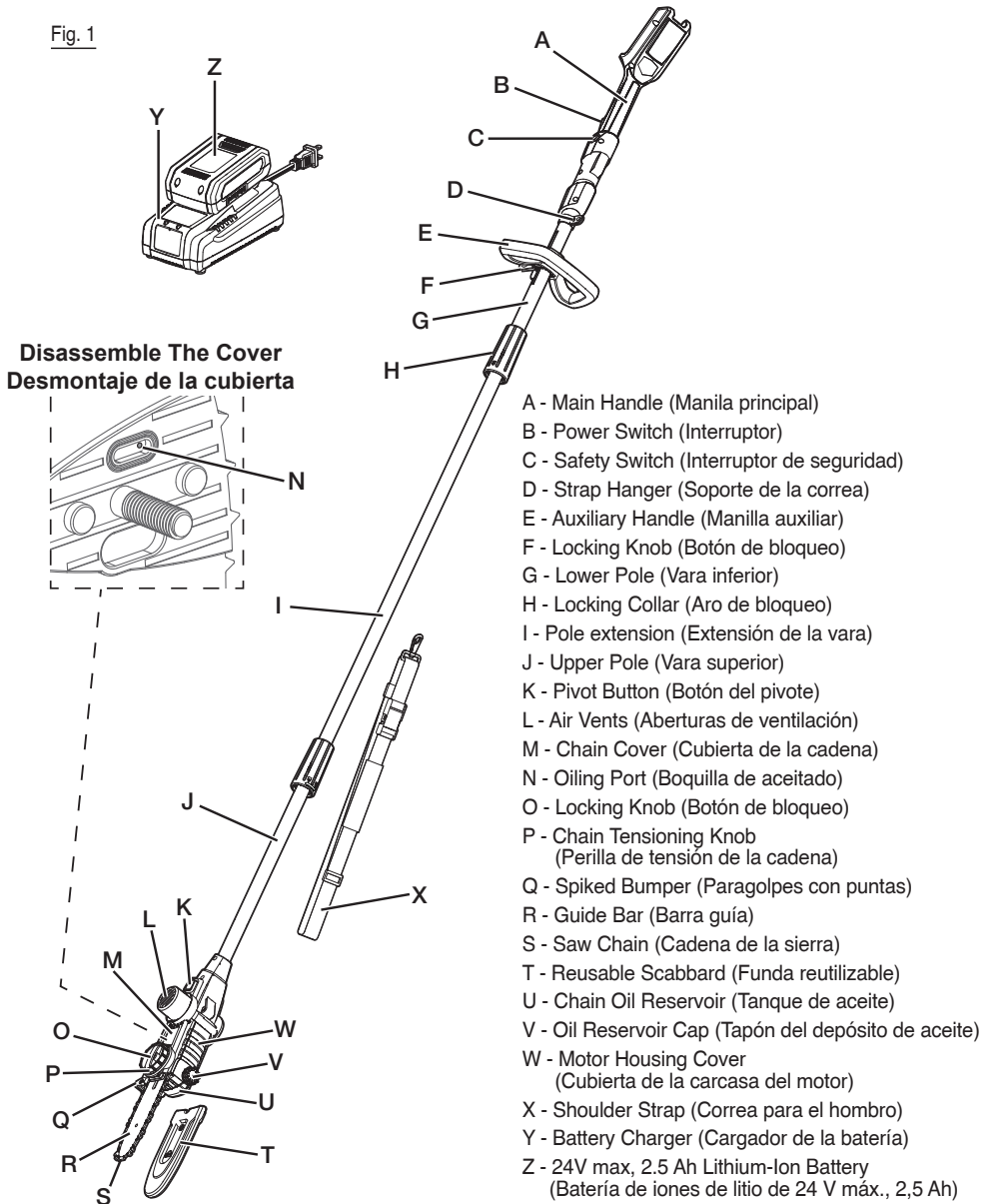
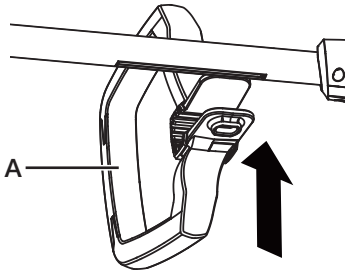
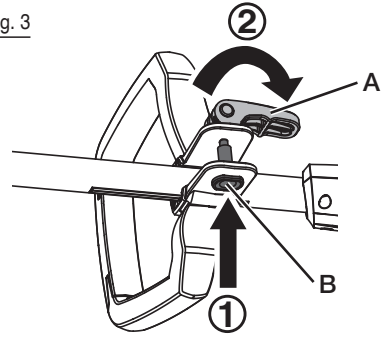

Fig. 2



A - Auxiliary Handle (Manilla auxiliar)

Fig. 3



A - Locking Knob (Botón de bloqueo)
B - Bolt (Perno)

Fig. 4

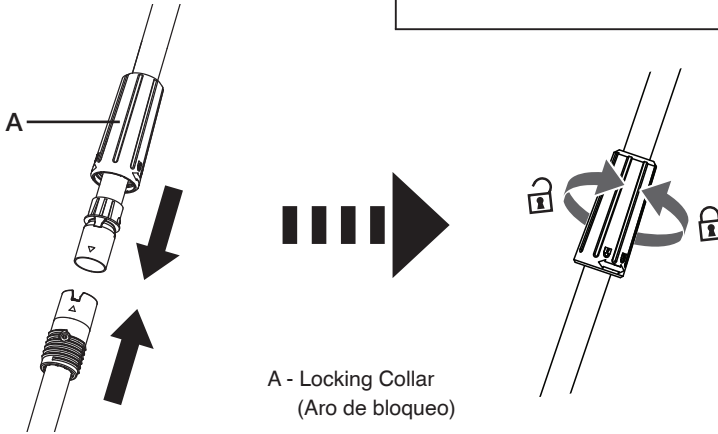

A - Locking Collar
(Aro de bloqueo)

Fig. 5

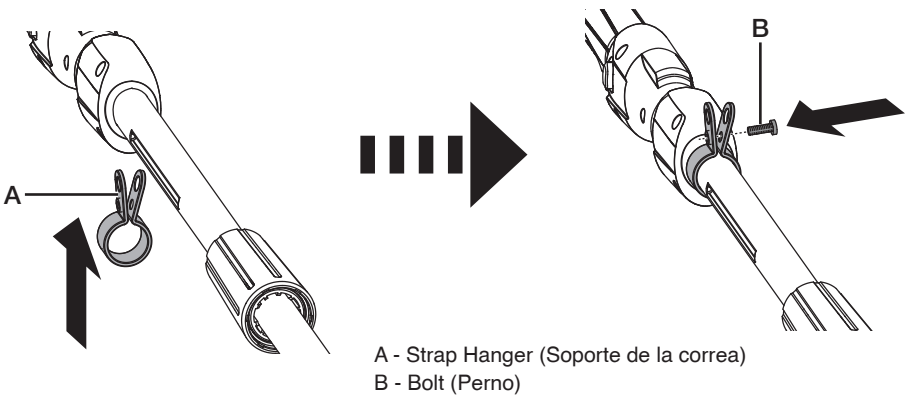

A - Strap Hanger (Soporte de la correa)
B - Bolt (Perno)

Fig. 6

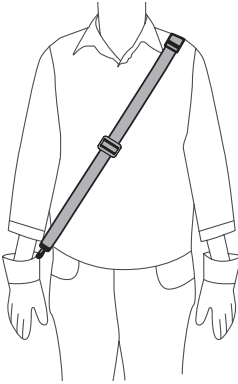

Fig. 7

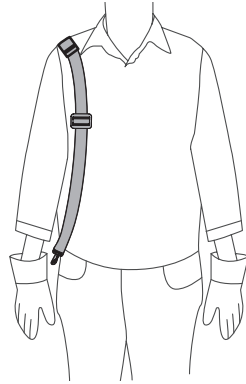

Fig. 8

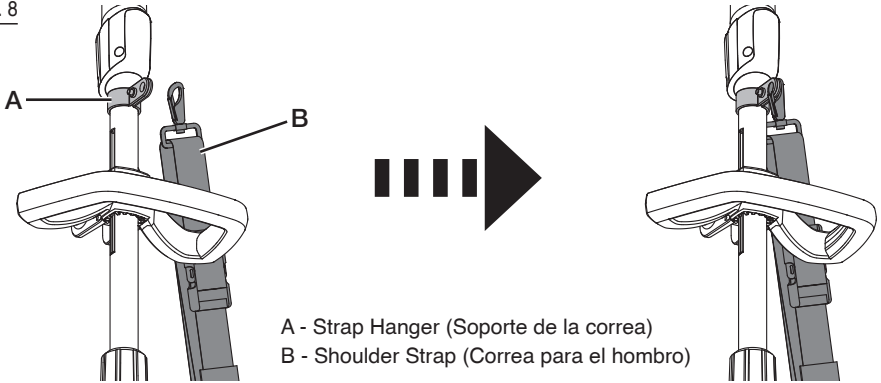
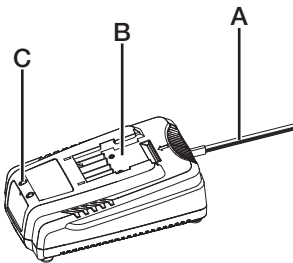

Fig. 9



- A - Power Cord with Plug (Cable de corriente con enchufe)
- B - Charger (Cargador)
- C - Indicator Lights (Luces indicadoras)

Fig. 10

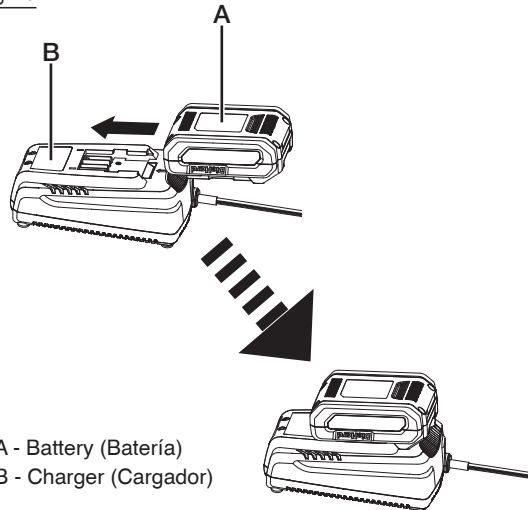

Fig. 11

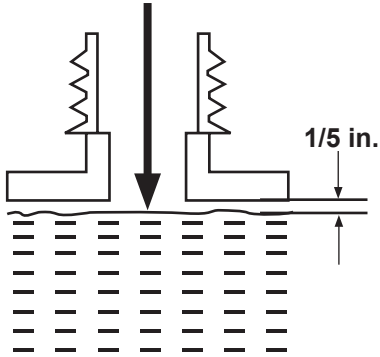
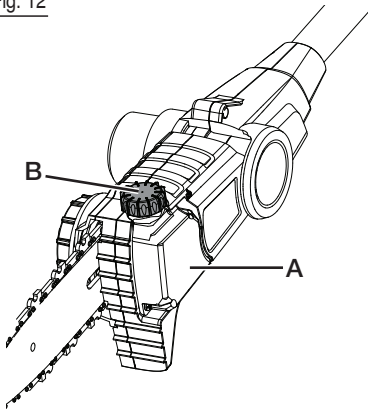

Fig. 12



A - Chain Oil Reservoir (Tanque de aceite)
B - Oil Reservoir Cap (Tapón del depósito de aceite)

Fig. 13

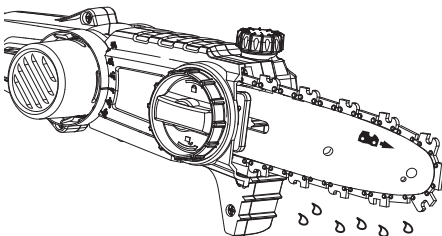
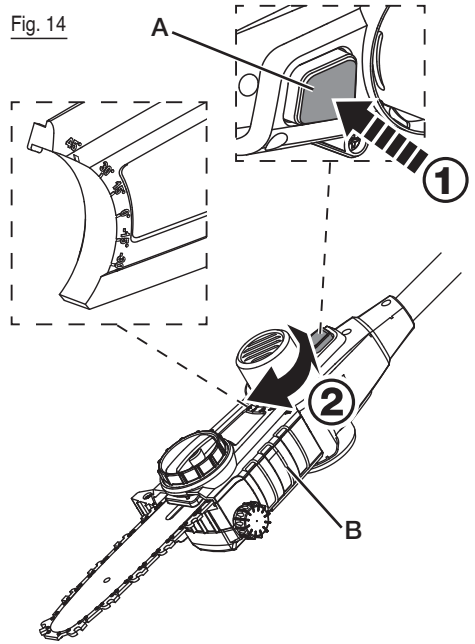

Fig. 14



A - Pivot Button (Botón del pivote)
B - Cutting Head (Cabezal de corte)

Fig. 15

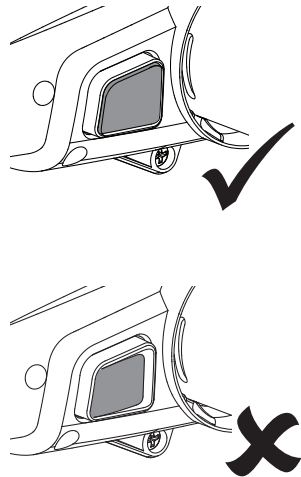

Fig. 16

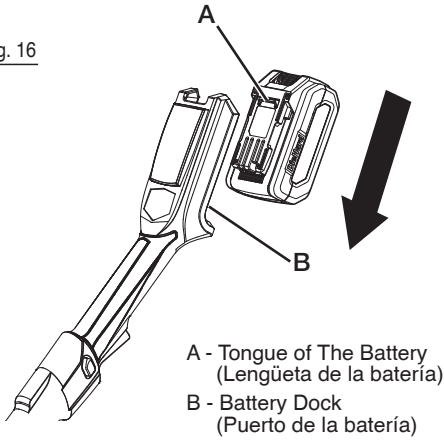

Fig. 17

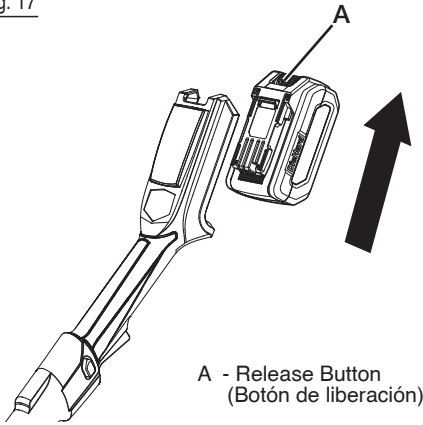

Fig. 18

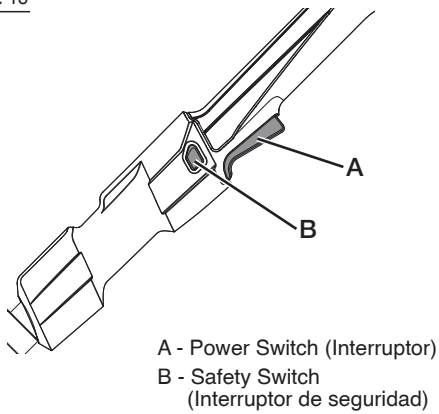

Fig. 19

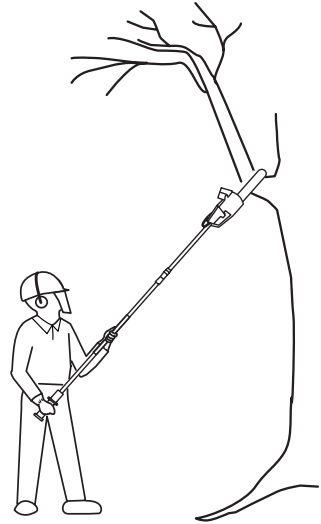

Fig. 20

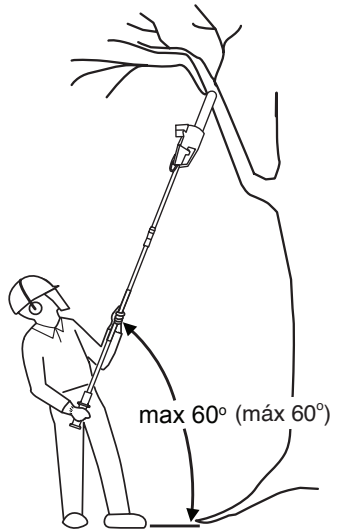

Fig. 21

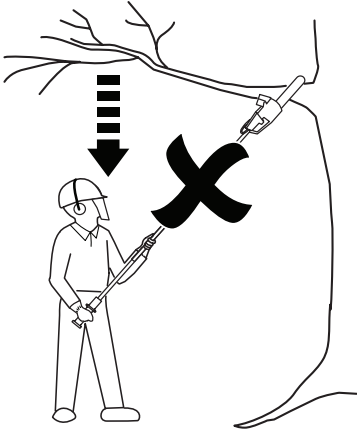

Fig. 23

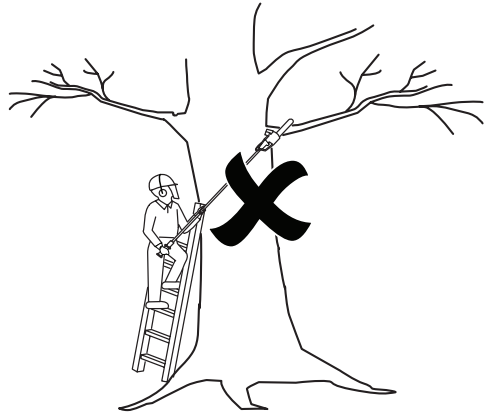

Fig. 22

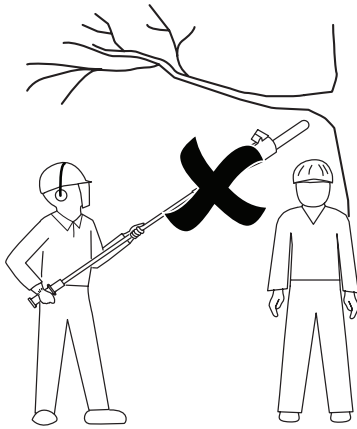

Fig. 24

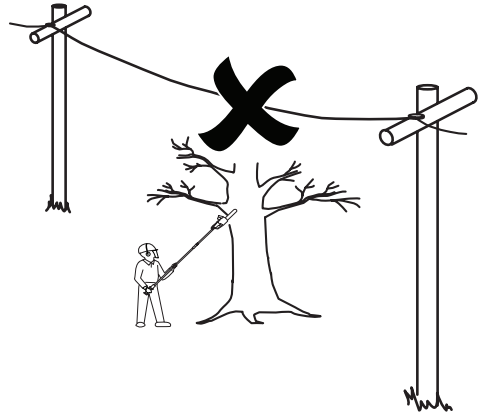

Fig. 25



Fig. 26

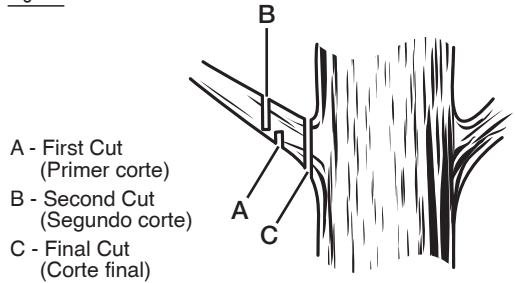
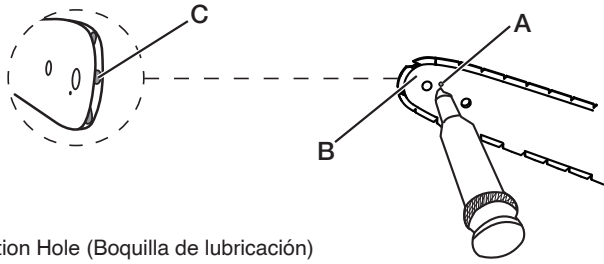
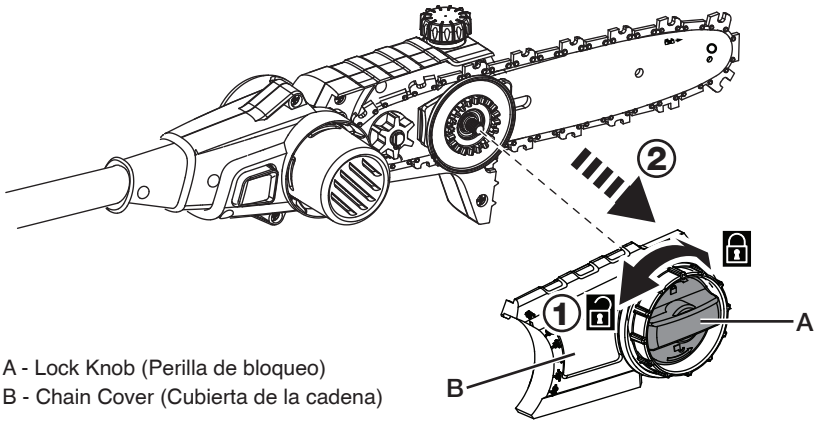

Fig. 27



- A - Lubrication Hole (Boquilla de lubricación)
- B - Bar Nose (Nariz de la barra)
- C - Sprocket (Rueda de cadena)

Fig. 28



- A - Lock Knob (Perilla de bloqueo)
- B - Chain Cover (Cubierta de la cadena)

Fig. 29

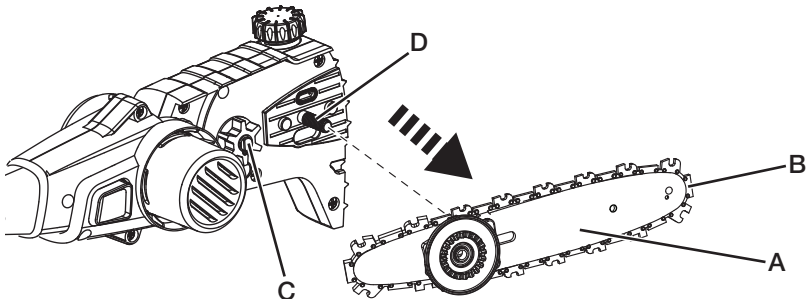

- A - Guide Bar (Barra guía)
- B - Saw Chain (Cadena de la sierra)
- C - Drive Sprocket (Rueda de cadena motriz)
- D - Support Bolt (Perno de soporte)

Fig. 30

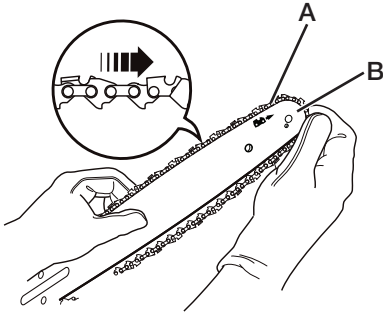

A - Saw Chain (Cadena de la sierra)
B - Guide Bar (Barra guía)

Fig. 31

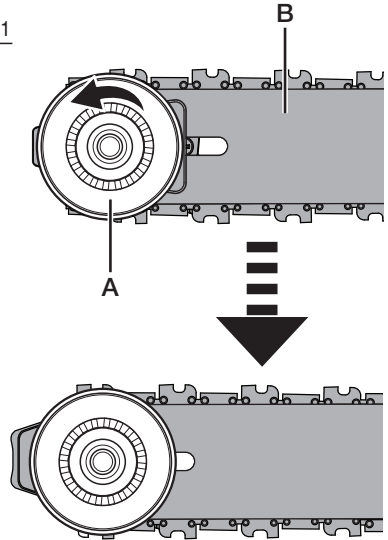

A - Tension Disc (Disco de tensión)
B - Guide Bar (Barra guía)

Fig. 32

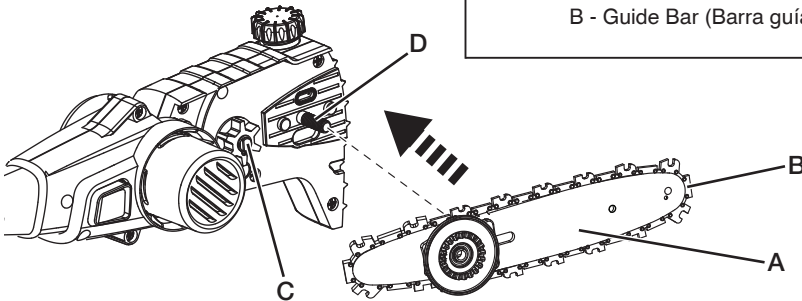

A - Guide Bar (Barra guía)
B - Saw Chain (Cadena de la sierra)
C - Drive Sprocket (Rueda de cadena motriz)
D - Support Bolt (Perno de soporte)

Fig. 33

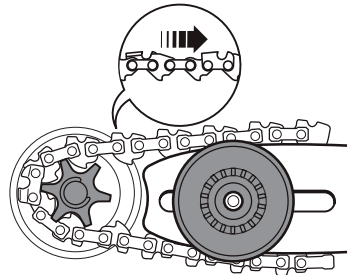
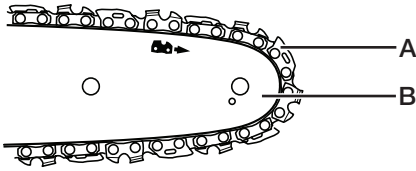
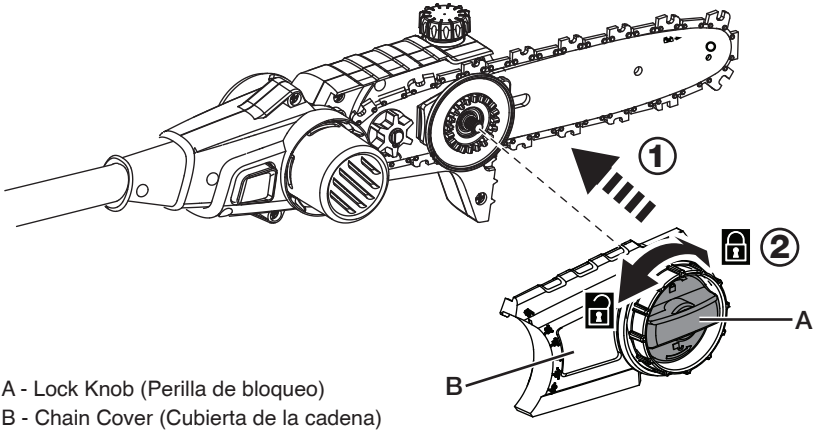

Fig. 34



A - Saw Chain (Cadena de la sierra)
B - Guide Bar (Barra guía)

Fig. 35



A - Lock Knob (Perilla de bloqueo)
B - Chain Cover (Cubierta de la cadena)

Fig. 36

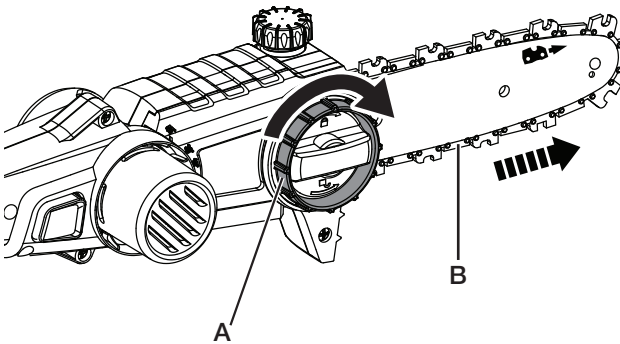

A - Chain Tensioning Knob (Perilla de tensión de la cadena)
B - Tie Strap (Correa de amarre)

Fig. 37

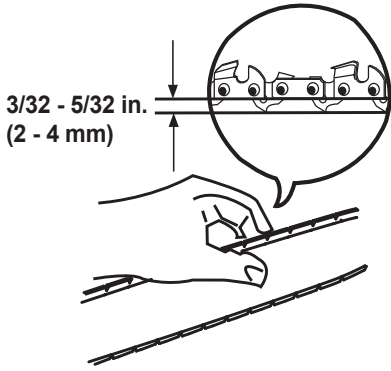

Fig. 39

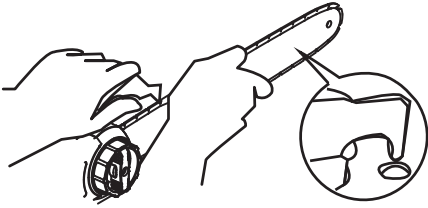

Fig. 40

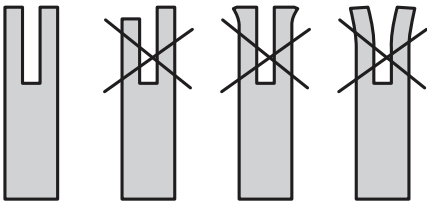
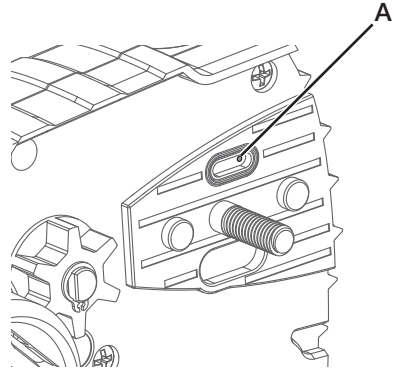
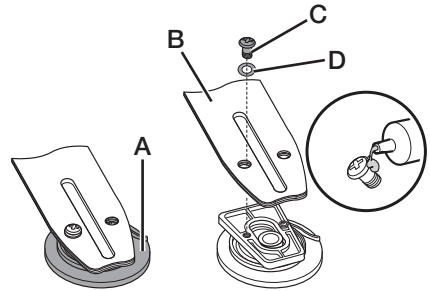

Fig. 38



A - Oiling Port (Boquilla de aceiteado)

Fig. 41



A - Tension Disc (Disco de tensión)
 B - Guide Bar (Barra guía)
 C - Screw (Tornillo)
 D - Rubber Washer (Arandela de Goma)

Fig. 42

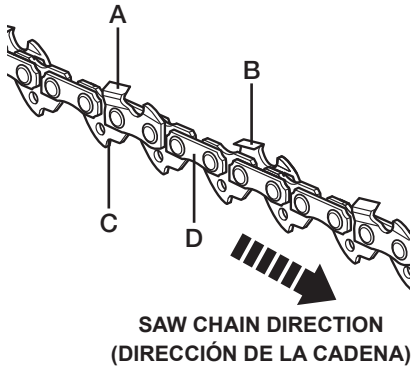

- A - Right-hand Cutter (Cortador de la derecha)
- B - Left-hand Cutter (Cortador de la izquierda)
- C - Bumper Drive Link (Eslabón motriz de defensa)
- D - Tie Strap (Correa de amarre)

Fig. 44

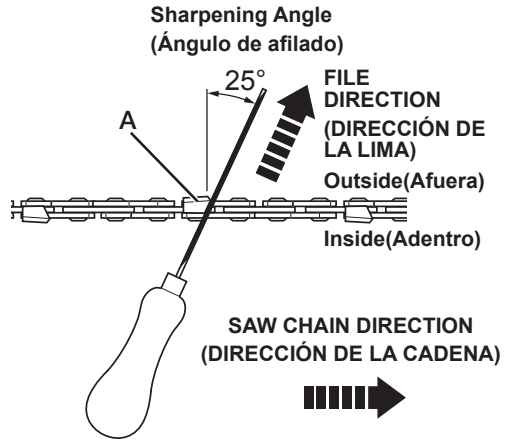

- A - Left-hand Cutter (Cortador de la izquierda)

Fig. 43

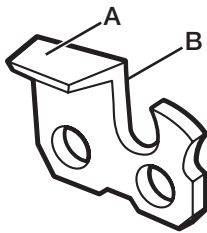

- A - Top Plate (Placa superior)
- B - Side Plate (Placa lateral)

Fig. 45

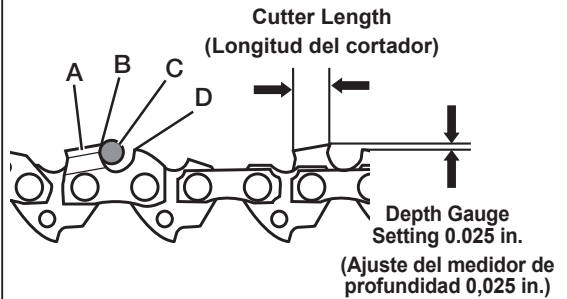

- A - Top Plate (Placa superior)
- B - Cutting Tip (Punta de corte)
- C - File Position (Posición de la lima)
- D - Ridge (Cima)

CRAFTSMAN®

Product questions or problems?

1-888-331-4569

Customer Care Hot Line

**Get answers to questions, troubleshoot problems,
order parts, or schedule repair service.**

Para respuestas a preguntas o problemas, y ordenar
piezas o pedir servicio para la reparación de su equipo.

To help us help you, register your product at www.craftsman.com/registration

Para poderte ayudar mejor, registra tu producto en www.craftsman.com/registration

Join the Craftsman Club today!

CRAFTSMAN® CLUB

www.craftsman.com/signup

**Receive exclusive member benefits including special pricing and offers,
project sharing, expert advice, and SHOP YOUR WAY REWARDS!**

Como miembro exclusivo, recibe diversos beneficios como ofertas, precios especiales, proyectos nuevos, consejos de expertos y nuestro programa de puntos SHOP YOUR WAY REWARDS!

® Registered Trademark / ™ Trademark of KCD IP, LLC in the United States, or Sears Brands, LLC in other countries

® Marca Registrada / ™ Marca de Fábrica de KCD IP, LLC en Estados Unidos, o Sears Brands, LLC in otros países