

DENON

AVR-1613

INTEGRATED NETWORK AV RECEIVER

Owner's Manual

Basic version

Advanced version

Information

SAFETY PRECAUTIONS



CAUTION
RISK OF ELECTRIC SHOCK
DO NOT OPEN



CAUTION:
TO REDUCE THE RISK OF ELECTRIC SHOCK, DO NOT REMOVE COVER (OR BACK). NO USER-SERVICEABLE PARTS INSIDE. REFER SERVICING TO QUALIFIED SERVICE PERSONNEL.

The lightning flash with arrowhead symbol, within an equilateral triangle, is intended to alert the user to the presence of uninsulated "dangerous voltage" within the product's enclosure that may be of sufficient magnitude to constitute a risk of electric shock to persons.

The exclamation point within an equilateral triangle is intended to alert the user to the presence of important operating and maintenance (servicing) instructions in the literature accompanying the appliance.

WARNING:
TO REDUCE THE RISK OF FIRE OR ELECTRIC SHOCK, DO NOT EXPOSE THIS APPLIANCE TO RAIN OR MOISTURE.



Hot surface mark

CAUTION:
HOT SURFACE. DO NOT TOUCH.

The top surface over the internal heat sink may become hot when operating this product continuously. Do not touch hot areas, especially around the "Hot surface mark" and the top panel.

IMPORTANT SAFETY INSTRUCTIONS

1. Read these instructions.
2. Keep these instructions.
3. Heed all warnings.
4. Follow all instructions.
5. Do not use this apparatus near water.
6. Clean only with dry cloth.
7. Do not block any ventilation openings. Install in accordance with the manufacturer's instructions.
8. Do not install near any heat sources such as radiators, heat registers, stoves, or other apparatus (including amplifiers) that produce heat.
9. Do not defeat the safety purpose of the polarized or grounding-type plug. A polarized plug has two blades with one wider than the other. A grounding type plug has two blades and a third grounding prong. The wide blade or the third prong are provided for your safety. If the provided plug does not fit into your outlet, consult an electrician for replacement of the obsolete outlet.
10. Protect the power cord from being walked on or pinched particularly at plugs, convenience receptacles, and the point where they exit from the apparatus.
11. Only use attachments/accessories specified by the manufacturer.
12. Use only with the cart, stand, tripod, bracket, or table specified by the manufacturer, or sold with the apparatus. When a cart is used, use caution when moving the cart/apparatus combination to avoid injury from tip-over.
13. Unplug this apparatus during lightning storms or when unused for long periods of time.
14. Refer all servicing to qualified service personnel. Servicing is required when the apparatus has been damaged in any way, such as power-supply cord or plug is damaged, liquid has been spilled or objects have fallen into the apparatus, the apparatus has been exposed to rain or moisture, does not operate normally, or has been dropped.
15. Batteries shall not be exposed to excessive heat such as sunshine, fire or the like.



CAUTION:

To completely disconnect this product from the mains, disconnect the plug from the wall socket outlet. The mains plug is used to completely interrupt the power supply to the unit and must be within easy access by the user.

FCC INFORMATION (For US customers)

1. COMPLIANCE INFORMATION

Product Name: Integrated Network AV Receiver

Model Number: AVR-1613

This product complies with Part 15 of the FCC Rules. Operation is subject to the following two conditions: (1) this product may not cause harmful interference, and (2) this product must accept any interference received, including interference that may cause undesired operation.

Denon Electronics (USA), LLC

(a D&M Holdings Company)

100 Corporate Drive

Mahwah, NJ 07430-2041

Tel. (201) 762-6665

2. IMPORTANT NOTICE: DO NOT MODIFY THIS PRODUCT

This product, when installed as indicated in the instructions contained in this manual, meets FCC requirements. Modification not expressly approved by DENON may void your authority, granted by the FCC, to use the product.

3. IMPORTANT

When connecting this product to network hub or router, use only a shielded STP or ScTP LAN cable which is available at retailer.

Follow all installation instructions. Failure to follow instructions could void your authority, granted by the FCC, to use the product.

4. NOTE

This product has been tested and found to comply with the limits for a Class B digital device, pursuant to Part 15 of the FCC Rules. These limits are designed to provide reasonable protection against harmful interference in a residential installation.

This product generates, uses and can radiate radio frequency energy and, if not installed and used in accordance with the instructions, may cause harmful interference to radio communications. However, there is no guarantee that interference will not occur in a particular installation. If this product does cause harmful interference to radio or television reception, which can be determined by turning the product OFF and ON, the user is encouraged to try to correct the interference by one or more of the following measures:

- Reorient or relocate the receiving antenna.
- Increase the separation between the equipment and receiver.
- Connect the product into an outlet on a circuit different from that to which the receiver is connected.
- Consult the local retailer authorized to distribute this type of product or an experienced radio/TV technician for help.

For Canadian customers:

This Class B digital apparatus complies with Canadian ICES-003.

NOTES ON USE

WARNINGS

- Avoid high temperatures.
Allow for sufficient heat dispersion when installed in a rack.
- Handle the power cord carefully.
Hold the plug when unplugging the cord.
- Keep the unit free from moisture, water, and dust.
- Unplug the power cord when not using the unit for long periods of time.
- Do not obstruct the ventilation holes.
- Do not let foreign objects into the unit.
- Do not let insecticides, benzene, and thinner come in contact with the unit.
- Never disassemble or modify the unit in any way.
- Ventilation should not be impeded by covering the ventilation openings with items, such as newspapers, tablecloths or curtains.
- Naked flame sources such as lighted candles should not be placed on the unit.
- Observe and follow local regulations regarding battery disposal.
- Do not expose the unit to dripping or splashing fluids.
- Do not place objects filled with liquids, such as vases, on the unit.
- Do not handle the mains cord with wet hands.
- When the switch is in the OFF (STANDBY) position, the equipment is not completely switched off from MAINS.
- The equipment shall be installed near the power supply so that the power supply is easily accessible.

CAUTIONS ON INSTALLATION

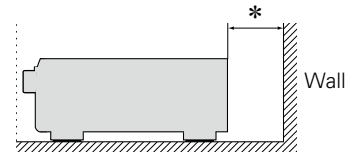
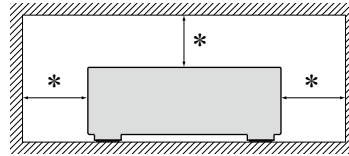

*** For proper heat dispersal, do not install this unit in a confined space, such as a bookcase or similar enclosure.**

- More than 12 in. (0.3 m) is recommended.
- Do not place any other equipment on this unit.

Getting started

Thank you for purchasing this DENON product. To ensure proper operation, please read this owner's manual carefully before using the product. After reading them, be sure to keep them for future reference.

Contents

Getting started	1
Accessories	2
Features	2
Cautions on handling	3
Basic version	4
Connections	5
Important information	5
Connecting an HDMI-compatible device	7
Connecting an HDMI-incompatible device	12
Connecting to a home network (LAN)	18
Connecting the power cord	19
Settings	20
Set up speakers (Audyssey® Setup)	20
Making the network settings (Network)	26
Playback (Basic operation)	27
Important information	27
Playing a Blu-ray Disc player/DVD player	28
Playing an iPod	29
Playing a USB memory device	32
Listening to FM broadcasts	35
Network	43
Listening to internet radio	43
Playing back files stored on a PC and NAS	46
Using online services	50
Convenient functions	58
AirPlay function	62
Selecting a listening mode (Sound Mode)	64
Selecting a listening mode	64

Advanced version	68
Installation/connection of speakers (Advanced)	69
Speaker installation	69
Speaker connection	70
Playback (Advanced operation)	73
HDMI control function	73
Sleep timer function	74
Quick select function	75
Various memory functions	75
How to make detailed settings	76
Menu map	76
Examples of menu screen displays	77
Examples of menu and front display	78
Inputting characters	79
Audio	80
Video	86
Inputs	89
Speakers	93
Network	97
General	101

Information	106
Part names and functions	107
Front panel	107
Display	108
Rear panel	109
Remote control unit	110
Other information	112
Trademark information	112
Surround	113
Relationship between video signals and monitor output	116
Explanation of terms	117
Troubleshooting	119
Resetting the microprocessor	123
Specifications	124

Accessories

Check that the following parts are supplied with the product.

① Getting Started	1
② CD-ROM (Owner's manual)	1
③ Warranty (for North America model only).....	1
④ Service network list.....	1
⑤ Remote control unit (RC-1169).....	1
⑥ R03/AAA batteries.....	2
⑦ Setup microphone (ACM1HB).....	1
⑧ FM indoor antenna	1

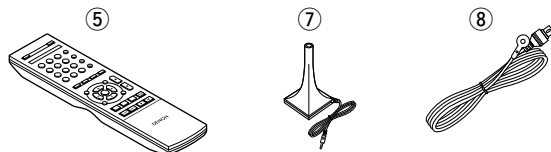

Features

With a discrete-circuit configuration, the power amplifier provides identical quality for all 5 channels (120 W x 5ch)

The unit is equipped with a power amplifier that reproduces highfidelity sound in sound mode with equal quality and power for all channels, true to the original sound.

The power amplifier circuit adopts a discrete-circuit configuration that achieves high-quality surround sound reproduction.

Supports internet radio, music, and photograph streaming

Supports AirPlay® (👉 page 62)

You can enjoy a wide variety of content, including listening to Internet radio, playing the audio files stored on your PC, and displaying on a TV the photographs stored on your PC.

This unit also supports AirPlay that lets you stream your music library from an iPhone, iPad, iPod touch or iTunes.

Compatible with “Denon Remote App” for performing basic operations of the unit with an iPad, iPhone or Android smartphone*1

“Denon Remote App” is application software that allows you to perform basic operations with an iPad, iPhone, Android smartphone or Android tablet such as turning the unit ON/OFF, controlling the volume, and switching the source.

*1 Download “Denon Remote App” from iTunes® App Store. The unit needs to be connected to a LAN and the iPhone/iPod touch needs to be connected to the same network by Wi-Fi (wireless LAN).

“Setup Assistant”, providing easy-to-follow setup instructions

First select the language when prompted. Then simply follow the instructions displayed on the TV screen to set up the speakers, network, etc.

Easy to use, Graphical User Interface

This unit is equipped with an easy to see “Graphical User Interface” that uses menu displays and levels. The use of level displays increases operability of the this unit.

HDMI connectors enable connection to various digital AV devices (input: 5, output: 1)

The unit is equipped with 5 HDMI input connectors for connecting devices with HDMI connectors, such as a Blu-ray Disc player, game machine, etc.

Supports HDMI (3D, ARC, Deep Color, “x.v.Color”, Auto Lip Sync) and HDMI control function (👉 page 7)

This unit can output 3D video signals input from a Blu-ray Disc player to a TV that supports a 3D system. This unit also supports the ARC (Audio Return Channel) function, which reproduces TV sound with this unit via an HDMI cable used for connecting the unit and a TV*2.

*2 The TV should support the ARC function.

Direct play for iPod® and iPhone® via USB (👉 page 16)

Music data from an iPod can be played back if you connect the USB cable supplied with the iPod via the USB port of this unit, and also an iPod can be controlled with the remote control unit for this unit.

Cautions on handling

- **Before turning the power on**

Check once again that all connections are correct and that there are no problems with the connection cables.

- Power is supplied to some of the circuitry even when the unit is set to the standby mode. When going on vacation or leaving home for long periods of time, be sure to unplug the power cord from the power outlet.

- **About condensation**

If there is a major difference in temperature between the inside of the unit and the surroundings, condensation (dew) may form on the operating parts inside the unit, causing the unit not to operate properly.

If this happens, let the unit sit for an hour or two with the power turned off and wait until there is little difference in temperature before using the unit.

- **Cautions on using mobile phones**

Using a mobile phone near this unit may result in noise. If that occurs, move the mobile phone away from this unit when it is in use.

- **Moving the unit**





Turn off the power and unplug the power cord from the power outlet. Next, disconnect the connection cables to other system units before moving the unit.

- **About care**

- Wipe the cabinet and control panel clean with a soft cloth.
- Follow the instructions when using a chemical cleaner.
- Benzene, paint thinner or other organic solvents as well as insecticide may cause material changes and discoloration if brought into contact with the unit, and should therefore not be used.

Basic version

Here, we explain the connections and basic operation methods for this unit.

- **Connections**  [page 5](#)
- **Settings**  [page 20](#)
- **Playback (Basic operation)**  [page 27](#)
- **Selecting a listening mode (Sound Mode)**  [page 64](#)

Connections

Important information

Make connections before using this unit.

To create a home theater that can play back higher quality video and audio by fully utilizing the capabilities of this unit and your video devices, connect this unit to each of your video devices with HDMI cables.

❑ HDMI-compatible device

If your video device does not support HDMI connections, use the following connection.

❑ HDMI-incompatible device

This unit can change the source that is assigned to the DIGITAL AUDIO IN connectors.

You can change the source for connectors listed in **Input connector setting** within pages that describe connections for devices.

For details on assigning a source to connectors, see “Changing the source assigned to connectors” (page 12). For the setting method, see “Digital Assign” (page 90).

NOTE

- The menu screen is only displayed on TV connected to this unit via HDMI. If your TV is connected to this unit via other video output connectors, perform menu operations while seeing the display on this unit.
- Do not plug in the power cord until all connections have been completed. However, when the “Setup Assistant” is running, follow the instructions in the “Setup Assistant” (page 7) screen for making connections. (During “Setup Assistant” operation, the input/output connectors do not conduct current.)
- When running the “Setup Assistant” (page 7), turn off the power supply of connected devices.
- When making connections, also refer to the operating instructions of the other devices being connected.
- Be sure to connect the left and right channels properly (left with left, right with right).
- Do not bundle power cords together with connection cables. Doing so can result in noise.

❑ HDMI-compatible device



page 8



page 10



page 10



page 10



page 10



page 10

❑ HDMI-incompatible device



page 13



page 14



page 15



page 16



page 17



page 18



page 70



page 19

Relationship between video signals and monitor output

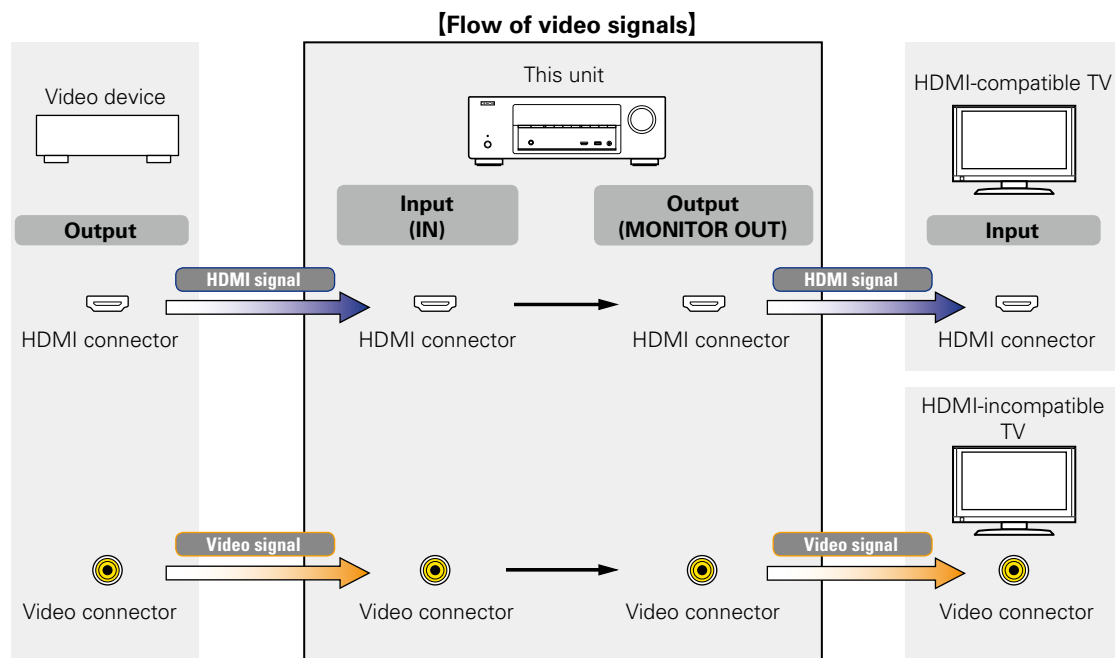

Resolutions of HDMI-compatible TVs can be checked at “Monitor” ([page 103](#)).

NOTE

- **The menu screen is only displayed on TV connected to this unit via HDMI. If your TV is connected to this unit via other video output connectors, perform menu operations while seeing the display on this unit.**
- HDMI signals are digital. HDMI signals cannot be converted into analog signals ([page 116](#)).
- Analog signals cannot be converted into HDMI signals ([page 116](#)).

Connecting an HDMI-compatible device

You can connect up to seven HDMI-compatible devices (5-inputs/1-output) to the unit.

If the device connected to this unit is equipped with an HDMI connector, it is recommended to use HDMI connections. Connections with an HDMI cable offer the following benefits that can not be achieved with other connection methods.

- **High quality playback by transmitting audio and video via digital signals**

HDMI connections can transmit high definition video and high quality audio formats adopted by Blu-ray disc players (Dolby Digital Plus, Dolby TrueHD, dts-HD, dts-HD Master Audio).

HDMI connections also convey information required for playback between devices. The information is used for copyright protection and TV resolution recognition, the ARC function, the HDMI control function, etc.

- **Transmission of audio and video signals with a single HDMI cable**

Previous connections require multiple audio and video cables, but HDMI connections require only a single HDMI cable to transmit audio and video signals. This allows wires in a home theater system, which tend to be complicated, to be more organized.

- **Mutual control through the HDMI control function** (👉 [page 73](#))

This unit and the HDMI device connected via HDMI can be linked to perform operations such as power control, volume control, and input source switching.

- **Other video and audio functions, such as 3D video playback, Content Type, the ARC function, are supported** (👉 [page 11](#)).



- There is more than one version of HDMI standard. The supported functions and the performance vary according to the version. This unit complies with the HDMI standard, supporting the ARC and 3D playback functions. To enjoy these functions, the HDMI device connected to this unit also needs to use the same version of the standard. For the version of the HDMI standard on the device connected to this unit, see the device's manual.
- Some TVs do not support audio input via HDMI connections. For details, see your TV's manual.

❑ **Before connecting this unit to TV via HDMI connections** (👉 [page 8](#))

❑ **Connecting this unit to a TV via HDMI connections** (👉 [page 9](#))

❑ **Connecting this unit to video devices via HDMI connections** (👉 [page 10](#))

❑ **HDMI function** (👉 [page 11](#))

❑ **Settings related to HDMI connections** (👉 [page 11](#))

Before connecting this unit to TV via HDMI connections

There are 2 methods to connect HDMI-compatible TV to this unit.
Use the connection method that suits your TV.

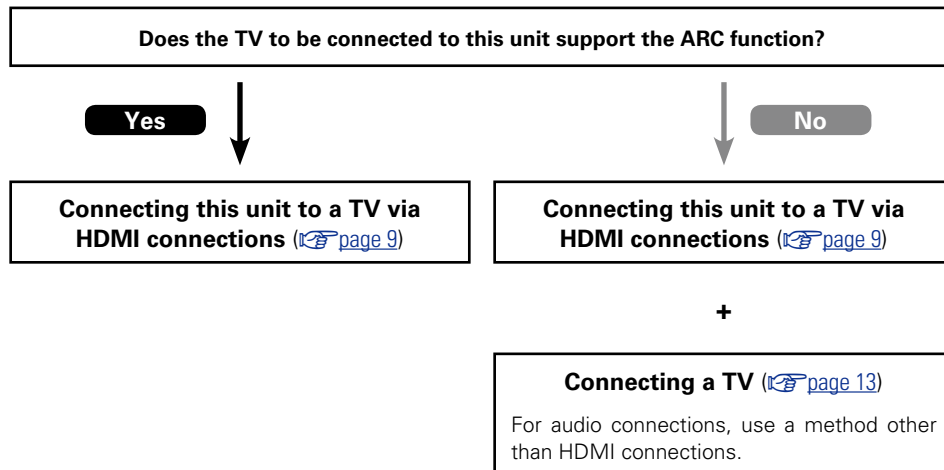

□ About ARC (Audio Return Channel) function

This function plays TV audio on this unit by sending the TV audio signal to this unit via HDMI cable. If a TV without the ARC function is connected via HDMI connections, video signals of the playback device connected to this unit are transmitted to the TV, but this unit can not play back the audio from the TV. If you want to enjoy surround audio for TV program, a separate audio cable connection is required.

In contrast, if a TV with the ARC function is connected via HDMI connections, no audio cable connection is required. Audio signals from the TV can be input to this unit through the HDMI cable between this unit and the TV. This function allows you to enjoy surround playback on this unit for the TV.



When the ARC function is used, connect a device with a “Standard HDMI cable with Ethernet” or “High Speed HDMI cable with Ethernet” for HDMI. Refer to the owner’s manual for your TV for details about TV connection and settings.

[Connection to a TV with the ARC function]

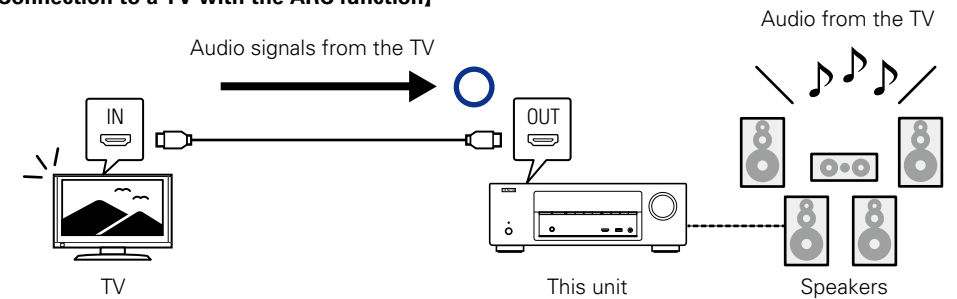

[Connection to a TV without the ARC function]

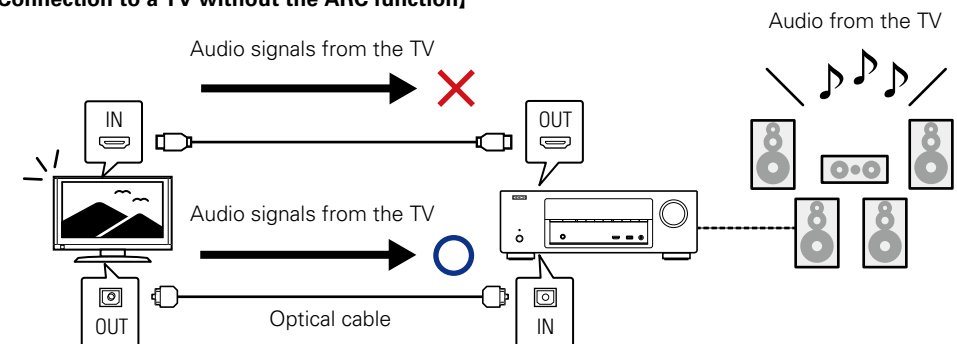

Connecting this unit to a TV via HDMI connections

Cables used for connections

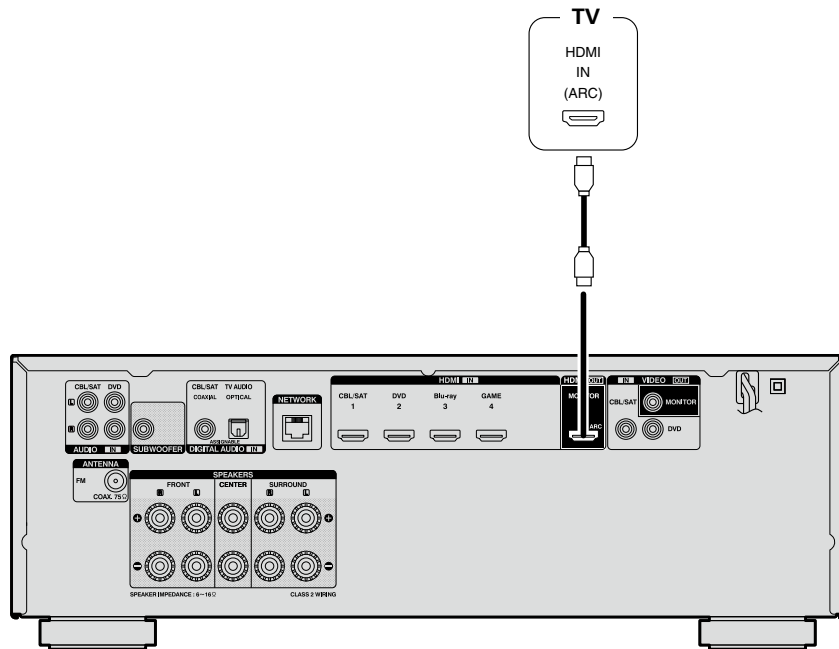
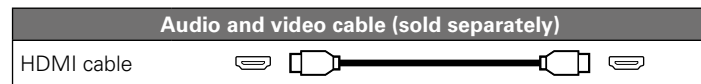

- Video signals are not output if the input video signals do not match the monitor's resolution. In this case, switch the Blu-ray Disc/DVD player's resolution to a resolution with which the monitor is compatible.
- When this unit and monitor are connected with an HDMI cable, if the monitor is not compatible with HDMI audio signal playback, only the video signals are output to the monitor. Make audio connections ([page 13](#) "Connecting a TV").

NOTE

- The audio signal from the HDMI output connector (sampling frequency, number of channels, etc.) may be limited by the HDMI audio specifications of the connected device regarding permissible inputs.
- **When connecting a TV that does not support the ARC function, an audio cable connection is required in addition to the HDMI cable. In this case, refer to "Connecting a TV" ([page 13](#)) for the connection method.**

For the ARC function, see "About ARC (Audio Return Channel) function" ([page 8](#)).

Connecting to a device equipped with a DVI-D connector

The DVI-D (Digital Visual Interface) method is also used for video transmission via digital signals. This is developed mainly for computers, and some AV devices such as projectors are equipped with this interface. To output HDMI video signals to a DVI-D video input compatible device, use an HDMI/DVI conversion cable, which converts HDMI video signals to DVI signals.

The DVI-D connector can transmit high quality digital signals, but the copy guard and other issues may hinder normal operations for some device combinations.

NOTE

- No sound is output when connected to a device equipped with a DVI-D connector. Make audio connections as described in "Connecting a TV" ([page 13](#)).
- Signals cannot be output to DVI-D devices that do not support HDCP.
- Depending on the combination of devices, the video signals may not be output.

Connecting this unit to video devices via HDMI connections

Cables used for connections

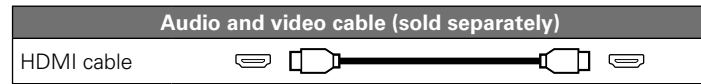

- This interface allows transfer of digital video signals and digital audio signals over a single HDMI cable.

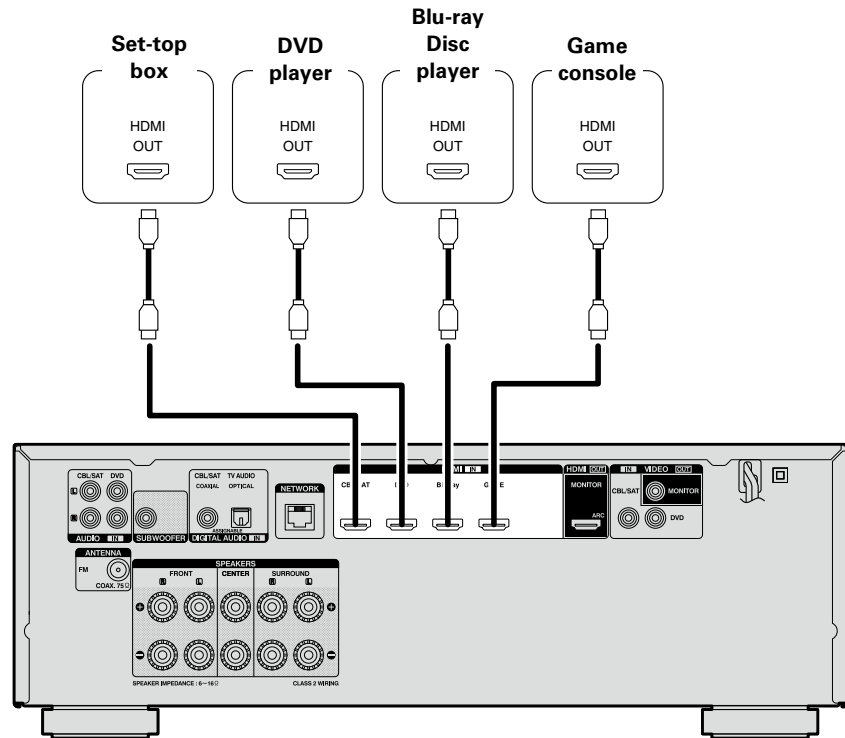

[Rear panel]

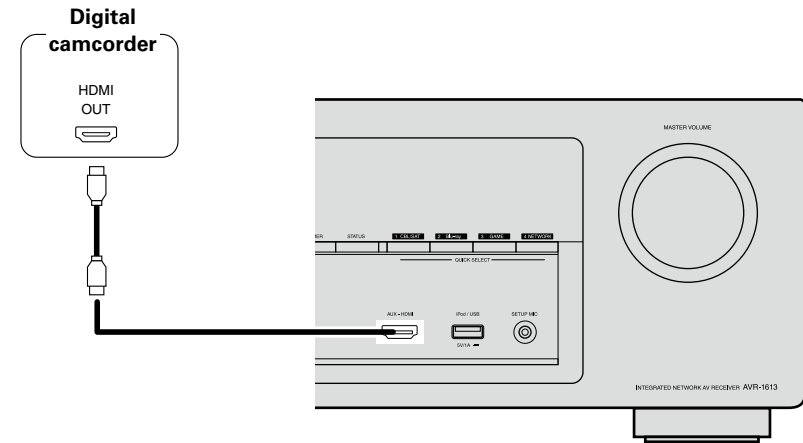

[Front panel]



- When this unit is connected to other devices with HDMI cables, connect this unit and TV also with an HDMI cable.
- When connecting a device that supports Deep Color, please use a “High Speed HDMI cable” or “High Speed HDMI cable with Ethernet”.
- Video signals are not output if the input video signals do not match the monitor’s resolution. In this case, switch the Blu-ray Disc/DVD player’s resolution to a resolution with which the monitor is compatible.

HDMI function

This unit supports the following HDMI functions:

□ About 3D function

This unit supports input and output of 3D (3 dimensional) video signals of HDMI.

To play back 3D video, you need a TV and player that provide support for the HDMI 3D function and a pair of 3D glasses.

NOTE

- When playing back 3D video, refer to the instructions provided in the manual of your playback device together with this manual.
- When playing back 3D video content, the menu screen or status display screen can be superimposed over the image. However, the menu screen or status display screen cannot be superimposed over certain 3D video content.
- If 3D video with no 3D information is input, the menu screen and status display on this unit are displayed over the playback video.
- If 2D video is converted to 3D video on the television, the menu screen and status display on this unit are not displayed correctly. To view the menu screen and status display on this unit correctly, turn the television setting that converts 2D video to 3D video off.

□ HDMI control function (page 73)

This function allows you to operate external devices from the unit and operate the unit from external devices.

NOTE

- The HDMI control function may not work depending on the device it is connected to and its settings.
- You cannot operate a TV or Blu-ray Disc player/DVD player that is not compatible with the HDMI control function.

□ About Content Type

This function was added with the HDMI standard. It automatically makes settings suitable for the video-output type (content information).

□ Deep Color (page 117)

When a device supporting Deep Color is connected, use a cable compatible with "High Speed HDMI cable" or "High Speed HDMI cable with Ethernet".

□ Auto Lip Sync (page 87, 117)

□ "x.v.Color", sYCC601 color, Adobe RGB color, Adobe YCC601 color (page 117, 118)

□ High definition digital audio format

□ ARC (Audio Return Channel) (page 8)

Copyright protection system

In order to play back digital video and audio such as BD-Video or DVD-Video via HDMI connection, both this unit and TV or the player need to support the copyright protection system known as HDCP (High-bandwidth Digital Content Protection System). HDCP is copyright protection technology comprised of data encryption and authentication of the connected AV devices. This unit supports HDCP.

- If a device that does not support HDCP is connected, video and audio are not output correctly. Read the owner's manual of your television or player for more information.

Settings related to HDMI connections

Set as necessary. For details, see the respective reference pages.

□ HDMI Setup (page 87)

Make settings for HDMI video/audio output.

- Auto Lip Sync
- HDMI Audio Out
- HDMI Control
- Standby Source
- P.Off Control

NOTE

The audio signal input from the HDMI input connector can be output as an output signal from the HDMI output connector by setting the HDMI audio output destination to TV.

















Audio signals input via the Analog/Coaxial/Optical input connectors cannot be output from the HDMI MONITOR output connector.

Connecting an HDMI-incompatible device





For high quality video and surround playback, it is recommended to use an HDMI cable to connect this unit to TV and other video devices (see [page 7](#) "Connecting an HDMI-compatible device").

This section describes connections when your device does not support HDMI connections.

Connection methods for various devices

 TV	 page 13	 CBL/SAT	 page 14
 DVD	 page 15	 iPod/USB	 page 16
 TUNER	 page 17	 NETWORK	 page 18
 SPEAKER	 page 70	 AC IN	 page 19

Cables used for connections

Video cable (sold separately)	
Video cable	
Audio cable (sold separately)	
Coaxial digital cable	
Optical cable	
Audio cable	
Cable (sold separately)	
Ethernet cable	

Changing the source assigned to connectors

This unit can change the source that is assigned to the DIGITAL AUDIO IN connectors.

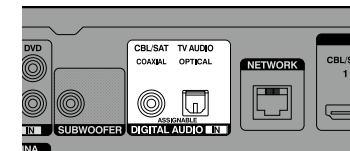

Here, a connection to the DVD player is taken as an example for explanation. The rear panel video input and digital audio input connectors do not have the input connector indication for DVD players (DVD). However, DIGITAL AUDIO IN connectors have the "ASSIGNABLE" indication, which means that you can change the source assigned to these connectors. You can assign DVD players to these connectors to use them for DVD players. Select "DVD" when switching functions on this unit to play back the source connected to these connectors.

How to change the source assigned to connectors ([page 90](#))

Connecting a TV

- This section describes how to connect when your TV does not support HDMI connections. For instructions on HDMI connections, see “Connecting an HDMI-compatible device” (page 7).
- If the TV connected to this unit is equipped with an HDMI connector that supports ARC, digital audio signals from TV can be transmitted to this unit (page 8 “About ARC (Audio Return Channel) function”). The ARC function allows you to enjoy on this unit the audio from TV programs and HDMI devices directly connected to TV, without having to make a separate audio connection. For the ARC function, also see your TV’s manual.
- To listen to TV audio through this device, use the optical digital connection.



For video connections, see “Relationship between video signals and monitor output” (page 116).

Audio connection

The following methods are available for connecting to this unit. **Use either of the methods to make a connection.**

The numbers prefixed with connectors indicate the recommendation order. The smaller the number is, the higher playback quality is achieved.

1 DIGITAL AUDIO OPTICAL connector DIGITAL AUDIO COAXIAL connector *

When a multichannel audio (digital bit stream audio) is input, this unit decodes the audio to play back surround sound.

* When making this type of connection, you must change the settings on this unit.

(Input connector setting)

Video connection

The following methods are available for connecting to this unit.

The numbers prefixed with connectors indicate the recommendation order. The smaller the number is, the higher playback quality is achieved.

1 VIDEO OUT (MONITOR) connector

This makes an analog video connection.

Input connector setting

When making the following connection, you must change the input connector settings.

1 DIGITAL AUDIO COAXIAL connector

Change the default “CBL/SAT” to “TV AUDIO”.

For how to change, see “Digital Assign” (page 90).

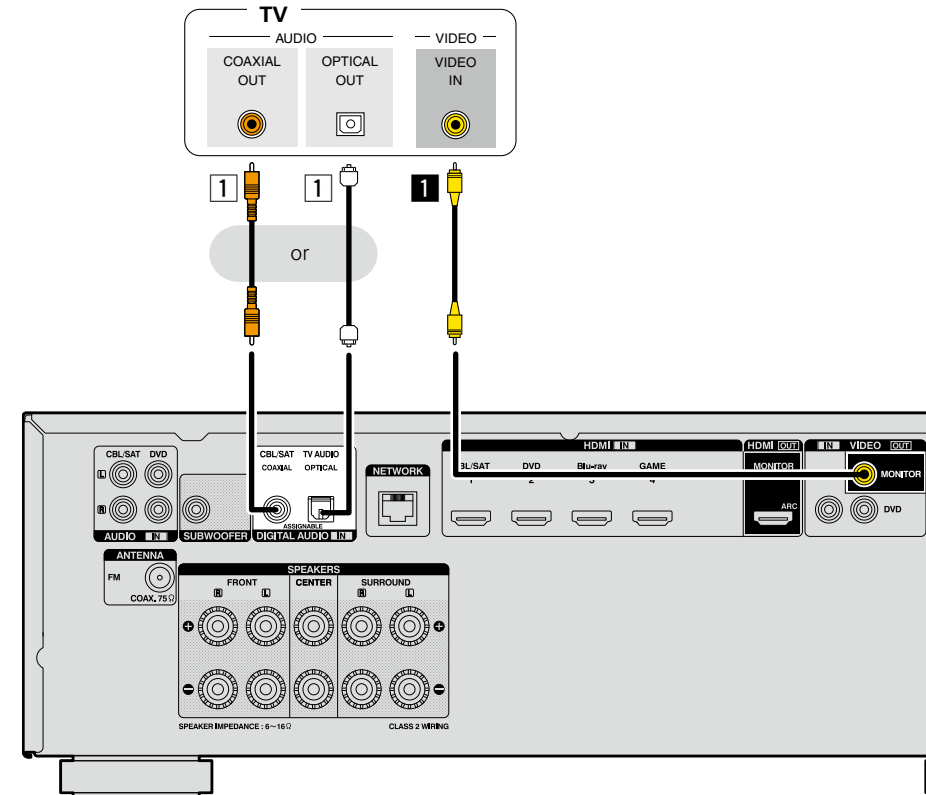

NOTE

The menu screen is only displayed on TV connected to this unit via HDMI. If your TV is connected to this unit via other video output connectors, perform menu operations while seeing the display on this unit.

Connecting a set-top box (Satellite tuner/cable TV)

This section describes how to connect when your satellite tuner or cable TV does not support HDMI connections.

For instructions on HDMI connections, see “Connecting an HDMI-compatible device” ([page 7](#)).

Audio connection

The following methods are available for connecting to this unit. **Use either of the methods to make a connection.**

The numbers prefixed with connectors indicate the recommendation order. The smaller the number is, the higher playback quality is achieved.

1 DIGITAL AUDIO COAXIAL connector DIGITAL AUDIO OPTICAL connector *

When a multichannel audio (digital bit stream audio) is input, this unit decodes the audio to play back surround sound.

* When making this type of connection, you must change the settings on this unit.

([Input connector setting](#))

2 AUDIO IN (CBL/SAT) connector

This makes an analog audio connection. This type of connection converts digital audio to analog audio, so the output audio may be degraded compared to connections 1.

Video connection

The following methods are available for connecting to this unit.

The numbers prefixed with connectors indicate the recommendation order. The smaller the number is, the higher playback quality is achieved.

1 VIDEO IN (CBL/SAT) connector

This makes an analog video connection.

Input connector setting

When making the following connection, you must change the input connector settings.

1 DIGITAL AUDIO OPTICAL connector

Change the default “TV AUDIO” to “CBL/SAT”.

For how to change, see “Digital Assign” ([page 90](#)).

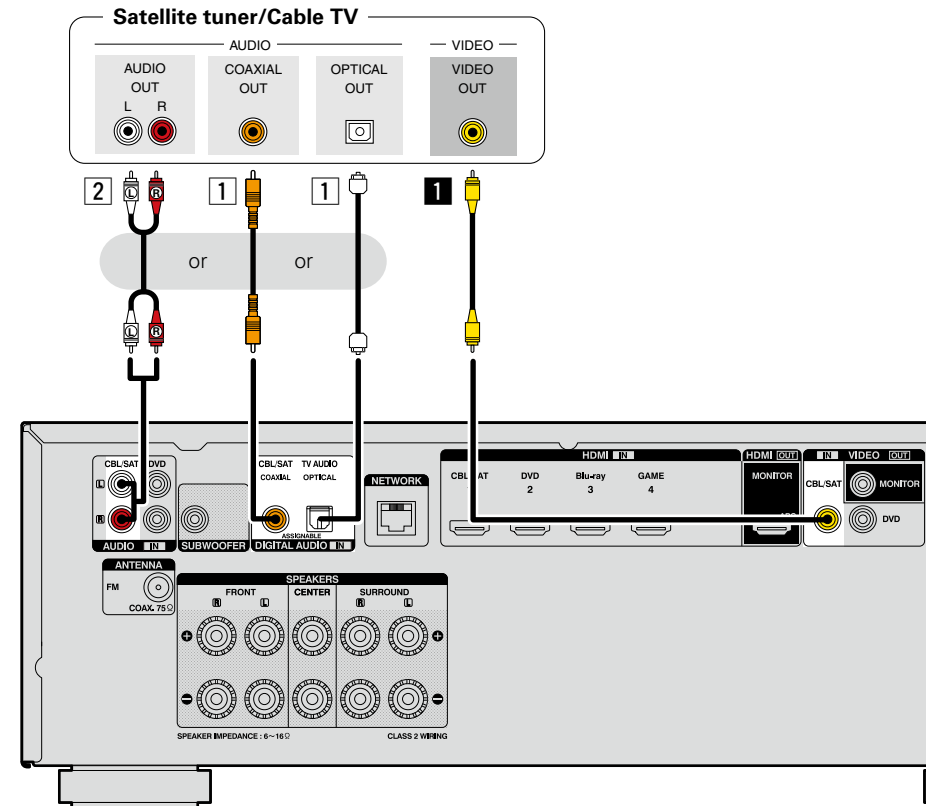

Connecting a DVD player

This section describes how to connect when your DVD player does not support HDMI connections. For instructions on HDMI connections, see “Connecting an HDMI-compatible device” (page 7).

Audio connection

The following methods are available for connecting to this unit. **Use either of the methods to make a connection.**

The numbers prefixed with connectors indicate the recommendation order. The smaller the number is, the higher playback quality is achieved.

1 DIGITAL AUDIO COAXIAL connector DIGITAL AUDIO OPTICAL connector

When a multichannel audio (digital bit stream audio) is input, this unit decodes the audio to play back surround sound.

When making this type of connection, you must change the settings on this unit.

(Input connector setting)

2 AUDIO IN (DVD) connector

This makes an analog audio connection. This type of connection converts digital audio to analog audio, so the output audio may be degraded compared to connections 1.

Video connection

The following methods are available for connecting to this unit.

The numbers prefixed with connectors indicate the recommendation order. The smaller the number is, the higher playback quality is achieved.

1 VIDEO IN (DVD) connector

This makes an analog video connection.

Input connector setting

When making the following connection, you must change the input connector settings.

1 DIGITAL AUDIO COAXIAL connector

Change the default “CBL/SAT” to “DVD”.

DIGITAL AUDIO OPTICAL connector

Change the default “TV AUDIO” to “DVD”.

For how to change, see “Digital Assign” (page 90).

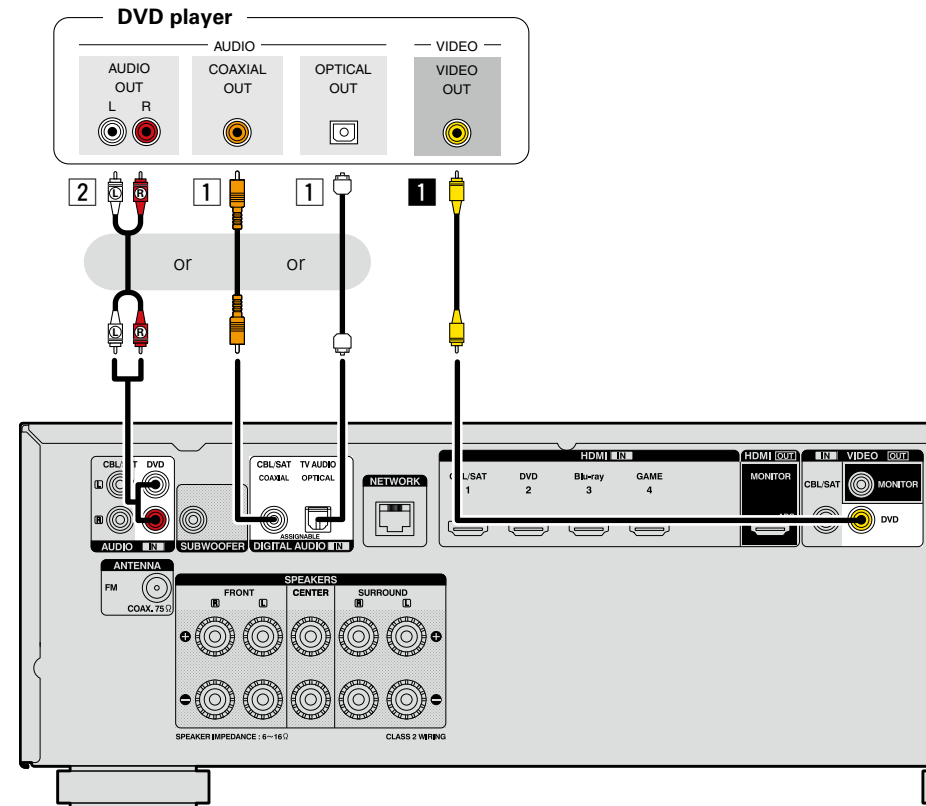

Connecting an iPod or USB memory device to the iPod/USB port

- You can enjoy music stored on an iPod or USB memory device.
- For operating instructions see “Playing an iPod” (page 29) or “Playing a USB memory device” (page 32).

Cables used for connections

To connect an iPod to this unit, use the USB cable supplied with the iPod.

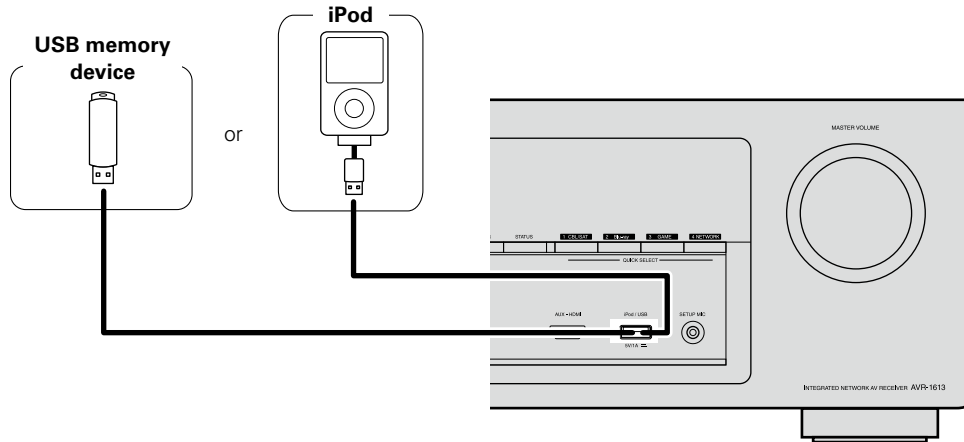

DENON does not guarantee that all USB memory devices will operate or receive power. When using a portable USB connection type HDD of the kind to which an AC adapter can be connected to supply power, use the AC adapter.

NOTE

- USB memory devices will not work via a USB hub.
- It is not possible to use this unit by connecting the unit's iPod/USB port to a PC via a USB cable.
- Do not use an extension cable when connecting a USB memory device. This may cause radio interference with other devices.
- This unit does not support playback on an iPad. Do not connect an iPad to the unit.
- When connecting an iPhone to this unit, keep the iPhone at least 20 cm away from this unit. If the iPhone is kept closer to this unit and a telephone call is received by the iPhone, noise may be output from this device.
- If the iPod is connected using an iPod cable (commercially available) that is longer than 2 m (6.6 ft), sound may not be played correctly. In this case, use a genuine iPod cable, or a cable that is shorter than 1 m (3.3 ft).

Supported iPod models

• iPod / iPod classic



iPod classic
80GB



iPod classic
160GB (2007)



iPod classic
160GB (2009)

• iPod nano



iPod nano
3rd generation
(video)
4GB 8GB



iPod nano
4th generation (video)
8GB 16GB



iPod nano
5th generation (video camera)
8GB 16GB



iPod nano
6th generation
8GB 16GB

• iPod touch



iPod touch
1st generation
8GB 16GB 32GB



iPod touch
2nd generation
8GB 16GB 32GB



iPod touch
3rd generation
32GB 64GB



iPod touch
4th generation
8GB 32GB 64GB

• iPhone



iPhone
4GB 8GB 16GB



iPhone 3G
8GB 16GB



iPhone 3GS
8GB 16GB 32GB



iPhone 4
16GB 32GB



iPhone 4S
16GB 32GB 64GB

(as of March 2012)

Connecting an FM antenna

- Connect the FM antenna supplied with the unit to enjoy listening to radio broadcasts.
- After connecting the antenna and receiving a broadcast signal ([page 35](#) “Listening to FM broadcasts”), fix the antenna with tape in a position where the noise level becomes minimal.

NOTE

- Do not connect two FM antennas simultaneously.
- If you are unable to receive a good broadcast signal, we recommend installing an outdoor antenna. For details, inquire at the retail store where you purchased the unit.

Direction of broadcasting station

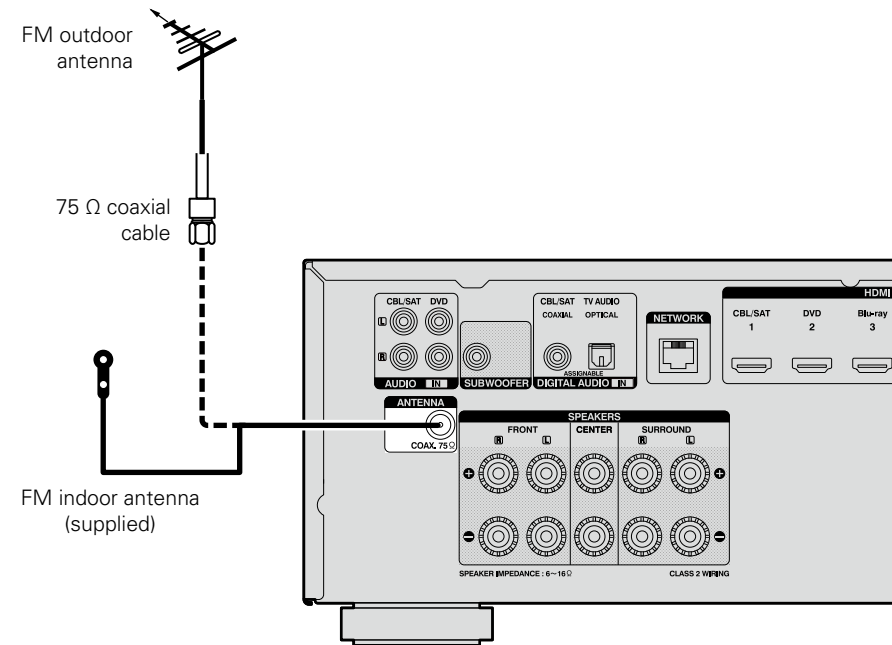

Connecting to a home network (LAN)

You can connect this unit to your home network (LAN) to perform various types of playbacks and operations as follows. Make network connections for this unit by carefully reading information on this page.

- Playback of network audio such as the Internet radio and music servers
- Playback of music from online services
- AirPlay
- Operations on this unit via the network

In addition, when an updated firmware becomes available for improving this unit, the update information is delivered from us to this unit over the network. You can then download the latest firmware. For more information, on the menu, select "Update" (page 104).

Network settings are necessary. See "Network" on the menu (page 97) for more information on network setting.

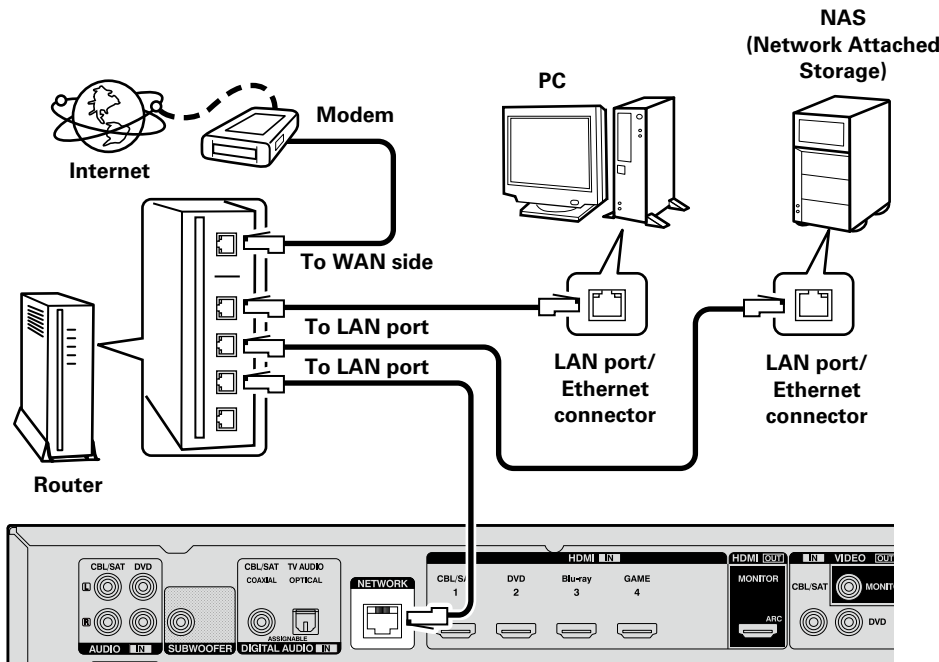

For connections to the Internet, contact an ISP (Internet Service Provider) or a computer shop.

Required system

❑ Broadband internet connection

❑ Modem

Device that connects to the broadband circuit and conducts communications on the Internet. A type that is integrated with a router is also available.

❑ Router

When using this unit, we recommend you use a router equipped with the following functions:

- Built-in DHCP server
This function automatically assigns IP addresses on the LAN.
- Built-in 100BASE-TX switch
When connecting multiple devices, we recommend a switching hub with a speed of 100 Mbps or greater.

❑ Ethernet cable (CAT-5 or greater recommended)

- Use only a shielded STP or ScTP LAN cable which is available at retailer.
- The normal shielded-type Ethernet cable is recommended. If a flat-type cable or unshielded-type cable is used, other devices could be affected by noise.



- If you have an Internet provider contract for a line on which network settings are made manually, make the settings at "Network" (page 97).
- With this unit, it is possible to use the DHCP and Auto IP functions to make the network settings automatically.
- When using this unit with the broadband router's DHCP function enabled, this unit automatically performs the IP address setting and other settings.
When using this unit connected to a network with no DHCP function, make the settings for the IP address, etc., at "Network" (page 97).
- When setting manually, check the setting contents with the network administrator.

NOTE

- A contract with an ISP is required to connect to the Internet.
No additional contract is needed if you already have a broadband connection to the Internet.
- The types of routers that can be used depend on the ISP. Contact an ISP or a computer shop for details.
- DENON assumes no responsibility whatsoever for any communication errors or troubles resulting from customer's network environment or connected devices.
- This unit is not compatible with PPPoE. A PPPoE-compatible router is required if you have a contract for a type of line set by PPPoE.
- Do not connect an NETWORK connector directly to the LAN port/ Ethernet connector on your computer.
- To listen to audio streaming, use a router that supports audio streaming.

Connecting the power cord

After completing all the connections, insert the power plug into the power outlet.

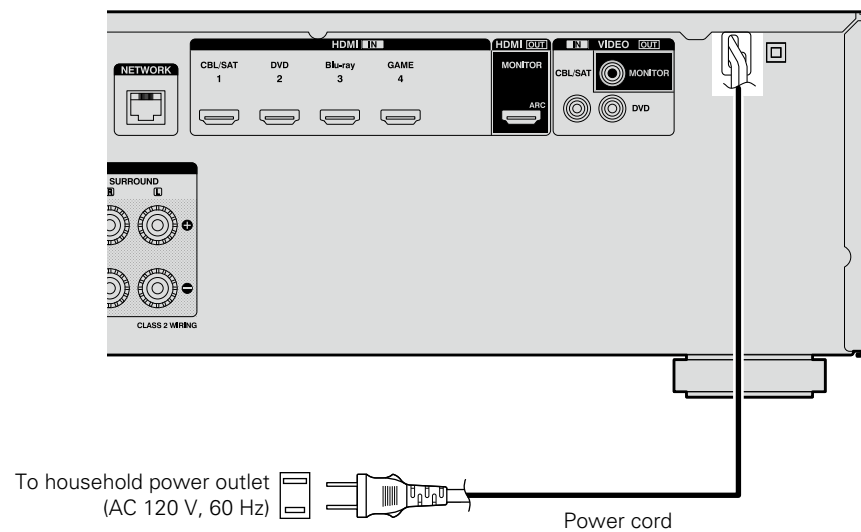

NOTE

- **Do not plug in the power cord until all connections have been completed.**
- Do not bundle power cords together with connection cables. Doing so can result in humming or noise.

Settings

Here, we explain “Audyssey® Setup”, which allows you to automatically make the optimal settings for your speakers, and “Network”, which allows you to connect this unit to a home network (LAN).

This unit lets you play via your home network (LAN) music files stored on a computer and music content such as that from Internet radio.

❑ **Speaker connection** (👉 page 70)

❑ **Set up speakers (Audyssey® Setup)** (👉 page 20)

❑ **Making the network settings (Network)**
(👉 page 26)

Playback (Basic operation) (👉 page 27)

Selecting a listening mode (Sound Mode)
(👉 page 64)

Playback (Advanced operation) (👉 page 73)



Set up speakers (Audyssey® Setup)



The acoustic characteristics of the connected speakers and listening room are measured and the optimum settings are made automatically. This is called “Audyssey® Setup”.

To perform measurement, place the setup microphone in multiple locations all around the listening area. For best results, we recommend you measure in six positions, as shown in the illustration (up to six positions).

- When performing Audyssey® Setup, Audyssey MultEQ®/Audyssey Dynamic EQ®/Audyssey Dynamic Volume® functions become active (👉 page 84).
- To set up the speakers manually, use “Speakers” (👉 page 93) on the menu.

NOTE

- Make the room as quiet as possible. Background noise can disrupt the room measurements. Close windows and turn off the power on electronic devices (TVs, radios, air conditioners, fluorescent lights, etc.). The measurements could be affected by the sounds emitted by such devices.
- During the measurement process, place cell phones outside the listening room. Cell phone signals could disrupt the measurements.
- Do not unplug the setup microphone from the main unit until Audyssey® Setup is completed.
- Do not stand between the speakers and setup microphone or allow obstacles in the path while the measurements are being made. This will cause inaccurate readings.
- During the measurement process, loud test sounds may be played, but this is part of normal operation. If there is background noise in room, these test signals will increase in volume.
- Operating **VOLUME ▲▼** on the remote control unit or **MASTER VOLUME** on the main unit during the measurements will cancel the measurements.
- Measurement cannot be performed when headphones are connected. Unplug the headphones before performing Audyssey® Setup.

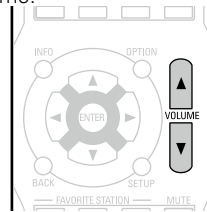

About setup microphone placement

- Measurements are performed by placing the setup microphone successively at multiple positions throughout the entire listening area, as shown in **[Example ①]**. For best results, we recommend you measure in six positions, as shown in the illustration (up to six positions).
- Even if the listening environment is small as shown in **[Example ②]**, measuring at multiple points throughout the listening environment results in more effective correction.

[Example ①]

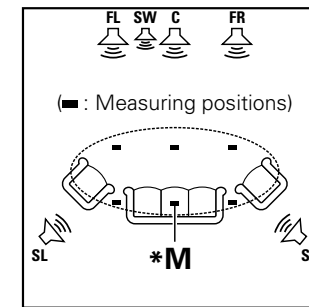

[Example ②]

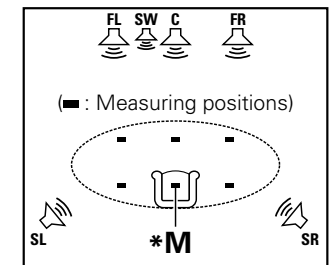

FL Front speaker (L)
FR Front speaker (R)
C Center speaker

SW Subwoofer
SL Surround speaker (L)
SR Surround speaker (R)

About the main listening position (*M)

The main listening position is the position where listeners would normally sit or where one would normally sit alone within the listening environment. Before starting Audyssey® Setup, place the setup microphone in the main listening position. Audyssey MultEQ® uses the measurements from this position to calculate speaker distance, level, polarity, and the optimum crossover value for the subwoofer.

👉 See overleaf

1 Prepare the included setup microphone

Mount the setup microphone on a tripod or stand and place it in the main listening position.

When placing the setup microphone, adjust the height of the sound receptor to the level of the listener's ear.

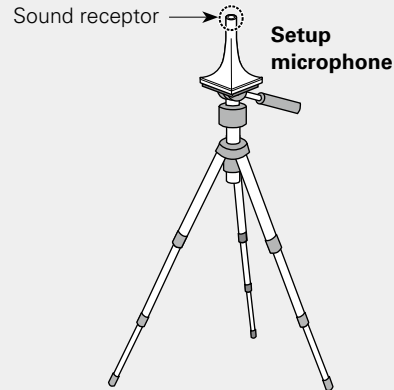

If you do not have a tripod or stand, set up the microphone on, for example, a seat without a back.

NOTE

- Do not hold the setup microphone in your hand during measurements.
- Avoid placing the setup microphone close to a seat back or wall as sound reflections may give inaccurate results.

2 Set up the subwoofer

If using a subwoofer capable of the following adjustments, set up the subwoofer as shown below.

For details, see your subwoofer's manual.

□ When using a subwoofer with a direct mode

Set the direct mode to "On" and disable the volume adjustment and crossover frequency setting.

□ When using a subwoofer without a direct mode

Make the following settings:

- **Volume** : "12 o'clock position"
- **Crossover frequency** : "Maximum/Highest Frequency"
- **Low pass filter** : "Off"
- **Standby mode** : "Off"

Preparation

3 Connect the setup microphone to the SETUP MIC jack of this unit.

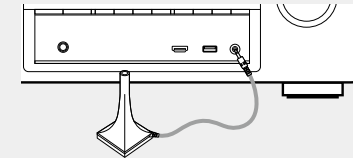

When the setup microphone is connected, the following screen is displayed.

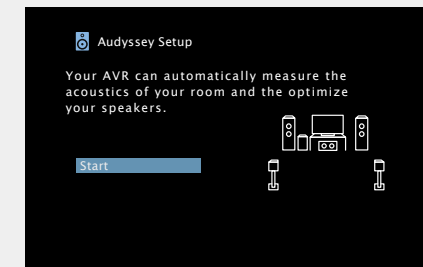

- For information about setting up and connecting the speakers, see "Installation/connection of speakers (Advanced)" ([page 69](#)).
- For connection to a TV, see "Connecting this unit to a TV via HDMI connections" ([page 9](#)).

See overleaf

Preparation (Continued)

4 Select “Start” and then press **ENTER**.

The subwoofer volume setting screen is displayed.

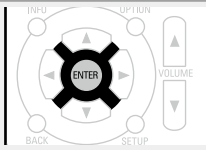
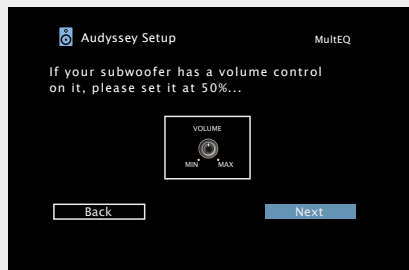
**5** Select “Next” and then press **ENTER**.

Detection & Measurement (Main)

- This step automatically checks the speaker configuration and speaker size, and calculates the channel level, distance, and crossover frequency. It also corrects distortion in the listening area.

6 Select “Begin Test” and then press **ENTER**.

When measuring begins, a test tone is output from each speaker.

- Measurement requires several minutes.

7 The detected speakers are displayed.

- The illustration below shows an example of when the front speakers, center speaker, subwoofer and surround speakers have been detected.

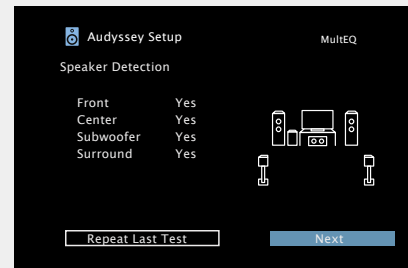
**NOTE**

If a connected speaker is not displayed, the speaker may not be connected correctly. Check the speaker connection.

8 Select “Next” and then press **ENTER**.**NOTE**

If “Caution!” is displayed on TV screen:

Go to “Error messages” ([page 25](#)). Check any related items, and perform the necessary procedures.

If the problem is resolved, return and restart “Audyssey® Setup”.

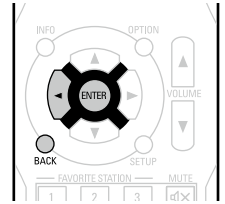
**Going back to the previous screen**

Press **BACK**.

When measuring has stopped

- Press **BACK** to display the popup screen.
- Press **LEFT** to select “Yes”, and then press **ENTER**.

Setting up the speakers again

Repeat the operation from step 3.

See overleaf

Measurement (2nd – 6th)

- In this step, you will perform measurements at multiple positions (two to six positions) other than the main listening position.
- Just one position can be measured but measuring multiple positions increases the accuracy of the correction of acoustic distortion within the listening area.

9 Move the setup microphone to position 2, select “Continue”, and then press ENTER.

The measurement of the second position starts. Measurements can be made in up to six positions.

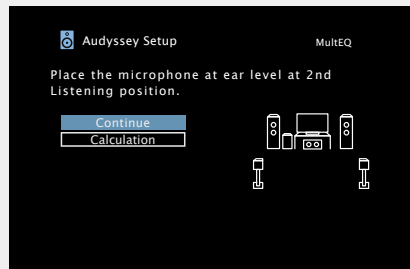
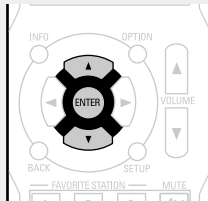

- To skip measuring the third and subsequent listening position, use $\Delta \nabla$ to select “Calculation” and press **ENTER** to proceed to step 12.
- To measure the second position again, use $\Delta \nabla$ to select “Repeat Last Test” and press **ENTER**.

Calculation

10 Repeat step 9, measuring positions 3 to 6.

When measurement of position 6 is completed, a “Measurements Complete.” message is displayed.

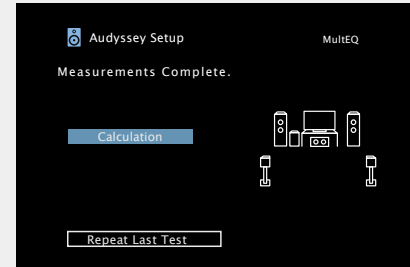

11 Select “Calculation” and then press ENTER.

Measuring results are analyzed, and the frequency response of each speaker in the listening room is determined.

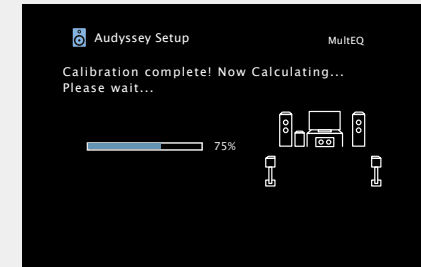

- Analysis takes several minutes to complete. The more speakers and measurement positions that there are, the more time it takes to perform the analysis.

See overleaf

Check

12 Use Δ / ∇ to select the item you want to check, and then press **ENTER**.

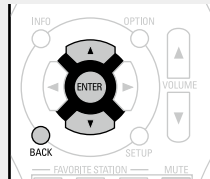

- Subwoofers may measure a greater reported distance than the actual distance due to added electrical delay common in subwoofers.
- If you want to check another item, press **BACK**.

NOTE

- If the result differs from the actual connection status, or if “Caution!” is displayed, see “Error messages” ([page 25](#)). Then carry out Audyssey® Setup again.
- If you change speaker positions or orientation, perform Audyssey® Setup again to find the optimal equalizer settings.

Store

13 Select “Store” and then press **ENTER**.
Save the measurement results.

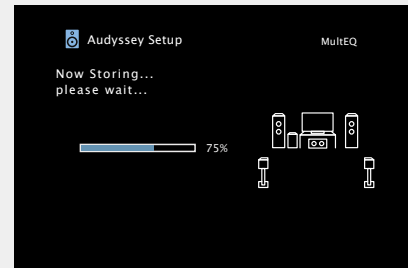
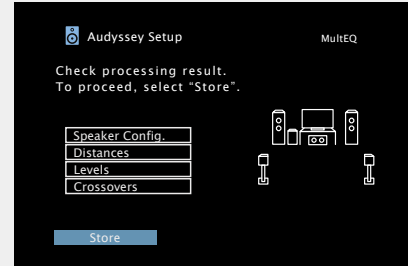

- Saving the results requires about 10 seconds.
- During saving of measurements results, “Now Storing...Please wait...” is displayed. When saving is completed, “Storing complete. Audyssey® Setup is now finished.” is displayed.

NOTE

During saving of measurement results, be sure not to turn off the power.

Finish

14 Unplug the setup microphone from the unit’s **SETUP MIC** jack.

15 Select “Next” and then press **ENTER**.

16 Set Audyssey Dynamic Volume®.

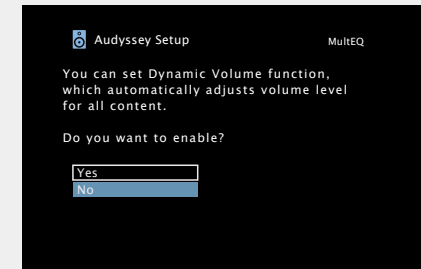

- This feature adjusts the output volume to the optimal level while constantly monitoring the level of the audio input to the unit. Optimal volume control is performed automatically without any loss in the dynamism and clarity of the sound when, for example, the volume suddenly increases for commercials shown during television programs.

When turning Dynamic Volume® on

- Press Δ to select “Yes”, and then press **ENTER**.
The unit automatically enters “Medium” ([page 84](#)) mode.

When turning Dynamic Volume® off

- Press ∇ to select “No”, and then press **ENTER**.

NOTE

After performing Audyssey® Setup, do not change the speaker connections or subwoofer volume. In event of a change, perform Audyssey® Setup again.

Error messages

NOTE

- An error message is displayed if Audyssey® Setup could not be completed due to speaker placement, the measurement environment, etc. If an error message is displayed, check the relevant items and perform the necessary measures. Then perform Audyssey® Setup again.
- If the result still differs from the actual connection status after remeasurement or the error message still appears, it is possible that the speakers are not connected properly. Turn this unit off, check the speaker connections and repeat the measurement process from the beginning.
- Be sure to turn off the power before checking speaker connections.

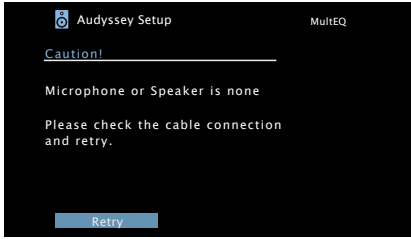
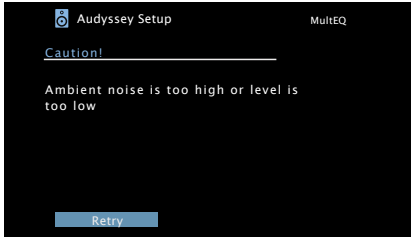
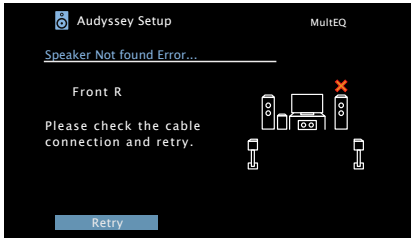
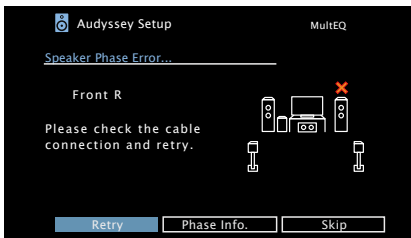
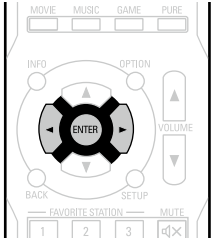
Examples	Error details	Measures
	<ul style="list-style-type: none"> • The connected setup microphone is broken, or a device other than the supplied setup microphone is connected. • Not all speakers could be detected. • A front speaker (left) was not properly detected. 	<ul style="list-style-type: none"> • Connect the included setup microphone to the SETUP MIC jack of this unit. • Check the speaker connections.
	<ul style="list-style-type: none"> • There is too much noise in the room for accurate measurements to be made. • Speaker or subwoofer sound is too low for accurate measurements to be made. 	<ul style="list-style-type: none"> • Either turn off any device generating noise or move it away. • Perform again when the surroundings are quieter. • Check the speaker installation and the direction in which the speakers are facing. • Adjust the subwoofer's volume.
	<ul style="list-style-type: none"> • The displayed speaker could not be detected. (The screen on the left indicates that the front right speaker cannot be detected.) 	<ul style="list-style-type: none"> • Check the connections of the displayed speaker.
	<ul style="list-style-type: none"> • The displayed speaker is connected with the polarity reversed. (The screen on the left indicates that the polarity phases of the front right speakers are reversed.) 	<ul style="list-style-type: none"> • Check the polarity of the displayed speaker. • For some speakers, this error message may be displayed even if the speaker is properly connected. If you are sure the connection is correct, use ◀ ▶ to select "Skip", then press ENTER. 

Parameter Check

This function enables you to check the measurement results and equalizer characteristics after Audyssey® Setup.

1 Use Δ / ∇ to select “Parameter Check” and then press ENTER.

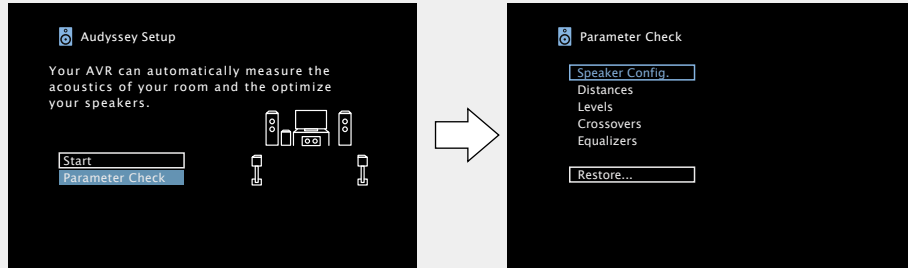

2 Use Δ / ∇ to select the item you want to check, then press ENTER or \triangleright .

Measurement results for each speaker are displayed.

Speaker Config.	Check the speaker configuration.
Distances	Check the speaker distance.
Levels	Check the speaker channel level.
Crossovers	Check the speaker crossover frequency.
Equalizers	Check the equalizer.

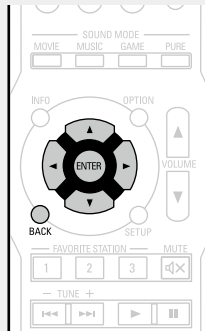

- If “Equalizers” is selected, press Δ / ∇ to select equalizing curve (“Audyssey” or “Audyssey Flat”) to be checked.
Use \triangleleft / \triangleright to switch the display between the different speakers.

3 Press BACK.

The confirmation screen reappears. Repeat step 2.

Retrieving Audyssey® Setup settings

If you set “Restore...” to “Yes”, you can return to Audyssey® Setup measurement result (value calculated at the start by MultEQ®) even when you have changed each setting manually.



Making the network settings (Network)



This unit can be connected to a home network (LAN) to listen to Internet radio or play back music files and still image (JPEG) files stored on a computer.

1 Connect the Ethernet cable (☞ page 18 “Connecting to a home network (LAN)”).

2 Turn on this unit (☞ page 27).

This unit performs automatic network setup due to the DHCP function.
When connecting to a network that has no DHCP function, perform the setting in “Settings” (☞ page 99).

Playback (Basic operation)

Settings (🔗 page 20)

- ❑ Turning the power on (🔗 page 27)
- ❑ Selecting the input source (🔗 page 27)
- ❑ Adjusting the master volume (🔗 page 28)
- ❑ Turning off the sound temporarily (🔗 page 28)

❑ Playing a Blu-ray Disc player/DVD player (🔗 page 28)

- ❑ Playing an iPod (🔗 page 29)
- ❑ Playing a USB memory device (🔗 page 32)
- ❑ Listening to FM broadcasts (🔗 page 35)

❑ Listening to internet radio (🔗 page 43)

❑ Playing back files stored on a PC and NAS (🔗 page 46)

- ❑ Using online services (🔗 page 50)
- ❑ Convenient functions (🔗 page 58)
- ❑ AirPlay function (🔗 page 62)

Selecting a listening mode (Sound Mode) (🔗 page 64)

Playback (Advanced operation) (🔗 page 73)

Important information

Before starting playback, make the connections between the different devices and the settings on the unit.

NOTE

Also refer to the operating instructions of the connected devices when playing them.

Turning the power on

Press **POWER**  to turn on power to the unit.

The power indicator lights green and the power turns on.

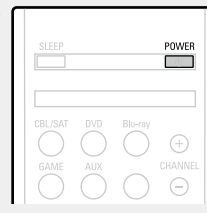

You can also switch the power to standby by pressing  on the main unit.

❑ When power is switched to standby

Press **POWER** .

[Power indicator status in standby mode]

- Normal standby : Off
- When "HDMI Control" (🔗 page 87) is set to "On" : Red
- When "IP Control" (🔗 page 98) is set to "Always On" : Red

Selecting the input source

Press the input source select button (**CBL/SAT, DVD, Blu-ray, GAME, AUX, iPod/USB, TV AUDIO, FM, NETWORK or INTERNET RADIO**) to be played back.

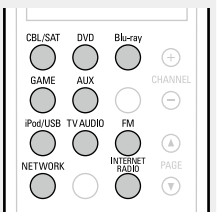

The desired input source can be selected directly.



You can also use the following operation to select an input source.

❑ Using the button on the main unit

Use **SOURCE SELECT**  .

- Using **SOURCE SELECT**   switches the input source, as shown below.

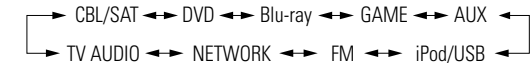

Adjusting the master volume

Use **VOLUME ▲▼** to adjust the volume.

- The volume display method varies depending on the "Scale" setting ([page 83](#)).

□ When the "Scale" setting ([page 83](#)) is "0 – 98"

[Adjustable range] 0.0 0.5 – 98.0

□ When the "Scale" setting ([page 83](#)) is "–79.5dB – 18.0dB"

[Adjustable range] ----- –79.5dB – 18.0dB

- The variable range differs according to the input signal and channel level setting.

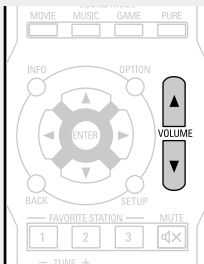



You can also adjust the master volume by turning **MASTER VOLUME** on the main unit.

Turning off the sound temporarily

Press **MUTE** .

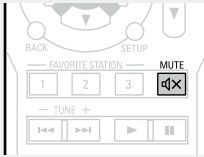
- "MUTE" indicator on the display flashes.
-  appears on a TV screen.



- The sound is reduced to the level set at "Mute Level" ([page 83](#)).
- To cancel, press **MUTE**  again. Muting can also be canceled by adjusting the master volume.

Playing a Blu-ray Disc player/DVD player

The following describes the procedure for playing Blu-ray Disc player/DVD player.

1 Prepare for playback.

- Turn on the power of the TV, subwoofer and player.
- Change the TV input to the input of this unit.
- Load the disc in the player.



2 Press **POWER** to turn on power to the unit.

3 Press **Blu-ray** or **DVD** to switch an input source for a player used for playback.

4 Play the Blu-ray Disc player or DVD player.

- Make the necessary settings on the player (language setting, subtitles setting, etc.) beforehand.

Playing an iPod

You can use the USB cable provided with the iPod to connect the iPod with the unit's iPod/USB port and enjoy music stored on the iPod.

For information on the iPod models that can be played back with this unit, see "Connecting an iPod or USB memory device to the iPod/USB port" ([page 16](#)).

NOTE

This unit supports audio playback from the iPod (fifth generation or later), iPod nano, iPod classic, iPod touch and iPhone (it is not compatible with iPod shuffle).

Note that Remote Mode is not supported for the 5th generation iPod or the 1st generation iPod nano.

Listening to music on an iPod

The iPod display modes include "Remote Mode" and "Browse Mode".

By default, "Remote Mode", where you directly operate iPod itself while seeing the iPod screen, is set.

To change to "Browse Mode", where you perform operations while having the iPod information displayed on the TV screen, see "Setting "Browse Mode" (Operation Mode)" ([page 30](#)).

1 Using the USB cable provided with the iPod, connect the iPod to the iPod/USB port ([page 16](#)).

2 Press **POWER**  to turn on power to the unit.

3 Press **iPod/USB** to switch the input source to "iPod/USB".
"Remote iPod" is displayed on the display of this unit.

- Nothing is displayed on the TV screen.

4 Operate iPod itself directly while seeing the iPod screen to play back music.

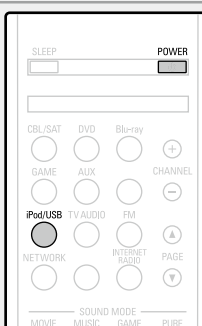

Streaming music stored in iPhone, iPod touch or iPad directly to the unit ([page 62](#))

Playing iTunes music with this unit
([page 62](#))

Operations available through the OPTION button

Press the **OPTION** button to display a menu of functions that can be used on the TV screen. Select the function you want to use from this menu. You can easily find and use the desired function.

Setting "Browse Mode" (Operation Mode)
([page 30](#))

Performing repeat playback (Repeat)
([page 31](#))

Performing random playback (Random)
([page 31](#))

❑ Setting “Browse Mode” (Operation Mode)

In this mode, various lists and screens during playback on iPod are displayed on the TV screen.

This section describes the steps up to playing back tracks on iPod in “Browse Mode”.

1 Press iPod/USB to switch the input source to “iPod/USB”.

2 Press **OPTION**.
The option menu screen is displayed.

3 Select “Operation Mode”, then press **ENTER**.
The “Operation Mode” screen is displayed.

- When you want to switch from “Remote Mode” to “Browse Mode”, press ∇ to select “Operation Mode”, and press **ENTER**.

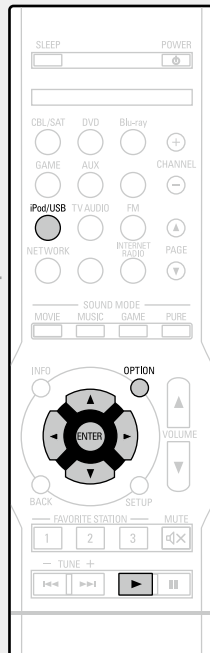
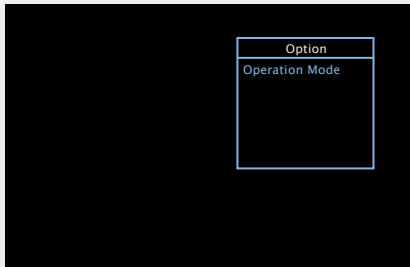

4 Use \triangleleft \triangleright to select “Browse Mode”, then press **ENTER**.
The iPod screen is displayed.

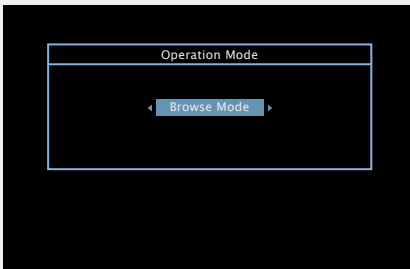

- English letters, numbers and certain symbols are displayed. Incompatible characters are displayed as “.” (period).
- Operations available for “Browse Mode” and “Remote Mode” are listed below.

Display mode		Remote Mode	Browse Mode
Playable files	Music file	✓	✓
	Video file	*	
Active buttons	Remote control unit (This unit)	✓	✓
	iPod	✓	

* Only the sound is played.

5 Use \triangle ∇ to select the item, then press **ENTER** or \triangleright to select the file to be played.

6 Press **ENTER**, \triangleright or \blacktriangleright .
Playback starts.

❑ Adjusting the sound quality (Restorer)

Make this setting at “Restorer” ([page 83](#)) in the menu.

You can use the “Restorer” function to restore to a state close to the audio before compression while correcting the bass feel to enjoy a richer playback experience. The default setting is “Mode3 (Low)”.

❑ Changing the screen display duration

Make this setting at “Audio Display” ([page 88](#)) in the menu. The default setting is “30s”.

Press \triangle ∇ \triangleleft \triangleright while the display is off to return to the original screen.

❑ Switching the screen display

In Browse Mode, press **STATUS** on the main unit during playback.

The display switches between track title, artist name, and album title each time the button is pressed.

NOTE

- Depending on the type of iPod and the software version, some functions may not operate.
- Note that DENON will accept no responsibility whatsoever for any problems arising with the data on an iPod when using this unit in conjunction with the iPod.

□ Performing repeat playback (Repeat)

1 Press **OPTION** while in Browse Mode.
The option menu screen is displayed.

2 Use Δ/∇ to select "Repeat", then press **ENTER**.

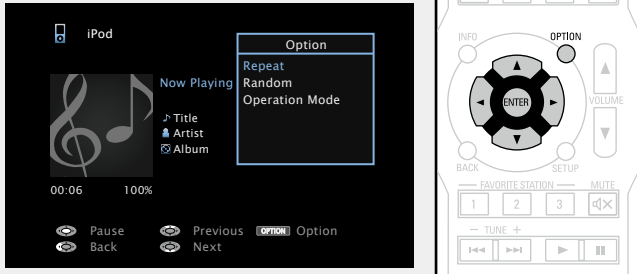

3 Use $\triangleleft/\triangleright$ to select repeat playback mode.

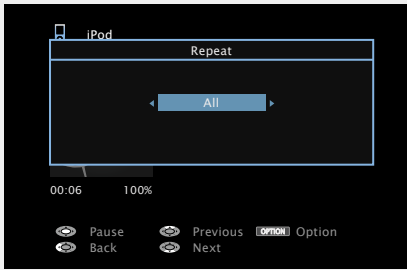

• Each time $\triangleleft/\triangleright$ is pressed, the setting is changed as shown below.



Off Repeat playback mode is canceled.

One A file being played is played repeatedly.

All All files in the folder currently being played are played repeatedly.

4 Press **ENTER**.
The display returns to the playback screen.

□ Performing random playback (Random)

1 Press **OPTION** while in Browse Mode.
The option menu screen is displayed.

2 Use Δ/∇ to select "Random", then press **ENTER**.

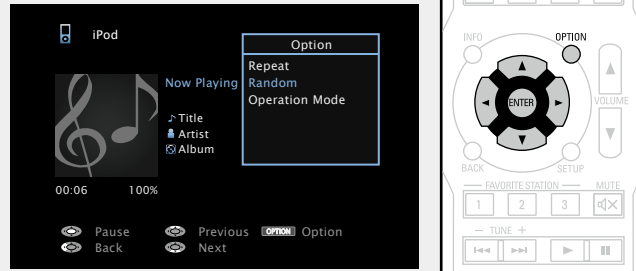

3 Use $\triangleleft/\triangleright$ to select random playback mode.

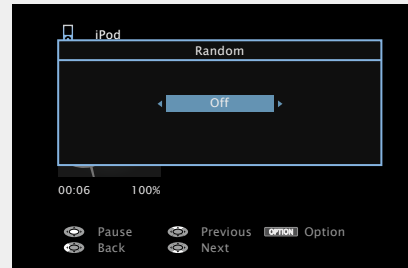

• Each time $\triangleleft/\triangleright$ is pressed, the setting is changed as shown below.

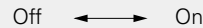

Off Disable random playback.

On Enable random playback.

4 Press **ENTER**.
The display returns to the playback screen.



The random playback randomly selects a track to play back from all tracks every time a track ends. Therefore, the same track may be played back consecutively.

□ iPod operation buttons

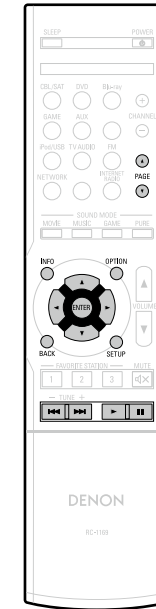

Operation buttons	Function
PAGE $\blacktriangle/\blacktriangledown$	Page search
INFO	Display of information such as the source name, volume, and sound mode name
OPTION	Browse / Remote Mode switching / Repeat playback / Random playback
$\triangleleft/\triangleright/\blacktriangle/\blacktriangledown$	Cursor operation / Auto search (cue, Δ/∇) / Manual search (Press and hold, Δ/∇)
ENTER (Press and release)	Enter
ENTER (Press and hold)	Stop
BACK	Return
SETUP	Setup menu
$\blacktriangleleft/\blacktriangleright/\blacktriangleleft/\blacktriangleright$	Auto search (cue)
\blacktriangleright	Playback
II	Pause



Playing a USB memory device

Playing back music or still picture (JPEG) files recorded on a USB memory device.

Important information

- Only USB memory devices conforming to mass storage class and MTP (Media Transfer Protocol) standards can be played on this unit.
- This unit is compatible with USB memory devices in "FAT16" or "FAT32" format.
- This unit is compatible with MP3 files conforming to "MPEG-1 Audio Layer-3" standards.
- File types that this unit can play back and specifications are shown below.

[Supported file types]

Supported file types	USB memory devices *1
WMA (Windows Media Audio)	✓*2
MP3 (MPEG-1 Audio Layer-3)	✓
WAV	✓
MPEG-4 AAC	✓*3
FLAC (Free Lossless Audio Codec)	✓
JPEG	✓

*1 USB memory device

- This unit is compatible with MP3 ID3-Tag (Ver. 2) standard.
- This unit can show the artwork that was embedded by using MP3 ID3-Tag Ver. 2.3 or 2.4.
- This unit is compatible with WMA META tags.
- If the image size (pixels) of an album artwork exceeds 500 × 500 (WMA/MP3/WAV/FLAC) or 349 × 349 (MPEG-4 AAC), then music may not be played back properly.

*2 Copyright-protected files can be played on certain portable players compatible with MTP.

*3 Only files that are not protected by copyright can be played on this unit.

Content downloaded from pay sites on the Internet are copyright protected. Also, files encoded in WMA format when ripped from a CD, etc. on a computer may be copyright protected, depending on the computer's settings.

NOTE

File types that this unit does not support are not displayed.

[Compatible formats]

	Sampling frequency	Bit rate	Extension
WMA (Windows Media Audio)	32/44.1/48 kHz	48 – 192 kbps	.wma
MP3 (MPEG-1 Audio Layer-3)	32/44.1/48 kHz	32 – 320 kbps	.mp3
WAV	32/44.1/48 kHz	–	.wav
MPEG-4 AAC	32/44.1/48 kHz	16 – 320 kbps	.aac/ .m4a/ .mp4
FLAC (Free Lossless Audio Codec)	32/44.1/48/88.2/96 kHz	–	.flac

Maximum Number of Playable Files and Folder

The limits on the number of folders and files that can be displayed by this unit are as follows.

Item	Media	USB memory devices
Memory capacity		FAT16 : 2 GB, FAT32 : 2 TB
Number of folder directory levels		8 levels
Number of folders		FAT16 or FAT32 format
Number of files *		5000

* The limited number includes the root folder.

Playing files stored on USB memory devices

1 Connect the USB memory device to the iPod/USB port (☞ [page 16](#)).

2 Press **iPod/USB** to switch the input source to “iPod/USB”.

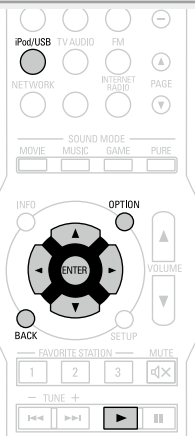
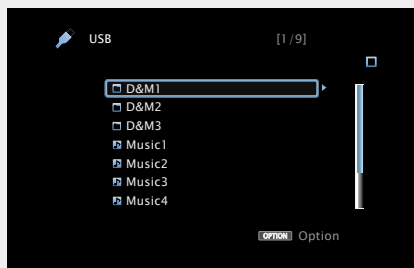

3 Use Δ / ∇ to select the search item or folder, then press **ENTER** or \triangleright .

4 Use Δ / ∇ to select the file, then press **ENTER**, \triangleright or \blacktriangleright . Playback starts.

❑ Adjusting the sound quality (Restorer)

Make this setting at “Restorer” (☞ [page 83](#)) in the menu.

You can use the “Restorer” function to restore to a state close to the audio before compression while correcting the bass feel to enjoy a richer playback experience. The default setting is “Mode3 (Low)”.

❑ Going back to the previous screen

Press \triangleleft or **BACK**.

❑ Changing the screen display duration

Make this setting at “Audio Display” (☞ [page 88](#)) in the menu. The default setting is “30s”.

Press Δ / ∇ / \triangleleft \triangleright while the display is off to return to the original screen.



- When an MP3 music file includes album art data, the album art can be displayed while playing the file.
- If the USB memory device is divided into multiple partitions, only the first partition is played back.

NOTE

- Note that DENON will accept no responsibility whatsoever for any problems arising with the data on a USB memory device when using this unit in conjunction with the USB memory device.
- USB memory devices will not work via a USB hub.
- DENON does not guarantee that all USB memory devices will operate or be supplied power. When using a USB portable hard disk that can draw power from an AC adapter, we recommend using the AC adapter.
- It is not possible to connect and use a computer via the iPod/USB port of this unit using a USB cable.

Operations available through the OPTION button

Press the **OPTION** button to display a menu of functions that can be used on the TV screen. Select the function you want to use from this menu. You can easily find and use the desired function.

❑ **Searching content with keywords (Text Search)** (☞ [page 58](#))

❑ **Performing repeat playback (Repeat)** (☞ [page 59](#))

❑ **Performing random playback (Random)** (☞ [page 59](#))

❑ **Playing back music and a favorite picture at the same time (Picture View)** (☞ [page 61](#))

❑ **Playing back still images in sequential order (Slideshow)** (☞ [page 61](#))

□ USB memory device operation buttons

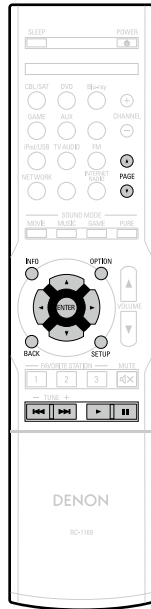

Operation buttons	Function
PAGE ▲▼	Page search
INFO	Display of information such as the source name, volume, and sound mode name
OPTION	Text Search / Repeat playback / Random playback / Picture View / Slideshow
△▽◀▶	Cursor operation / Auto search (cue, △▽)
ENTER (Press and release)	Enter
ENTER (Press and hold)	Stop
BACK	Return
SETUP	Setup menu
◀◀▶▶	Auto search (cue)
▶	Playback
⏸	Pause



Listening to FM broadcasts

For antenna connections, see “Connecting an FM antenna” ([page 17](#)).

How to tune in

The modes for receiving FM broadcasts consists of “Auto” mode that automatically searches available broadcast stations and “Manual” mode that lets you tune in using buttons to change the frequency. The default setting is “Auto”. You can also use “Direct Tune” to tune in by entering the frequency directly.

In “Auto” mode, you cannot tune in to radio stations if the reception is not good. If this is the case, then use the “Manual” mode or “Direct Tune” to tune in.

Listening to FM broadcasts

- 1 Press **FM** to switch the input source to “FM”.

[TV Screen]



[Display of this unit]

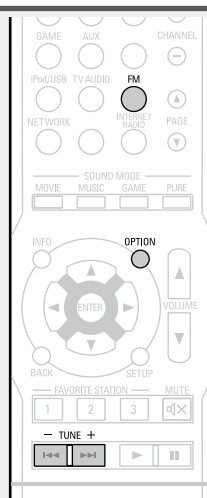
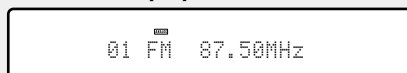

- 2 Press **TUNE +** or **TUNE -** to select the station you want to hear.

Scanning is performed until it finds an available radio station. When it finds a radio station, it stops the scan automatically and tunes in.

- Adding to the **FAVORITES STATION** button ([page 60](#))

Operations available through the OPTION button

Press the **OPTION** button to display a menu of functions that can be used on the TV screen. Select the function you want to use from this menu. You can easily find and use the desired function.

- Changing the tuning mode (Tune Mode) ([page 36](#))

- Tuning in by entering the radio frequency (Direct Tune) ([page 37](#))

- Tuning in to radio stations and presetting them automatically (Auto Preset) ([page 38](#))

- Presetting the current broadcast station (Preset Memory) ([page 39](#))

- Specify a name for the preset broadcast station (Preset Name) ([page 40](#))

- Skipping preset broadcast stations (Preset Skip) ([page 41](#))

❑ Changing the tuning mode (Tune Mode)

You can change the mode for tuning into FM broadcasts. If you cannot tune in automatically with “Auto” mode, then change the mode to “Manual” and tune in manually.

1 Press **FM** to switch the input source to “FM”.

2 Press **OPTION**.

The option menu screen is displayed.

3 Use Δ / ∇ to select “Tune Mode”, then press **ENTER**.

[TV Screen]

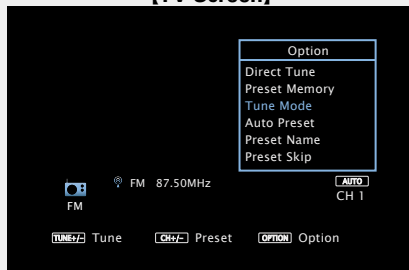

[Display of this unit]

Tune Mode

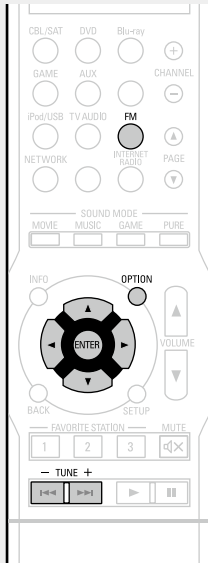

4 Use \triangleleft / \triangleright to select tuning mode, then press **ENTER**.

[TV Screen]

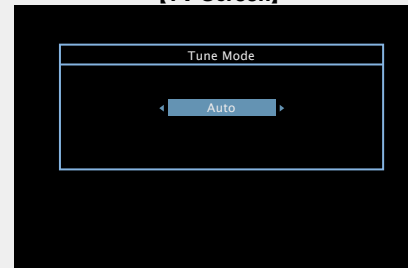

[Display of this unit]

Mode : ◀ Auto ▶

Auto Automatically tune to the station.

Manual Manually tune to the station.

5 Press **TUNE +** or **TUNE -** to select the station you want to hear.

The frequency changes in steps each time the button is pressed.



When tuning in stations manually, press and hold **TUNE +** or **TUNE -** to change frequencies continuously.

❑ Changing the screen display duration

Make this setting at “Audio Display” ([page 88](#)) in the menu. The default setting is “30s”.

Press Δ / ∇ / \triangleleft / \triangleright while the display is off to return to the original screen.

See overleaf

❑ **Tuning in by entering the radio frequency (Direct Tune)**

You can enter the receiving frequency directly to tune in.

1 Press **FM** to switch the input source to “FM”.

2 Press **OPTION**.
The option menu screen is displayed.

3 Use $\Delta \nabla$ to select “Direct Tune”, then press **ENTER**.
The direct tuner screen is displayed and “--” in the display flashes.

[TV Screen]

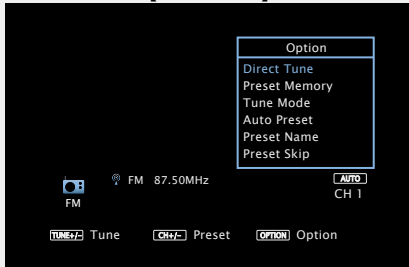

[Display of this unit]

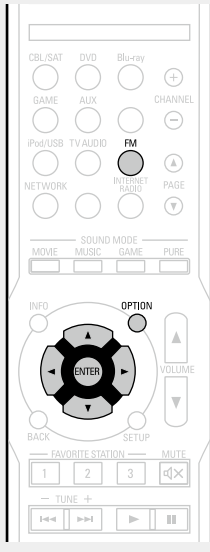
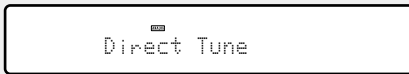

4 Use $\Delta \nabla$ to select a number and press \triangleright .
The screen that lets you enter the frequency is displayed.

[TV Screen]

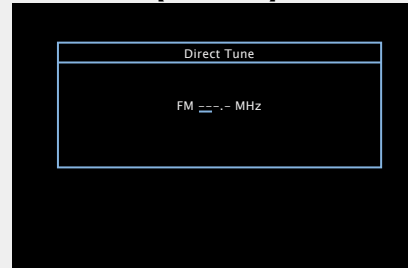

[Display of this unit]



• If \triangleleft is pressed, the immediately preceding input is cancelled.

5 Repeat step 3 and enter the frequency of the radio station you want to hear.

6 When setting is completed, press **ENTER**.
The preset frequency is tuned in.

See overleaf



Presetting broadcast stations

□ Tuning in to radio stations and presetting them automatically (Auto Preset)

Up to 56 stations can be preset.

If "Auto Preset" is performed after performing "Preset Memory", the "Preset Memory" settings will be overwritten.

1 Press **FM** to switch the input source to "FM".

2 Press **OPTION**.
The option menu screen is displayed.

3 Use Δ / ∇ to select "Auto Preset", then press **ENTER**.

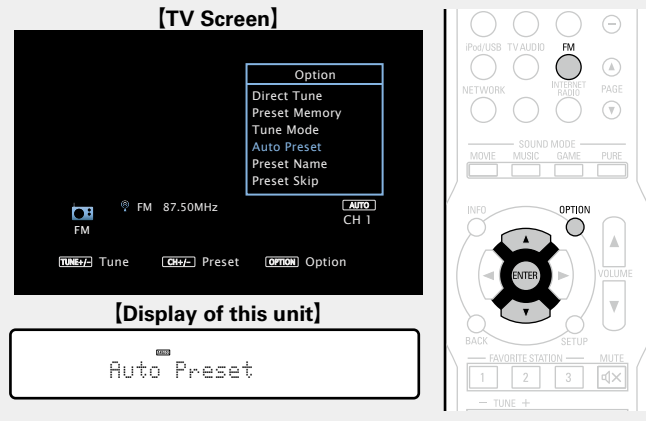

4 Press **ENTER**.
The unit starts to tune in to radio stations automatically and preset them.

[TV Screen]



[Display of this unit]

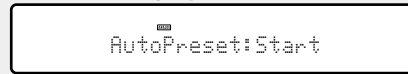

- When presetting is completed, "Completed" is displayed for about 5 seconds and the option menu screen turns off.

See overleaf



❑ Presetting the current broadcast station (Preset Memory)

Your favorite broadcast stations can be preset so that you can tune them in easily. Up to 56 stations can be preset.

1 Tune in the broadcast station you want to preset.

2 Press **OPTION**.
The option menu screen is displayed.

3 Use $\Delta \nabla$ to select “Preset Memory”, then press **ENTER**.
The list of already preset channels is displayed.

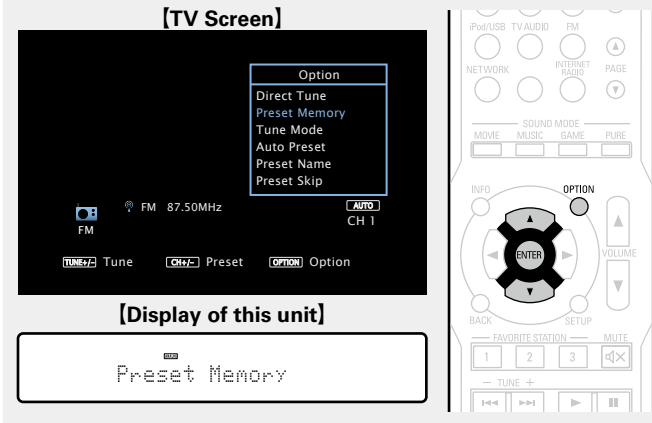

4 Use $\Delta \nabla$ to select the channel you want to preset, then press **ENTER**.

The current broadcast station that is preset.

- To preset other stations, repeat steps 1 to 4.

[TV Screen]

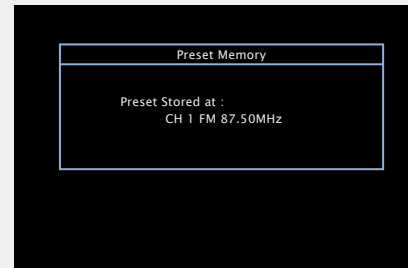
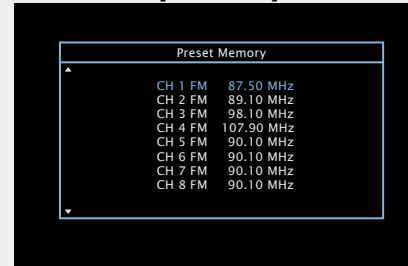

[Display of this unit]

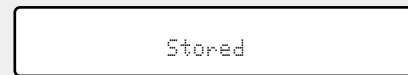
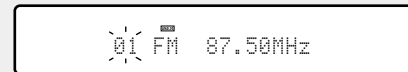

The channel numbers of broadcast stations set as “Preset Skip” (see page 41) are grayed out, but these stations can be preset. When grayed out channel numbers are preset, these are highlighted and the “Preset Skip” setting changes to “On”.

Channel	Default Settings
1 – 8	87.50 / 89.10 / 98.10 / 107.90 / 90.10 / 90.10 / 90.10 / 90.10 MHz
9 – 16	90.10 / 90.10 / 90.10 / 90.10 / 90.10 / 90.10 / 90.10 / 90.10 MHz
17 – 24	90.10 / 90.10 / 90.10 / 90.10 / 90.10 / 90.10 / 90.10 / 90.10 MHz
25 – 32	90.10 / 90.10 / 90.10 / 90.10 / 90.10 / 90.10 / 90.10 / 90.10 MHz
33 – 40	90.10 / 90.10 / 90.10 / 90.10 / 90.10 / 90.10 / 90.10 / 90.10 MHz
41 – 48	90.10 / 90.10 / 90.10 / 90.10 / 90.10 / 90.10 / 90.10 / 90.10 MHz
49 – 56	90.10 / 90.10 / 90.10 / 90.10 / 90.10 / 90.10 / 90.10 / 90.10 MHz

Listening to preset stations

Use **CHANNEL +, -** to select the desired preset channel.

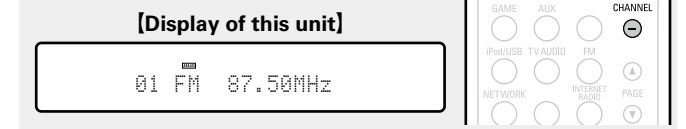

You can also select preset broadcast stations by pressing **TUNER PRESET CH +** or **TUNER PRESET CH -** on the unit.



Specify a name for the preset broadcast station (Preset Name)

You can set the name to the preset broadcast station or change it. Up to eight characters can be input.

1 Press **FM** to switch the input source to “FM”.

2 Press **OPTION**.

The option menu screen is displayed.

3 Use $\Delta \nabla$ to select “Preset Name”, then press **ENTER**.

The Preset Name screen is displayed.

[TV Screen]

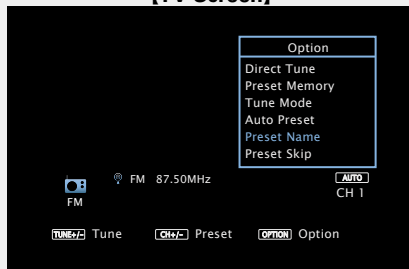

[Display of this unit]

Preset Name

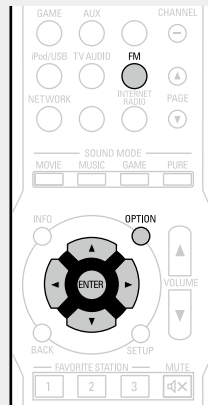

4 Use $\triangleleft \triangleright$ to select the group of the broadcast station you want to name, then press **ENTER**.

The screen that lets you edit the preset name is displayed.

- Each time $\triangleleft \triangleright$ is pressed, the setting is changed as shown below.

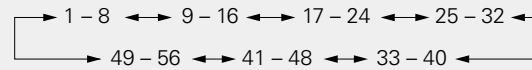

[TV Screen]

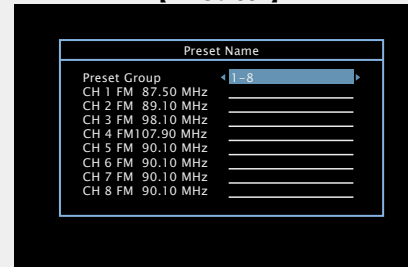

[Display of this unit]

GROUP : 1-8

5 Use $\Delta \nabla$ to select the broadcast station you want to name, then press **ENTER**.

[TV Screen]

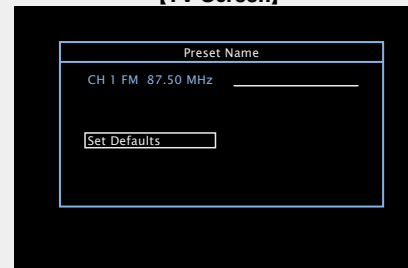

[Display of this unit]

1 FM 87.50MHz

6 Use $\Delta \nabla \triangleleft \triangleright$ to select a name label, then press **ENTER**.

The screen that lets you edit the preset name is displayed.

- If you select “Set Defaults”, then the unit returns to displaying the frequency.

7 Enter the characters, then press **OK**.

- For character input, see [page 79](#).

8 Press **BACK** twice.

The display returns to the playback screen.

❑ Skipping preset broadcast stations (Preset Skip)

You can set in advance, the stations you do not want to be displayed when tuning in, by groups or by stations. The preset skip setting is useful when tuning in, because only your favorite stations are displayed.

1 Press **FM** to switch the input source to “FM”.

2 Press **OPTION**.
The option menu screen is displayed.

3 Use $\Delta \nabla$ to select “Preset Skip”, then press **ENTER**.
The Preset Skip screen is displayed.

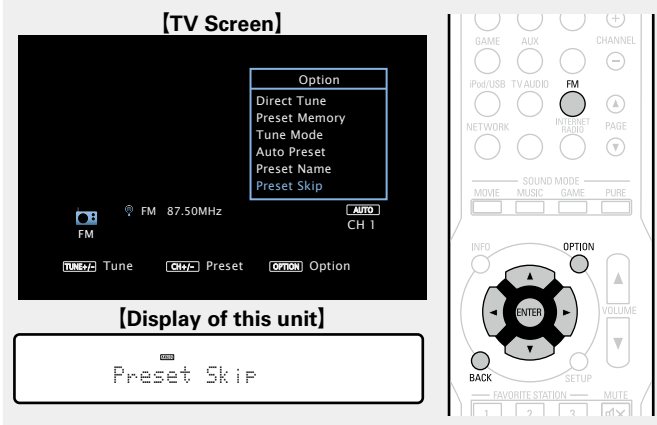

4-1 [To set the stations you want to skip by groups]

① Use $\triangleleft \triangleright$ to select the group of broadcast stations you want to skip.

- Each time $\triangleleft \triangleright$ is pressed, the setting is changed as shown below.

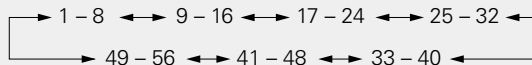

② Press Δ to select “Set No. * - * to Skip”, then press **ENTER**.

All broadcast stations in the group “* - *” you selected are not displayed.
(* are the selected group numbers)

③ Press **BACK**.

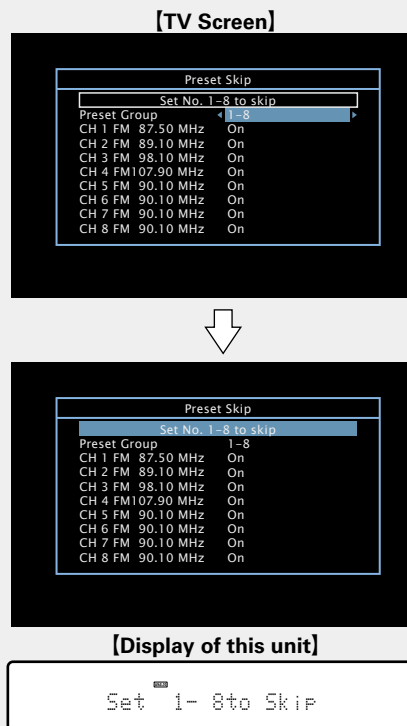

4-2 [To set the stations you want to skip by stations]

① Use $\triangleleft \triangleright$ to select the group of broadcast stations you want to skip.

- Each time $\triangleleft \triangleright$ is pressed, the setting is changed as shown below.

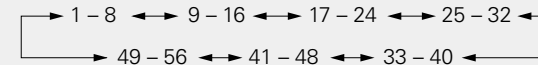

② Use $\Delta \nabla$ to select the broadcast station you want to skip.

③ Use $\triangleleft \triangleright$ to select “Skip”.
The station you selected is not displayed.

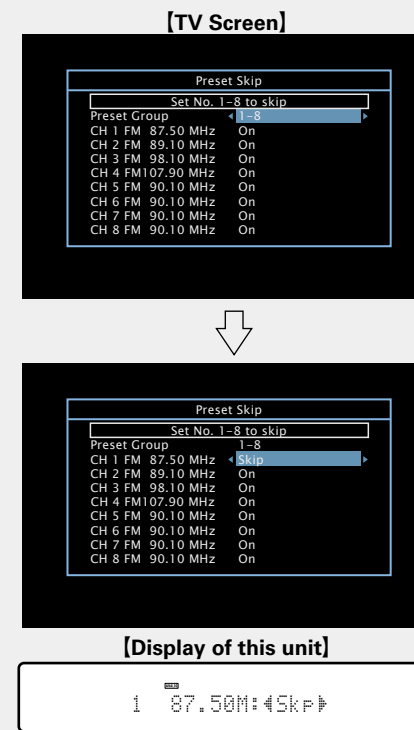

Basic version

Advanced version

Information



Cancelling preset skip

- 1 While the Preset Skip screen is displayed, use $\triangleleft \triangleright$ to select a group containing a broadcast station to cancel the skip for.
- 2 Use $\triangle \nabla$ to select a broadcast station to cancel the skip for.

[TV Screen]

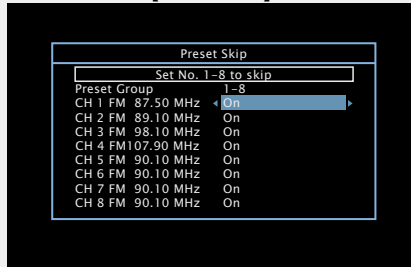

[Display of this unit]

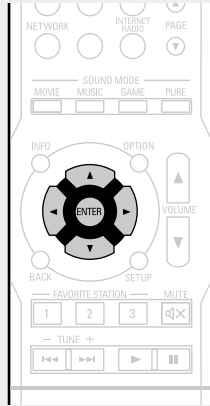

- 3 Use $\triangleleft \triangleright$ to select "On".
The skip is cancelled.

NOTE

You cannot cancel the skip for each group.

FM operation buttons

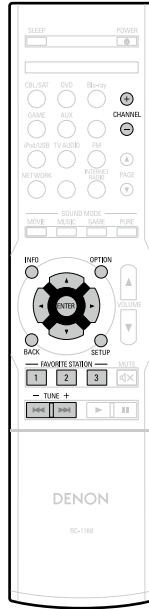

Operation buttons	Function
CHANNEL +, -	Preset channel selection
INFO	Display of information such as the source name, volume, and sound mode name
OPTION	Switch tuning modes / Direct frequency tuning / Preset Memory / Auto Preset / Preset Name / Preset Skip
$\triangle \nabla \triangleleft \triangleright$	Cursor operation
ENTER	Enter
BACK	Return
SETUP	Setup menu
FAVORITE STATION 1 - 3	Add/call up favorites (see page 60)
TUNE +, -	Tuning (up/down)



Listening to internet radio

Internet radio refers to radio broadcasts distributed over the Internet. Internet radio stations from around the world can be received.

Important information

The broadcast station types and specifications supported by this unit for playback are as follows.

[Playable broadcast station types]

Supported file types	Internet radio
WMA (Windows Media Audio)	✓
MP3 (MPEG-1 Audio Layer-3)	✓

[Playable broadcast station specifications]

	Sampling frequency	Bit rate	Extension
WMA (Windows Media Audio)	32/44.1/48 kHz	48 – 192 kbps	.wma
MP3 (MPEG-1 Audio Layer-3)	32/44.1/48 kHz	32 – 320 kbps	.mp3

Listening to internet radio

1 Prepare for playback.

- ① Check the network environment, then turn on this unit's power (☞ [page 18](#) "Connecting to a home network (LAN)").
- ② If settings are required, make the "Settings" (☞ [page 99](#)).

2 Press NETWORK.

- You can also press **INTERNET RADIO** to select the input source "Internet Radio" directly.

3 Use Δ ∇ \triangleleft \triangleright to select "Internet Radio", then press ENTER.

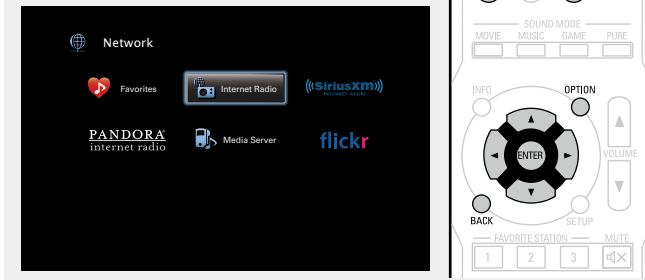

4 Use Δ ∇ to select the item you want to play, then press ENTER or \triangleright .



- *******
(Country name) Displays typical Internet radio stations your country.
- Search Stations** Displays all Internet radio stations that this unit can tune in to.
- Search Podcasts** Displays Internet radio stations in the podcasts that this unit can tune in to.
- Recommended Stations** Displays recommended Internet radio stations.
- radiodnon.com** Displays Internet radio stations added to favorites in vTuner. For instructions on how to add to favorites in vTuner, see "Using vTuner to add Internet radio stations to favorites" (☞ [page 45](#)).
- Recently Played** Displays recently played Internet radio stations. Up to 20 stations stored in "Recently Played".
- Search by Keyword** Displays Internet radio stations searched by keyword. For character input, see [page 79](#).

5 Repeat step 4 until the station list is displayed.

The station list is displayed.

6 Use Δ ∇ to select the station, then press ENTER or \triangleright .

Playback starts once buffering reaches "100%".

See overleaf

❑ Adjusting the sound quality (Restorer)

Make this setting at "Restorer" ([page 83](#)) in the menu.

You can use the "Restorer" function to restore to a state close to the audio before compression while correcting the bass feel to enjoy a richer playback experience. The default setting is "Mode3 (Low)".

❑ Switching the screen display

Press **STATUS** on the main unit.

The display switches between track title and radio station name each time the button is pressed.

❑ Going back to the previous screen

Press **◀** or **BACK**.

❑ Changing the screen display duration

Make this setting at "Audio Display" ([page 88](#)) in the menu. The default setting is "30s".

Press **△▽◀▶** while the display is off to return to the original screen.



- There are many Internet radio stations on the Internet, and the quality of the programs they broadcast as well as the bit rate of the tracks varies widely.

Generally, the higher the bit rate, the higher the sound quality, but depending on the communication lines and server traffic, the music or audio signals being streamed may be interrupted. Inversely, lower bit rates mean a lower sound quality but less tendency for the sound to be interrupted.

- "Radio station server full" or "Connection down" is displayed if the station is busy or not broadcasting.
- On this unit, folder and file names can be displayed as titles. Any characters that cannot be displayed are replaced with "." (period).

NOTE

The radio station database service may be suspended without notice.

Operations available through the OPTION button

Press the **OPTION** button to display a menu of functions that can be used on the TV screen. Select the function you want to use from this menu. You can easily find and use the desired function.

❑ **Searching content with keywords (Text Search)** ([page 58](#))

❑ **Add to favorites from the Option menu (Favorites Memory)** ([page 60](#))

❑ **Playing back music and a favorite picture at the same time (Picture View)** ([page 61](#))

❑ Playing the last played Internet radio station

This unit memorizes the last played Internet radio station. If you press **INTERNET RADIO** to switch to the Internet radio function from another input source, the last Internet radio station you listened to is played.

Press INTERNET RADIO.

The source switches to "Internet Radio" and the last played radio station plays.

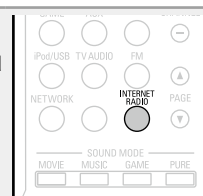

❑ Using vTuner to add Internet radio stations to favorites

There are many Internet radio stations in the world, and this unit can tune into these stations. But finding the radio station you want to hear may be difficult, because there are too many stations. If this is the case, then please use vTuner, an Internet radio station search website specifically designed for this unit. You can use your PC to search Internet radio stations and add them as your favorites. This unit can play radio stations added to vTuner.

1 Check the MAC address of this unit (☞ page 98).

The screen that lets you edit the preset name is displayed.

MAC address:

- The MAC address is necessary when you create an account for vTuner.

2 Use your PC to access the vTuner website (<http://www.radiodenon.com>).

The vTuner login screen is displayed.

3 Enter the MAC address of this unit, then click “Go”.

The account creation screen is displayed.

4 Enter your E-mail address and a password of your choice.

The account is registered and you can now log in.

5 Enter your account information (E-mail address and password) and log in.

The top menu of vTuner is displayed.

6 Select the search criteria (genre, region, language, etc.) of your choice.

The list of radio stations matching the criteria is displayed.

- You can also enter a keyword to search for a station you want to hear.

7 Select the radio station of your choice from the list, and then click the Add to Favorites icon.

The screen that lets you create a favorite group is displayed.

8 Enter the name of the favorite group, then click “Go”.

A new favorite group that includes the selected radio station is created.

- Internet radio stations added to favorites in vTuner can be played from “radiodenon.com” (☞ page 43) with this unit.

❑ Internet radio operation buttons

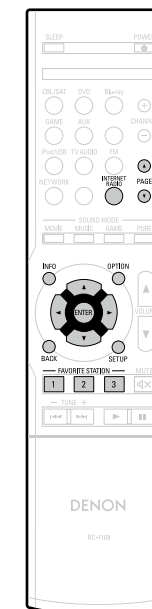

Operation buttons	Function
INTERNET RADIO	Last played internet radio station
PAGE ▲▼	Page search
INFO	Display of information such as the source name, volume, and sound mode name
OPTION	Text Search / Favorites Memory / Picture View
△▽◀▶	Cursor operation
ENTER (Press and release)	Enter
ENTER (Press and hold)	Stop
BACK	Return
SETUP	Setup menu
FAVORITE STATION 1 – 3	Add/call up favorites (☞ page 60)

Playing back files stored on a PC and NAS

This unit can play back music files and playlists (m3u, wpl) stored on a PC and on Network Attached Storage (NAS) that supports DLNA.

Important information

- The network audio playback function of this unit connects to the server using technologies shown below.
 - Windows Media Player Network Sharing Service
 - Windows Media DRM10
- File types that this unit can play back and specifications are shown below.

[Supported file types]

Supported file types	Media server *1
WMA (Windows Media Audio)	✓
MP3 (MPEG-1 Audio Layer-3)	✓
WAV	✓
MPEG-4 AAC	✓*2
FLAC (Free Lossless Audio Codec)	✓
JPEG	✓

A server or server software compatible with distribution in the corresponding formats is required to play music files via a network.

*1 Media server

- This unit is compatible with MP3 ID3-Tag (Ver. 2) standard.
- This unit can show the artwork that was embedded by using MP3 ID3-Tag Ver. 2.3 or 2.4.
- This unit is compatible with WMA META tags.
- If the image size (pixels) of an album artwork exceeds 500 × 500 (WMA/MP3/WAV/FLAC) or 349 × 349 (MPEG-4 AAC), then music may not be played back properly.

*2 Only files that are not protected by copyright can be played on this unit.

Content downloaded from pay sites on the Internet are copyright protected. Also, files encoded in WMA format when ripped from a CD, etc. on a computer may be copyright protected, depending on the computer's settings.

NOTE

File types that this unit does not support are not displayed.

[Specifications of supported files]

	Sampling frequency	Bit rate	Extension
WMA (Windows Media Audio)	32/44.1/48 kHz	48 – 192 kbps	.wma
MP3 (MPEG-1 Audio Layer-3)	32/44.1/48 kHz	32 – 320 kbps	.mp3
WAV	32/44.1/48 kHz	–	.wav
MPEG-4 AAC	32/44.1/48 kHz	16 – 320 kbps	.aac/ .m4a/ .mp4
FLAC (Free Lossless Audio Codec)	32/44.1/48/88.2/96 kHz	–	.flac



Applying media sharing settings

Here, we apply the settings to share music files stored on a PC and NAS on the network.

Sharing media stored in PC

If you are using a media server, be sure to apply this setting first.

When using Windows Media Player 12 (Windows 7)

NOTE

Perform this procedure after changing the control panel display to "Category".

- 1** In the PC's "Control Panel", select "Network and Internet" - "Choose homegroup and sharing options".
- 2** Select the "Stream my pictures, music, and videos to all devices on my home network" check box and select "Choose media streaming options".
- 3** Select "Allowed" in the drop-down list for "AVR-1613".
- 4** Select "Allowed" in the drop-down list for "Media programs on this PC and remote connections...".
- 5** Click "OK" to finish.

When using Windows Media Player 11

- 1** Start up Windows Media Player 11 on the PC.
- 2** Select "Media Sharing" in the "Library".
- 3** Click the "Share my media" check box, select "AVR-1613", and then click "Allow".
- 4** As you did in step 3, select the icon of the device (other PCs and mobile devices) you want to use as a media controller, and then click "Allow".
- 5** Click "OK" to finish.

Sharing media stored in NAS

Change settings on the NAS to allow this unit and other devices (PCs and mobile devices) used as media controllers to access the NAS. For details, see the owner's manual that came with the NAS.

Playing back files stored on a PC and NAS

Use this procedure to play music files, image files or playlists.

1 Prepare for playback.

- ① Check the network environment, then turn on this unit's power (☞ [page 18](#) "Connecting to a home network (LAN)").
- ② If settings are required, make the "Settings" (☞ [page 99](#)).
- ③ Prepare the computer (☞ Computer's operating instructions).

2 Press NETWORK.

3 Use $\Delta \nabla \triangleleft \triangleright$ to select "Media Server", then press ENTER.

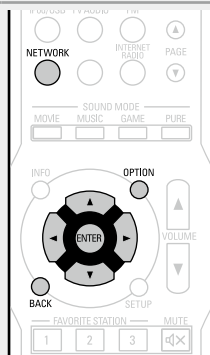
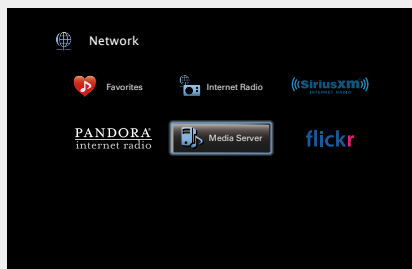

4 Use $\Delta \nabla \triangleleft \triangleright$ to select the server including the file to be played, then press ENTER or \triangleright .

5 Use $\Delta \nabla$ to select the search item or folder, then press ENTER or \triangleright .

6 Repeat step 4 until the file is displayed.

7 Use $\Delta \nabla$ to select the file, then press ENTER or \triangleright . Playback starts once buffering reaches "100%".

Adjusting the sound quality (Restorer)

Make this setting at "Restorer" (☞ [page 83](#)) in the menu. You can use the "Restorer" function to restore to a state close to the audio before compression while correcting the bass feel to enjoy a richer playback experience. The default setting is "Mode3 (Low)".

Switching the screen display

Press **STATUS** on the main unit. The display switches between track title, artist name, and album title each time the button is pressed.

Going back to the previous screen

Press \triangleleft or **BACK**.

Changing the screen display duration

Make this setting at "Audio Display" (☞ [page 88](#)) in the menu. The default setting is "30s". Press $\Delta \nabla \triangleleft \triangleright$ while the display is off to return to the original screen.



- When a WMA (Windows Media Audio), MP3 or MPEG-4 AAC file includes album art data, the album art can be displayed while the music files are playing.
- If you use Ver.11 or later of Windows Media Player, the album art for WMA files can be displayed.
- WMA Lossless files can be played when using a server supporting transcoding, such as Windows Media Player Ver. 11 or later.

NOTE

- Depending on the size of the still picture (JPEG) file, some time may be required for the file to be displayed.
- The order in which the tracks/files are displayed depends on the server specifications. If the tracks/ files are not displayed in alphabetical order due to the server specifications, searching by the first letter may not work properly.

Operations available through the OPTION button

Press the **OPTION** button to display a menu of functions that can be used on the TV screen. Select the function you want to use from this menu. You can easily find and use the desired function.

❑ **Searching content with keywords (Text Search)** (👉 page 58)

❑ **Performing repeat playback (Repeat)** (👉 page 59)

❑ **Performing random playback (Random)** (👉 page 59)

❑ **Add to favorites from the Option menu (Favorites Memory)** (👉 page 60)

❑ **Playing back music and a favorite picture at the same time (Picture View)** (👉 page 61)

❑ **Playing back still images in sequential order (Slideshow)** (👉 page 61)

❑ Media server operation buttons

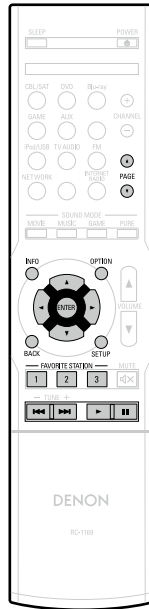

Operation buttons	Function
PAGE ▲▼	Page search
INFO	Display of information such as the source name, volume, and sound mode name
OPTION	Text Search / Repeat playback / Random playback / Favorites Memory / Picture View / Slideshow
△▽◀▶	Cursor operation / Auto search (cue, △▽)
ENTER (Press and release)	Enter
ENTER (Press and hold)	Stop
BACK	Return
SETUP	Setup menu
FAVORITE STATION 1 – 3	Add/call up favorites (👉 page 60)
◀◀ ▶▶	Auto search (cue)
▶	Playback
⏸	Pause

Using online services

This unit supports playback of the online services shown below.



□ About Flickr (👉 page 51)

Flickr is an online photograph sharing service that started in 2004. You can use this unit to view photographs that have been made public by Flickr users. You do not need an account to use Flickr. To view photographs that you recorded yourself, you need an account in order to upload these photographs to the Flickr server. For details, see the Flickr homepage.

<http://www.flickr.com/>



□ About Pandora (👉 page 53)

Pandora is an automated music recommendation and Internet radio service created by the Music Genome Project.

When you first listen to Pandora, it is necessary to subscribe to a Pandora account at the Pandora homepage by your PC and register this machine. See the Pandora homepage for details.

<http://www.pandora.com/denon>



□ About SiriusXM (👉 page 56)

Enjoy anywhere access to the unparalleled content of SiriusXM.

Whether on your computer, smartphone, tablet, Lynx Portable Enjoy anywhere access to the unparalleled content of SiriusXM.

Whether on your computer, smartphone, tablet, Lynx Portable Radio, or compatible Internet-connected device, you don't need to be in your vehicle to enjoy SiriusXM.

For details, see the SiriusXM homepage.

<http://www.siriusxm.com>

Viewing photographs on the Flickr site

You can view photographs shared by particular users, or all of the photographs shared on Flickr.

Viewing photographs shared by particular users

1 Prepare for playback.

- ① Check the network environment, then turn on this unit's power (see [page 18](#) "Connecting to a home network (LAN)").
- ② If settings are required, make the "Settings" (see [page 99](#)).
- ③ Access the following website from your PC and obtain a Flickr account.
<http://www.flickr.com/>

2 Press NETWORK.

3 Use $\Delta \nabla \triangleleft \triangleright$ to select "Flickr", then press ENTER.

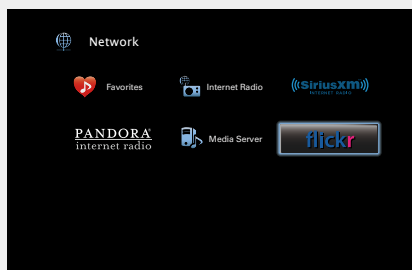

4 Use $\Delta \nabla$ to select "Add Flickr Contact", then press ENTER or \triangleright .

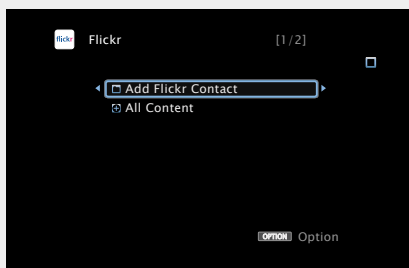

5 In "Contact", add the screen name (user name you want to view) you want to add.

- For character input, see [page 79](#).

6 After inputting the "Contact", press **OK**.

The screen name is added to "Contact", and the screen name you entered in Step 5 is displayed on the top screen of Flickr.

- If you enter a screen name that does not exist, "The Flickr Contact you entered could not be found" is displayed. Check and enter the correct screen name.

7 Use $\Delta \nabla$ to select the folder, and then press ENTER or \triangleright .

Favorites Displays the favorite photographs of the specified user.

Photostream Displays a list of shared photographs.

PhotoSets Displays the folder (photograph album) list.

Contacts Displays the screen name used by the specified user in Contacts.

Remove this Contact Deletes a user from Flickr Contact.

Add this Contact Adds a user from Flickr Contact.

8 Use $\Delta \nabla$ to select the file, and then press ENTER or \triangleright .

The selected file is displayed.

Going back to the previous screen

Press \triangleleft or **BACK**.

Operations available through the OPTION button

Press the **OPTION** button to display a menu of functions that can be used on the TV screen. Select the function you want to use from this menu. You can easily find and use the desired function.

Playing back still images in sequential order (Slideshow) (see [page 61](#))

❑ Viewing all photographs on Flickr

1 Use Δ / ∇ to select “All Content”, then press **ENTER** or \triangleright .

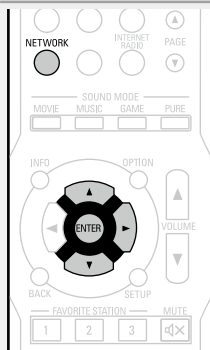
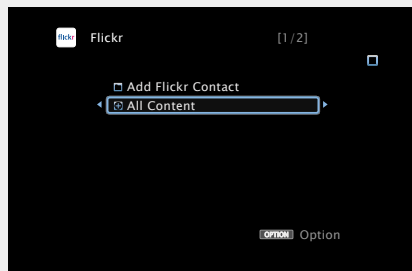

2 Use Δ / ∇ to select the folder, and then press **ENTER** or \triangleright .

Interestingness Displays photographs that are popular from the number of user comments or number of times they are added as favorites.

Recent Displays the most recently added photographs.

Search by text Search for photographs by keyword.

3 Use Δ / ∇ to select the file, and then press **ENTER** or \triangleright .
The selected file is displayed.

NOTE

Depending on the file format, some photographs cannot be viewed.

❑ Flickr operation buttons

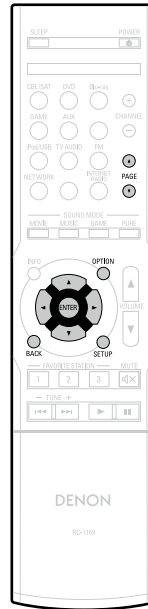

Operation buttons	Function
PAGE Δ / ∇	Page search
INFO	Display of information such as the source name, volume, and sound mode name
OPTION	Slideshow
Δ / ∇ / \triangleleft / \triangleright	Cursor operation / Auto search (cue, Δ / ∇)
ENTER (Press and release)	Enter
ENTER (Press and hold)	Stop
BACK	Return
SETUP	Setup menu

Listening to Pandora

1 Prepare for playback.

- ① Check the network environment, then turn on this unit's power (☞ [page 18](#) "Connecting to a home network (LAN)").
- ② If settings are required, make the "Settings" (☞ [page 99](#)).
- ③ Complete step 4 and obtain a Pandora account.
 - If you already have a Pandora account, you do not need to obtain a new account. Use your existing Pandora account.

2 Press NETWORK.

3 Use $\Delta \nabla \triangleleft \triangleright$ to select "Pandora", then press ENTER.

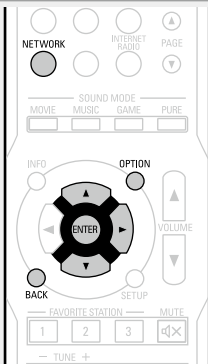
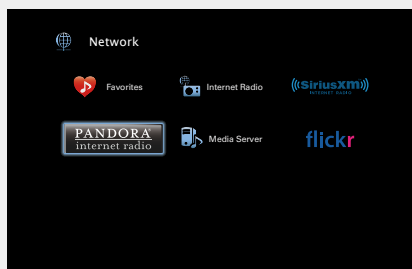

4 If you have a Pandora account, use $\Delta \nabla$ to select "I have a Pandora account", then press ENTER or \triangleright .

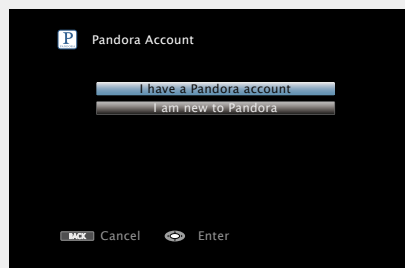

- If you do not have a Pandora account, press ∇ to select "I am new to Pandora". The URL of Pandora and activation code are displayed. Access the Pandora web page from your PC and register the displayed activation code and account information. Then press ENTER.

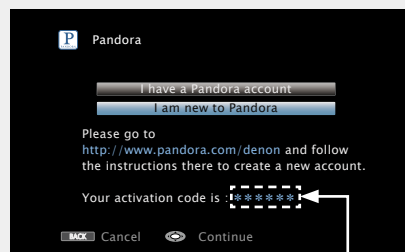

This is an identification code required to register your purchased product to the Pandora service.
This code is used to obtain your account.

5 Input "Email address" and "Password".

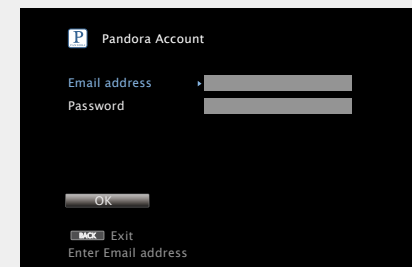

- For character input, see [page 79](#).

6 After inputting the "Email address" and "Password", select "OK", then press ENTER.

If the "Email address" and "Password" match, the top menu for Pandora is displayed.

NOTE

Press **BACK** to cancel the input. When "Cancel input?" is displayed, select "Yes", then press **ENTER**.

Creating an original radio station

You can create up to 100 original radio stations.

1 Use Δ / ∇ to select “New Station”, then press ENTER or \triangleright .

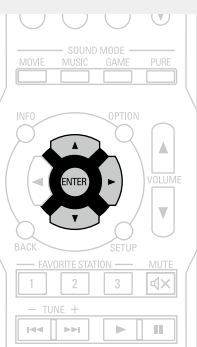

2 Input a track or artist name, then press **OK**.

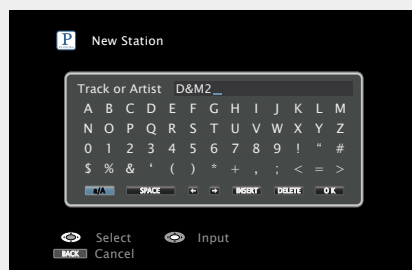

• For character input, see [page 79](#).

3 Use Δ / ∇ to select “Search by Artist” or “Search by Track”, then press ENTER.

You can search and display a list by track or artist.

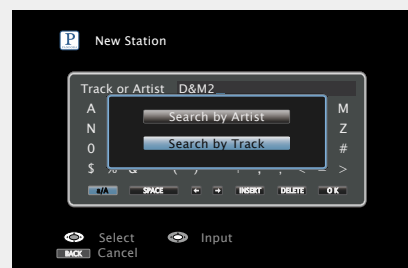

4 Press Δ / ∇ , select a file (e.g. D&M2) from the list, and press ENTER or \triangleright .

Selected file is played back.

“Radio” is added to the end of a filename, and your original radio station is created (e.g. D&M2 Radio).

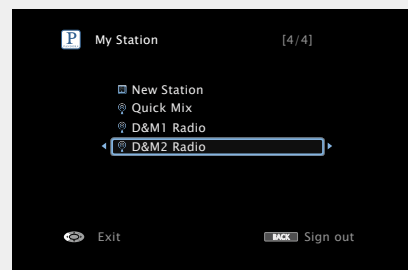

Listening to a created radio station

Listening to a created radio station (e.g. D&M2 Radio)

By specifying your favorite track or artist name, music that has a similar rhythm or sound is chosen and streamed.

Use Δ / ∇ and select the radio station (“D&M2 Radio”) that you want to listen to, and press ENTER or \triangleright .

In Pandora, you can search for the track name or artist name using “D&M2” as a keyword. When the search is complete, tracks that have a similar rhythm or sound are streamed.

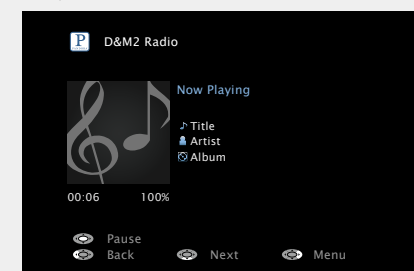
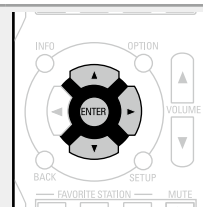

Listening to created radio stations at random

Use Δ / ∇ to select “Quick Mix”, then press ENTER or \triangleright .

Created radio stations are selected at random, and tracks are streamed.

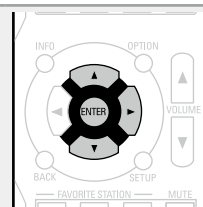

Arranging tracks within radio stations

You can sort tracks by operating the Pandora menu screen while a track is playing.

Press **▷** while a track is playing.
The Pandora menu screen is displayed.

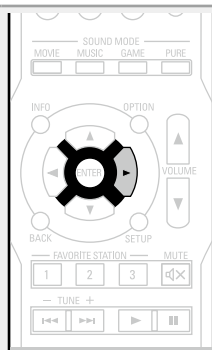
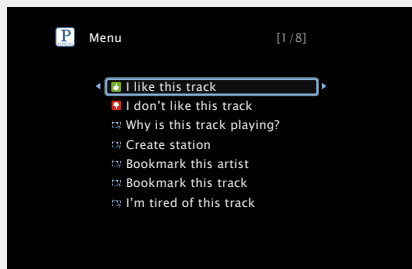

- I like this track**
 - Press when you like the track that is being played.
 - It will return to the Play Screen. And (Thumbs up) icon is displayed. (The icon is not displayed on the next track.)
- I don't like this track**
 - Press when you don't like the track that is being played.
 - It will return to the Play Screen. And (Thumbs down) icon is displayed. (The icon is not displayed on the next track.)
- Why is this track playing?**
 - Displays the reason why Pandora selected this track.
- Create station**
 - Creates a Station for the Track or Artist being played.
- Bookmark this artist**
 - Bookmarks the artist currently being played.
 - You can check on a computer or iPhone etc.
 - For details, see the Pandora web page.
- Bookmark this track**
 - Bookmarks the track currently being played.
 - You can check on a computer or iPhone etc.
 - For details, see the Pandora web page.
- I'm tired of this track**
 - Press when you don't like the track that is being played.
 - The track will not be played for 1 month.
- Delete this station**
 - Press when you want to delete the station that is being played.

NOTE

- You can Skip up to 6 Tracks that are being played back within 1 hour.
- You can create up to 100 New Stations (radio stations).

Sign out

Disassociate this unit from your Pandora account.

1 While the Pandora top menu is displayed, press **BACK**.

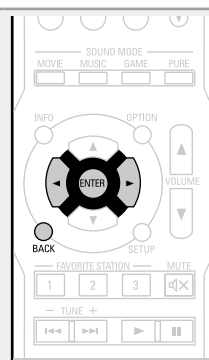
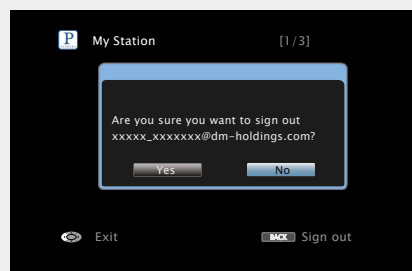

2 When the popup menu appears, use **◁ ▷** to select "Yes", then press **ENTER**.

Pandora operation buttons

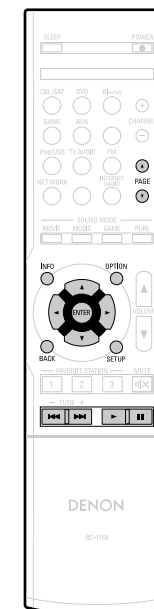

Operation buttons	Function
PAGE ▲▼	Page search
INFO	Display of information such as the source name, volume, and sound mode name
△▽◁▷	Cursor operation / Auto search (cue, △▽)
ENTER (Press and release)	Enter
ENTER (Press and hold)	Stop
BACK	Return
SETUP	Setup menu
◁◁ ▷▷	Auto search (cue)
▶	Playback
⏸	Pause

Listening to SiriusXM Satellite Radio

Over 120 channels of the SiriusXM programming you love, including commercial-free music plus sports, talk, news and entertainment. Listen anywhere on your computer or smartphone.

1 Prepare for playback.

- ① Check the network environment, then turn on this unit's power (see [page 18](#) "Connecting to a home network (LAN)").
- ② If settings are required, make the "Settings" (see [page 99](#)).
- ③ Access the following website from your PC and obtain a SiriusXM account.
<http://www.siriusxm.com>
 - If you already have a SiriusXM account, you do not need to obtain a new account. Select "Sign in" in step 4, and enter your existing SiriusXM account.

2 Press NETWORK.

3 Use $\Delta \nabla \triangleleft \triangleright$ to select "SiriusXM", then press ENTER.

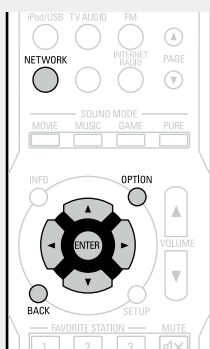
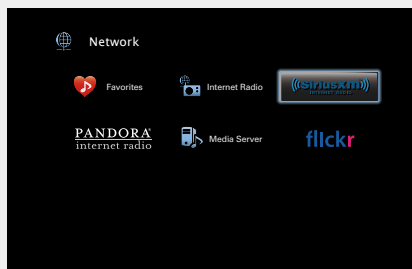

4 Select "Sign in", then press ENTER.

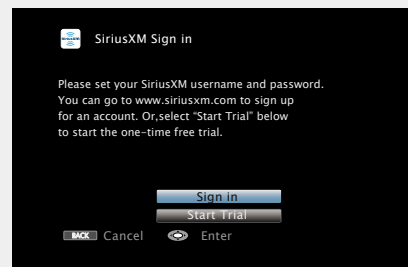

5 Input the "Username" and "Password".

- For character input, see [page 79](#).

6 Select the "Sign in", and then press ENTER.

The top menu of SiriusXM is displayed.



7 Use $\Delta \nabla$ to select the genre, then press ENTER or \triangleright .

8 Use $\Delta \nabla$ to select the file, and then press ENTER or \triangleright .

The selected file is displayed.

- **Going back to the previous screen**
Press \triangleleft or **BACK**.

❑ Sign out

Disassociate this unit from your SiriusXM account.

1 While the SiriusXM top menu is displayed, press **BACK**.

2 When the popup menu appears, use **◀ ▶** to select “Yes”, then press **ENTER**.

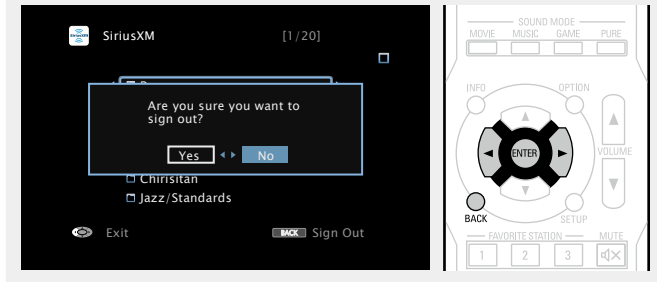

❑ SiriusXM operation buttons

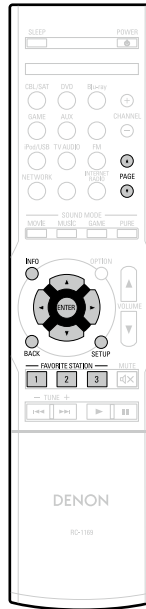

Operation buttons	Function
PAGE ▲▼	Page search
INFO	Display of information such as the source name, volume, and sound mode name
◀▼▶▶	Cursor operation
ENTER (Press and release)	Enter
ENTER (Press and hold)	Stop
BACK	Return
SETUP	Setup menu
FAVORITE STATION 1 – 3	Add/call up favorites (see page 60)

Convenient functions

Here, we explain how to use convenient functions for NETWORK sources and USB sources. The source names under the titles of each function's description are sources that allow use of these functions.

❑ **Searching content with keywords (Text Search)** (👉 page 58)

❑ **Performing repeat playback (Repeat)** (👉 page 59)

❑ **Performing random playback (Random)** (👉 page 59)

❑ **Favorites function** (👉 page 60)

❑ **Playing back music and a favorite picture at the same time (Picture View)** (👉 page 61)

❑ **Playing back still images in sequential order (Slideshow)** (👉 page 61)

Searching content with keywords (Text Search)

USB | Internet Radio | Media Server

1 While content is playing, press **OPTION**.
The option menu screen is displayed.

2 Use Δ / ∇ to select "Text Search", then press **ENTER**.
The keyboard input screen is displayed.

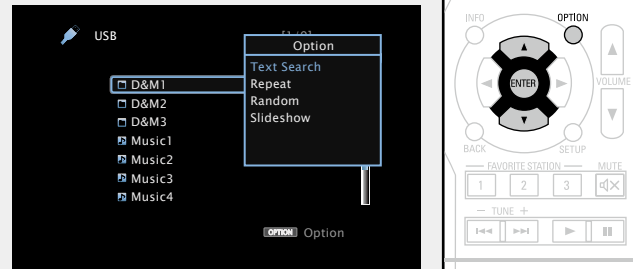

3 Enter the first character of the Internet radio station or file you want to search for, and then press **OK**.

• For character input, see [page 79](#).

NOTE

"Text Search" may not work for some lists.

❑ Playing back a search result content

Use Δ / ∇ to select the content you want to play, and then press **ENTER** or \triangleright .

Playback starts.

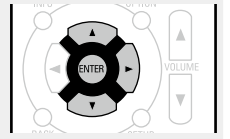

Performing repeat playback (Repeat)

USB Media Server

1 While content is playing, press **OPTION**.
The option menu screen is displayed.

2 Use Δ / ∇ to select “Repeat”, then press **ENTER**.

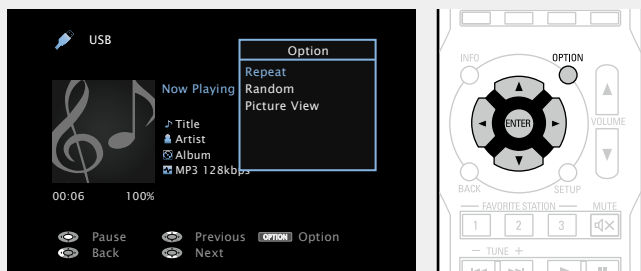

3 Use \triangleleft / \triangleright to select repeat playback mode.

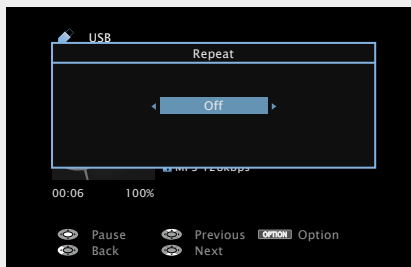

• Each time \triangleleft / \triangleright is pressed, the setting is changed as shown below.



Off Repeat playback mode is canceled.

One A file being played is played repeatedly.

All All files in the folder currently being played are played repeatedly.

4 Press **ENTER**.
The display returns to the playback screen.

Performing random playback (Random)

USB Media Server

1 While content is playing, press **OPTION**.
The option menu screen is displayed.

2 Use Δ / ∇ to select “Random”, then press **ENTER**.

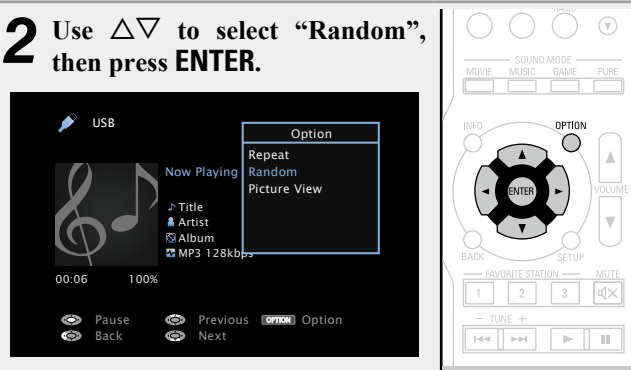

3 Use \triangleleft / \triangleright to select random playback mode.

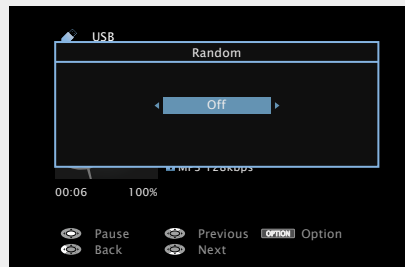

• Each time \triangleleft / \triangleright is pressed, the setting is changed as shown below.



Off Disable random playback.

On Enable random playback.

4 Press **ENTER**.
The display returns to the playback screen.



The random playback randomly selects a track to play back from all tracks every time a track ends. Therefore, the same track may be played back consecutively.

Favorites function

There are two ways to add content to favorites:

- ① Add to favorites from the Option menu
- ② Add to the **FAVORITE STATION** button

❑ Add to favorites from the Option menu (Favorites Memory)

Internet Radio **Media Server**

You can add up to 100 items as favorites for all sources (Internet Radio and Media Server).

1 While content is playing, press **OPTION**.

The option menu screen is displayed.

2 Use $\Delta \nabla$ to select "Favorites Memory", then press **ENTER**.

"Favorites Added" is displayed, and the current content is added to favorites.

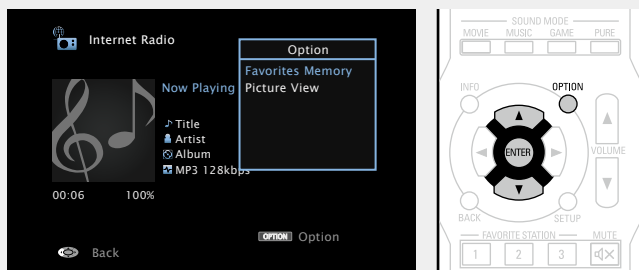

- The display returns to the playback screen when the procedure is completed.

Playing back content added in "Favorite Memory"

1 Press **NETWORK**.

2 Use $\Delta \nabla \triangleleft \triangleright$ to select "Favorites", then press **ENTER**.

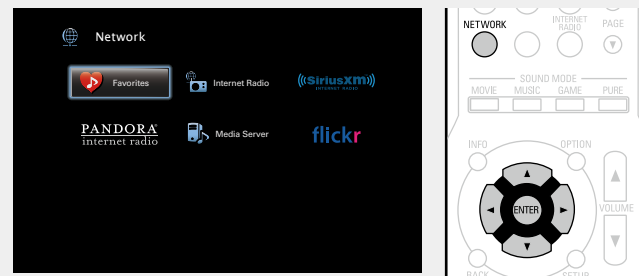

3 Use $\Delta \nabla$ to select the content you want to play, and then press **ENTER** or \triangleright . Playback starts.

❑ Adding to the FAVORITES STATION button

You can add up to three types of content.

NOTE

- Please note that if you add new content to a number that already contains content, the older content is deleted.
- The following operations update the database on the media server, which may make the added music files unplayable.
 - When you quit the media server and then restart it.
 - When music files are deleted or added on the media server.
- When using an ESCIENT server, place "ESCIENT" before the server name.

While content is playing, press and hold one of the FAVORITE STATION 1-3 buttons for more than 3 seconds.

The content is added to the button you pressed.

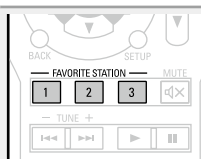

Contents that can be added to the **FAVORITE STATION** button differ depending on the input source.

Input source	Contents that can be added
FM	Input source / Radio station
Internet Radio	Input source / Internet Radio station
Media Server	Input source / Track
Flickr	Input source
Pandora	Input source
SiriusXM	Input source
Favorites	Input source

Playing back content added to the FAVORITES STATION button

You can easily call up content by pressing the **FAVORITE STATION** button.

Press one of the FAVORITE STATION 1-3 buttons that you added content to.

Playback starts.

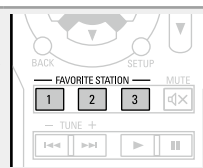

See overleaf

Deleting content added to favorites (Remove Favorites)

1 Press **NETWORK**.

2 Use $\Delta \nabla \triangleleft \triangleright$ to select "Favorites", then press **ENTER**.

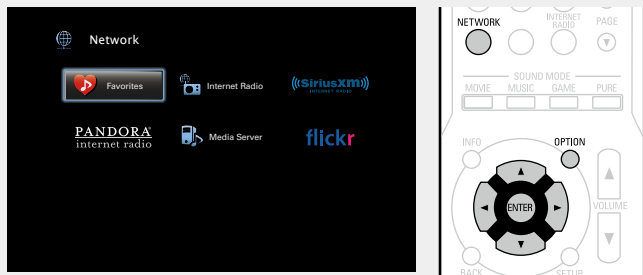

3 Use $\Delta \nabla$ to select the content you want to delete from favorites, then press **OPTION**.
The option menu screen is displayed.

4 Use $\Delta \nabla$ to select "Remove Favorites", then press **ENTER**.

"Favorites removed" is displayed, and the selected content is deleted from favorites.

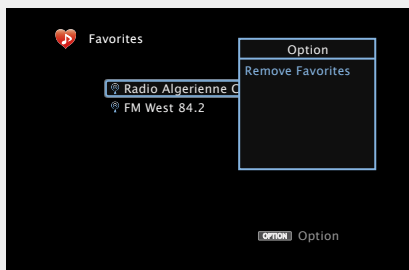

• The display returns to the original screen when the procedure is completed.

Playing back music and a favorite picture at the same time (Picture View)

USB **Internet Radio** **Media Server**

1 Play back a still picture (☞ [page 51](#)).

2 Play back a music file or Internet radio station (☞ [page 43, 48](#)).

3 Press **OPTION**.
The option menu screen is displayed.

4 Use $\Delta \nabla$ to select "Picture View", then press **ENTER**.
The option menu disappears, and the picture you were viewing is shown on the screen.



Playing back still images in sequential order (Slideshow)

You can play back still image (JPEG) files stored on a USB memory device or media server and pictures on Flickr website as a slide show. The display time can also be set.

USB **Media Server** **Flickr**

1 Press **OPTION**.
The option menu screen is displayed.

2 Use $\Delta \nabla$ to select "Slideshow", then press **ENTER**.

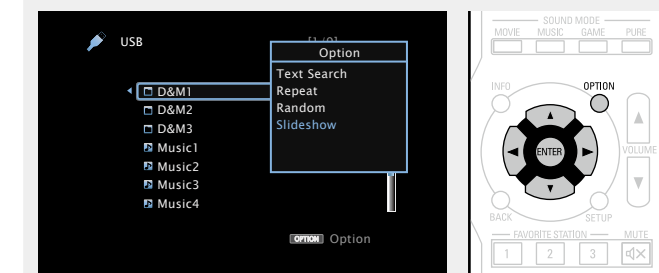

3 Use $\triangleleft \triangleright$ to set the display time.

• Each time $\triangleleft \triangleright$ is pressed, the setting is changed as shown below.

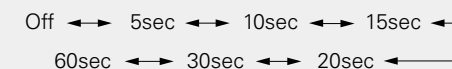

Off The slide show is not played back.

5sec – 60sec Set the time for displaying a single image when playing back images in the slide show.

4 Press **ENTER**.
The slide show is displayed on the screen.

5 Playback an image.



This unit plays back image (JPEG) files in the orientation in which they are stored in the folder.



AirPlay function

Enjoy music from your iTunes library with high quality sound anywhere in your home.

Use the Apple Remote app* for iPhone, iPod touch and iPad to control iTunes from any room in your home.

* Available as a free download from the App Store.

Streaming music stored in iPhone, iPod touch or iPad directly to the unit

If you update your "iPhone/iPod touch/iPad" to iOS 4.2.1 or later, you can stream music stored in your "iPhone/iPod touch/iPad" directly to this unit.

1 Make the Wi-Fi settings for iPhone, iPod touch, or iPad.

• For details, see your device's manual.

2 Startup iPhone, iPod touch, or iPad music or iPod app.

 is displayed on the iPhone, iPod touch or iPad screen.

3 Tap the AirPlay icon .

4 Select the speaker you want to use.

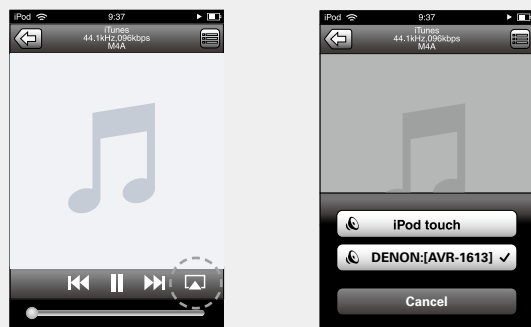

NOTE

In playback using the AirPlay function, the sound is output at the iPhone, iPod touch, iPad or iTunes volume setting level.

You should turn down the iPhone, iPod touch, iPad or iTunes volume prior to playback and then adjust it to a suitable level.

Playing iTunes music with this unit

1 Install iTunes 10, or later, on a Mac or Windows PC that is connected to the same network as this unit.

2 Turn this unit ON.

Set "IP Control" ([page 98](#)) to "Always On" for this unit.

NOTE

When "IP Control" is set to "Always On", the unit consumes more standby power.

3 Launch iTunes and click the AirPlay icon displayed in the lower right of the window and select this unit from the list.



4 Choose a song and click play in iTunes.

The music will stream to this unit.

Selecting multiple speakers (devices)

It is possible to play iTunes songs on your home's AirPlay compatible speakers (devices) other than those of this unit.

1 Click the AirPlay icon and select "Multiple Speakers" from the list.

2 Check the speakers you want to use.

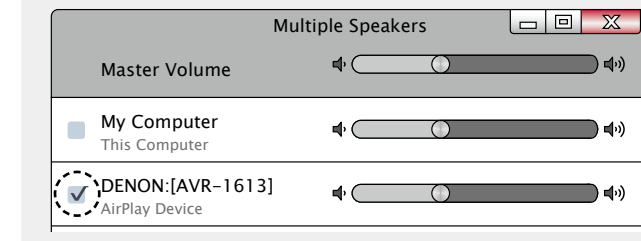

 See overleaf

□ Perform iTunes playback operations with the remote control unit of this unit

With this unit's remote control unit, you can perform iTunes song play, pause, and auto search (cue) operations.

1 Select “Edit” – “Preferences...” on the menu.

2 Select “Devices” in the iTunes setting window.

3 Check “Allow iTunes control from remote speakers”, and then click “OK”.

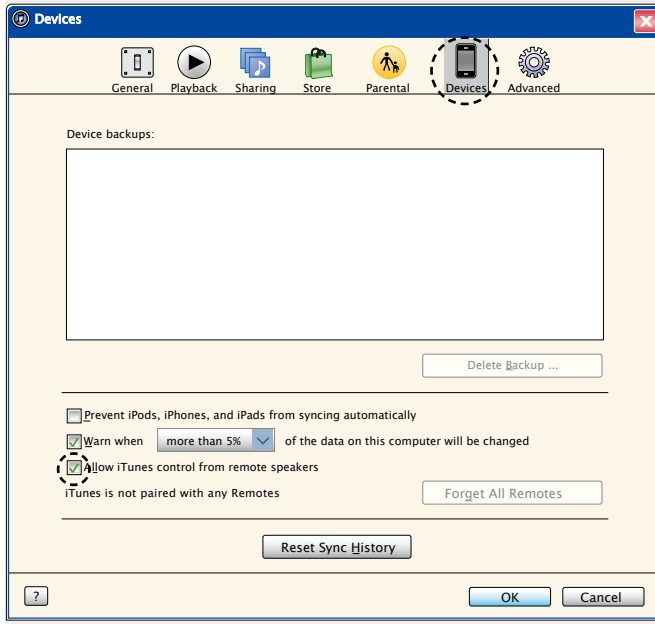

-  is displayed on the menu screen while AirPlay is being operated.
- Source input will be switched to “NETWORK” when AirPlay playback is started.
- You can stop AirPlay playback by pressing the ◀ or choosing other input source.
- To see song and artist names together, press **STATUS** on the main unit.
- For information about how to use iTunes, also see the Help for iTunes.
- The screen may differ depending on the OS and software versions.

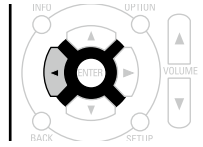

Selecting a listening mode (Sound Mode)

This unit allows you to enjoy various kinds of surround and stereo playbacks.

Multi-channel audio formats are adopted by many of the contents including Blu-ray disc and DVD as well as digital broadcasting and Internet-delivered movies and music.

This unit supports playback of almost all of these multi-channel audio formats. It also supports surround playback of audio formats other than multi-channel audio such as 2-channel stereo audio.

This unit automatically generates a list of all the playable sound modes based on the input audio format and the current speaker setup configuration and displays the list on the screen. Therefore, you can select a correct surround playback mode even if you are not familiar with sound mode selection. Try out various surround playback modes and enjoy surround playback in your favorite mode.

[Example] When **MOVIE** is pressed and held



This unit provides not only sound modes that conform to the formats recorded in discs such as Dolby and DTS but also “original listening modes” that create atmosphere of ROCK ARENA and JAZZ CLUB, etc.

The displayed sound modes include the 2-channel stereo playback mode.



For audio formats recorded in a disc, see the disc jacket.

Selecting a listening mode

1 Play the selected device ([page 28](#) – [32](#)).

2 Press and hold **MOVIE**, **MUSIC** or **GAME** to select a listening mode.

This unit automatically generates and displays a list of selectable sound modes.

- Each time **MOVIE**, **MUSIC** or **GAME** is pressed, the listening mode is switched.

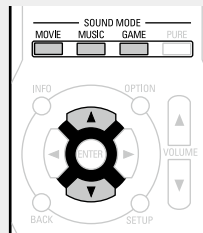

MOVIE
 Switches to the listening mode suitable for enjoying movies and TV programs.

MUSIC
 Switches to the listening mode suitable for enjoying music.

GAME
 Switches to the listening mode suitable for enjoying games.

- Pressing **MOVIE**, **MUSIC** or **GAME** displays a list of the listening modes that can be selected. Each time you press **MOVIE**, **MUSIC** or **GAME**, the listening mode changes.
- While the list is displayed, you can also use Δ / ∇ to select a listening mode.



- The **MOVIE**, **MUSIC**, or **GAME** button memorizes the last sound mode selected for its button. Pressing **MOVIE**, **MUSIC**, or **GAME** recalls the same sound mode as the one selected at the previous playback.
- If the content played back does not support the previously selected sound mode, the most standard sound mode for the content is automatically selected.

Direct playback

Sound recorded in source is played as is.

1 Play the selected device ([page 28](#) – [32](#)).

2 Press **PURE** to select “DIRECT”.
Direct playback begins.

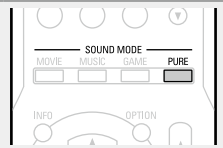

In Direct listening mode, the following items cannot be adjusted.

- Tone ([page 82](#))
- MultEQ® ([page 84](#))
- Dynamic EQ® ([page 84](#))
- Dynamic Volume® ([page 84](#))
- Restorer ([page 83](#))

Listening mode

- The following listening modes can be selected using the **MOVIE**, **MUSIC**, **GAME**, and **PURE** buttons.
- Adjust the sound field effect with the menu "Surr.Parameter" (page 81) to enjoy your favorite sound mode.

Operation button	Input signal	Listening mode	
MOVIE <input type="checkbox"/>	2-channel *1	STEREO	
		DOLBY PLII Cinema *2	
		DOLBY Pro Logic *2	
		DTS NEO:6 Cinema *2	
		MULTI CH STEREO	
		MONO MOVIE	
		VIRTUAL	
	Multi-channel *3	STEREO	
		Dolby Digital	DOLBY DIGITAL
		Dolby TrueHD	DOLBY TrueHD
		Dolby Digital Plus	DOLBY DIGITAL Plus
		DTS	DTS SURROUND
			DTS 96/24
		DTS-HD / DTS Express	DTS-HD HI RES
			DTS-HD MSTR
			DTS Express
		PCM multi-channel	MULTI CH IN
	MULTI CH STEREO		
	MONO MOVIE		
	VIRTUAL		

Operation button	Input signal	Listening mode	
MUSIC <input type="checkbox"/>	2-channel *1	STEREO	
		DOLBY PLII Music *2	
		DTS NEO:6 Music *2	
		MULTI CH STEREO	
		ROCK ARENA	
		JAZZ CLUB	
		MATRIX	
		VIRTUAL	
	Multi-channel *3	STEREO	
		Dolby Digital	DOLBY DIGITAL
		Dolby TrueHD	DOLBY TrueHD
		Dolby Digital Plus	DOLBY DIGITAL Plus
		DTS	DTS SURROUND
			DTS 96/24
		DTS-HD / DTS Express	DTS-HD HI RES
			DTS-HD MSTR
			DTS Express
		PCM multi-channel	MULTI CH IN
			MULTI CH STEREO
			ROCK ARENA
		JAZZ CLUB	
	MATRIX		
	VIRTUAL		

- *1 2-channel also includes analog input.
- *2 This mode plays back 2-channel source in 5.1-channel playback. It cannot be selected when headphones are used, or when only front speakers are used.
- *3 Some listening modes cannot be selected, depending on the audio format or number of channels of the input signal. For details, see "Types of input signals, and corresponding sound modes" (page 115).

 See overleaf



Operation button	Input signal	Listening mode	
GAME <input type="checkbox"/>	2-channel *1	STEREO	
		DOLBY PLII Game *2	
		MULTI CH STEREO	
		VIDEO GAME VIRTUAL	
	Multi-channel *3	STEREO	
		Dolby Digital	DOLBY DIGITAL
		Dolby TrueHD	DOLBY TrueHD
		Dolby Digital Plus	DOLBY DIGITAL Plus
		DTS	DTS SURROUND DTS 96/24
		DTS-HD / DTS Express	DTS-HD HI RES DTS-HD MSTR DTS Express
		PCM multi-channel	MULTI CH IN MULTI CH STEREO VIDEO GAME VIRTUAL
PURE <input type="checkbox"/>	All	DIRECT	

- *1 2-channel also includes analog input.
- *2 This mode plays back 2-channel source in 5.1-channel playback. It cannot be selected when headphones are used, or when only front speakers are used.
- *3 Some listening modes cannot be selected, depending on the audio format or number of channels of the input signal. For details, see "Types of input signals, and corresponding sound modes" ([page 115](#)).

Views on the TV screen or display

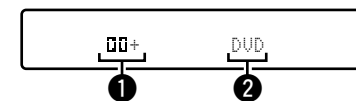

- ❶ Shows a decoder to be used.
 - A DOLBY DIGITAL Plus decoder is displayed as "Dolby Digital Plus".
- ❷ Shows the name of the input source being played back.



□ Description of listening mode types

Dolby listening mode

Listening mode type	Description
DOLBY PLII	This mode can be selected when a Dolby Pro Logic II decoder is used to play back 2-channel source in 5.1-channel surround sound with a natural, realistic feel.
DOLBY Pro Logic	This mode can be selected when a Dolby Pro Logic decoder is used to play 2-channel source in 4.1-channel surround sound (Left/Center/Right/Surround Mono).
DOLBY DIGITAL	This mode can be selected when playing sources recorded with Dolby Digital.
DOLBY TrueHD	This mode can be selected when playing sources recorded in Dolby TrueHD.
DOLBY DIGITAL Plus	This mode can be selected when playing sources recorded with Dolby Digital Plus.

DTS listening mode

Listening mode type	Description
DTS NEO:6	This mode can be selected when a DTS NEO:6 decoder is used to play back 2-channel source in 5.1-channel surround sound. There is a "Cinema" mode optimized for movie playback, and a "Music" mode optimized for music playback.
DTS SURROUND	This mode can be selected when playing sources recorded in DTS.
DTS 96/24	This mode can be selected when playing sources recorded in DTS 96/24.
DTS-HD	This mode can be selected when playing sources recorded in DTS-HD.
DTS Express	This mode can be selected when playing sources recorded in DTS Express.

PCM multi-channel listening mode

Listening mode type	Description
MULTI CH IN	This mode can be selected when playing multi-channel PCM sources .

Original listening mode

Listening mode type	Description
MULTI CH STEREO	This mode is for enjoying stereo sound from all speakers. The same sound as that from the front speakers (L/R) is played back at the same level from the surround speakers (L/R).
ROCK ARENA	This mode is for enjoying the atmosphere of a live concert in an arena.
JAZZ CLUB	This mode is for enjoying the atmosphere of a live concert in a jazz club.
MONO MOVIE	This mode is for playing monaural movie sources with surround sound. When playing sources recorded in monaural in the "MONO MOVIE" mode, the sound will be off balance with a single channel (left or right), so input to both channels.
VIDEO GAME	This mode is suited for achieving surround sound with video games.
MATRIX	This mode lets you add a spacious feel to stereo music sources.
VIRTUAL	This mode is for enjoying surround effects using only the front speakers or headphones.

STEREO listening mode

Listening mode type	Description
STEREO	This is the mode for playing in stereo. The tone can be adjusted. <ul style="list-style-type: none"> • Sound is output from the front left and right speakers and subwoofer. • If multichannel signals are input, they are mixed down to 2-channel audio and are played.

Direct listening mode

Listening mode type	Description
DIRECT	Sound recorded in source is played as is.

Advanced version

Here, we explain functions and operations that let you make better use of this unit.

- **Installation/connection of speakers (Advanced)**  [page 69](#)
- **Playback (Advanced operation)**  [page 73](#)
- **How to make detailed settings**  [page 76](#)

Installation/connection of speakers (Advanced)

Procedure for speaker settings

Speaker installation



Speaker connection (page 70)

Speaker installation

- Determine the speaker system depending on the number of speakers you are using and install each speaker and subwoofer in the room. Here, we explain how to install the speakers using a typical example.
- The speaker impedance should be from 6 to 16 Ω.



Use the illustration below as a guide for how high each speaker should be installed. The height does not need to be exactly the same.

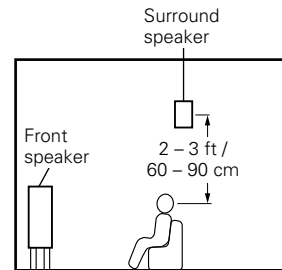

[Viewed from the side]

When 5.1ch speakers are installed

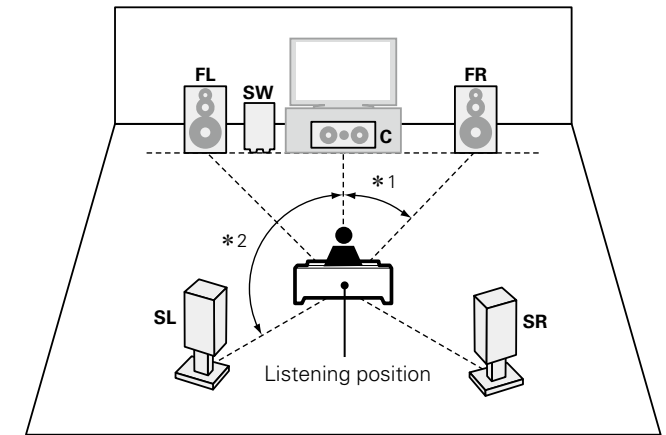

*1 22° - 30° *2 120°

[Speaker abbreviations]

FL	Front speaker (L)	SW	Subwoofer
FR	Front speaker (R)	SL	Surround speaker (L)
C	Center speaker	SR	Surround speaker (R)

Speaker connection

Here, we connect the speakers in the room to this unit.
This section explains how to connect them using a typical example.

- ❑ **Connecting 5.1-channel speakers** (👉 page 71)
- ❑ **Connecting 2.1-channel speakers** (👉 page 72)

NOTE

- **Disconnect this unit's power plug from the power outlet before connecting the speakers. Also, turn off the subwoofer.**
- **Connect so that the speaker cable core wires do not protrude from the speaker terminal. The protection circuit may be activated if the core wires touch the rear panel or if the + and – sides touch each other** (👉 page 118 "Protection circuit").
- **Never touch the speaker terminals while the power supply is connected. Doing so could result in electric shock. When the "Setup Assistant" is running, follow the instructions in the "Setup Assistant" screen for making connections. (Power is not supplied to the speaker terminals while the "Setup Assistant" is running.)**
- **Use speakers with the speaker impedances shown below.**

Speaker terminals	Speaker impedance
FRONT	6 – 16 Ω
CENTER	
SURROUND	

Connecting the speaker cables

Carefully check the left (L) and right (R) channels and + (red) and – (black) polarities on the speakers being connected to this unit, and be sure to interconnect the channels and polarities correctly.

1 Peel off about 0.03 ft/10 mm of sheathing from the tip of the speaker cable, then either twist the core wire tightly or terminate it.



2 Turn the speaker terminal counterclockwise to loosen it.

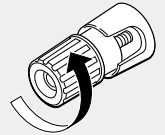

3 Insert the speaker cable's core wire to the hilt into the speaker terminal.

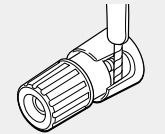

4 Turn the speaker terminal clockwise to tighten it.

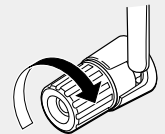

Connecting the subwoofer

Use a subwoofer cable to connect the subwoofer.

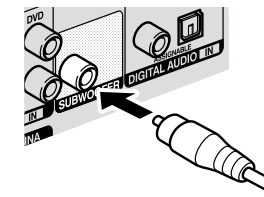

Connecting 5.1-channel speakers

Cables used for connections

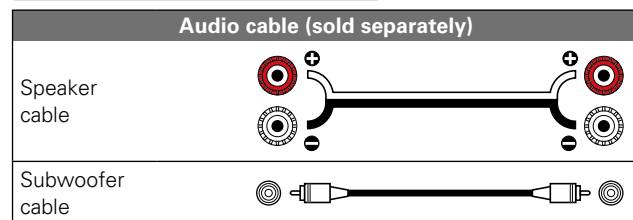

NOTE

- For speaker cable connections, see [page 70](#).
- For speaker impedance, see [page 70](#).

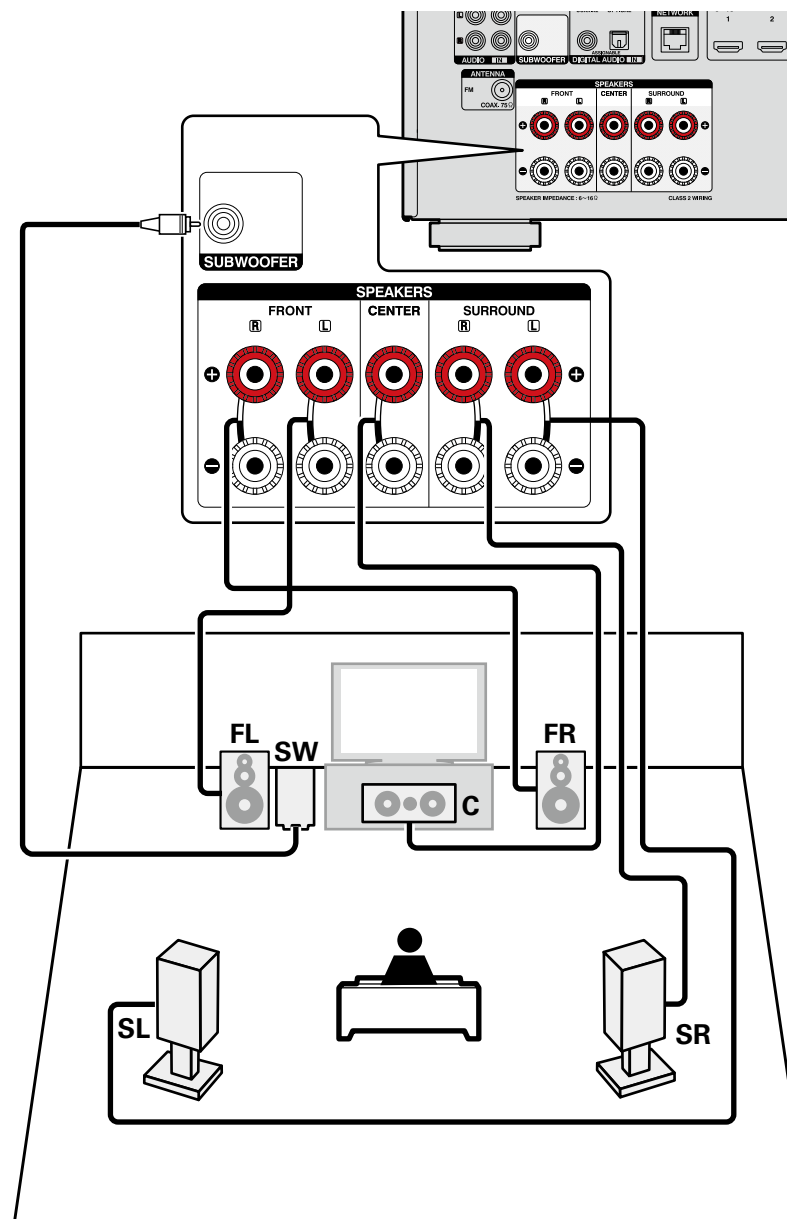

Connecting 2.1-channel speakers

Cables used for connections

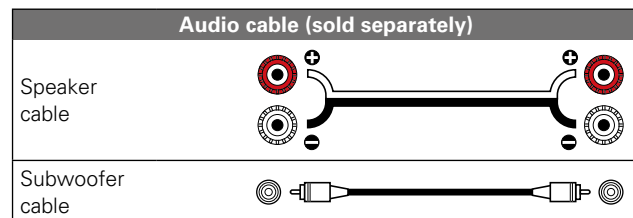

NOTE

- For speaker cable connections, see [page 70](#).
- For speaker impedance, see [page 70](#).

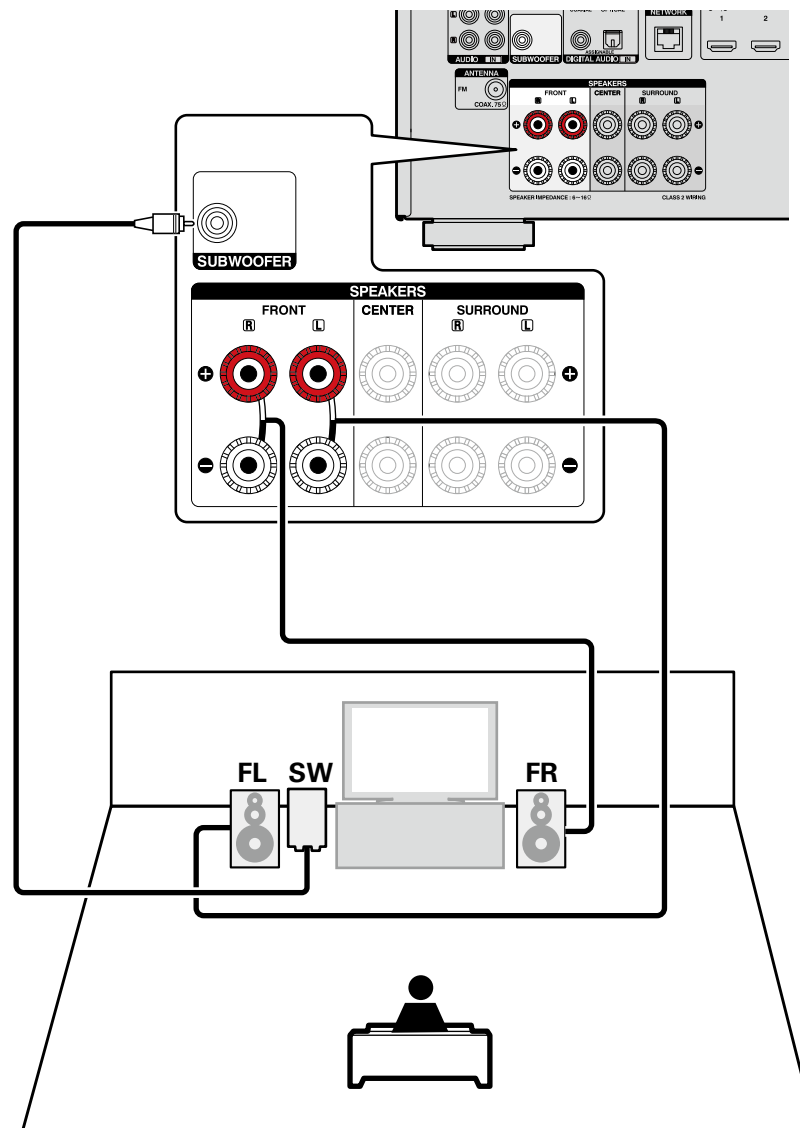

Basic version

Advanced version

Information



Settings (👉 page 20)

Playback (Basic operation) (👉 page 27)

Selecting a listening mode (Sound Mode)
(👉 page 64)

❑ HDMI control function (👉 page 73)

❑ Sleep timer function (👉 page 74)

❑ Quick select function (👉 page 75)

❑ Various memory functions (👉 page 75)

HDMI control function

If you connect the unit and an HDMI control function compatible TV or player with an HDMI cable and then enable the HDMI control function setting on each device, the devices will be able to control each other.

❑ Operations possible by HDMI control

- **This unit power off can be linked to the TV power off step.**
- **You can switch audio output devices with a TV operation.**
When you set "Output audio from amp" in the TV audio output setup operation, you can switch the amp power on.
- **You can adjust this unit volume in the TV volume adjustment operation.**
- **You can switch this unit input sources through linkage to TV input switching.**
- **When playing the player, this unit input source switches to the source for that player.**
- **If you switch the input source of the unit to "TV AUDIO", you can play TV audio with this unit (👉 page 8 "About ARC (Audio Return Channel) function").**
- **When "HDMI Control" (👉 page 87) in the menu is set to "On", signals input to the HDMI input connector are output to the television or other device connected to the HDMI output connector, even if the power of this unit is in standby (pass-through function).**



- To use this unit to play the audio of a TV that does not support the ARC function, connect the TV with an optical-digital or analog connection (👉 page 8).
- To use the pass-through function, connect an HDMI connection device that is compatible with HDMI control.

❑ Setting procedure

- 1 Set the HDMI output connector corresponding with the HDMI control function.**
Set "HDMI Control" (👉 page 87) to "On".
- 2 Turn the power on for all the devices connected by HDMI cable.**
- 3 Set the HDMI control function for all devices connected by HDMI cable.**
 - Please consult the operating instructions for the connected devices to check the settings.
 - Carry out steps 2 and 3 should any of the devices be unplugged.
- 4 Switch the television input to the HDMI input connected to this unit.**
- 5 Switch this unit input to the HDMI input source and check if the picture from the player is ok.**
- 6 When you turn the TV's power to standby, check that the power of this unit also goes to standby.**



If the HDMI control function does not operate properly, check the following points.

- Is the TV or player compatible with the HDMI control function?
- Is "HDMI Control" (👉 page 87) set to "On"?
- Is "P.Off Control" (👉 page 87) set to "All" or "Video"?
- Are the HDMI control function settings of all devices correct?

👉 See overleaf

NOTE

- When “HDMI Control” is set to “On”, it consumes more standby power.
- The HDMI control function controls operations of a TV that is compatible with the HDMI control function. Make sure that the TV and HDMI are connected when you perform HDMI control.
- Some functions may not operate depending on the connected TV or player. Check the owner’s manual of each device for details beforehand.
- When “P.Off Control” on the menu is set to “Off” (page 87), this unit is not set to standby even if the connected device is in the standby mode.
- When connection changes are implemented, such as adding connections to HDMI devices, linked operations may be initialized. In this case, you will need to reconfigure the settings.
- Should any of the operations below be performed, the interlocking function may be reset, in which case, repeat steps 2 and 3.
 - There is a change to the connection between the devices and the HDMI, or an increase in devices.

Sleep timer function

You can have the power automatically switched to standby once a set time has elapsed. This is convenient for viewing and listening while going to sleep.

Press SLEEP and display the time you want to set.

The **SLEEP** indicator on the display lights.

- The time switches as shown below each time **SLEEP** is pressed.

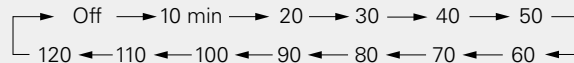
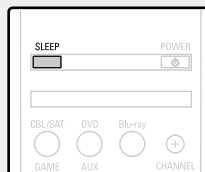
**To confirm the countdown time before putting the unit to sleep**

Press **SLEEP**.

“Sleep : *min” appears on the display.

* Countdown time

To cancel the sleep timer

Press **SLEEP** to set “Off”.

The **SLEEP** indicator on the display turns off.



The sleep timer setting is canceled if this unit’s power is set to standby.

NOTE

The sleep timer function cannot turn off the power of devices connected to this unit. To turn off the power of those connected devices, set up sleep timers on the connected devices themselves.

Quick select function

You can save settings such as the input source selection, volume level, and sound mode at the **QUICK SELECT 1 – 4** buttons.

You can simply press one of the set **QUICK SELECT** buttons for subsequent playback to switch to various saved settings all at once.

- By saving frequently used settings at the **QUICK SELECT 1 – 4** buttons, you will always be able to easily call up the same playback environment.

Press QUICK SELECT.

The Quick Select settings for the button you pressed are called up.

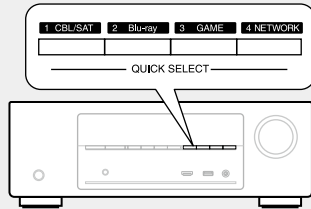

- The default settings of each QUICK SELECT are as shown below.

Button	Input source	Volume	Sound Mode
QUICK SELECT 1	CBL/SAT	40	STEREO
QUICK SELECT 2	Blu-ray	40	STEREO
QUICK SELECT 3	GAME	40	STEREO
QUICK SELECT 4	NETWORK	40	STEREO

Changing the Quick Select Name

On this unit, you can change the Quick Select name displayed on the menu to the name that you prefer.

For the name change method, see “Quick Sel.Names” ([page 102](#)).

Changing the settings

1 Set the items below to the settings you want to save.

- ① Input source* ([page 27](#))
- ② Volume ([page 28](#))
- ③ Sound Mode ([page 64](#))
- ④ Audyssey
(Audyssey MultEQ®, Audyssey Dynamic EQ®, Audyssey Dynamic Volume®) ([page 84](#))

2 Press and hold the desired QUICK SELECT until “Quick* Memory” appears on the display.

The current settings will be memorized.

- * The number for the **QUICK SELECT** button you pressed is displayed.

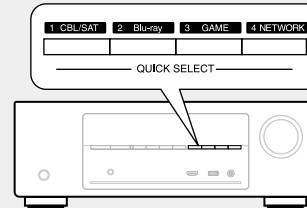

Various memory functions

Personal memory plus function

This function sets the settings (input mode, sound mode, HDMI output mode, MultEQ®, Dynamic EQ®, audio delay etc.) last selected for the individual input sources.



The surround parameters, tone settings and the volumes of the different speakers are stored for the individual sound modes.

Last function memory

This function stores the settings which were made before going into the standby mode.



When the power is turned back on, the settings are restored.





How to make detailed settings

Menu map

For menu operation, connect a TV to this unit and display the menu on the TV screen. For menu operations, see the following page.

By default, this unit has recommended settings defined. You can customize this unit based on your existing system and your preferences.

Setting items	Detailed items	Description	Page
 Audio	Surr.Parameter	Adjusts surround sound parameters.	81
	Tone	Adjusts the tonal quality of the sound.	82
	Dialogue Level	Sets the output level to clarify the dialogue output from the center channel.	82
	Subwoofer Level	Sets the subwoofer on/off and its output level.	83
	Restorer	Expands the low and high frequency components of compressed audio to enable richer audio playback.	83
	Audio Delay	Compensates for incorrect timing between video and audio.	83
	Volume	Set the volume setting.	83
	Audyssey	Makes Audyssey MultEQ®, Audyssey Dynamic EQ® and Audyssey Dynamic Volume® settings.	84
	Manual EQ	Uses the graphic equalizer to adjust the tone of each speaker.	85
 Video	HDMI Setup	Makes settings for HDMI video/audio output.	87
	Volume Display	Sets where to display the master volume level.	87
	Info.Display	Displays status of operation temporarily when the sound mode is changed or input source is switched. You can set whether or not to show each of these status displays.	88
	Audio Display	Sets how long each menu is displayed when the input source is "NETWORK", "iPod/USB", or "FM".	88
	TV Format	Set the video signal format to be output for the TV you are using.	88
 Inputs	Digital Assign	Changes input connector assignment.	90
	Source Rename	Changes the display name for this source.	91
	Hide Source	Remove from the display input sources that are not used.	91
	Source Level	Adjusts the playback level of the audio input.	91
	Input Select	Sets the audio input mode and decode mode.	91
	Video Source	Video of another input source is played back combined with the playing audio.	92

Setting items	Detailed items	Description	Page
 Speakers	Audyssey® Setup	The acoustic characteristics of the connected speakers and listening room are measured and the optimum settings are made automatically.	20
	Manual Setup	Perform when setting the speakers manually or when changing settings made in Audyssey® Setup.	94
 Network	Information	Display network information.	98
	IP Control	Set the network function on/off during standby.	98
	Friendly Name	The Friendly Name is the name of this unit displayed on the network. You can change the Friendly Name according to your preferences.	98
	Settings	Make settings for wired LAN.	99
 General	Language	Sets the language for display the menu on the TV screen.	102
	Quick Sel.Names	Change the "Quick Select" display title to one you prefer.	102
	Auto Standby	When you do not perform any operation on this unit with no audio or video input for a specified time, this unit automatically enters the standby mode. Before it enters the standby mode, "Auto Standby" is displayed on the display of this unit and the menu screen.	102
	Front Display	Adjust the display brightness of this unit.	102
	Information	Show information about receiver settings, input signals, etc.	103
	Firmware	Set whether or not to check for firmware update, update the firmware, and display update and upgrade notifications.	104
	Setup Lock	Protect settings from inadvertent change.	105
	Setup Assistant	Perform the installation, connection, and setup procedures to prepare the unit for operation following guidance.	 7

Examples of menu screen displays

Typical examples are described below.

[Example 1]

Menu selection screen (Top menu)

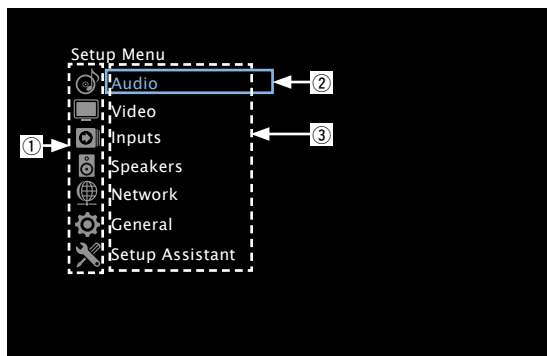

- ① List of GUI menu setup icons
- ② Currently selected setup item
- ③ List of GUI menu setup items

Press Δ / ∇ to select "Audio" and then press \triangleright . (Or press ENTER.)

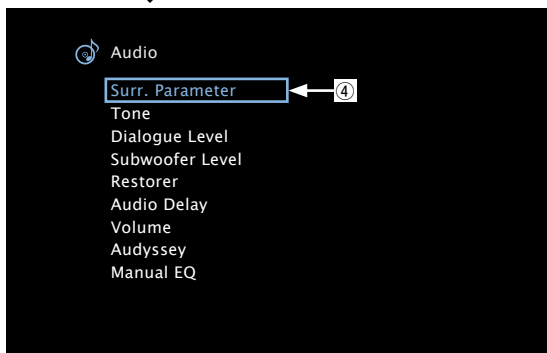

- ④ Selected setup item

[Example 2]

Audyssey® Setup screen (with illustration)

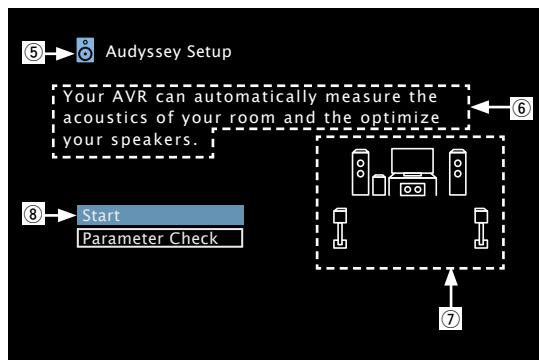

- ⑤ History icon
- ⑥ Operation guidance text
- ⑦ Illustration
- ⑧ Selected setup item

NOTE

When the menu is operated on a computer's resolution (e.g. VGA) or during playback of certain 3D video content, the playback image switches to the menu screen image.

List

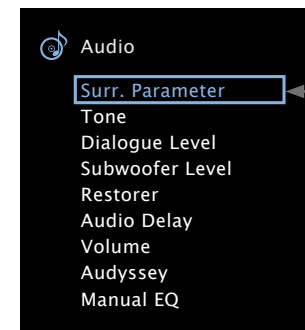

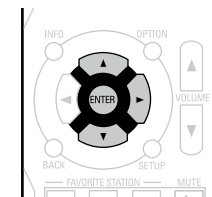

Selected item

- Switch the selected item using Δ / ∇ .

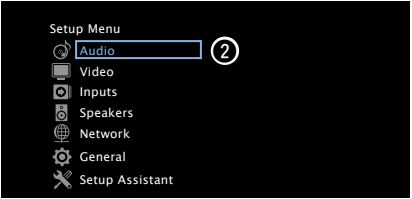

Examples of menu and front display

Below we describe typical examples of displays on the TV screen and on the set's display window.

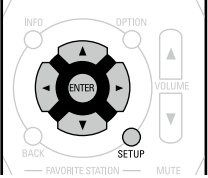
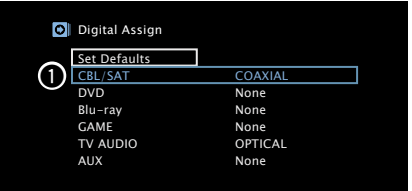
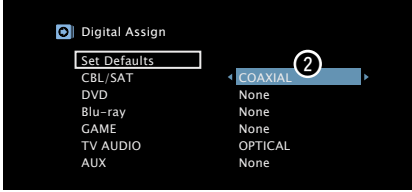
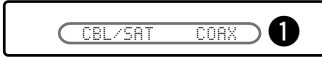
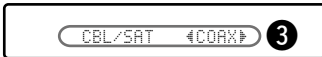
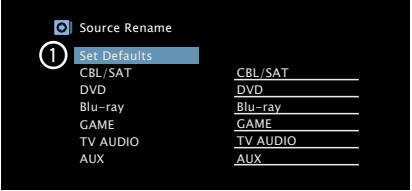
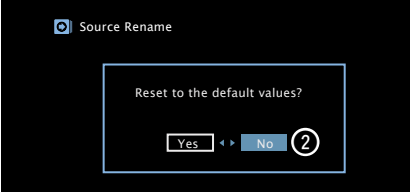
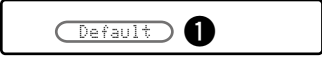
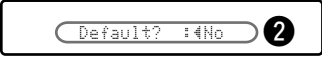
	Menu display	Front display	Description
Top menu display			<ol style="list-style-type: none"> Press SETUP to display the menu screen. TV screen: Displays the selected line. Display: Displays the selected item. <ul style="list-style-type: none"> Use Δ/∇ to move to the item you want to set. 
Display when changing settings	 <p style="text-align: center;">↓ Press ENTER.</p> 	 <p style="text-align: center;">↓ Press ENTER.</p> 	<ol style="list-style-type: none"> TV screen: Displays the selected line. Display: Displays the selected item. Press ENTER to set to the mode in which the setting can be made. <p>3 ◀▶ is displayed at the sides of items whose setting can be changed. Use ◀▶ to change to the desired setting.</p>
Display when returning to the settings in effect at time of purchase	 <p style="text-align: center;">↓ Press ENTER.</p> 	 <p style="text-align: center;">↓ Press ENTER.</p> 	<ol style="list-style-type: none"> Press Δ to select "Set Defaults", then press ENTER. Press \triangleleft to select "Yes", then press ENTER.



Inputting characters

On this unit, you can change the name displayed on the following screens to the names that you prefer.

- Text Search (☞ page 58)
- Preset Name (☞ page 40)
- Source Rename (☞ page 91)
- Friendly Name (☞ page 98)
- Quick Sel.Names (☞ page 102)
- Character input for the network functions (☞ page 43, 51, 53, 56, 100)

Keyboard screen

Select a character on the TV screen to input characters.

□ Display of a keyboard input screen

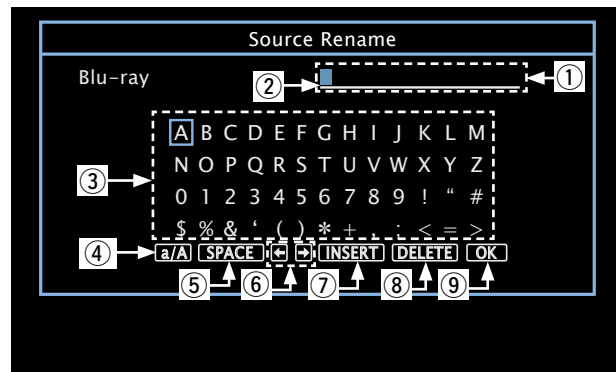

- ① Character input section
- ② Cursor
- ③ Keyboard section
- ④ Uppercase and lowercase switch key
- ⑤ Space key
- ⑥ Cursor keys
- ⑦ Insert key
- ⑧ Delete key
- ⑨ OK key

□ Input method

1 Display the screen for inputting characters (☞ page 76 “Menu map”).

2 Select a character to be changed.
① Use $\Delta \nabla \triangleleft \triangleright$ to select \leftarrow or \rightarrow .

② Press **ENTER** to place the cursor at the character to be changed.

Each time **ENTER** is pressed, the cursor moves by one character.

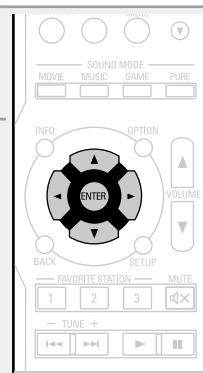

3 Select a character to be input with $\Delta \nabla \triangleleft \triangleright$ then press **ENTER**.

- The types of characters that can be input are as shown below.

[Upper case characters/Numbers/Symbols]

ABCDEFGHIJKLMNOPQRSTUVWXYZ

0123456789

! " # \$ % & ' () * + , ; < = >

[Lower case characters/Numbers/Symbols]

abcdefghijklmnopqrstuvwxyz

0123456789

. @ _ / : ; ~ ? [\] ^ ' { | }

- When you use $\Delta \nabla$ while you type in, you can change uppercase characters to lowercase and vice versa.

4 Repeat steps 2 and 3 to change the name.

5 Use $\Delta \nabla \triangleleft \triangleright$ to select **OK**, then press **ENTER**.



Make audio-related settings.

Menu operation

- 1 Press SETUP.**
The menu is displayed on the TV screen.
- 2 Use Δ / ∇ to select the menu to be set or operated.**
- 3 Press ENTER or \triangleright to enter the setting.**
 - To return to the previous item, press \triangleleft or **BACK**.
 - Exiting the Menu, press **SETUP** while the menu is displayed.
The menu display disappears.

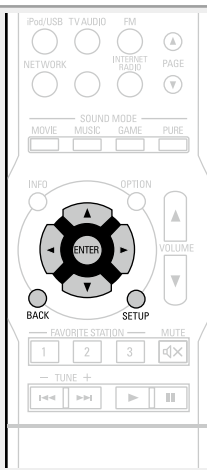

Items that can be set with the "Audio" procedure

Surr.Parameter (👉 page 81)

Tone (👉 page 82)

Dialogue Level (👉 page 82)

Subwoofer Level (👉 page 83)

Restorer (👉 page 83)

Audio Delay (👉 page 83)

Volume (👉 page 83)

Audyssey (👉 page 84)

Manual EQ (👉 page 85)



Surr.Parameter



Default settings are underlined.

You can adjust the surround audio sound field effects to match your preferences. The items (parameters) that can be adjusted depend on the signal being input and the currently set sound mode. For details on the adjustable parameters, see “Sound modes and surround parameters” ([page 113](#)).

NOTE

Some setting items cannot be set while playback is stopped. Make the settings during playback.

Setting items	Setting details
Cinema EQ Soften the treble range of movie soundtracks for better understanding.	On : “Cinema EQ” is used. Off : “Cinema EQ” is not used.
Loudness Mngmt This can be set in the Dolby TrueHD mode. This sets whether to output as specified in “Dynamic Comp.” or output directly without compressing the dynamic range of audio recorded in the disc.	On : Outputs using the settings made in “Dynamic Comp.”. Off : “Dynamic Comp.” settings and “Dialogue normalization” (page 103) are disabled, and the signals on the disk are output as is.
Dynamic Comp. Compress dynamic range (difference between loud and soft sounds).	Auto : Automatic dynamic range compression on/off control according to source. Low / Medium / High : These set the compression level. Off : Dynamic range compression always off.  You can set “Auto” only for the Dolby TrueHD source.
Low Frequency Adjust the low-frequency effects level (LFE).	-10dB – 0dB  For proper playback of the different sources, we recommend setting to the values below. <ul style="list-style-type: none"> • Dolby Digital sources : “0dB” • DTS movie sources : “0dB” • DTS music sources : “-10dB”

Setting items	Setting details
Center Image Distributes the dialogue output from the center channel to the front left and right channels and widens the sound image in the front. You can set this when the sound mode is set to DTS NEO:6 in the “Music” mode.	0.0 – 1.0 (0.3)  The smaller the value, the more dialogue is concentrated on the center channel. The larger the value, the more dialogue is distributed to front left and right channels, and the more the sound image widens in the front.
Panorama Assign front L/R signal also to surround channels for wider sound. You can set this when the sound mode is Dolby PLII in the “Music” mode.	On : Set. Off : Do not set.
Dimension Shift sound image center to front or rear to adjust playback balance. You can set this when the sound mode is Dolby PLII in the “Music” mode.	0 – 6 (3)  As you set a smaller number, the surround sound field shifts backward; as you set a larger number, the surround sound field shifts forward.
Center Width Distributes the dialogue output from the center channel to left and right channels and widens the sound image in the front. You can set this when the sound mode is Dolby PLII in the “Music” mode.	0 – 7 (3)  The smaller the value, the more dialogue is concentrated on the center channel. The larger the value, the more dialogue is distributed to front left and right channels, and the more the sound image widens in the front.

 See overleaf



Setting items	Setting details
Delay Time Adjust the audio delay time against video to extend the sound field image. You can set this when the sound mode is "MATRIX".	0ms – 300ms (30ms)
Effect Level Adjust the sound effect level. You can set this when the sound mode is original listening mode.	1 – 15 (10) Set to a lower level if the positioning and sense of phase of the surround signals seems unnatural.
Room Size Determine size of acoustic environment. You can set this when the sound mode is original listening mode.	Small : Simulate acoustics of a small room. Medium small : Simulate acoustics of a medium-small room. Medium : Simulate acoustics of a medium room. Medium large : Simulate acoustics of a medium-large room. Large : Simulate acoustics of a large room. <p>NOTE</p> "Room Size" does not indicate the size of the room in which sources are played.
Set Defaults The "Surr.Parameter" settings are returned to the default settings.	Yes : Reset to the defaults. No : Do not reset to the defaults. When you select "Set Defaults" and press ENTER , the "Reset to the default values?" prompt is displayed. Select either "Yes" or "No", and press ENTER .

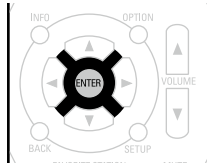

Tone

Default settings are underlined.

Adjust the tonal quality of the sound.

Setting items	Setting details
Tone Control Set the tone control function to "On" and "Off".	On : Allow tone adjustment (bass, treble). Off : Playback without tone adjustment. "Tone Control" can be set when "Dynamic EQ [®] " (page 84) is set to "Off". <p>NOTE</p> The tone cannot be adjusted in the "DIRECT" mode.
Bass Adjust bass.	-6dB – +6dB (0dB) "Bass" can be set when the menu "Tone Control" setting is "On".
Treble Adjust treble.	-6dB – +6dB (0dB) "Treble" can be set when the menu "Tone Control" setting is "On".

Dialogue Level

Default settings are underlined.

Sets the output level to clarify the dialogue output from the center channel.

Setting items	Setting details
Dialogue	-12dB – +12dB (0dB)

Subwoofer Level

Default settings are underlined.

Sets the subwoofer on/off and its output level.

Setting items	Setting details
Subwoofer Turn subwoofer output on and off.	On : The subwoofer is used. Off : The subwoofer is not used. <div style="background-color: #e91e63; color: white; padding: 2px; display: inline-block; border-radius: 5px;">NOTE</div> This can be set when the sound mode is "DIRECT" (page 64) and the "Subwoofer Mode" (page 94) is "LFE+Main".
Subwoofer Level Set the subwoofer output level.	-12dB – +12dB (0dB)

Restorer

Compressed audio formats such as MP3, WMA (Windows Media Audio) and MPEG-4 AAC reduce the amount of data by eliminating signal components that are hard for the human ear to hear. The "Restorer" function generates the signals eliminated upon compression, restoring the sound to conditions near those of the original sound before compression. It also corrects the sense of volume of the bass to obtain richer sound with compressed audio signals.

Setting items	Setting details
Restorer Set the mode for "Restorer".	Off : Do not use "Restorer". Mode1 (High) : Optimized mode for compressed sources with very weak highs (64 kbps and under). Mode2 (Middle) : Apply suitable bass and treble boost for all compressed sources (96 kbps and under). Mode3 (Low) : Optimized mode for compressed sources with normal highs (96 kbps and over). <div style="background-color: #e91e63; color: white; padding: 2px; display: inline-block; border-radius: 5px;">NOTE</div> <ul style="list-style-type: none"> This item can be set with analog signals or PCM signal (Sample rate = 44.1/48 kHz) is input. "Restorer" settings are stored for each input source. This item default setting for "NETWORK" and "iPod/USB" is "Mode3 (Low)". All others are set to "Off". This cannot be set when the sound mode is set to "DIRECT".

Audio Delay

Default settings are underlined.

While viewing video, manually adjust the time to delay audio output.

Setting details
0ms – 200ms <div style="background-color: #e91e63; color: white; padding: 2px; display: inline-block; border-radius: 5px;">NOTE</div> <ul style="list-style-type: none"> This item can be set within the range of 0 to 100 ms when "Auto Lip Sync" (page 87) is set to "On" and when a TV compatible with Auto Lip Sync is connected. Store "Audio Delay" for each input source.

Volume

Default settings are underlined.

Set the volume setting.

Setting items	Setting details
Scale Set how volume is displayed.	0 – 98 : Display in the range 0.5 (Min) to 98. -79.5dB – 18.0dB : Display -dB (Min), in the range -79.5 dB to 18.0 dB. <div style="background-color: #e91e63; color: white; padding: 2px; display: inline-block; border-radius: 5px;">NOTE</div> The "Scale" setting is applied also to the "Limit" and "Power On Level" display method.
Limit Make a setting for maximum volume.	Off : Do not set a maximum volume. 60 (-20dB) / 70 (-10dB) / 80 (0dB)
Power On Level Define the volume setting that is active when the power is turned on.	Last : Use the memorized setting from the last session. Mute : Always use the muting on condition when power is turned on. 1 – 98 (-79dB – 18dB) : The volume is adjusted to the set level.
Mute Level Set the amount of attenuation when muting is on.	Full : The sound is muted entirely. -40dB : The sound is attenuated by 40 dB down. -20dB : The sound is attenuated by 20 dB down.

Audyssey

Default settings are underlined.

Set Audyssey MultEQ®, Audyssey Dynamic EQ® and Audyssey Dynamic Volume®. These can be selected after Audyssey® Setup has been performed. For additional information on Audyssey technology, please see [page 117](#).



NOTE

- If you have not performed Auto Setup, or if you change the speaker settings after performing Auto Setup, you may not be able to select Dynamic EQ®/Dynamic Volume®. In this case, either perform Audyssey® Setup over again or perform “Restore...” ([page 26](#)) to return to the settings after Audyssey® Setup was run.
- When HD Audio for which the sampling frequency exceeds 96 kHz is played back, the “Audyssey” cannot be set.

Setting items	Setting details
MultEQ® MultEQ® compensates for both time and frequency characteristics of the listening area based on Audyssey® Setup measurement results. Selection is done from three types of compensation curves. We recommend the “Audyssey” setting. MultEQ® is the prerequisite function for Dynamic EQ® and Dynamic Volume®.	<p>Audyssey : Optimize the frequency response of all speakers.</p> <p>Audyssey Byp.L/R : Optimize frequency response of speakers except front L and R speakers.</p> <p>Audyssey Flat : Optimize frequency response of all speakers to flat response.</p> <p>Manual EQ : Apply frequency response set with “Manual EQ” (page 85).</p> <p>Off : Turn “MultEQ®” equalizer off.</p> <p></p> <ul style="list-style-type: none"> • “Audyssey”, “Audyssey Byp. L/R” and “Audyssey Flat” can be selected after Audyssey® Setup has been performed. “Audyssey” is automatically selected after performing Audyssey® Setup. When “Audyssey”, “Audyssey Byp. L/R” or “Audyssey Flat” is selected, AUDYSSEY illuminates. • After running Audyssey® Setup, if the Speaker Configuration, Distance, Channel Level, and Crossover Frequency have changed without increasing the number of speakers measured, only AUDYSSEY illuminates. <p>NOTE</p> <p>When using headphones, “MultEQ®” is automatically set to “Off”.</p>



“MultEQ®”, “Dynamic EQ®” and “Dynamic Volume®” settings are stored for each input source.

Setting items	Setting details
Dynamic EQ® Solve the problem of deteriorating sound quality as volume is decreased by taking into account human perception and room acoustics. Works with MultEQ®.	<p>On : Use Dynamic EQ®.</p> <p>Off : Do not use Dynamic EQ®.</p> <p></p> <p>AUDYSSEY is displayed when set to “On”.</p> <p>NOTE</p> <p>When the menu “Dynamic EQ®” setting is “On”, it is not possible to do “Tone Control” (page 82) adjustment.</p>
Reference Offset Audyssey Dynamic EQ® is referenced to the standard film mix level. It makes adjustments to maintain the reference response and surround envelopment when the volume is turned down from 0 dB. However, film reference level is not always used in music or other non-film content. Dynamic EQ® Reference Level Offset provides three offsets from the film level reference (5 dB, 10 dB, and 15 dB) that can be selected when the mix level of the content is not within the standard. Recommended setting levels are shown at right.	<p>0dB (Film Ref) : This is the default setting and should be used when listening to movies.</p> <p>5dB : Select this setting for content that has a very wide dynamic range, such as classical music.</p> <p>10dB : Select this setting for jazz or other music that has a wider dynamic range. This setting should also be selected for TV content as that is usually mixed at 10 dB below film reference.</p> <p>15dB : Select this setting for pop/rock music or other program material that is mixed at very high listening levels and has a compressed dynamic range.</p> <p> Setting is enabled when “Dynamic EQ®” is “On” (page 84).</p>
Dynamic Volume® Solve the problem of large variations in volume level between TV, movies and other content (between quiet passages and loud passages, etc.) by automatically adjusting to the user’s preferred volume setting.	<p>Heavy : Most adjustment to softest and loudest sounds.</p> <p>Medium : Medium adjustment to loudest and softest sound.</p> <p>Light : Least adjustment to loudest and softest sounds.</p> <p>Off : Do not use “Dynamic Volume®”.</p> <p></p> <ul style="list-style-type: none"> • AUDYSSEY is displayed when set to “Heavy”, “Medium” or “Light”. • If “Dynamic Volume®” is set to “Yes” in “Audyssey® Setup” (page 24), the setting is automatically changed to “Medium”.





Manual EQ

Default settings are underlined.

Use the graphic equalizer to adjust the tone of each speaker.

“Manual EQ” can be set when “MultEQ®” setting ([page 84](#)) is “Manual EQ”.

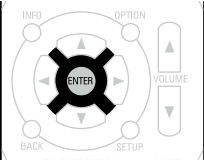
Setting items	Setting details
Speaker Select Select whether to adjust tones for individual speakers or for all speakers.	All : Adjust the tone of all speakers together. Left/Right : Adjust the tone of left and right speakers together. Each : Adjust the tone of each speaker.
Adjust EQ Adjust tones for each frequency band. Adjust the speaker selected in “Speaker Select”.	① Select the speaker. ② Select the adjustment frequency band. 63Hz / 125Hz / 250Hz / 500Hz / 1kHz / 2kHz / 4kHz / 8kHz / 16kHz • Select the speakers you want to adjust when “Left/Right” or “Each” is selected. ③ Adjust the level. -20.0dB – +6.0dB (0.0dB)
Curve Copy Copy “Audyssey Flat” (page 84) curve from MultEQ®.	Yes : Copy. No : Do not copy.  <ul style="list-style-type: none"> • “Curve Copy” is displayed after Audyssey® Setup has been performed. • When you select “Curve Copy” and press ENTER, the “Copy “Audyssey Flat?”” prompt is displayed. Select either “Yes” or “No”, and press ENTER.
Set Defaults The “Manual EQ” settings are returned to the default settings.	Yes : Reset to the defaults. No : Do not reset to the defaults.  When you select “Set Defaults” and press ENTER , the “Reset to the default values?” prompt is displayed. Select either “Yes” or “No”, and press ENTER . 



Make video-related settings.

Menu operation

1 Press **SETUP**.

The menu is displayed on the TV screen.

2 Use Δ / ∇ to select the menu to be set or operated.

3 Press **ENTER** or \triangleright to enter the setting.

- To return to the previous item, press \triangleleft or **BACK**.
- Exiting the Menu, press **SETUP** while the menu is displayed. The menu display disappears.

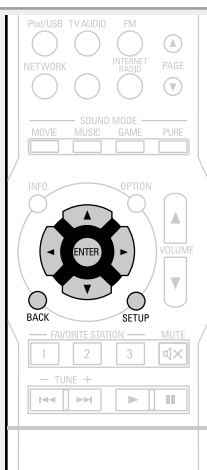

Items that can be set with the “Video” procedure

HDMI Setup (👉 page 87)

Volume Display (👉 page 87)

Info.Display (👉 page 88)



Audio Display (👉 page 88)



TV Format (👉 page 88)

HDMI Setup

Default settings are underlined.

Make settings for HDMI video/audio output.

Setting items	Setting details
Auto Lip Sync Make automatic compensation for timing shift in audio and video output.	On : Compensated. Off : Not compensated.
HDMI Audio Out Select HDMI audio output device.	AVR : Play back through speakers connected to the unit. TV : Play back through TV connected to the unit.  <ul style="list-style-type: none"> The audio signal input from the HDMI input connector can be output as an output signal from the HDMI output connector by setting the HDMI audio output destination to TV. Audio signals input via the Analog/Coaxial/Optical input connectors cannot be output from the HDMI output connector. When the HDMI control function is activated, priority is given to the TV audio setting (page 73 "HDMI control function").
HDMI Control You can link operations with devices connected to HDMI and compatible with HDMI Control.	On : Use HDMI control function. Off : Do not use HDMI control function.  <ul style="list-style-type: none"> When a device that is not compatible with the HDMI control function is connected, set "HDMI Control" to "Off". Please consult the operating instructions for each connected device to check the settings. Refer to "HDMI control function" (page 73) for more information about the HDMI control function. <p>NOTE</p> <ul style="list-style-type: none"> When "HDMI Control" is set to "On", it consumes more standby power. If you are not using this unit for an extended period, it is recommended that you unplug the power cord from the power outlet. The HDMI control function controls operations of a TV that is compatible with the HDMI control function. Make sure that the TV and HDMI are connected when you perform HDMI control. If the "HDMI Control" settings have been changed, always reset the power to connected devices after the change.

Setting items	Setting details
Standby Source Sets the HDMI input source to put into standby when the power is on.	Last : Enters standby with the previously used input source. CBL/SAT / DVD / Blu-ray / GAME / AUX : Enters standby with each of the input sources assigned to each input terminal.  "Standby Source" can be set when "HDMI Control" is set to "On".
P.Off Control Links the power standby of this unit to external devices.	All : If power to a connected TV is turned off independently of the input source, power to this unit is automatically set to standby. Video : If power to a connected TV is turned off when the input source is CBL/SAT, DVD, Blu-ray, GAME, AUX power to this unit is automatically set to standby. Off : This unit does not link with power to a TV.  "P.Off Control" can be set when "HDMI Control" is set to "On".

Volume Display

Default settings are underlined.

Sets where to display the master volume level.

Setting items	Setting details
Volume	Bottom : Display at the bottom. Top : Display at the top. Off : Turn display off.  When the master volume display is hard to see when superimposed on movie subtitles, set to "Top".

Info.Display

Default settings are underlined.

Displays status of operation temporarily when the sound mode is changed or input source is switched. You can set whether or not to show each of these status displays.

Setting items	Setting details
On-Screen Info	<u>On</u> : Turn display on. <u>Off</u> : Turn display off.

Audio Display

Default settings are underlined.

Sets how long each menu is displayed when the input source is "NETWORK", "iPod/USB", or "FM".

Setting items	Setting details
Audio	<u>Always</u> : Show display continuously. <u>30s</u> : Show display for 30 seconds after operation. <u>10s</u> : Show display for 10 seconds after operation. <u>Off</u> : Turn display off.

TV Format

Default settings are underlined.

Set the video signal format to be output for the TV you are using.

Setting items	Setting details
Format	<p><u>NTSC</u> : Select NTSC output. <u>PAL</u> : Select PAL output.</p> <p></p> <p>"Format" can also be set by the following procedure. However, the menu screen is not displayed.</p> <ol style="list-style-type: none"> 1. Press and hold the main unit's TUNER PRESET CH + and STATUS for at least 3 seconds. "NTSC" appears on the display. 2. Use the main unit's SOURCE SELECT ◀ ▶ and set the video signal format. 3. Press the main unit's STATUS to complete the setting. <p>NOTE</p> <p>When a format other than the video format of the connected TV is set, the picture will not be displayed properly.</p>



Perform settings related to input source playback.

- You do not have to change the settings to use the unit. Make settings when needed.

Menu operation

1 Press **SETUP**.

The menu is displayed on the TV screen.

2 Use Δ / ∇ to select the menu to be set or operated.

3 Press **ENTER** or \triangleright to enter the setting.

- To return to the previous item, press \triangleleft or **BACK**.
- Exiting the Menu, press **SETUP** while the menu is displayed. The menu display disappears.

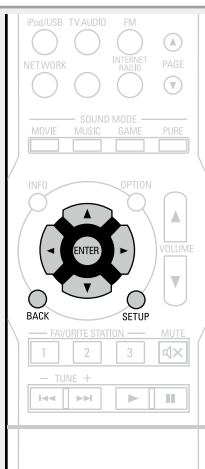

Important information

□ About the display of input sources

In this section, the configurable input sources for each item are shown as follows.

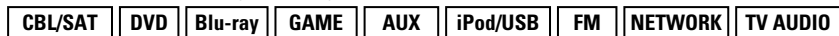

NOTE

Input sources that have been set to "Hide" at "Hide Source" ([page 91](#)) cannot be selected.

Items that can be set with the "Inputs" procedure

Digital Assign ([page 90](#))

Source Rename ([page 91](#))

Hide Source ([page 91](#))

Source Level ([page 91](#))

Input Select ([page 91](#))

Video Source ([page 92](#))

Digital Assign

This unit has certain input sources such as "CBL/SAT" assigned to audio and video connectors by default. By making the default connections, you can simply press an input source select button to play back audio or video from the connected device with ease. When making connections other than the default settings, you must change settings in this section.

Examples of "Digital Assign" menu screen displays

This screen appears when the "Inputs" – "each input source" – "Digital Assign" menu is selected. Use the "Digital Assign" menu to change the ② Digital input connectors that are assigned to the ① input sources in default settings.

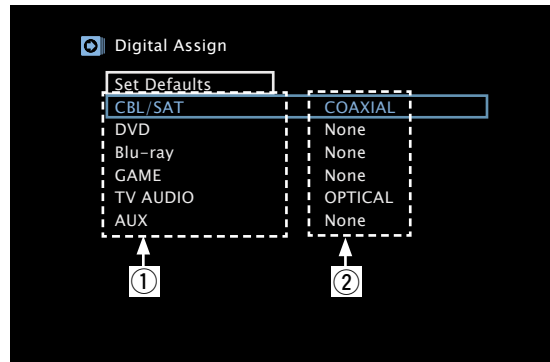

Input assignments menu operations

- 1** Use $\Delta \nabla \triangleleft \triangleright$ to move the cursor to the item you want to set, and then press **ENTER**.
- 2** Use $\triangleleft \triangleright$ to select the input connector to be assigned.
- 3** Press **ENTER** to register the setting.

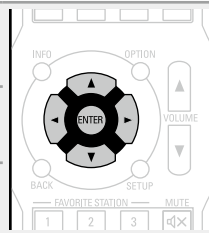

Setting items	Setting details										
DIGITAL Set this to change the digital input connectors assigned to the input sources.	COAXIAL / OPTICAL : Assign a digital input connector to the selected input source. None : Do not assign a digital input connector to the selected input source.										
	• At time of purchase, the settings of the different input sources are as shown below.										
	<table border="1"> <tr> <td>Input source</td> <td>CBL/SAT</td> <td>DVD</td> <td>Blu-ray</td> </tr> <tr> <td>Default setting</td> <td>COAXIAL</td> <td>None</td> <td>None</td> </tr> </table>	Input source	CBL/SAT	DVD	Blu-ray	Default setting	COAXIAL	None	None		
Input source	CBL/SAT	DVD	Blu-ray								
Default setting	COAXIAL	None	None								
	<table border="1"> <tr> <td>Input source</td> <td>GAME</td> <td>AUX</td> <td>TV AUDIO</td> </tr> <tr> <td>Default setting</td> <td>None</td> <td>None</td> <td>OPTICAL</td> </tr> </table>	Input source	GAME	AUX	TV AUDIO	Default setting	None	None	OPTICAL		
Input source	GAME	AUX	TV AUDIO								
Default setting	None	None	OPTICAL								
Set Defaults The input source name is returned to the default setting.	Yes : Reset to the defaults. No : Do not reset to the defaults.										
	If you select "Set Defaults" and press ENTER , the message "Reset to the default values?" is displayed. Select "Yes" or "No", and then press ENTER .										

Source Rename

Change the display name of the selected input source.

This is convenient when the input source name of your device and the input source name of this unit are different. You can change the name to suit your needs. When the renaming is completed, the name is displayed on this unit's display and on the menu screen.

Setting details

CBL/SAT / DVD / Blu-ray / GAME / AUX / TV AUDIO : Change the display name of the selected input source.

- Up to 12 characters can be input.
- For character input, see [page 79](#).

Set Defaults : The input source name is returned to the default setting.

- **Yes** : Reset to the defaults.
- **No** : Do not reset to the defaults.

 If you select "Set Defaults" and press **ENTER**, the message "Reset to the default values?" is displayed. Select "Yes" or "No", and then press **ENTER**.

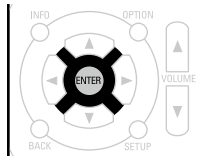

Hide Source

Default settings are underlined.

Remove from the display input sources that are not used.

Setting details

CBL/SAT / DVD / Blu-ray / GAME / AUX / iPod/USB / FM / NETWORK / TV AUDIO : Select input source that is not used.

- **Show** : Use this source.
- **Hide** : Do not use this source.

NOTE

Input sources set to "Hide" cannot be selected using the input source select button.

Source Level

Default settings are underlined.

- This function corrects the playback level of the selected input source's audio input.
- Make this setting if there are differences in the input volume levels between the different sources.

Setting details

-12dB – +12dB (0dB)

 The analog input level and digital input level can be adjusted independently for input sources for which "DIGITAL" is assigned at "Digital Assign" ([page 90](#)).

Input Select

Default settings are underlined.

Set the audio input mode and decode mode of each input source.

The input modes available for selection may vary depending on the input source.

Setting items	Setting details
Input Mode Set the audio input modes for the different input sources. It is normally recommended to set the audio input mode to "Auto".	<p>Auto : Automatically detect input signal and perform playback.</p> <p>HDMI : Play only signals from HDMI input.</p> <p>Digital : Play only signals from digital input.</p> <p>Analog : Play only signals from analog input.</p> <p></p> <ul style="list-style-type: none"> • "Digital" can be set for input sources for which "DIGITAL" is assigned at "Digital Assign" (page 90). • If the input source is set to "CBL/SAT" or "DVD", it can be set to "Analog". • When digital signals are properly input, the DIG. indicator lights on the display. If the DIG. indicator does not light, check "Digital Assign" (page 90) and the connections. • If "HDMI Control" is set to "On" and a TV compatible with the ARC is connected via the HDMI MONITOR connectors, the input mode whose input source is "TV" is fixed to ARC.

 See overleaf

Setting items	Setting details
Decode Mode Set the audio decode mode for input source. <div style="display: flex; flex-wrap: wrap; gap: 5px;"> <div style="border: 1px solid black; padding: 2px 5px;">CBL/SAT</div> <div style="border: 1px solid black; padding: 2px 5px;">DVD</div> <div style="border: 1px solid black; padding: 2px 5px;">Blu-ray</div> <div style="border: 1px solid black; padding: 2px 5px;">GAME</div> <div style="border: 1px solid black; padding: 2px 5px;">AUX</div> <div style="border: 1px solid black; padding: 2px 5px;">TV AUDIO</div> </div>	<p>Auto : Detect type of digital input signal and decode and play automatically.</p> <p>PCM : Decode and play only PCM input signals.</p> <p>DTS : Decode and play only DTS input signals.</p> <p></p> <ul style="list-style-type: none"> This item can be set for input sources for which "DIGITAL" is assigned at "Digital Assign" (page 90). Normally set this mode to "Auto". Set "PCM" and "DTS" when inputting the corresponding input signal.

Video Source

Default settings are underlined.

Video of another input source is played back combined with the playing audio.

Setting items	Setting details
Video Select	<p>Default : Play the picture and sound of the input source.</p> <p>CBL/SAT / DVD : Select video input source to view. The video of the selected input source is played along with the audio currently being played. This can be set for individual input sources.</p> <p>NOTE</p> <ul style="list-style-type: none"> It is not possible to select HDMI input signals. Input sources for which "Hide" is selected at "Hide Source" (page 91) cannot be selected.



Set when changing Audyssey® Setup settings.

- If you change the speaker settings after performing Audyssey® Setup, it will not be possible to set Audyssey MultEQ®, Audyssey Dynamic EQ® and Audyssey Dynamic Volume® (☞ page 84).
- Can be used without changing the settings. Please set if necessary.

Menu operation

1 Press **SETUP**.

The menu is displayed on the TV screen.

2 Use Δ / ∇ to select the menu to be set or operated.

3 Press **ENTER** or \triangleright to enter the setting.

- To return to the previous item, press \triangleleft or **BACK**.
- Exiting the Menu, press **SETUP** while the menu is displayed. The menu display disappears.

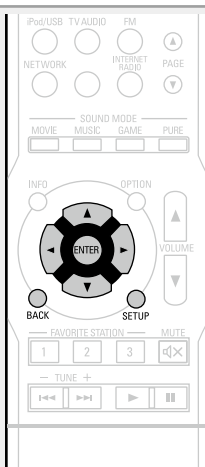

Items that can be set with the “Speakers” procedure

Audyssey® Setup (☞ page 20)





Manual Setup (☞ page 94)

Manual Setup

Default settings are underlined.



Perform when setting the speakers manually or when changing settings made in Audyssey® Setup.



- If you change the speaker settings after performing Audyssey® Setup, it will not be possible to select Audyssey MultEQ®, Audyssey Dynamic EQ® and Audyssey Dynamic Volume® ([page 84](#)).
- “Manual Setup” can be used without changing the settings. Please set if necessary.

Setting items	Setting details
<p>Speaker Config. Indicate speaker presence and select speaker size categories based on bass reproduction capability.</p> <p>NOTE Do not use the outward shape of the speaker to determine selection of a “Large” or “Small” speaker. Instead, use the frequencies set in “Crossovers” (page 96) as the standard for determining bass reproduction capability.</p>	<p>Front : Set the front speaker size.</p> <ul style="list-style-type: none"> • Large : Use a large speaker that can adequately play back low frequencies. • Small : Use a small speaker that has inadequate playback capacity for low frequencies. <p> When “Subwoofer” is set to “No”, “Front” is automatically set to “Large”.</p> <p> When “Front” is set to “Small”, “Center” and “Surround” can not be set to “Large”.</p> <hr/> <p>Center : Set the presence and size of the center speaker.</p> <ul style="list-style-type: none"> • Large : Use a large speaker that can adequately play back low frequencies. • Small : Use a small speaker that has inadequate playback capacity for low frequencies. • None : Select when a center speaker is not connected. <p> “Large” is not displayed when “Front” is set to “Small”.</p> <hr/> <p>Subwoofer : Set the presence of a subwoofer.</p> <ul style="list-style-type: none"> • Yes : Use a subwoofer. • No : Select when a subwoofer is not connected. <p> When “Front” is set to “Small”, “Subwoofer” is automatically set to “Yes”.</p> <hr/> <p>Surround : Set the presence and size of the surround speakers.</p> <ul style="list-style-type: none"> • Large : Use a large speaker that can adequately play back low frequencies. • Small : Use a small speaker that has inadequate playback capacity for low frequencies. • None : Select when the surround speakers are not connected.

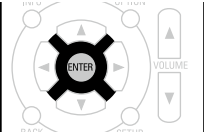
Setting items	Setting details
<p>Bass Set subwoofer and LFE signal range playback.</p>	<p>Subwoofer Mode : Select low range signals to be reproduced by subwoofer.</p> <ul style="list-style-type: none"> • LFE : The low range signal of the channel set to “Small” speaker size is added to the LFE signal output from the subwoofer. • LFE+Main : The low range signal of all channels is added to the LFE signal output from the subwoofer. <p> “Subwoofer Mode” can be set when “Speaker Config.” – “Subwoofer” (page 94) is set to “Yes”.</p> <ul style="list-style-type: none"> • Play music or a movie source and select the mode offering the strongest bass. • Select “LFE+Main” if you want the bass signals to always be produced from the subwoofer. <p>NOTE If “Front” and “Center” for “Speaker Config.” are set to “Large”, and “Subwoofer Mode” is set to “LFE”, no sound may be output from the subwoofers, depending on the input signal or selected sound mode.</p> <p>LPF for LFE : Set LFE signal playback range. Set this when you want to change the playback frequency of the subwoofer.</p> <p>• 80Hz / 90Hz / 100Hz / 110Hz / 120Hz / 150Hz / 200Hz / 250Hz</p>

 [See overleaf](#)

Setting items	Setting details
Distances Set distance from listening position to speakers. Measure beforehand the distance from the listening position to each speaker.	<p>Unit : Set the unit of distance.</p> <ul style="list-style-type: none"> • Feet / Meters <p>Step : Set the minimum variable width of the distance.</p> <ul style="list-style-type: none"> • 1ft / 0.1ft • 0.1m / 0.01m <p>Set Defaults: The “Distances” settings are returned to the default settings.</p> <ul style="list-style-type: none"> • Yes : Reset to the defaults. • No : Do not reset to the defaults. <p> When you select “Set Defaults” and press ENTER, the “Reset to the default values?” prompt is displayed. Select either “Yes” or “No”, and press ENTER.</p> 
	<p>Front L / Front R / Center / Subwoofer / Surround L / Surround R : Select speaker for distance setting.</p> <ul style="list-style-type: none"> • 0.0ft – 60.0ft / 0.00m – 18.00m : Set the distance. <p> Default settings :</p> <ul style="list-style-type: none"> Front L / Front R / Center / Subwoofer : 12.0 ft (3.60 m) Surround L / Surround R : 10.0 ft (3.00 m) <ul style="list-style-type: none"> • Set the difference in the distance between the speakers to less than 20.0 ft (6.00 m). <p>NOTE</p> <p>Speakers set to “None” in “Speaker Config.” (page 94) are not displayed.</p>

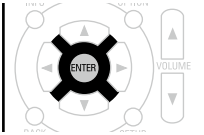
Setting items	Setting details
Levels Set the volume of the test tone to be the same when it is output from each speaker.	<p>Test Tone Start : Output test tone.</p> <ul style="list-style-type: none"> • Front L / Center / Front R / Surround R / Surround L / Subwoofer : Select speaker to output test tone. • -12.0dB – +12.0dB (0.0dB) : Adjust the volume. <p> When “Levels” is adjusted, the adjusted values are set for all the sound modes.</p> <p>NOTE</p> <ul style="list-style-type: none"> • Speakers set to “None” in the “Speaker Config.” (page 94) settings are not displayed. • When a headphones jack is inserted in the PHONES jack of this unit, the “Levels” is not displayed. <p>Set Defaults : The “Levels” settings are returned to the default settings.</p> <ul style="list-style-type: none"> • Yes : Reset to the defaults. • No : Do not reset to the defaults. <p> When you select “Set Defaults” and press ENTER, the “Reset to the default values?” prompt is displayed. Select either “Yes” or “No”, and press ENTER.</p> 

 See overleaf

Setting items	Setting details
<p>Crossovers</p> <p>Set the maximum frequency of the bass signal output from each channel to the subwoofer. Set the Crossover Frequency to suit the bass reproduction capability of the speaker being used.</p>	<p>Crossover : Set the crossover frequency.</p> <ul style="list-style-type: none"> • 40Hz / 60Hz / 80Hz / 90Hz / 100Hz / 110Hz / 120Hz / 150Hz / 200Hz / 250Hz / Individual : Set the crossover frequency for all speakers. See the speaker manual for information concerning speaker crossover frequency. <p>The following settings can be set when the “Crossover” setting is set to “Individual”.</p> <ul style="list-style-type: none"> • Front / Center / Surround : Select speaker for setting of crossover frequency. • 40Hz / 60Hz / 80Hz / 90Hz / 100Hz / 110Hz / 120Hz / 150Hz / 200Hz / 250Hz : Set the crossover frequency. <p></p> <ul style="list-style-type: none"> • “Crossovers” can be set when the “Bass” – “Subwoofer Mode” (page 94) setting is “LFE+Main”, or when you have a speaker that is set to “Small”. • Always set the crossover frequency to “80Hz”. When using small speakers, however, we recommend setting the crossover frequency to a higher frequency. • For speakers set to “Small”, sound below the crossover frequency is cut from the sound output. The cut bass sound is output from the subwoofer or front speakers. • The speakers that can be set when “Individual” is selected differ depending on to the “Subwoofer Mode” setting (page 94). <ul style="list-style-type: none"> • When “LFE” is selected, speakers set to “Small” at “Speaker Config.” can be set. If the speakers are set to “Large”, “Full Band” is displayed and the setting cannot be made. • If set to “LFE+Main”, this setting can be made regardless of the speaker size.



To use this unit by connecting it to a home network (LAN), you must configure network settings. If you set up your home network (LAN) via DHCP, set "DHCP" to "On" (use the default setting). This allows this unit to use your home network (LAN).

If you assign an IP address for each device, you must use the "IP Address" setting to assign an IP address to this unit and enter the information about your home network (LAN) such as the gateway address and subnet mask.

Menu operation

- 1 Press SETUP.**
The menu is displayed on the TV screen.
- 2 Use Δ / ∇ to select the menu to be set or operated.**
- 3 Press ENTER or \triangleright to enter the setting.**
 - To return to the previous item, press \triangleleft or **BACK**.
 - Exiting the Menu, press **SETUP** while the menu is displayed.
The menu display disappears.

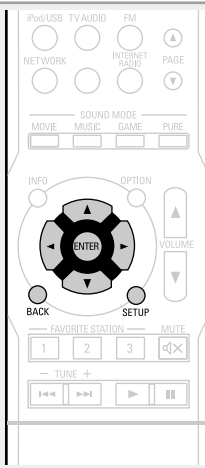

Items that can be set with the "Network" procedure

Information (page 98)

IP Control (page 98)

Friendly Name (page 98)

Settings (page 99)

Information

Display network information.

Setting details

Friendly Name / DHCP=On or Off / IP Address / MAC Address

 MAC Address is required to make a vTuner account.

IP Control

Default settings are underlined.

Set the network function on/off during standby.

Setting details

Always On : Network is on during standby. Main unit operable with a network compatible controller.

Off In Standby : Suspend network function during standby.

NOTE

When "IP Control" is set to "Always On", it consumes more standby power.

Friendly Name

The Friendly Name is the name of this unit displayed on the network. You can change the Friendly Name according to your preferences.

Setting items

Edit Name

Edits Friendly Name.

Set Defaults

Restores Friendly Name, which you had changed, to the default setting.

Setting details

- The default Friendly Name on first use is "DENON:[AVR-1613]".
- Up to 63 characters can be input.
- For character input, see [page 79](#).

Yes : Reset to the defaults.

No : Do not reset to the defaults.

 When you select "Set Defaults" and press **ENTER**, the "Reset to the default values?" prompt is displayed. Select either "Yes" or "No", and press **ENTER**.

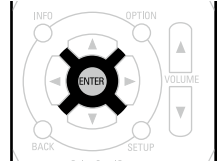

Settings

Default settings are underlined.

Make settings for wired LAN.

Only set "Settings" when connecting to a network without a DHCP function.

Setting details

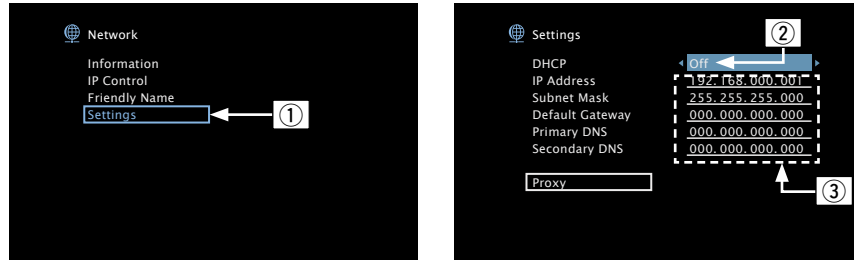

① On the menu, select "Network" – "Settings" and press **ENTER**.

② Use $\Delta \nabla \triangleleft \triangleright$ to set "DHCP" to "Off", then press **ENTER**.

The DHCP function is disabled.

③ Use $\Delta \nabla \triangleleft \triangleright$ to input the address and press **ENTER**.

• **IP Address** : Set the IP address within the ranges shown below.

The Network Audio function cannot be used if other IP addresses are set.

CLASS A: 10.0.0.1 – 10.255.255.254

CLASS B: 172.16.0.1 – 172.31.255.254

CLASS C: 192.168.0.1 – 192.168.255.254

• **Subnet Mask** : When connecting an xDSL modem or terminal adapter directly to this unit, input the subnet mask indicated in the documentation supplied by your provider. Normally input 255.255.255.0.

• **Default Gateway** : When connected to a gateway (router), input its IP address.

• **Primary DNS, Secondary DNS** : If there is only one DNS address indicated in the documentation supplied by your provider, input it at "Primary DNS". If there are two or more DNS addresses, input the first one at "Secondary DNS".

④ Press **BACK**.

The display returns to the playback screen.

• When connecting to the network via a Proxy server, select "Proxy" and press **ENTER** (see page 100 "Proxy settings").

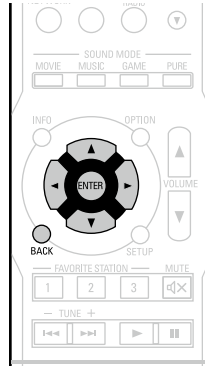

Setting details



- If you are using a broadband router (DHCP function), there is no need to make the settings at "IP Address" and "Proxy", since the DHCP function is set to "On" in this unit's default settings.
- If this unit is being used connected to a network without the DHCP function, the network settings must be made. In this case, some knowledge of networks is required. For details, consult a network administrator.
- If you cannot connect to the Internet, recheck the connections and settings (see page 18).
- If you do not understand about Internet connection, contact your ISP (Internet Service Provider) or the store from which you purchased your computer.
- When you want to cancel the setting during IP address input, press \triangleleft or **BACK**.

See overleaf

Setting details

Proxy settings

Make this setting when connecting to the Internet via a proxy server.

Make the proxy settings only when you connect to the Internet via a proxy server that is on your internal network or provided by your provider, etc.

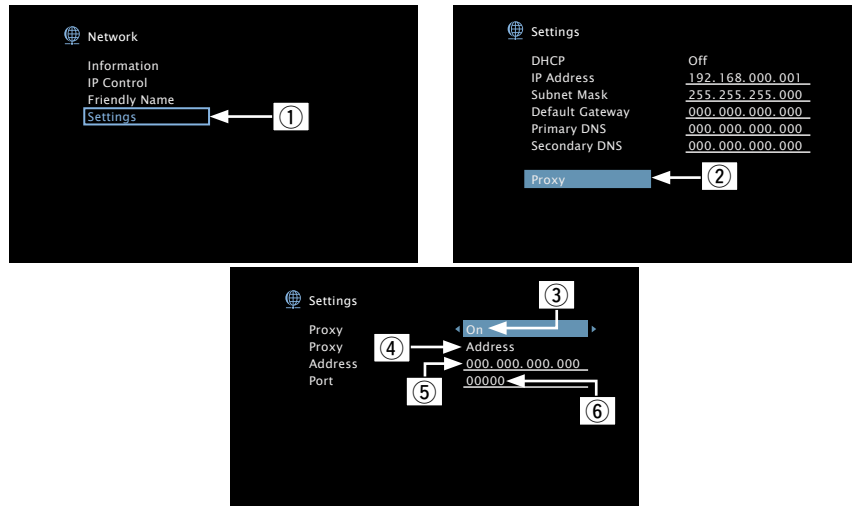

① On the menu, select “Network” – “Settings” and press **ENTER**.

② Use $\Delta \nabla$ to set “Proxy” and press **ENTER**.

③ Use $\triangleleft \triangleright$ to set “Proxy” to “On” and press ∇ .

The proxy server is enabled.

④ Use $\triangleleft \triangleright$ to select the proxy server input method, and then press **ENTER**.

Address : Select when inputting by address.

Name : Select when inputting by domain name.

⑤ Press ∇ and **ENTER** (select Address or Name). Use $\Delta \nabla \triangleleft \triangleright$ to input the proxy server address or domain name and press **ENTER**.

When “Address” is selected in step ④ : Input the address

When “Name” is selected in step ④ : Input the domain name

• For character input, see [page 79](#).

⑥ Press ∇ and **ENTER** (select Port). Use $\Delta \nabla \triangleleft \triangleright$ to input the proxy server port number and press **ENTER**.

Setup is complete.

⑦ Press **BACK**.

The display returns to the playback screen.

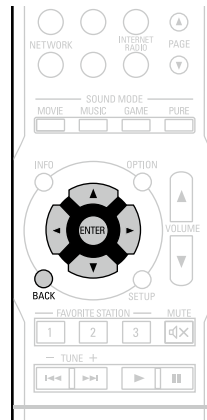



Make various other settings.

Menu operation

1 Press **SETUP**.

The menu is displayed on the TV screen.

2 Use Δ / ∇ to select the menu to be set or operated.

3 Press **ENTER** or \triangleright to enter the setting.

- To return to the previous item, press \triangleleft or **BACK**.
- Exiting the Menu, press **SETUP** while the menu is displayed. The menu display disappears.

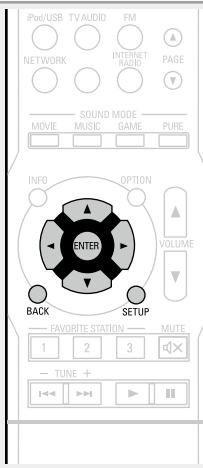

Items that can be set with the “General” procedure

Language (👉 page 102)

Quick Sel.Names (👉 page 102)

Auto Standby (👉 page 102)

Front Display (👉 page 102)

Information (👉 page 103)

Firmware (👉 page 104)

Setup Lock (👉 page 105)

Language

Default settings are underlined.

Set the language for display on the menu screen.

Setting details

English / Español



“Language” can also be set by the following procedure. However, the menu screen is not displayed. Following the display content to make the setting.

1. Press and hold the main unit’s **TUNER PRESET CH +** and **STATUS** for at least 3 seconds. “NTSC” appears on the display.
2. Press the main unit’s **DIMMER** and set “ENGLISH”.
3. Use the main unit’s **SOURCE SELECT** ◀ ▶ and set the language.
4. Press the main unit’s **STATUS** to complete the setting.

Quick Sel.Names

Change the “Quick Select” display title to one you prefer.

Setting details

Quick Select 1 / Quick Select 2 / Quick Select 3 / Quick Select 4

- Up to 16 characters can be input.
- For character input, see [page 79](#).

Auto Standby

Default settings are underlined.

When you do not perform any operation on this unit with no audio or video input for a specified time, this unit automatically enters the standby mode. Before it enters the standby mode, “Auto Standby” is displayed on the display of this unit and the menu screen.

Setting details

- 30min** : The unit goes into standby after 30 minutes.
- 60min** : The unit goes into standby after 60 minutes.
- Off** : The unit does not go into standby automatically.

Front Display

Default settings are underlined.

Adjust the display brightness of this unit.

Setting items	Setting details
Dimmer	<p>Bright : Normal display brightness. Dim : Reduced display brightness. Dark : Very low display brightness. Off : Turns the display off.</p> <p> Buttons on the main unit can be used for operations. Each time DIMMER is pressed, the setting is changed as shown below.</p> <div style="text-align: center;"> <pre> graph TD Bright --> Dim Dim --> Dark Dark --> Off Off --> Bright </pre> </div> <p>NOTE When “Dimmer” is set to “Off”, the display turns off and appears as if there is no electricity.</p>

Information

Show information about receiver settings, input signals, etc.

Items	Setting details
Audio Show information about audio input signals.	<p>Sound Mode : The currently set surround mode. Signal : The input signal type. Format : The number of input signal channels (presence of front, surround, LFE). Sample rate : The input signal's sampling frequency. Offset : The dialogue normalization correction value. Flag : This is displayed when inputting signals including a surround back channel. "MATRIX" is displayed with Dolby Digital EX and DTS-ES Matrix signals, "DISCRETE" with DTS-ES Discrete signals.</p> <div style="border: 1px solid black; padding: 5px; margin: 10px 0;"> <p style="text-align: center;">Dialogue normalization function</p> <p>This function is automatically activated when playing Dolby Digital sources. It automatically corrects the standard signal level for individual program sources. The correction value can be checked using the STATUS on the main unit.</p> <div style="border: 1px solid black; padding: 5px; margin: 10px auto; width: fit-content;"> <p style="text-align: center;">Offset: - 4dB</p> </div> <p style="text-align: center;">The figure is the corrected value. This cannot be changed.</p> </div>
Video Show information about HDMI input/output signals and monitor.	<p>Signal</p> <ul style="list-style-type: none"> • Resolution / Color Space / Pixel Depth <p>Monitor</p> <ul style="list-style-type: none"> • Interface / Resolutions
Status Show information about current settings.	<p>The information displayed differs according to the input source.</p> <ul style="list-style-type: none"> • Select Source / Name / Sound Mode / Input Mode / Decode Mode / Digital Assign / Video Select
Firmware	<p>Version : Displays information for the current firmware.</p>



Press **INFO** to display current source name, volume and sound mode name at the bottom of the screen.

Examples of screen display

• Status display screen
 When the input source is switched.

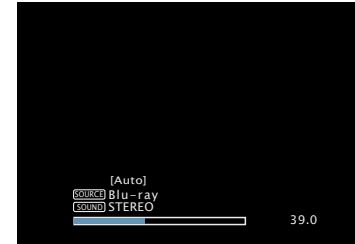

When the volume is adjusted.

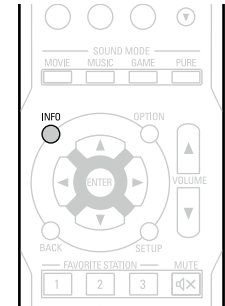
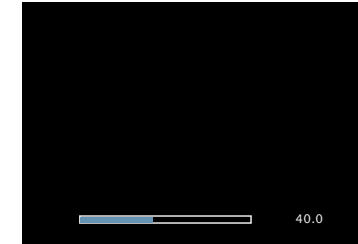

Status display: The operating status appears briefly on the screen when the input source is switched or the volume is changed.

NOTE

The status display screen cannot be displayed at a computer's resolution (e.g. VGA) or while certain 3D video contents is being played.





Firmware

Default settings are underlined.

Set whether or not to check for firmware update, update the firmware, and display update and upgrade notifications.

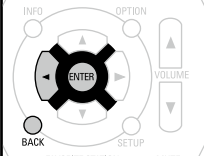
Setting items	Setting details												
<p>Update Update the firmware of the receiver.</p> <p>NOTE In cases where it is not possible to connect to the network after doing a firmware update, connect to the network again using "Network" (☞ page 97).</p>	<p>Check for Update : Check for firmware updates. You can also check approximately how long it will take to complete an update. Update Start : Execute the update process. When updating starts, the power indicator becomes red and the menu screen is shut down. The amount of update time which has elapsed is displayed. When updating is complete, the power indicator becomes green and normal status is resumed.</p> <ul style="list-style-type: none"> • If updating fails, the set automatically retries, but if updating is still not possible, one of the messages shown below is displayed. If the display reads as shown below, check the settings and network environment, then update again. <table border="1"> <thead> <tr> <th>Display</th> <th>Description</th> </tr> </thead> <tbody> <tr> <td>Updating fail</td> <td>Updating failed.</td> </tr> <tr> <td>Login failed</td> <td>Failure to log into server.</td> </tr> <tr> <td>Server is busy</td> <td>Server is busy. Wait a while then try again.</td> </tr> <tr> <td>Connection fail</td> <td>Failure in connecting to server.</td> </tr> <tr> <td>Download fail</td> <td>Downloading of the firmware has failed.</td> </tr> </tbody> </table>	Display	Description	Updating fail	Updating failed.	Login failed	Failure to log into server.	Server is busy	Server is busy. Wait a while then try again.	Connection fail	Failure in connecting to server.	Download fail	Downloading of the firmware has failed.
Display	Description												
Updating fail	Updating failed.												
Login failed	Failure to log into server.												
Server is busy	Server is busy. Wait a while then try again.												
Connection fail	Failure in connecting to server.												
Download fail	Downloading of the firmware has failed.												

Setting items	Setting details
<p>Notifications Displays a notification message on this unit's menu screen when the latest firmware is released with "Update". Display a notification message on this unit's menu screen when downloadable firmware is released with "Add New Feature".</p>	<p>Update : The notification message is displayed for about 20 seconds when the power is turned on. Connect to broadband Internet (☞ page 18) when using this function.</p> <ul style="list-style-type: none"> • On : Display update message. • Off : Do not display update message. <p> When you press ENTER during display of the notification message, the "Check for Update" screen is displayed (Refer to page 104 for more information on "Update").</p> <p>• Press ◀ or BACK to erase the notification message.</p>  <p>Upgrade : The notification message is displayed for about 20 seconds when the power is turned on. Connect to broadband Internet (☞ page 18) when using this function.</p> <ul style="list-style-type: none"> • On : Display upgrade message. • Off : Do not display upgrade message. <p> When you press ENTER during display of the notification message, the "Add New Feature" screen is displayed (Refer to page 105 for more information on "Add New Feature").</p> <p>• Press ◀ or BACK to erase the notification message.</p>

 See overleaf



Setting items	Setting details
<p>Add New Feature Display new features that can be downloaded to this unit and perform an upgrade.</p> <p>NOTE In cases where it is not possible to connect to the network after adding a new function, connect to the network again using "Network" (🔗 page 97).</p>	<p>Upgrade Status : Display a list of the additional functions provided by the upgrade. Upgrade : Execute the upgrade process. When the upgrade starts, the power indicator becomes red and the menu screen is shut down. During the upgrade, the amount of upgrade time which has elapsed is displayed. When upgrading is complete, the power indicator becomes green and normal status is resumed.</p> <ul style="list-style-type: none"> • If the upgrade is not successful, an error message identical to those in "Firmware Update" will appear on the display. Check the settings and network environment and then perform the upgrade again. <p>🔧 See the DENON website for details about upgrades. When the procedure is complete, "Registered" is displayed in this menu and upgrades can be carried out. If the procedure has not been carried out, "Not Registered" is displayed. The ID number shown on this screen is needed when carrying out the procedure. The ID number can also be displayed by pressing and holding the main unit's SOURCE ◀ and SOURCE ▶ for at least 3 seconds.</p>

Notes concerning use of "Update" and "Add New Feature"
<ul style="list-style-type: none"> • In order to use these functions, you must have the correct system requirements and settings for a broadband Internet connection (🔗 page 18). • Do not turn off the power until updating or upgrading is completed. • Even with a broadband connection to the Internet, approximately 1 hour is required for the updating/upgrading procedure to be completed. • Once updating/upgrade starts, normal operations on this unit cannot be performed until updating/upgrading is completed. Furthermore, there may be cases where backup data is reset for the parameters, etc., set on this unit. • If the update or upgrade fails, press and hold the ⏻ on the main unit for more than 5 seconds, or remove and re-insert the power cord. "Update retry" appears on the display and update restarts from the point at which update failed. If the error continues despite this, check the network environment.

- 🔧
- Information regarding the "Update" function and "Add New Feature" will be announced on the DENON web site each time related plans are defined.
 - When usable new firmware is released with "Update" or "Add New Feature", a notification message is displayed on the menu screen. When you do not want to be notified, set "Notifications" – "Update" (🔗 page 104) and "Notifications" – "Upgrade" (🔗 page 104) to "Off".

Setup Lock





Default settings are underlined.

Protect settings from inadvertent change.

Setting items	Setting details
Lock	<p>On : Turn protection on. Off : Turn protection off.</p> <p>🔧 When canceling the setting, set "Lock" to "Off".</p> <p>NOTE When "Lock" is set to "On", the settings listed below can no longer be changed. Also, "SETUP LOCKED!" is displayed if you attempt to operate related settings.</p> <ul style="list-style-type: none"> • Setup menu operations • Levels

Information

Here, we list various information related to this unit.
Please refer to this information as needed.

- Part names and functions  [page 107](#)
- Other information  [page 112](#)
- Troubleshooting  [page 119](#)
- Specifications  [page 124](#)
- Index  [page 125](#)

Part names and functions

Front panel

For buttons not explained here, see the page indicated in parentheses ().

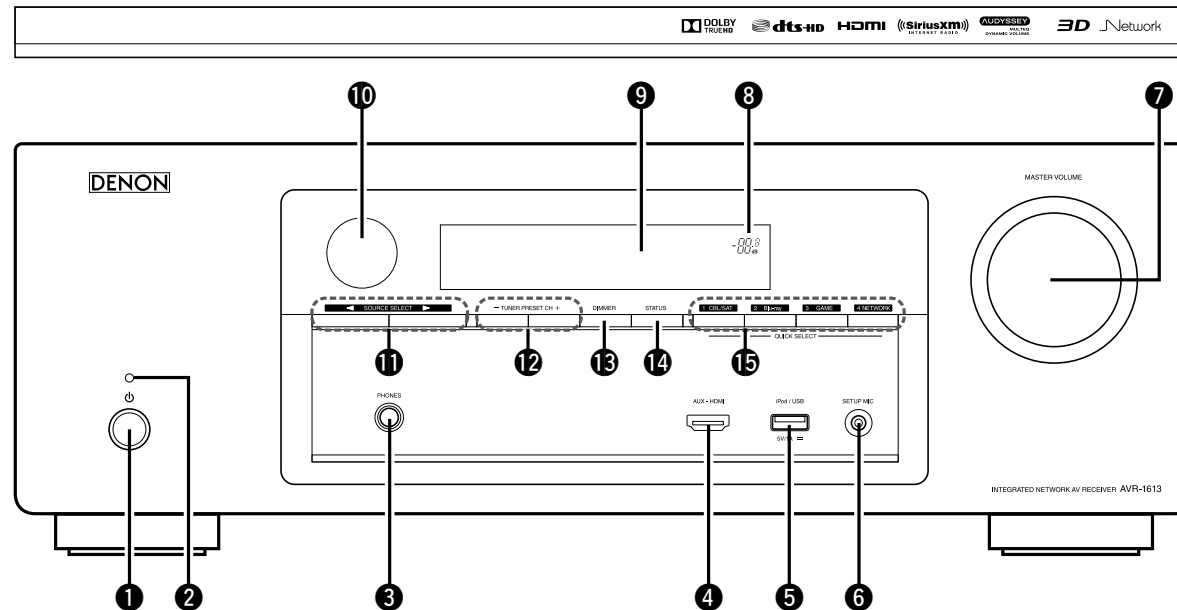

- | | | |
|--|---|--|
| <p>1 Power operation button (b) (27)
Turns power to this unit on and off (standby).</p> <p>2 Power indicator (27)
[Power indicator status]</p> <ul style="list-style-type: none"> • Power on : Green • Normal standby : Off • When “HDMI Control” (☞ page 87) is set to “On” : Red • When “IP Control” (☞ page 98) is set to “Always On” : Red <p>3 Headphones jack (PHONES)
When the headphones are plugged into this jack, audio will no longer be output from the connected speakers.</p> | <p>4 AUX-HDMI connector (10)</p> <p>5 iPod/USB port (16)</p> <p>6 SETUP MIC jack (21)</p> <p>7 MASTER VOLUME knob (28)</p> <p>8 Master volume indicator</p> <p>9 Display (108)</p> <p>10 Remote control sensor (111)</p> | <p>11 SOURCE SELECT buttons (◀▶) (27, 123)</p> <p>12 Tuner preset channel buttons (TUNER PRESET CH +, -) (39)</p> <p>13 DIMMER button (102)</p> <p>14 STATUS button (30, 44, 48, 103)</p> <p>15 QUICK SELECT buttons (75)</p> |
|--|---|--|

NOTE

To prevent hearing loss, do not raise the volume level excessively when using headphones.

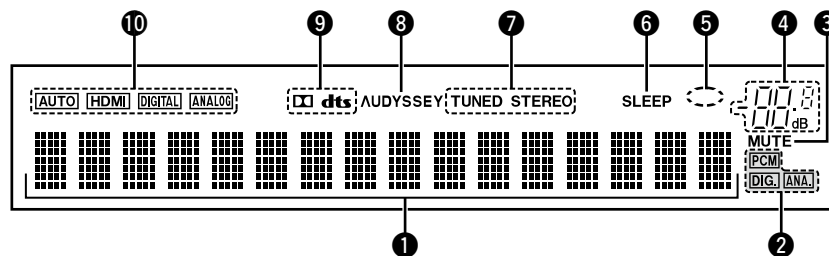

1 Information display

The input source name, sound mode, setting values and other information are displayed here.

2 Input signal indicators

3 MUTE indicator

This lights when the mute mode is selected ([page 28](#)).

4 Master volume indicator

5 Circle indicator

Circle indicator is displayed when the input source is "NETWORK" or "iPod/USB" when you are playing back music.

6 Sleep timer indicator

This lights when the sleep mode is selected ([page 74](#)).

7 Tuner reception mode indicators

These light according to the reception conditions when the input source is set to "FM".

STEREO : In FM mode, this lights up when receiving analog stereo broadcasts.

TUNED : Lights up when the broadcast is properly tuned in.

8 Audyssey® indicator

This indicator lights when the "MultEQ®" ([page 84](#)), "Dynamic EQ®" ([page 84](#)), or "Dynamic Volume®" ([page 84](#)) setting is set to "On".

9 Decoder indicators

These light when Dolby or DTS signals are input or when the Dolby or DTS decoder is running.

10 Input mode indicators

Set the audio input modes for the different input sources ([page 91](#)).

Rear panel

See the page indicated in parentheses ().

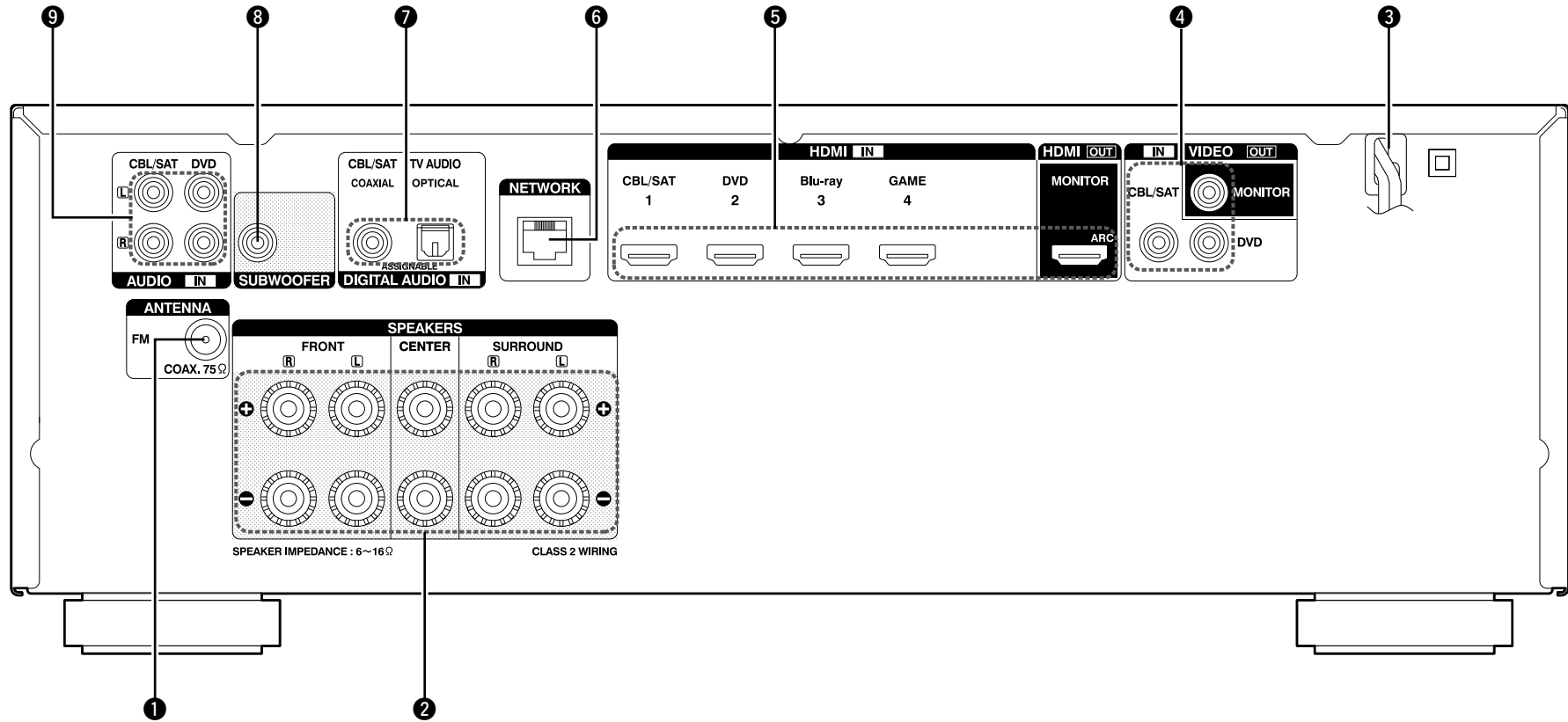

- ① FM antenna terminal (ANTENNA) (17)
- ② Speaker terminals (SPEAKERS) (71, 72)
- ③ Power cord (19)
- ④ Video connectors (VIDEO) (13, 14, 15)
- ⑤ HDMI connectors (9, 10)
- ⑥ Network connector (NETWORK) (18)
- ⑦ Digital audio connectors (DIGITAL AUDIO) (13, 14, 15)
- ⑧ Subwoofer connector (SUBWOOFER) (71, 72)
- ⑨ Analog audio connectors (AUDIO) (14, 15)

NOTE

Do not touch the inner pins of the connectors on the rear panel. Electrostatic discharge may cause permanent damage to the unit.



Remote control unit

For buttons not explained here, see the page indicated in parentheses ().

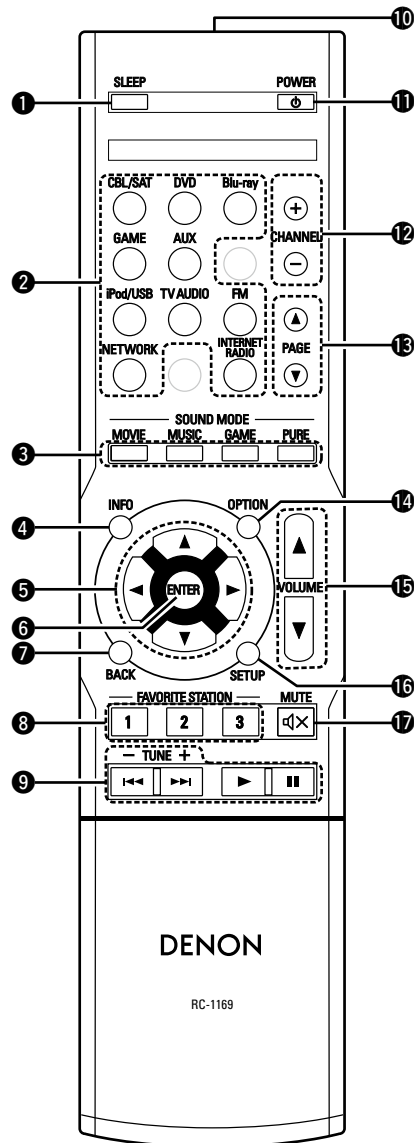

- 1 **SLEEP button** (74)
- 2 **Input source select buttons** (27)
- 3 **SOUND MODE buttons** (64)
 - MOVIE button
 - MUSIC button
 - GAME button
 - PURE button
- 4 **Information button (INFO)** (103)
- 5 **Cursor buttons** (▲▼◀▶) (78, 80, 86, 89, 93, 97, 101)
- 6 **ENTER button** (78, 80, 86, 89, 93, 97, 101)
- 7 **BACK button** (80, 86, 89, 93, 97, 101)
- 8 **FAVORITE STATION buttons (1 – 3)** (60)
- 9 **System buttons** (31, 34, 49, 55)
 - Skip buttons (◀◀, ▶▶)
 - Play button (▶)
 - Pause button (⏸)
- Tuning up / Tuning down buttons (TUNE +, -)** (35, 36)
- 10 **Remote control signal transmitter** (111)
- 11 **POWER button** (⏻) (27)
- 12 **CHANNEL buttons (+, -)** (39)
- 13 **PAGE buttons (▲▼)** (31, 34, 45, 49, 52, 55, 57)
- 14 **OPTION button** (29, 33, 35, 44, 49, 51)
- 15 **VOLUME buttons (▲▼)** (28)
- 16 **SETUP button** (80, 86, 89, 93, 97, 101)
- 17 **MUTE button** (⏻) (28)

See overleaf

Inserting the batteries

- 1 Remove the rear lid in the direction of the arrow and remove it.
- 2 Load the two batteries properly as indicated by the marks in the battery compartment.

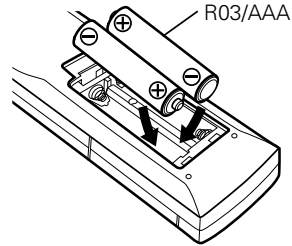
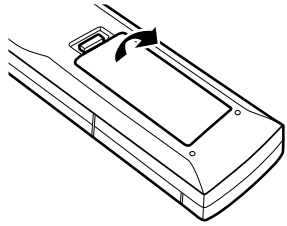

- 3 Put the rear cover back on.

NOTE

- Insert the specified batteries in the remote control unit.
- Replace the batteries with new ones if the set does not operate even when the remote control unit is operated close to the unit. (The supplied batteries are only for verifying operation. Replace them with new batteries at an early date.)
- When inserting the batteries, be sure to do so in the proper direction, following the ⊕ and ⊖ marks in the battery compartment.
- To prevent damage or leakage of battery fluid:
 - Do not use a new battery together with an old one.
 - Do not use two different types of batteries.
 - Do not attempt to charge dry batteries.
 - Do not short-circuit, disassemble, heat or dispose of batteries in flames.
 - Do not keep the battery in a place exposed to direct sunlight or in places with extremely high temperatures, such as near a heater.
- If the battery fluid should leak, carefully wipe the fluid off the inside of the battery compartment and insert new batteries.
- Remove the batteries from the remote control unit if it will not be in use for long periods.
- Used batteries should be disposed of in accordance with the local regulations regarding battery disposal.
- The remote control unit may function improperly if rechargeable batteries are used.

Operating range of the remote control unit

Point the remote control unit at the remote sensor when operating it.

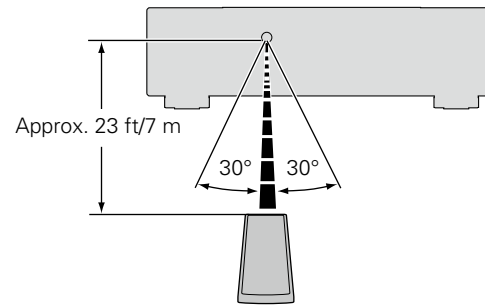

NOTE

- The set may function improperly or the remote control unit may not operate if the remote control sensor is exposed to direct sunlight, strong artificial light from an inverter type fluorescent lamp or infrared light.
- When using 3D video devices that transmit radio communication signals (such as infrared signals etc) between the various units (such as the monitor, 3D glasses, 3D transmitter unit etc), the remote control unit may not operate due to interference from those radio communication signals. If this occurs, adjust the direction and distance of the 3D communication for each unit, and check that the remote control unit operation is not affected by these signals.

Other information

- ❑ **Trademark information** (👉 [page 112](#))
- ❑ **Surround** (👉 [page 113](#))
- ❑ **Relationship between video signals and monitor output** (👉 [page 116](#))
- ❑ **Explanation of terms** (👉 [page 117](#))

Trademark information

This product uses the following technologies (Random order):



Manufactured under license from Audyssey Laboratories™. U.S. and foreign patents pending. Audyssey MultEQ®, Audyssey Dynamic EQ® and Audyssey Dynamic Volume® are registered trademarks of Audyssey Laboratories.



Manufactured under license from Dolby Laboratories. “Dolby”, “Pro Logic” and the double-D symbol are trademarks of Dolby Laboratories.



Manufactured under license under U.S. Patent Nos: 5,956,674; 5,974,380; 6,226,616; 6,487,535; 7,212,872; 7,333,929; 7,392,195; 7,272,567 & other U.S. and worldwide patents issued & pending. DTS-HD, the Symbol, & DTS-HD and the Symbol together are registered trademarks of DTS, Inc. Product includes software. © DTS, Inc. All Rights Reserved.



HDMI, the HDMI Logo and High-Definition Multimedia Interface are trademarks or registered trademarks of HDMI Licensing LLC in the United States and other countries.



“Made for iPod” and “Made for iPhone” mean that an electronic accessory has been designed to connect specifically to iPod, or iPhone, respectively, and has been certified by the developer to meet Apple performance standards.

Apple is not responsible for the operation of this device or its compliance with safety and regulatory standards. Please note that the use of this accessory with iPod, or iPhone, may affect wireless performance.

AirPlay, the AirPlay logo, iPad, iPhone, iPod, iPod classic, iPod nano, iPod shuffle and iPod touch are trademarks of Apple Inc., registered in the U.S. and other countries.

- Individual users are permitted to use iPhone, iPod, iPod classic, iPod nano, iPod shuffle, and iPod touch for private copy and playback of non-copyrighted contents and contents whose copy and playback is permitted by law. Copyright infringement is prohibited by law.



Windows Media and the Windows logo are trademarks or registered trademarks of Microsoft Corporation in the United States and/or other countries.

Surround

This unit is equipped with a digital signal processing circuit that lets you play program sources in the sound mode to achieve the same sense of presence as in a movie theater.

Sound modes and surround parameters

This table shows the speakers that can be used in each sound mode and the surround parameters adjustable in each sound mode.

Symbols in the table

- This indicates the audio output channels or surround parameters that can be set.
- ⊙ This indicates the audio output channels. The output channels depend on the settings of "Speaker Config." (page 94).

Sound Mode (page 64)	Channel output				Surr.Parameter (page 81)						
	Front L/R	Center	Surround L/R	Subwoofer	Cinema EQ (page 81)	Loudness Mngmt *1 (page 81)	Dynamic Comp. *2 (page 81)	Low Frequency *3 (page 81)	Delay Time (page 82)	Effect Level (page 82)	Room Size (page 82)
DIRECT (2channel)	○			⊙*4		○	○				
DIRECT (Multi-channel)	○	⊙	⊙	⊙		○	○	○			
STEREO	○			⊙		○	○	○			
MULTI CH IN	○	⊙	⊙	⊙				○			
DOLBY PRO LOGIC II	○	⊙	⊙	⊙	○*5	○	○				
DOLBY PRO LOGIC	○	⊙	⊙	⊙	○	○	○				
DOLBY DIGITAL	○	⊙	⊙	⊙				○			
DOLBY DIGITAL Plus	○	⊙	⊙	⊙				○			
DOLBY TrueHD	○	⊙	⊙	⊙		○	○	○			
DTS NEO:6	○	⊙	⊙	⊙	○*6	○	○				
DTS SURROUND	○	⊙	⊙	⊙				○			
DTS 96/24	○	⊙	⊙	⊙				○			
DTS-HD	○	⊙	⊙	⊙				○			
DTS Express	○	⊙	⊙	⊙				○			
MULTI CH STEREO	○	⊙	⊙	⊙		○	○	○			
ROCK ARENA	○	⊙	⊙	⊙		○	○	○		○	○
JAZZ CLUB	○	⊙	⊙	⊙		○	○	○		○	○
MONO MOVIE	○	⊙	⊙	⊙		○	○	○		○	○
VIDEO GAME	○	⊙	⊙	⊙		○	○	○		○	○
MATRIX	○	⊙	⊙	⊙		○	○	○	○		
VIRTUAL	○			⊙		○	○	○			

- *1 This item can be selected when a Dolby TrueHD signal is played.
- *2 This item can be selected when a Dolby Digital or DTS signal is played.
- *3 This item can be selected when a Dolby Digital or DTS signal or DVD-Audio is played.
- *4 Only when "Subwoofer Mode" is set to "LFE+Main" (page 94), sound is output from the subwoofer.
- *5 This setting is possible when the sound mode is "PLII Cinema".
- *6 This setting is possible when the sound mode is "DTS NEO:6 Cinema".



Sound Mode (page 64)	Surr.Parameter (page 81)				Tone *7 (page 82)	Audyssey *8 (page 84)			Restorer *10 (page 83)
	PRO LOGIC II Music mode only			NEO:6 Music mode only		MultEQ® *9 (page 84)	Dynamic EQ® *9 (page 84)	Dynamic Volume® *9 (page 84)	
	Panorama (page 81)	Dimension (page 81)	Center Width (page 81)	Center Image (page 81)					
DIRECT (2channel)									
DIRECT (Multi-channel)									
STEREO					○	○	○	○	○
MULTI CH IN					○	○	○	○	
DOLBY PRO LOGIC II	○	○	○		○	○	○	○	○
DOLBY PRO LOGIC	○	○	○		○	○	○	○	○
DOLBY DIGITAL					○	○	○	○	
DOLBY DIGITAL Plus					○	○	○	○	
DOLBY TrueHD					○	○	○	○	
DTS NEO:6				○	○	○	○	○	○
DTS SURROUND					○	○	○	○	
DTS 96/24					○	○	○	○	
DTS-HD					○	○	○	○	
DTS Express					○	○	○	○	
MULTI CH STEREO					○	○	○	○	○
ROCK ARENA					○*11	○	○	○	○
JAZZ CLUB					○	○	○	○	○
MONO MOVIE					○	○	○	○	○
VIDEO GAME					○	○	○	○	○
MATRIX					○	○	○	○	○
VIRTUAL					○	○	○	○	○

*7 This item cannot be set when "Dynamic EQ®" (page 84) is set to "On".

*8 For HD Audio whose sampling frequency of an input signal is more than 96 kHz, this sound parameter cannot be set.

*9 This item cannot be set when "MultEQ®" (page 84) is set to "Off" or "Manual EQ".

*10 This item can be set when the input signal is analog, PCM 48 kHz or 44.1 kHz.

*11 In this sound mode, bass is +6 dB, and treble is +4 dB (Default).

Types of input signals, and corresponding sound modes

This table shows the input signal that can be played in each sound mode. Check the audio signal of the input source then select the sound mode.

Symbols in the table

- This indicates the default sound mode.
- This indicates the selectable sound mode.

Sound Mode (see page 64)	NOTE	Input signal types and formats															
		ANALOG	PCM		DTS-HD		DTS					DOLBY		DOLBY DIGITAL			
			PCM (multi ch)	PCM (2ch)	DTS-HD Master Audio	DTS-HD High Resolution Audio	DTS EXPRESS	DTS ES DSCRT (With Flag)	DTS ES MTRX (With Flag)	DTS (5.1ch)	DTS 96/24	DOLBY TrueHD	DOLBY DIGITAL Plus	DOLBY DIGITAL EX (With Flag)	DOLBY DIGITAL EX (With no Flag)	DOLBY DIGITAL (5.1/5/4/3ch)	DOLBY DIGITAL (2ch)
DTS SURROUND																	
DTS-HD MSTR					●												
DTS-HD HI RES						●											
DTS SURROUND																	
DTS 96/24																	
DTS EXPRESS																	
DTS NEO:6 CINEMA		○		○													○
DTS NEO:6 MUSIC		○		○													○
DOLBY SURROUND																	
DOLBY TrueHD																	
DOLBY DIGITAL+																	
DOLBY DIGITAL																	
DOLBY PRO LOGIC II CINEMA		○		○													
DOLBY PRO LOGIC II MUSIC		○		○													
DOLBY PRO LOGIC II GAME		○		○													
DOLBY PRO LOGIC		○		○													
MULTI CH IN																	
MULTI CH IN																	
DIRECT																	
DIRECT		○	○	○	○	○	○	○	○	○	○	○	○	○	○	○	○
DSP SIMULATION																	
MULTI CH STEREO		○	○	○	○	○	○	○	○	○	○	○	○	○	○	○	○
ROCK ARENA		○	○	○	○	○	○	○	○	○	○	○	○	○	○	○	○
JAZZ CLUB		○	○	○	○	○	○	○	○	○	○	○	○	○	○	○	○
MONO MOVIE		○	○	○	○	○	○	○	○	○	○	○	○	○	○	○	○
VIDEO GAME		○	○	○	○	○	○	○	○	○	○	○	○	○	○	○	○
MATRIX		○	○	○	○	○	○	○	○	○	○	○	○	○	○	○	○
VIRTUAL		○	○	○	○	○	○	○	○	○	○	○	○	○	○	○	○
STEREO																	
STEREO		●	○	●	○	○	○	○	○	○	○	○	○	○	○	○	○



Relationship between video signals and monitor output

Input		Output		HDMI output		Video output	
		HDMI	VIDEO	Video	Menu	Video	Menu
×	×	×	Only the menu is displayed	○ <HDMI>	○ (HDMI)	×	×
×	○					○ <VIDEO>	
○	×	×					
○	○	○ <VIDEO>					

○ : Video signal input present

×

○ <> : The input signal between the < > marks is output.

×

○ () : Superimposed on the picture indicated in ().

×

NOTE

- If you operate the menu while playing back 3D video content or computer's resolution (e.g. VGA), the playback video is replaced by the menu screen. The playback video is not displayed behind the menu screen.
- This unit does not show the status display while playing back 3D video content or computer's resolution (e.g. VGA).
- The network menu is only output to TVs that support HDMI.

Explanation of terms

A

Adobe RGB color, Adobe YCC601 color

The color space defined by Adobe Systems Inc. Because it is a wider color space than RGB, it can produce more vivid and natural images.

AirPlay

AirPlay sends (plays) contents recorded in iTunes or on an iPhone/iPod touch/iPad to a compatible device via the network.

App Store

App Store is a site that sells application software for such devices as the iPhone or iPod Touch, and is operated by Apple Inc.

Audyssey Dynamic EQ®

Dynamic EQ® solves the problem of deteriorating sound quality as volume is decreased by taking into account human perception and room acoustics. Audyssey Dynamic EQ® works in tandem with Audyssey MultEQ® to provide well-balanced sound for every listener at any volume level.

Audyssey Dynamic Volume®

Dynamic Volume® solves the problem of large variations in volume level between television programs, commercials, and between the soft and loud passages of movies. Audyssey Dynamic EQ® is integrated into Dynamic Volume® so that as the playback volume is adjusted automatically, the perceived bass response, tonal balance, surround impression, and dialog clarity remain the same.

Audyssey MultEQ®

MultEQ® is a room equalization solution that calibrates any audio system so that it can achieve optimum performance for every listener in a large listening area. Based on several room measurements, MultEQ® calculates an equalization solution that corrects for both time and frequency response problems in the listening area and also performs a fully automated surround system setup.

Auto Lip Sync

If you connect the unit to a TV that supports the Auto Lip Sync function, it can automatically correct delay between the audio and video.

D

Deep Color

An imaging technology supported by HDMI. Unlike RGB, which uses 8 bits (256 shades) per color, it can use 10 bits (1024 shades), 12 bits (4096 shades), or 16 bits (65536 shades) to produce colors in higher definition.

Both devices linked via HDMI must support Deep Color.

DLNA

DLNA and DLNA CERTIFIED are trademarks and/or service marks of Digital Living Network Alliance. Some contents may not be compatible with other DLNA CERTIFIED™ products.

Dolby Digital

Dolby Digital is a multi-channel digital signal format developed by Dolby Laboratories.

A total of 5.1 channels are played: 3 front channels ("FL", "FR" and "C"), 2 surround channels ("SL" and "SR") and the "LFE" channel for low frequencies.

Because of this, there is no crosstalk between channels and a realistic sound field with a "three-dimensional" feeling (sense of distance, movement and positioning) is achieved.

A realistic, powerful sense of presence is achieved when playing movie sources in AV rooms as well.

Dolby Digital Plus

Dolby Digital Plus is an improved Dolby Digital signal format that is compatible with up to 7.1 channels of discrete digital sound and also improves sound quality thanks to extra data bit rate performance. It is upwardly compatible with conventional Dolby Digital, so it offers greater flexibility in response to the source signal and the conditions of the playback device.

Dolby Pro Logic II

Dolby Pro Logic II is a matrix decoding technology developed by Dolby Laboratories.

Regular music such as that on CDs is encoded into 5 channels to achieve an excellent surround effect. The surround channel signals are converted into stereo and full band signals (with a frequency response of 20 Hz to 20 kHz or greater) to create a "three-dimensional" sound image offering a rich sense of presence for all stereo sources.

Dolby TrueHD

Dolby TrueHD is a high definition audio technology developed by Dolby Laboratories, using lossless coding technology to faithfully reproduce the sound of the studio master.

This format provides the facility to support up to 8 audio channels with a sampling frequency of 96 kHz/24 bit resolution and up to 6 audio channels with a sampling frequency of 192 kHz/24 bit resolution. Dolby TrueHD is adopted for applications that put very high importance on sound quality.

Downmix

This function converts the number of channels of surround audio to less number of channels and plays back.

DTS

This is an abbreviation of Digital Theater System, which is a digital audio system developed by DTS. When playing back audio by connecting this system with a device such as DTS amplifier, accurate sound field position and realistic sound effect as if you are in a movie theater can be obtained.

DTS 96/24

DTS 96/24 is a digital audio format enabling high sound quality playback in 5.1 channels with a sampling frequency of 96 kHz and 24 bit quantization on DVD-Video.

DTS Digital Surround

DTS Digital Surround is the standard digital surround format of DTS, Inc., compatible with a sampling frequency of 44.1 or 48 kHz and up to 5.1 channels of digital discrete surround sound.

DTS Express

DTS Express is an audio format supporting low bit rates (max. 5.1 channels, 24 to 256 kbps).

DTS-HD

This audio technology provides higher sound quality and enhanced functionality than the conventional DTS and is adopted as an optional audio for Blu-ray Disc. This technology supports multi-channel, high data transfer speed, high sampling frequency, and lossless audio playback. Maximum 7.1-channels are supported in Blu-ray Disc.

DTS-HD High Resolution Audio

DTS-HD High Resolution Audio is an improved version of the conventional DTS, DTS-ES and DTS 96/24 signals formats, compatible with sampling frequencies of 96 or 48 kHz and up to 7.1 channels of discrete digital sound. High data bit rate performance provides high quality sound. This format is fully compatible with conventional products, including conventional DTS digital surround 5.1-channel data.

DTS-HD Master Audio

DTS-HD Master Audio is a lossless audio format created by Digital Theater System (DTS). This format provides the facility to support up to 8 audio channels with a sampling frequency of 96 kHz/24 bit resolution and up to 6 audio channels with a sampling frequency of 192 kHz/24 bit resolution. It is fully compatible with conventional products, including conventional DTS digital surround 5.1-channel data.

DTS NEO:6™ Surround

DTS NEO:6™ is a matrix decoding technology for achieving 6.1-channel surround playback with 2-channel sources. It includes "DTS NEO:6 Cinema" suited for playing movies and "DTS NEO:6 Music" suited for playing music.

Dynamic range

The difference between the maximum undistorted sound level and the minimum discernible level above the noise emitted by the device.

F

FLAC

FLAC stands for Free lossless Audio Codec, and is a lossless free audio file format. Lossless means that the audio is compressed without any loss in quality. The FLAC license is as shown below.

Copyright (C) 2000,2001,2002,2003,2004,2005,2006,2007,2008,2009 Josh Coalson

Redistribution and use in source and binary forms, with or without modification, are permitted provided that the following conditions are met:

- Redistributions of source code must retain the above copyright notice, this list of conditions and the following disclaimer.
- Redistributions in binary form must reproduce the above copyright notice, this list of conditions and the following disclaimer in the documentation and/or other materials provided with the distribution.
- Neither the name of the Xiph.org Foundation nor the names of its contributors may be used to endorse or promote products derived from this software without specific prior written permission. THIS SOFTWARE IS PROVIDED BY THE COPYRIGHT HOLDERS AND CONTRIBUTORS "AS IS" AND ANY EXPRESS OR IMPLIED WARRANTIES, INCLUDING, BUT NOT LIMITED TO, THE IMPLIED WARRANTIES OF MERCHANTABILITY AND FITNESS FOR A PARTICULAR PURPOSE ARE DISCLAIMED. IN NO EVENT SHALL THE FOUNDATION OR CONTRIBUTORS BE LIABLE FOR ANY DIRECT, INDIRECT, INCIDENTAL, SPECIAL, EXEMPLARY, OR CONSEQUENTIAL DAMAGES (INCLUDING, BUT NOT LIMITED TO, PROCUREMENT OF SUBSTITUTE GOODS OR SERVICES; LOSS OF USE, DATA, OR PROFITS; OR BUSINESS INTERRUPTION) HOWEVER CAUSED AND ON ANY THEORY OF LIABILITY, WHETHER IN CONTRACT, STRICT LIABILITY, OR TORT (INCLUDING NEGLIGENCE OR OTHERWISE) ARISING IN ANY WAY OUT OF THE USE OF THIS SOFTWARE, EVEN IF ADVISED OF THE POSSIBILITY OF SUCH DAMAGE.

H

HDCP

When transmitting digital signals between devices, this copyright protection technology encrypts the signals to prevent content from being copied without authorization.

HDMI

This is an abbreviation of High-Definition Multimedia Interface, which is an AV digital interface that can be connected to a TV or amplifier. Video signal and audio signal can be connected using 1 cable.

I

iTunes

iTunes is the name of the multimedia player provided by Apple Inc. It enables management and playback of multimedia contents including music and movies. iTunes supports many main file formats including AAC, WAV, and MP3.

L

LFE

This is an abbreviation of Low Frequency Effect, which is an output channel that emphasizes low frequency effect sound. Surround audio is intensified by outputting 20 Hz to 120 Hz deep bass.

M

MP3 (MPEG Audio Layer-3)

This is an internationally standardized audio data compression scheme, using the "MPEG-1" video compression standard. It compresses the data volume to about one eleventh its original size while maintaining sound quality equivalent to a music CD.

MPEG (Moving Picture Experts Group), MPEG-2, MPEG-4

These are the names for digital compression format standards used for the encoding of video and audio. Video standards include "MPEG-1 Video", "MPEG-2 Video", "MPEG-4 Visual", "MPEG-4 AVC". Audio standards include "MPEG-1 Audio", "MPEG-2 Audio", "MPEG-4 AAC".

P

Progressive (sequential scanning)

This is a scanning system of video signal that displays 1 frame of video as one image. Compared to the interlace system, this system provides images with less flickering and bleeding.

Protection circuit

This is a function to prevent damage to devices within the power supply when an abnormality such as an overload, excess voltage occurs or temperature for any reason.

In this unit, the power indicator blinks and the unit enters standby mode when an abnormality occurs.

S

Sampling frequency

Sampling involves taking a reading of a sound wave (analog signal) at regular intervals and expressing the height of the wave at each reading in digitized format (producing a digital signal).

The number of readings taken in one second is called the "sampling frequency". The larger the value, the closer the reproduced sound is to the original.

Speaker impedance

This is an AC resistance value, indicated in Ω (ohms). Greater power can be obtained with this value smaller.

sYCC601 color

Like "x.v.Color", each of these color spaces defines a palette of available colors that is larger than the traditional RGB color model.

V

vTuner

This is a free online content server for Internet radio. Note that usage fees are included in upgrade costs.

For inquiries about this service, visit the vTuner site below.

vTuner website: <http://www.radiodemon.com>

This product is protected by certain intellectual property rights of Nothing Else Matters Software and BridgeCo. Use or distribution of such technology outside of this product is prohibited without a license from Nothing Else Matters Software and BridgeCo or an authorized subsidiary.

W

Windows Media DRM

This is a copyright protection technology developed by Microsoft.

Content providers are using the digital rights management technology for Windows Media contained in this device (WM-DRM) to protect the integrity of their content (Secure Content) so that their intellectual property, including copyright, in such content is not misappropriated. This device uses WM-DRM software to play Secure Content (WM-DRM Software). If the security of the WM-DRM Software in this device has been compromised, owners of Secure Content (Secure Content Owners) may request that Microsoft revoke the WM-DRM Software's right to acquire new licenses to copy, display and/or play Secure Content. Revocation does not alter the WM-DRM Software's ability to play unprotected content. A list of revoked WM-DRM Software is sent to your device whenever you download a license for Secure Content from the Internet or from a PC. Microsoft may, in conjunction with such license, also download revocation list onto your device on behalf of Secure Content Owners.

Windows Media Player Ver.11 or later

This is a media player distributed free of charge by Microsoft Corporation.

It can play playlists created with Ver.11 or later of Windows Media Player, as well as WMA, DRM WMA, WAV, and other files.

WMA (Windows Media Audio)

This is audio compression technology developed by Microsoft Corporation.

WMA data can be encoded using Windows Media® Player Ver.7, 7.1, Windows Media® Player for Windows® XP and Windows Media® Player 9 Series.

To encode WMA files, only use applications authorized by Microsoft Corporation. If you use an unauthorized application, the file may not work properly.

X

x.v.Color

This function lets HDTVs display colors more accurately. It enables display with natural, vivid colors. "x.v.Color" is a Sony registered trademark.

Troubleshooting

If a problem should arise, first check the following:

1. Are the connections correct?

2. Is the set being operated as described in the owner's manual?

3. Are the other devices operating properly?

If this unit does not operate properly, check the items listed in the table below. Should the problem persist, there may be a malfunction.

In this case, disconnect the power immediately and contact your store of purchase.

[General]

Symptom	Cause/Solution	Page
Power does not turn on.	<ul style="list-style-type: none"> Check whether the power plug is correctly inserted into the power outlet. The protection circuit is active. Disconnect the power plug from the electric outlet, wait 5 to 10 seconds and then insert it back into the outlet. 	27 118
Power automatically switches to standby mode.	<ul style="list-style-type: none"> The sleep timer is set. Turn on the power again, or change the sleep timer settings. "Auto Standby" is triggered when there is no operation for a set amount of time. To disable "Auto Standby", set "Auto Standby" on the menu to "Off". 	74 102
Display is off.	<ul style="list-style-type: none"> Set "Dimmer" on the menu to something other than "Off". 	102
The power indicator is blinking red in intervals of approximately 2 seconds.	<ul style="list-style-type: none"> The protection circuit has been activated by a rise in the humidity inside the unit. Please turn off power once, and re-apply the power after the temperature has fallen sufficiently. Please re-install this unit in a place having good ventilation. 	– –
The power indicator is blinking red in intervals of approximately 0.5 seconds.	<ul style="list-style-type: none"> Please use speakers which have the specified impedance. The protection circuit has been activated because the speaker cable core wires are touching, a core wire has come loose from the terminal, or a core wire is touching the rear panel of this unit. After unplugging the power cord, take corrective action such as firmly re-twisting the core wire or taking care of the terminal, and then reconnect the wire. 	70 70
After turning on the power, the power indicator is blinking red in intervals of approximately 0.5 seconds.	<ul style="list-style-type: none"> This unit amplifier circuit has failed. Turn off the power and please contact the DENON service adviser. 	–
Set does not operate properly.	<ul style="list-style-type: none"> Reset the microprocessor. 	123

[HDMI]

Symptom	Cause/Solution	Page
No audio is output with HDMI connection.	<ul style="list-style-type: none"> Check the connection of the HDMI connectors. When outputting HDMI audio from the speakers, set "HDMI Audio Out" on the menu to "AVR". When outputting HDMI audio from a TV, set "HDMI Audio Out" on the menu to "TV". 	10 87 87
No video is output with HDMI connection.	<ul style="list-style-type: none"> Check the connection of the HDMI connectors. Set the input source to match the connected HDMI connector. Check whether the TV is compatible with copyright protection (HDCP). If connected to a device not compatible with HDCP, video will not be output correctly. 	10 10, 27 11
When the following operations are performed on devices compatible with HDMI control, the same operations occur on this unit. <ul style="list-style-type: none"> Power ON/OFF Switching audio output devices Adjust volume Switch input source 	<ul style="list-style-type: none"> Set "HDMI Control" in the menu to "Off". <p>Furthermore, if you do not want to link the power off operation with devices compatible with HDMI control, set "P.Off Control" in the menu to "Off".</p>	73, 87

[Video]

Symptom	Cause/Solution	Page
No picture appears.	<ul style="list-style-type: none"> Check the connection between the video output terminal of this unit and the input terminal of the TV. Match the input settings to the input terminal of the TV connected to this unit. 	9, 13 –

[Audio]

Symptom	Cause/Solution	Page
Audio is not output.	<ul style="list-style-type: none"> • Check the connections for all devices. • Check the speaker connections and configurations. • Check whether the audio device power is turned on. • Adjust the master volume. • Cancel the mute mode. • Check the connection with the playback device and select the proper input source. • Match the input mode and the terminal assigned to be the digital input terminal. • Disconnect the headphones. No sound is output from the speakers when headphones are connected. 	9 , 10 , 13 , 14 , 15 , 16 , 17 , 18 71 , 72 – 28 28 27 91 107
The volume does not increase.	<ul style="list-style-type: none"> • The maximum volume is set too low. Set the maximum volume using "Limit" on the menu. • Power for external devices connected to the output connectors of the unit may not be turned on. Check the power of connected external devices. 	83 –
No sound is produced from surround speaker.	<ul style="list-style-type: none"> • Check if the surround speakers are connected to the SURROUND terminals. 	–
No sound is produced from subwoofer.	<ul style="list-style-type: none"> • Check the subwoofer connections. • Turn on the subwoofer's power. • Set "Speaker Config." – "Subwoofer" on the menu to "Yes". • If "Front" and "Center" for "Speaker Config." are set to "Large", and "Subwoofer Mode" is set to "LFE", no sound may be output from the subwoofers, depending on the input signal or selected sound mode. 	71 , 72 – 94 94
DTS sound is not output.	<ul style="list-style-type: none"> • Set "Decode Mode" on the menu to "Auto" or "DTS". 	92
Dolby TrueHD, DTS-HD, Dolby Digital Plus audio is not output.	<ul style="list-style-type: none"> • Make HDMI connections. 	10

Symptom	Cause/Solution	Page
Dolby PLII mode or DTS NEO:6 mode cannot be selected.	<ul style="list-style-type: none"> • Check that "Speaker Config." – "Center" or "Surround" is set to other than "None". If the speaker system is 2.0/2.1ch, this sound mode cannot be selected. • When headphones are used, Dolby PLII or DTS NEO:6 cannot be selected. 	94 –
Audyssey MultEQ®, Audyssey Dynamic EQ® and Audyssey Dynamic Volume® cannot be selected.	<ul style="list-style-type: none"> • Switch the sound mode to other than "DIRECT". • When headphones are used, Audyssey MultEQ®, Audyssey Dynamic EQ® and Audyssey Dynamic Volume® cannot be selected. 	64 –
Dynamic EQ® and Dynamic Volume® cannot be selected.	<ul style="list-style-type: none"> • Run Audyssey® Setup. 	20
"Restorer" cannot be selected.	<ul style="list-style-type: none"> • Check that an analog signal or PCM signal (Sample rate=44.1/48 kHz) is input. For playback of multichannel signals such as Dolby Digital or DTS surround, "Restorer" cannot be used. • Switch the sound mode to other than "DIRECT". 	83 64

[FM]

Symptom	Cause/Solution	Page
Reception fails, or there is a lot of noise or distortion.	<ul style="list-style-type: none"> • Change the antenna orientation or position. • Use an FM outdoor antenna. • Separate the antenna from other connection cables. 	17 17 17



[iPod / USB memory device / Internet radio / Media server / Flickr / Pandora / SiriusXM]



Symptom	Cause/Solution	Page
iPod cannot be played.	<ul style="list-style-type: none"> Some iPods do not support being used connected directly to the iPod/USB port. 	16
The file names are not displayed properly ("...", etc.).	<ul style="list-style-type: none"> Characters that cannot be displayed are used. This is not a malfunction. On this unit, characters that cannot be displayed are replaced with a "." (period). The USB cable connecting the USB memory device and the unit uses incompatible tags. Use USB memory devices with tags supported by the unit. 	– 32
When a USB memory device is connected, "USB" is not displayed on the menu.	<ul style="list-style-type: none"> The set cannot recognize a USB memory device. Check the connection. This unit supports mass storage class and MTP-compatible USB memory devices. It will not recognize other USB memory devices. A USB memory device that the set cannot recognize is connected. This is not a malfunction. DENON does not guarantee that all USB memory devices will operate or receive power. USB memory device is connected via USB hub. Connect the USB memory device directly to the iPod/USB port. The unit supports file structures with up to 8 levels and a total maximum of 5000 subfolders and files per 1 folder. Change the file structure of the USB memory device if necessary. 	16 – – 32
Files on a USB memory device cannot be played.	<ul style="list-style-type: none"> The USB memory device format should be set to FAT16 or FAT32. For details, refer to the USB memory device's operating instructions. If the USB memory device is divided into multiple partitions, only files in partition one can be played. Files are stored in a non-compatible format. Record the files in a compatible format. You are attempting to play a file that is copyright protected. Files that are copyright protected cannot be played on this unit. 	– – 32 32
Internet radio cannot be played.	<ul style="list-style-type: none"> Ethernet cable is not properly connected or network is disconnected. Check the connection status. Program is being broadcast in non-compatible format. Only Internet radio programs in MP3 and WMA can be played on this unit. The firewall of the PC or router has been activated. Check the firewall settings of the connected PC or router. Radio station is not currently broadcasting. Choose a radio station that is currently broadcasting. IP address is wrong. Check the set's IP address. Some radio stations may go silent at certain times of the day. In this case, no audio is output even when a station is received. Try again later, or switch to another radio station. 	18 43 – 43 98 –

Symptom	Cause/Solution	Page
Files stored on a computer cannot be played.	<ul style="list-style-type: none"> Files are stored in a non-compatible format. Record in a compatible format. You are attempting to play a file that is copyright protected. Files that are copyright protected cannot be played on this unit. Set and computer are connected by USB cable. The set's iPod/USB port cannot be used for connection to a computer. Media sharing settings are not correct. Change media sharing settings so that the unit can access the folders on your computer. 	46 46 – 47
Music stored on a NAS cannot be played.	<ul style="list-style-type: none"> If you use a NAS in conformity with the DLNA standard, enable the DLNA server function in the NAS setting. If you use a NAS that does not conform with the DLNA standard, play the music via a PC. Set Windows Media Player's media sharing function and add NAS to the selected play folder. If connection is restricted, set audio equipment as the connection target. 	– 47 –
Server is not found, or it is not possible to connect to the server.	<ul style="list-style-type: none"> The computer's or router's firewall is activated. Check the computer's or router's firewall settings. Computer's power is not turned on. Turn on the power. Server is not running. Launch the server. Set's IP address is wrong. Check the set's IP address. 	– – – 98
Cannot connect to preset or favorite radio stations.	<ul style="list-style-type: none"> Radio station is not currently broadcasting. Wait a while before trying again. Radio station is not currently in service. It is not possible to connect to radio stations that are no longer in service. 	– –
A list of broadcasting stations is not displayed.	<ul style="list-style-type: none"> Connection to the network is unstable. Reconnect to the network or redo the "Network" setting in the menu. 	18 , 99
For some radio stations, "Radio station server full" or "Connection down" is displayed and station cannot be connected to.	<ul style="list-style-type: none"> Station is congested or not currently broadcasting. Wait a while before trying again. 	–
Sound is broken during playback.	<ul style="list-style-type: none"> Network or USB memory device's signal transfer speed is slow or communications lines or radio station is congested. This is not a malfunction. When playing broadcast data with a high bit rate, the sound may be broken, depending on the communications conditions. 	–

 [See overleaf](#)

Symptom	Cause/Solution	Page
Sound quality is poor or noise is heard during play.	<ul style="list-style-type: none"> File being played has a low bit rate. This is not a malfunction. 	–
Cannot login to Pandora. (“Email address” or “Password” is displayed.)	<ul style="list-style-type: none"> Login information is incorrect. Check if the “Email address” for Pandora has been properly entered. Re-enter the “Password”. (Password is not displayed.) http://www.pandora.com/denon 	53

[AirPlay]

Symptom	Cause/Solution	Page
The AirPlay icon  is not displayed in iTunes or on the iPhone/iPod touch/iPad.	<ul style="list-style-type: none"> This unit and the computer or iPhone/iPod touch/iPad are not connected to the same network (LAN). Connect the computer or iPhone/iPod touch/iPad to the same network as this unit. iTunes or the iPhone/iPod touch/iPad do not have firmware that supports AirPlay installed. Update to the latest firmware. 	18 104
No sound.	<ul style="list-style-type: none"> The volume in iTunes or on the iPhone/iPod touch/iPad is set to the minimum setting. Adjust the volume to the optimum level. This unit is not selected in the screen that is displayed when iTunes or the iPhone/iPod touch/iPad is started. Start iTunes or switch on the iPhone/iPod touch/iPad, click the AirPlay icon  in the displayed screen, and select this unit. AirPlay playback has not started. Click the ► button in iTunes or press the ► button on the iPhone/iPod touch/iPod. 	– 62 –
When using AirPlay with the iPhone/iPod touch, the sound suffers from intermittent breaks or AirPlay does not function.	<ul style="list-style-type: none"> Quit the application running in the background of the iPhone/iPod touch, and then play using AirPlay. When playing via a wireless connection, outside conditions may affect the unit. To remedy this, change the network environment, e.g. shorten the distance to the wireless LAN access point. Update the iPhone/iPod touch application or iTunes to the latest version. 	– – –

[Remote control unit]

Symptom	Cause/Solution	Page
The set cannot be operated with the remote control unit.	<ul style="list-style-type: none"> Batteries are worn out. Replace with new batteries. Operate the remote control unit within a distance of about 23 ft/7 m from this unit and at an angle of within 30°. Remove any obstacle between this unit and the remote control unit. Insert the batteries in the proper direction, checking the ⊕ and ⊖ marks. The set’s remote control sensor is exposed to strong light (direct sunlight, inverter type fluorescent bulb light, etc.). Move the set to a place in which the remote control sensor will not be exposed to strong light. 	111 111 111 111 111

Resetting the microprocessor

Perform this procedure if the display is abnormal or if operations cannot be performed. When the microprocessor is reset, all the settings are reset to their default values.

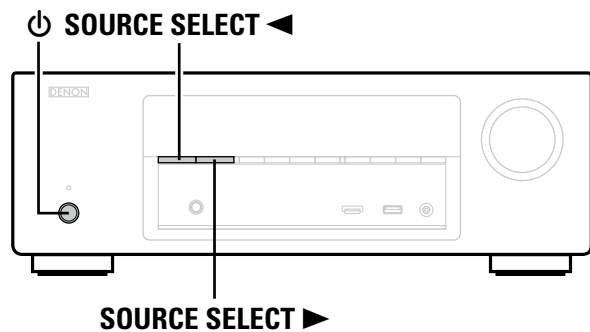

- 1** Turn off the power using **⏻**.
- 2** Press **⏻** while simultaneously pressing **SOURCE SELECT ◀** and **SOURCE SELECT ▶**.
- 3** Once the display starts flashing at intervals of about 1 second, release the two buttons.



If in step 3 the display does not flash at intervals of about 1 second, start over from step 1.

Specifications

□ Audio section

• Power amplifier

Rated output:

Front:
75 W + 75 W (8 Ω, 20 Hz – 20 kHz with 0.08 % T.H.D.)
120 W + 120 W (6 Ω, 1 kHz with 0.7 % T.H.D.)

Center:

75 W (8 Ω, 20 Hz – 20 kHz with 0.08 % T.H.D.)
120 W (6 Ω, 1 kHz with 0.7 % T.H.D.)

Surround:

75 W + 75 W (8 Ω, 20 Hz – 20 kHz with 0.08 % T.H.D.)
120 W + 120 W (6 Ω, 1 kHz with 0.7 % T.H.D.)

6 – 16 Ω

Output connectors:

• Analog

Input sensitivity/Input impedance:

200 mV/47 kΩ

Frequency response:

10 Hz – 100 kHz — +1, –3 dB (DIRECT mode)

S/N:

98 dB (IHF–A weighted, DIRECT mode)

□ Video section

• Standard video connectors

Input/output level and impedance:

1 Vp-p, 75 Ω

Frequency response:

5 Hz – 10 MHz — 0, –3 dB

□ Tuner section

[FM]

(Note: μV at 75 Ω, 0 dBf = 1×10^{-15} W)

87.5 MHz – 107.9 MHz

Receiving Range:

Usable Sensitivity:

1.2 μV (12.8 dBf)

50 dB Quieting Sensitivity:

MONO 2.8 μV (20.2 dBf)

S/N :

MONO 70 dB (IHF–A weighted, DIRECT mode)

STEREO 67 dB (IHF–A weighted, DIRECT mode)

Total harmonic Distortion:

MONO 0.7 % (1 kHz)

STEREO 1.0 % (1 kHz)

□ General

Power supply:

AC 120 V, 60 Hz

Power consumption:

360 W

0.1 W (Standby)

0.5 W (CEC standby)

For purposes of improvement, specifications and design are subject to change without notice.

Index

👉 Numerics	
2.1-channel	72
3D	11
5.1-channel	69, 71
👉 A	
Accessories	2
Add New Feature	105
Adjust EQ	85
Adjusting the master volume	28
Adobe RGB color / Adobe YCC601 color	117
AirPlay	62, 117
App Store	117
ARC	8
Audio	80, 88
Audio Delay	83
Audio Display	88
Audyssey	84
Audyssey Dynamic EQ®	84, 117
Audyssey Dynamic Volume®	84, 117
Audyssey MultEQ®	84, 117
Audyssey® Setup	20
Auto Lip Sync	87, 117
Auto Preset	38
Auto Standby	102
👉 B	
Bass	82, 94
Browse Mode	29, 30
👉 C	
Cable	
Audio cable	12
Coaxial digital cable	12
Ethernet cable	12
HDMI cable	9, 10
Optical cable	12
Speaker cable	71, 72
Subwoofer cable	71, 72
Video cable	12
Center Image	81
Center Width	81
Characters	79
Cinema EQ	81
Condensation	3

Connection	
Blu-ray Disc player	10
Cable TV	14
Digital camcorder	10
DVD player	10, 15
FM	17
Game console	10
HDMI	7
Home network (LAN)	18
iPod (USB)	16
Power cord	19
Satellite tuner	14
Set-top box	10, 14
Speaker	70
TV	9, 13
USB memory device	16
Content Type	11
Crossovers	96
Curve Copy	85
👉 D	
Decode Mode	92
Deep Color	11, 117
Delay Time	82
Dialogue	82
Dialogue Level	82
Digital Assign	90
Dimension	81
Dimmer	102
Direct Tune	37
Display	108
Distances	95
DLNA	117
Dolby	
Dolby Digital	67, 117
Dolby Digital Plus	67, 117
Dolby Pro Logic	67
Dolby Pro Logic II	67, 117
Dolby TrueHD	67, 117
Downmix	117
DTS	117
DTS 96/24	67, 117
DTS Digital Surround	117
DTS Express	67, 117
DTS-HD	67, 117
DTS-HD High Resolution Audio	117
DTS-HD Master Audio	117
DTS NEO:6™ Surround	67, 117
Dynamic Comp	81
Dynamic EQ®	84
Dynamic range	117
Dynamic Volume®	84

👉 E	
Edit Name	98
Effect Level	82
Error messages (Audyssey® Setup)	25
👉 F	
Favorites Memory	60
Firmware	104
FLAC	118
Flickr	50, 51
FM	35
FM indoor antenna	17
Format	88
Friendly Name	98
Front Display	102
Front Panel	107
👉 G	
General	101
👉 H	
HDCP	11, 118
HDMI	7, 11, 118
HDMI Audio Out	87
HDMI Control	73, 87
HDMI Setup	87
Headphones	107
Hide Source	91
👉 I	
Info.Display	88
Information	98, 103
Audio	103
Firmware	103
Status	103
Video	103
Input Mode	91
Inputs	89
Input Select	91
Input signal	115
Inputting characters	79
IP Control	98
iTunes	118
👉 L	
Language	102
Levels	95
LFE	118
Limit	83
Listening mode	64

Listening position	20
Lock	105
Loudness Mngmt	81
Low Frequency	81
👉 M	
Manual EQ	85
Manual Setup	94
Menu map	76
MP3	118
MPEG	118
MultEQ®	84
Mute Level	83
👉 N	
Network	26, 97
Notifications	104
👉 O	
On-Screen Info	88
Operation Mode	30
👉 P	
Pandora	50, 53
Panorama	81
Parameter Check	26
Picture View	61
Playback	
Blu-ray Disc player	28
Direct	64, 67
DVD player	28
FLAC	32, 46
Flickr	51
FM	35
Internet radio	43
iPod (USB)	29
JPEG	32, 46
MP3	32, 43, 46
MPEG-4 AAC	32, 46
NAS	46
Original listening mode	67
Pandora	53
PC	46
SiriusXM	56
STEREO	67
USB memory device	32
WAV	32, 46
WMA	32, 43, 46
P.Off Control	87
Power On Level	83

Basic version
Advanced version
Information



Preset Memory	39
Preset Name	40
Preset Skip	41
Progressive	118
Protection circuit	118

Q

Quick select	75
Quick Sel.Names.....	102

R

Random	31, 59
Rear panel	109
Reference Offset	84
Remote control unit	110
Inserting the batteries.....	111
Remote Mode	29, 30
Remove Favorites	61
Repeat	31, 59
Resetting the microprocessor.....	123
Restorer	83
Room Size	82

S

Sampling frequency	118
Scale.....	83
Selecting the input source	27
Settings	99
Setup Lock	105
SiriusXM	50, 56
Sleep timer.....	74
Slideshow.....	61
Sound Mode.....	64, 113
Source Level	91
Source Rename.....	91
Speaker	
Connect	70
Install	69
Set up	20
Speaker Config.....	94
Speaker impedance.....	70, 118
Speakers	93
Speaker Select	85
Standby Source	87
Subwoofer.....	83
Subwoofer Level	83
Subwoofer setting.....	21
Surr.Parameter	81
sYCC601 color.....	118

T

Text Search	58
Tone	82
Tone Control.....	82
Trademark	112
Treble	82
Troubleshooting	119
Tune Mode	36
Turning off the sound temporarily.....	28
Turning the power on.....	27
TV Format.....	88

U

Update.....	104
-------------	-----

V

Video	86
Video Select	92
Video Source	92
Volume	83, 87
Volume Display	87
vTuner	45, 118

W

Windows Media DRM.....	118
Windows Media Player	118
WMA	118

X

x.v.Color	118
-----------------	-----

Dimensions

Unit : in. (mm)

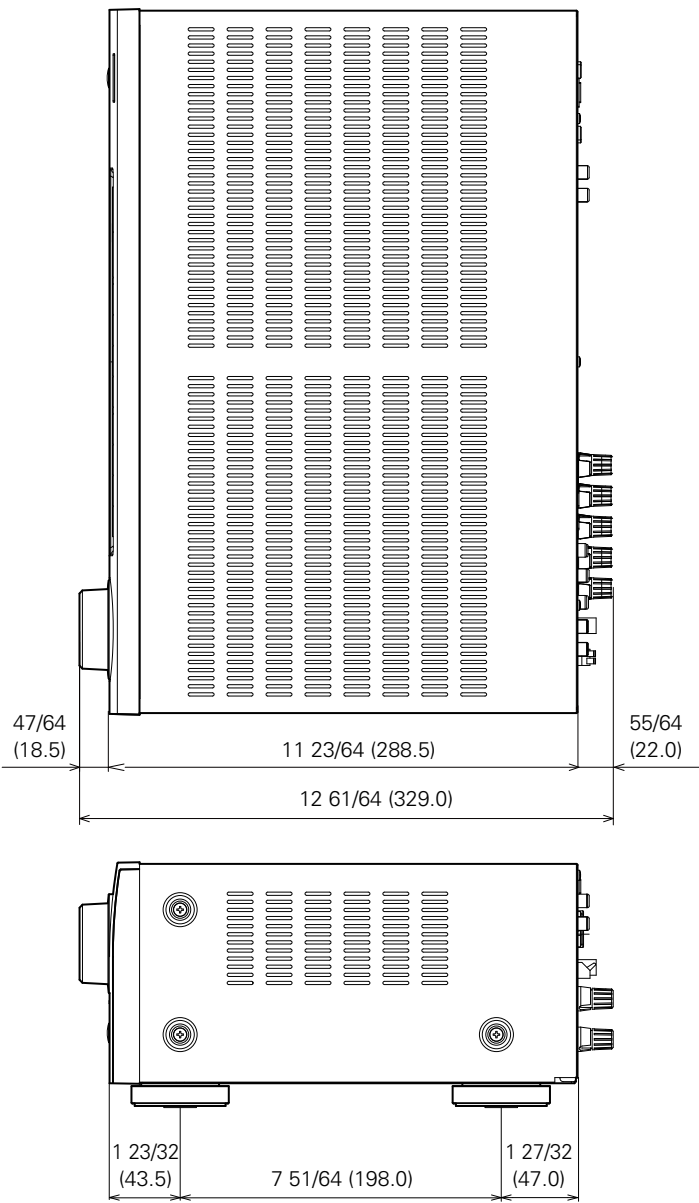

Weight : 18 lbs 1 oz (8.2 kg)

V00

DENON
www.denon.com

D&M Holdings Inc.
3520 10066 00AD

