



Ultra Wash Dishwasher

Use & Care Guide

Lavavajillas Ultra Wash

Manual de uso y cuidado

Lave-vaisselle Ultra Wash

Guide d'utilisation et d'entretien

Models/Modelos/Modèles 665.17799,17792

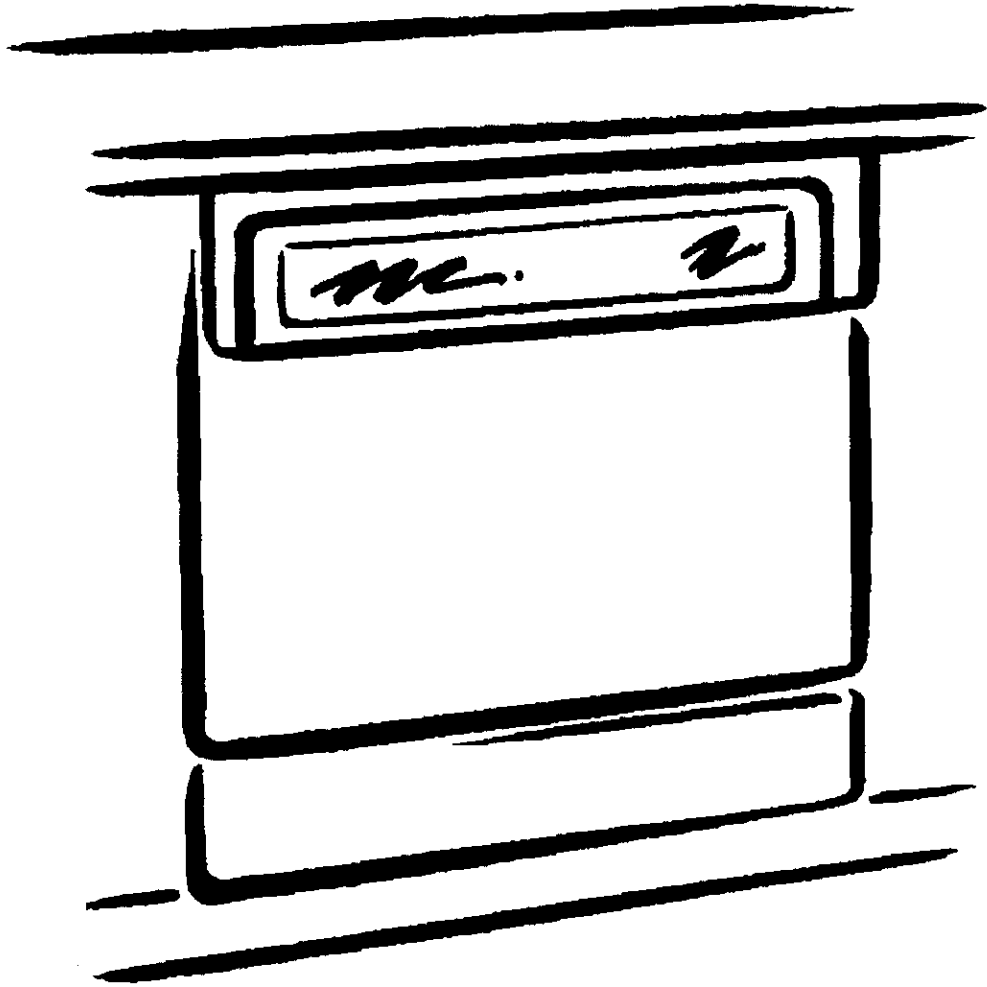

TABLE OF CONTENTS

WE SERVICE WHAT WE SELL	2
WARRANTY	3
DISHWASHER SAFETY	4
PARTS AND FEATURES	6
ULTRA WASH® Soil Removal System	7
START-UP GUIDE	8
Using Your New Dishwasher	8
CONNECTING YOUR DISHWASHER	9
Connecting the Faucet Adapter	9
Connecting to Water and Electrical Supply	9
Using the Faucet	10
Disconnecting the Dishwasher	10
LOADING YOUR DISHWASHER	10
Loading Suggestions	10
Loading the Top Rack	11
Loading the Bottom Rack	11
Loading the Silverware Basket	12
USING YOUR DISHWASHER	13
Detergent Dispenser	13
Rinse Aid Dispenser	14
Dishwasher Efficiency Tips	15
Control Panel	16
Cycle Selection Chart	16
Canceling a Cycle	17
Changing a Cycle or Setting	17
Adding Items During a Cycle	17
Option Selections	17
Cycle Status Indicator	18
Drying System	18
Overfill Protection Float	18
WASHING SPECIAL ITEMS	19
CARING FOR YOUR DISHWASHER	20
Cleaning Your Dishwasher	20
Storing Your Dishwasher	20
TROUBLESHOOTING	21

WE SERVICE WHAT WE SELL

“We Service What We Sell” is our assurance that you can depend on Sears for service. Your dishwasher has added value when you consider that Sears has service units nationwide, staffed with professional technicians specifically trained on Sears appliances and having the parts, tools, and equipment to ensure that we meet our pledge to you...“We Service What We Sell.”

Maintain the value of your KENMORE® Dishwasher with a Sears Maintenance Agreement. Sears dishwashers are designed, manufactured, and tested for years of dependable operation. Yet, any modern appliance may require service from time to time.

The Sears Maintenance Agreement

- Is your way to buy tomorrow's service at today's prices.
- Eliminates repair bills resulting from normal use.
- Allows for as many service calls as required.
- Provides for service by professional Sears Trained Technicians.
- Even if you don't need repairs, the Maintenance Agreement offers an annual preventative maintenance check-up at your request!

This Maintenance Agreement does not cover original installation, reinstallation, or damage resulting from external causes such as acts of abuse, theft, fire, flood, wind, lightning, freezing, power failure, power reduction, etc.

To customize your dishwasher, you can order

- Door and access panel accessories
- Custom wood panel trim accessories to match your dishwasher color

See back page of Installation Instructions that came with your dishwasher for further information.

WARRANTY

FULL ONE-YEAR WARRANTY ON KENMORE ULTRA WASH® DISHWASHERS

For one year from the date of purchase, when this dishwasher is installed and operated according to instructions provided in the Installation Instructions and Use & Care Guide, Sears will repair this dishwasher, free of charge, if defective in material or workmanship.

FULL WARRANTY FOR THE LIFE OF THE DISHWASHER, ON ULTRA LIFE™ TUB MODELS, AGAINST LEAKS IN THE TUB AND INNER DOOR PANEL

For the life of the dishwasher, if a leak should occur as a result of failure of the polypropylene tub or inner door panel due to cracking, chipping or peeling, Sears will replace free of charge the tub or inner door panel.

LIMITED TWO-YEAR WARRANTY ON THE ULTRA WASH WASH SYSTEM

After the first year and until two years from the date of purchase, when the dishwasher is installed and operated in accordance with the instructions provided in the Installation Instructions and Use & Care Guide, Sears will replace any part of the ULTRA WASH wash system (motor, pump, spray arms, ULTRAFLOW™ water feed tube, motor seals and pump gasket) due to defective materials or workmanship. Customer assumes any labor costs associated with replacement of these parts.

If the dishwasher is subject to other than private family use, the above warranty coverage is effective for only 90 days.

WARRANTY SERVICE IS AVAILABLE BY CONTACTING THE NEAREST SEARS SERVICE CENTER IN THE UNITED STATES OR CANADA. This warranty applies only while the product is in use in the United States or Canada. This warranty gives you specific legal rights and you may also have other rights which vary from state to state or province to province.

Warranty terms may vary in Canada.

For Sears Warranty information in the United States or Canada call 1-800-469-4663.

Sears, Roebuck and Co.
D/817WA, Hoffman Estates, IL 60179

Sears Canada, Inc.
Toronto, Ontario, Canada M5B 2B8

In the space below, record your complete model number, serial number, and purchase date. You can find this information on the model and serial number label, located as shown in the Parts and Features section of this book. Have this information available to help you quickly obtain assistance or service when you contact Sears concerning your appliance.

Model number 665. _____
Serial number _____
Purchase date _____

Save these instructions and your sales receipt for future reference.

DISHWASHER SAFETY

Your safety and the safety of others is very important.

We have provided many important safety messages in this manual and on your appliance. Always read and obey all safety messages.



This is the safety alert symbol.

This symbol alerts you to hazards that can kill or hurt you and others.

All safety messages will be preceded by the safety alert symbol and the word "DANGER" or "WARNING." These words mean:

⚠ DANGER

You will be killed or seriously injured if you don't follow instructions.

⚠ WARNING

You can be killed or seriously injured if you don't follow instructions.

All safety messages will identify the hazard, tell you how to reduce the chance of injury, and tell you what can happen if the instructions are not followed.

IMPORTANT SAFETY INSTRUCTIONS

WARNING: When using the dishwasher, follow basic precautions, including the following:

- Read all instructions before using the dishwasher.
- Use the dishwasher only for its intended function.
- Use only detergents or rinse agents recommended for use in a dishwasher, and keep them out of the reach of children.
- When loading items to be washed:
 - 1) Locate sharp items so that they are not likely to damage the door seal; and
 - 2) Load sharp knives with the handles up to reduce the risk of cut-type injuries.
- Do not wash plastic items unless they are marked "dishwasher safe" or the equivalent. For plastic items not so marked, check the manufacturer's recommendations.
- Do not touch the heating element during or immediately after use.
- Do not operate the dishwasher unless all enclosure panels are properly in place.
- Do not tamper with controls.
- Do not abuse, sit on, or stand on the door or dish racks of the dishwasher.
- To reduce the risk of injury, do not allow children to play in or on the dishwasher.
- Under certain conditions, hydrogen gas may be produced in a hot water system that has not been used for two weeks or more. **HYDROGEN GAS IS EXPLOSIVE.** If the hot water system has not been used for such a period, before using the dishwasher turn on all hot water faucets and let the water flow from each for several minutes. This will release any accumulated hydrogen gas. As the gas is flammable, do not smoke or use an open flame during this time.
- Remove the door to the washing compartment when removing an old dishwasher from service or discarding it.

SAVE THESE INSTRUCTIONS

GROUNDING INSTRUCTIONS

■ **For a grounded, cord-connected dishwasher:**

The dishwasher must be grounded. In the event of a malfunction or breakdown, grounding will reduce the risk of electric shock by providing a path of least resistance for electric current. The dishwasher is equipped with a cord having an equipment-grounding conductor and a grounding plug. The plug must be plugged into an appropriate outlet that is installed and grounded in accordance with all local codes and ordinances.

WARNING: Improper connection of the equipment-grounding conductor can result in a risk of electric shock. Check with a qualified electrician or service representative if you are in doubt whether the dishwasher is properly grounded. Do not modify the plug provided with the dishwasher; if it will not fit the outlet, have a proper outlet installed by a qualified electrician.

■ **For a permanently connected dishwasher:**

The dishwasher must be connected to a grounded metal, permanent wiring system, or an equipment-grounding conductor must be run with the circuit conductors and connected to the equipment-grounding terminal or lead on the dishwasher.

SAVE THESE INSTRUCTIONS

ENERGENT

PARTS AND FEATURES

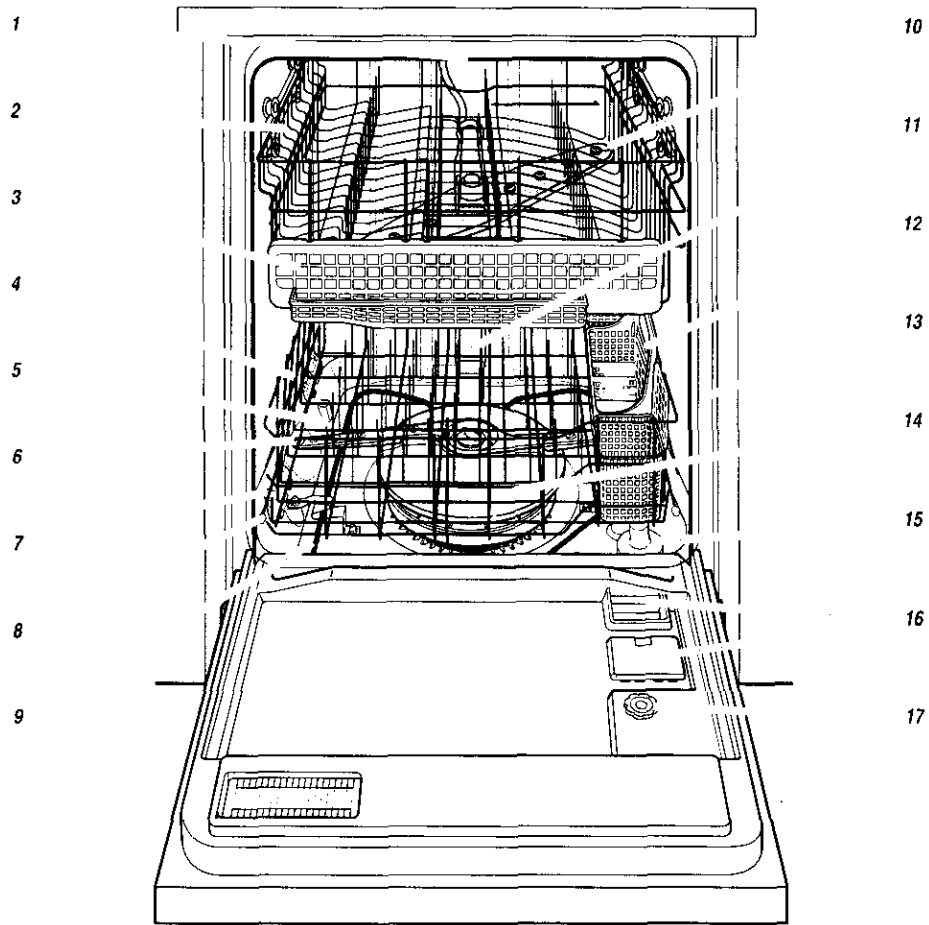

- | | | |
|---------------------|--------------------------------------|--|
| 1. Upper level wash | 7. Water inlet opening [in tub wall] | 13. Model and serial number label |
| 2. Top rack | 8. Rack bumper | 14. ULTRA WASH® module |
| 3. Utensil basket | 9. Heating element | 15. Overfill protection float |
| 4. Bottom rack | 10. Top spray arm | 16. Detergent dispenser |
| 5. Fold-down tines | 11. ULTRA FLOW™ water feed tube | 17. Rinse aid dispenser |
| 6. Lower spray arm | 12. Silverware basket | Other features your dishwasher may have |
| | | NO-FLIP™ clips |

Control Panel



ULTRA WASH Soil Removal System

The ULTRA WASH soil removal system gives you sparkling clean dishes, while using less energy and time. The ULTRA WASH soil removal system includes:

A heavy-duty grinder that acts as a food disposer to grind and dispose of large food particles.

How the ULTRA WASH soil removal system works:

1. Load the dishwasher. Remove bones, large chunks or burned-on food. No rinsing is necessary. Any remaining food soil will be ground up and disposed down the drain with the rinse water.
2. Hot water fills the dishwasher to a level near the bottom of the overfill protection float.
3. The Water Heat indicator glows and the dishwasher pauses while the water is heated.
4. When the water reaches the proper temperature, the Water Heat indicator turns off and the cycle countdown resumes.
5. Detergent from the detergent dispenser is dispensed at the correct cycle times and hot water is pumped through the ULTRA WASH pump.
6. Hot water and detergent sprays against the soiled surfaces of the load and removes food particles.

7. Food soil is held in an accumulating chamber.

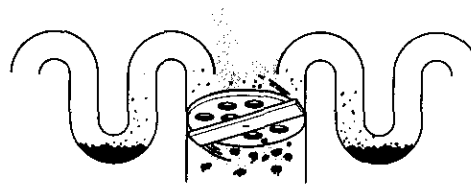

8. Food soil is disposed down the drain with the wash water.

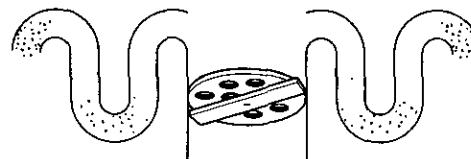

9. Fresh, hot water enters the dishwasher and sprays on the dishes. The rinse water is then pumped through the ULTRA WASH soil removal system and remaining soil is removed.
10. The food soil that is held in the ULTRA WASH soil removal system is disposed down the drain with the rinse water.
11. The final rinse water is heated. The rinse aid is added to the water for the final rinse to prepare the dishes for drying.

START-UP GUIDE

Before using your dishwasher, remove all hang tags, temporary labels, and packaging materials. Read this entire Use and Care Guide. You will find important safety information and useful operating tips.

Using Your New Dishwasher

⚠ WARNING



Electrical Shock Hazard

Plug into a grounded 3 prong outlet.

Do not remove ground prong.

Do not use an adapter.

Do not use an extension cord.

Failure to follow these instructions can result in death, fire, or electrical shock.

A power supply of 120 volts, 60 Hz AC, 15 or 20 amps, is required.

1. Plug into a grounded 3 prong outlet.
2. Scrape large food soil and hard items (toothpicks or bones) from dishes.
3. Properly load the dishwasher. (See "Loading Your Dishwasher.") Make sure nothing prevents the spray arm(s) from spinning freely.

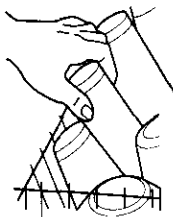

4. Add detergent and check the rinse aid dispenser. Add rinse aid if needed. (See "Using Your Dishwasher.")

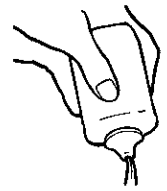
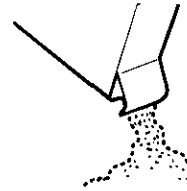

5. Push door firmly closed. The door latches automatically. Run hot water at the sink where you will connect dishwasher until water is hot. (See "Dishwasher Efficiency Tips.") Turn off the water and hook the dishwasher to the faucet. (See "Connecting Your Dishwasher.") Turn on the hot water.

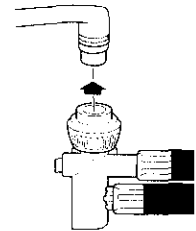
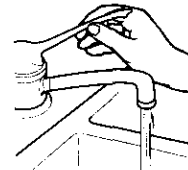

6. Press the desired cycle and option selections. (See "Using Your Dishwasher.") Turn the Cycle Control knob to the desired cycle to start.

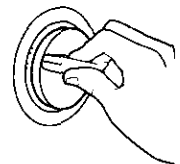
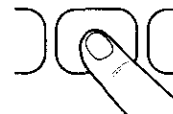

CONNECTING YOUR DISHWASHER

CONNECTING THE FAUCET ADAPTER TO FAUCETS WITH INTERNAL THREADS

NOTE: A special adapter must be installed on the faucet before the dishwasher can be connected. Complete Installation Instructions and the adapter are packed with your dishwasher. See Installation Instructions. When moving your dishwasher make sure the door is latched. Hold the dishwasher at the top front corners.

Preparing the faucet

1. Remove the screen holder or aerator, screen, and washer from the end of the faucet.
2. Use the faucet adapter kit that came with your portable dishwasher to modify the faucet where the dishwasher will be used.

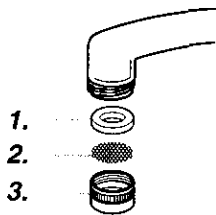

1. Washer
2. Screen
3. Screen holder or aerator

NOTE: Remove and save the washer, screen, and screen holder or aerator for future use.

Connecting the faucet adapter to faucets with external threads

Insert the two screens and then the thin washer from the faucet adapter kit into the faucet adapter. Attach the adapter onto the end of the faucet.

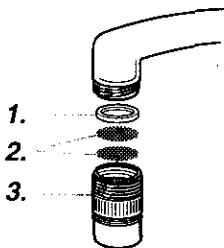

1. Thin washer
2. Screens
3. Faucet adapter

NOTE: Do not use the thick washer.

Connecting the faucet adapter to faucets with internal threads

Insert the 2 screens, the thin washer, and then the thick washer from the faucet adapter kit into the faucet adapter. Attach the adapter onto the end of the faucet.

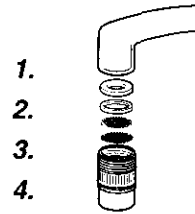

1. Thick washer
2. Thin washer
3. Screens
4. Faucet adapter

NOTE: Use both washers.

CONNECTING THE DISHWASHER HOSES TO THE WATER SUPPLY

1. Run water at the faucet until it is **hot**. Turn the water off.
2. Pull the hoses out of their storage compartment on the back of the dishwasher.

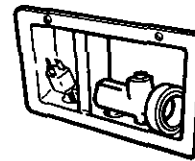

NOTE: Make sure the hoses are not kinked or twisted. Kinked hoses reduce washing performance.

3. Pull down on the locking collar while lifting the hose connector onto the faucet adapter.

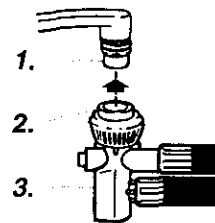

1. Faucet adapter
2. Locking collar
3. Hose connector

4. When the connector snaps into place, release the locking collar.
5. Turn the hot water on slowly until it is all the way on.
6. Plug into a grounded 3 prong outlet.

Using the Faucet

You can draw water from the faucet while the dishwasher is connected.

NOTE: Do not draw water while the dishwasher is filling or while water is being pumped out. (This helps prevent a low fill when dishwasher is filling or mixing drain water with fresh water when dishwasher is draining.)

Press the red button on the hose connector to draw water from the faucet. (The faucet is set on hot. Adjust the faucet for the water temperature you want.)

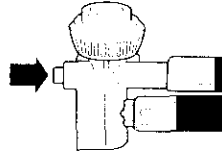

NOTE: Turn the hot water back on after you draw water from the faucet. Turn off the cold water.

Connecting the Dishwasher to the Faucet

1. Turn the hot water off. (This can be done after the last rinse.)
2. Press the red button on the connector to release the water pressure.

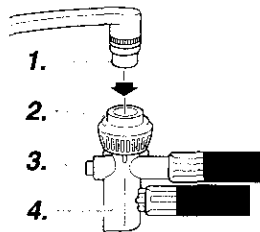

1. Faucet adapter
2. Locking collar
3. Red button
4. Hose connector

3. Lift slightly on the hose connector while pulling down the locking collar. Pull down on the connector.
4. Empty any remaining water from the connector by turning the connector upside-down.
5. Unplug the power supply cord and return it to the storage compartment.
6. Return the hoses to the storage compartment.

LOADING YOUR DISHWASHER

Preparation

- Remove leftover food, bones, toothpicks and other hard items from the dishes. It is not necessary to rinse the dishes before putting them in the dishwasher. The wash module removes food particles from the water. The module contains a chopping device which will reduce the size of food items.

NOTE: If hard items such as fruit seeds, nuts, and egg shells enter the wash module, you might hear chopping, grinding, crunching, or buzzing sounds. These sounds are normal when hard items enter the module. Do not let metallic items (such as pot handle screws) get into the wash module. Damage can occur.

- Load dishes so soiled surfaces face the spray (down or inward). It is important for the water spray to reach all soiled surfaces.
- Load dishes so they are not stacked or overlapping if possible. For best drying, water must be able to drain from all surfaces.
- Make sure pot lids and handles, pizza pans, cookie sheets, etc., do not interfere with the spray arm rotation.
- Run a rinse cycle to keep dishes moist if you do not plan to wash them soon. Foods like eggs, rice, pasta, spinach, and cooked cereals may be hard to remove if they are left to dry over a period of time.

Quiet operating tips

To avoid thumping/clattering noises during operation:

- Make sure lightweight load items are secured in the racks.
- Make sure pot lids and handles, pizza pans, cookie sheets, etc., do not touch interior walls or interfere with the rotation of the spray arm.
- Load dishes so they do not touch one another.

The top rack is designed for cups, glasses, and smaller items. (See recommended loading patterns shown.)

NOTE: The features on your dishwasher rack may vary from the drawings shown.

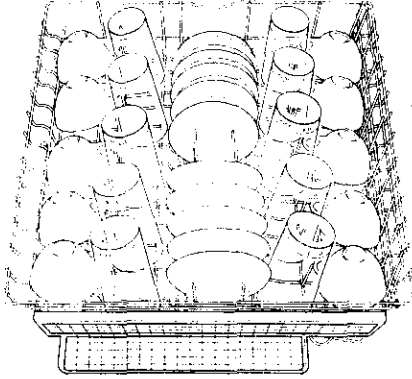

10 place setting

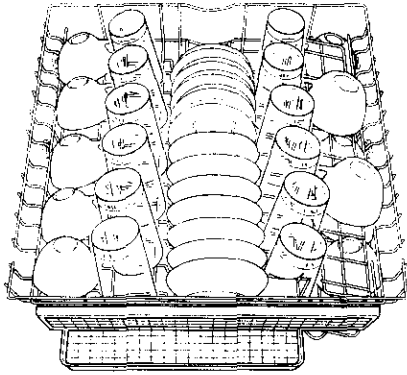

12 place setting

- Place items so open ends face down for cleaning and draining.
- Load glasses in top rack only. The bottom rack is not designed for glasses. Damage can occur.
- Place cups and glasses in the rows between prongs. Placing them over the prongs can lead to breakage.
- China, crystal, and other delicate items must not touch each other during dishwasher operation. Damage may occur.
- Load plastic items in the top rack only. Only plastic items marked "dishwasher safe" are recommended.
- Load plastic items so the force of the spray does not move them during the cycle.
- To avoid chipping, do not let stemware touch other items.
- Small bowls, pans, and other utensils can be placed in the top rack. Load bowls in the center section for best stability.

Utensil basket

Use this extra capacity basket on the top rack to hold spatulas, wooden spoons, and similar items.

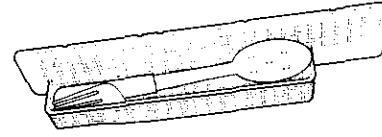

No-flip clips (on some models)

The no-flip clips hold lightweight plastic items like cups, lids, or bowls in place during washing. You can move a clip anywhere in the rack.

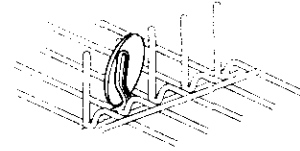

1. Pull the clip up and off the tine.
2. Reposition the clip on another tine.

The bottom rack is designed for plates, pans, casseroles, and utensils. Items with cooked-on or dried-on food should be loaded with soiled surfaces facing inward to the spray. (See recommended loading patterns shown.)

NOTE: The features on your dishwasher rack may vary from the drawings shown.

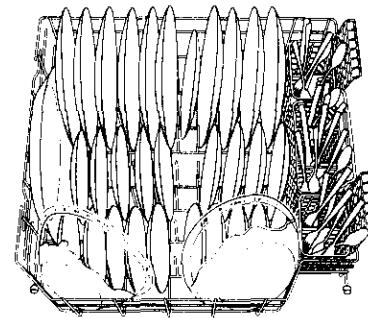

10 place setting

- Do not load glasses, cups, or plastic items in the bottom rack. Load small items in the bottom rack only if they are secured in place.
- Load plates, soup bowls, etc., between prongs and facing inward to the spray.
- Overlap the edges of plates for large loads.

- Load soup, cereal, and serving bowls in the rack in a variety of ways depending upon their size and shape. Load bowls securely between the rows of prongs. Do not nest bowls because the spray will not reach all surfaces.

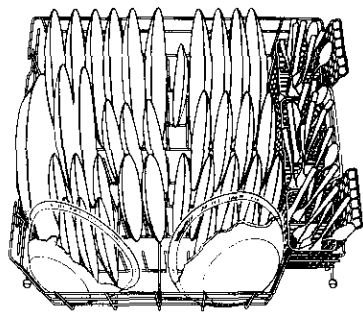

12 place setting

- Load cookie sheets, cake pans, and other large items at the sides and back. Loading such items in front can keep the water spray from reaching the detergent dispenser.
- Secure heavily soiled cookware face down in the rack.
- Make sure pot handles and other items do not stop rotation of the spray arm(s). The spray arm(s) must move freely.
- Do not load items between the bottom rack and the side of the dishwasher tub. You can block the water inlet opening.

NOTE: If you have removed the bottom rack for unloading or cleaning, replace it with the bumpers in front.

Fold-down tines

You can fold down one or both rows of tines at the back of the bottom rack.

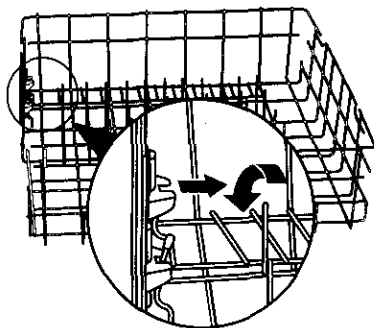

1. Grasp the tip of the tine that is in the tine holder.
2. Gently pull the tine out of the tine holder.
3. Lay the row of tines down in the rack to make room for larger dishes, bowls, pots, pans or roasters.

Loading the Silverware Basket

Load the silverware basket while it is in the bottom rack or take the basket out for loading on a counter or table.

NOTES:

- Silverware basket covers are available on some models.
- Unload or remove the basket before unloading the racks to avoid spilling water droplets on the silverware.

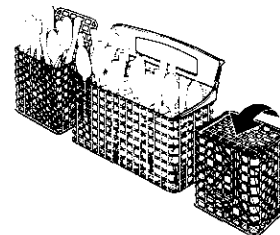

- Place small items like baby bottle caps, jar lids, corn cob holders, etc., in the section(s) with hinged cover(s). Close the cover to hold small items in place.
- This silverware basket can be separated and placed into the bottom rack in several locations. Load silverware in all sections or just one, depending upon your load.
- Mix items in each section of the basket with some pointing up and some down to avoid nesting. Spray cannot reach nested items.

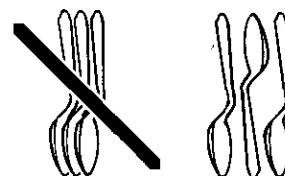

IMPORTANT: Always load sharp items (knives, skewers, forks, etc.) pointing down.

To remove a small basket

1. Hold the center basket and one small basket. Slide the small basket forward to release the tabs from the corresponding slots.

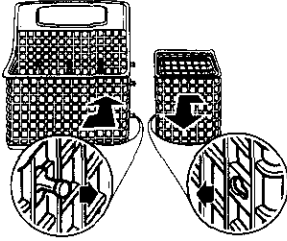

2. Pull the baskets apart.

NOTES:

- Do not load silver or silver-plated silverware with stainless steel. These metals can be damaged by contact with each other during washing.
- Some foods (such as salt, vinegar, milk products, fruit juices, etc.) can pit or corrode silverware. Run a rinse cycle if you do not have a full load to wash immediately.

USING YOUR DISHWASHER

The detergent dispenser has 2 sections. The Pre-Wash section empties detergent into the dishwasher when you close the door.

1 2 3 4



1. Cover
2. Main wash section
3. Cover latch
4. Pre-wash section

The larger Main Wash section automatically empties detergent into the dishwasher during the main wash. (See the "Cycle Selection Chart.")

- Use automatic dishwashing detergent only. Other detergents can produce excessive suds that can overflow out of the dishwasher and reduce washing performance.
- Add detergent just before starting cycle.
- Store tightly closed detergent in a cool, dry place. Fresh automatic dishwasher detergent results in better cleaning.

NOTE: Do not use detergent with a rinse cycle.

Filling the dispenser

1. If the dispenser cover is closed, open the cover by pushing the Cover latch.
2. Fill the Main Wash section with detergent. See "How Much Detergent to Use."
3. Close the Main Wash dispenser cover. Fill the Pre-Wash section if needed.

It is normal for the cover to open partially when dispensing detergent.

NOTE: Use both sections for cycles with 2 washes. Use only the covered section for cycles with 1 wash. See the "Cycle Selection Chart" for more details.

How much detergent to use

- The amount of detergent to use depends on the hardness of your water and the type of detergent. If you use too little, dishes won't be clean. If you use too much in soft water, glassware will etch.
- Water hardness can change over a period of time. Find out your water's hardness by asking your local water department, water softener company, or county extension agent.
- Different brands of dishwasher detergent have different amounts of phosphorous for softening water. If you have hard water and use a detergent with a phosphorous content of less than 8.7%, you might need to use more detergent, or use a detergent with a phosphorous content higher than 8.7%.

Where to fill



Top of 3rd step (3 tbs or 45 g)



Top of 2nd step (2 tbs or 30 g)



Top of 1st step (1 tb or 15 g)

Water Hardness Amount of Detergent

Soft to Medium Hard Water

0 to 6 grains per gallon

For normally soiled loads

- Fill the Main Wash section to the top of the 2nd step (2 tbs or 30 g)
- Fill the Pre-Wash section to the top of the 2nd step (2 tbs or 30 g) if needed

NOTE: Add only 1 tb or 15 g of detergent to both sections if dishes are pre-rinsed or the water is very soft (0 to 2 grains per gallon).

For heavily soiled loads

- Fill the Main Wash section to the top of the 3rd step (3 tbs or 45 g)
- Fill the Pre-Wash section to the top of the 2nd step (2 tbs or 30 g)

Medium to Hard Water

7 to 12 grains per gallon

For normally soiled and heavily soiled loads

- Fill the Main Wash section to the top of the 3rd step (3 tbs or 45 g)
- Fill the Pre-Wash section to the top of the 2nd step (2 tbs or 30 g) if needed

NOTE: Fill amounts shown are for standard powdered detergent. Amounts may vary if you use liquid or concentrated powdered detergent. Follow instructions on the package when using liquid dishwasher detergent or concentrated powdered detergent.

Rinse Aid Dispenser

Rinse aids prevent water from forming droplets that can dry as spots or streaks. They also improve drying by allowing water to drain off of the dishes during the final rinse by releasing a small amount of the rinse aid into the rinse water. Your dishwasher is designed to use a liquid rinse aid. Do not use a solid or bar-type.

Checking the dispenser

Check the center of the Fill Indicator cap. Clear means it needs filling.

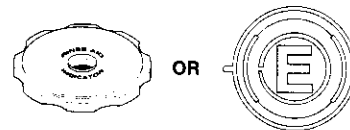

Or you can remove the Fill Indicator cap. If an "E" is visible, the dispenser is empty.

Filling the dispenser

The rinse aid dispenser holds 6 oz (175 mL) of rinse aid. Under normal conditions, this will last for about three months. You do not have to wait until the dispenser is empty to refill it. Try to keep it full, but be careful not to overfill it.

1. Make sure the dishwasher door is completely open.
2. Remove the Fill Indicator cap.
3. Add rinse aid. Fill to the smallest opening in the lower part of the dispenser. Overfilling can cause the rinse aid to leak out, and could cause oversudsing.

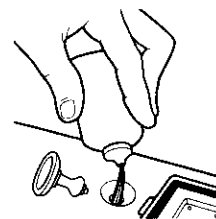

4. Clean up any spilled rinse aid with a damp cloth.
5. Replace the Fill indicator cap. Close tightly.

Dishwasher Efficiency Tips

Hot water dissolves and activates the dishwashing detergent. Hot water also dissolves grease on dishes and helps glasses dry spot-free. For best dishwashing results, water must be at least 120°F (49°C) as it enters the dishwasher. Loads may not wash as well if the water temperature is too low.

To check water temperature

1. Run hot water at the faucet closest to your dishwasher for at least 1 minute.
2. Place a candy or meat thermometer in a glass measuring cup.



3. Check the temperature on the thermometer as the water is running into the cup.

4. If the water temperature at the faucet is below 120°F (49°C), have a qualified person raise the water heater's thermostat setting.
- To save water and energy, do not rinse dishes before putting them into the dishwasher.
 - Use a low energy, quick, or short cycle whenever possible. These cycles use less hot water and energy than the Normal cycle.
 - Use a delay feature (on some models) to run your dishwasher during off-peak hours. Local utilities recommend avoiding heavy usage of energy at certain times of day.
 - During the summer, run your dishwasher at night to reduce daytime heat buildup.
 - Use an air dry, or an energy-saving dry option whenever possible. Allow longer drying times (overnight) when using these options. Use a rinse aid to improve drying.
 - Use cycles or options that add extra heat to the wash or rinse portion of the cycle only when needed.
 - Run your dishwasher with full loads. Run a rinse cycle after meals until the dishwasher is full.

NOTE: Use the Water Heat option on your dishwasher if you keep your water heater at a low setting. For more information, see "Dishwasher seems to run too long" in the "Troubleshooting" section.

Control Panel

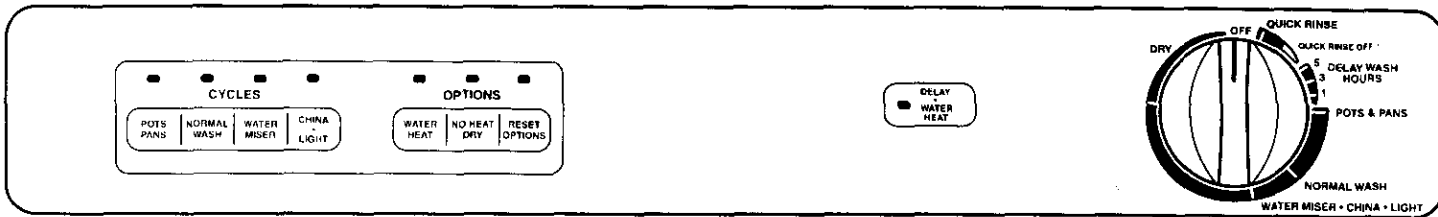

Select the wash cycle. If the door is latched, you will hear the cycles start and stop as the Cycle Control knob passes each cycle mark. This is normal and does not hurt the dishwasher. If you prefer, you can set the Cycle Control knob with the door unlatched.

Press the desired cycle. Turn the Cycle Control knob to the desired cycle. To use Quick Rinse, press any cycle and turn the Cycle Control knob to QUICK RINSE.

A "●" shows what steps are in each cycle.

Temperatures indicate where extra heat is added.

Water usage is shown in U.S. gallons/liters.

Cycle time includes dry time. An asterisk (*) by the cycle time indicates the cycle time might be longer depending on the temperature of the water entering the dishwasher. The cooler the water, the longer the cycle time. If the water is already hot enough, the cycle time will be as shown.

NOTE: The Cycle Control knob will pause while water is being heated.

NORMAL WASH Use this cycle for loads with normal amounts of food soil. (The energy-usage label is based on this cycle.) **Use both detergent dispenser sections.**

Wash	Rinse	Main Wash	Rinse	Dry	Time (min)	Water Usage (gal/L)
●		● 140°F (60°C)	● 135°F (57°C)	●	72*	6.9/26.1

WATER MISER Use this cycle for pre-rinsed and lightly-soiled loads. This cycle uses less hot water than the Normal Wash cycle. **Use covered detergent dispenser section.**



Wash	Rinse	Main Wash	Rinse	Dry	Time (min)	Water Usage (gal/L)
		● 140°F (60°C)	● 135°F (57°C)	●	62*	4.8/18.2

POTS PANS Use this cycle for hard-to-clean, heavily-soiled pots, pans, casseroles, and regular tableware. **Use both detergent dispenser sections.**

Wash	Rinse	Main Wash	Rinse	Dry	Time (min)	Water Usage (gal/L)
● 135°F (57°C)	●	● 140°F (60°C)	● 135°F (57°C)	●	88*	9.1/34.4

CHINA LIGHT Use this cycle for china and crystal. This cycle uses a light wash and gentle dry. During the heated dry, the heating element cycles on and off. **Use covered detergent dispenser section.**

Wash	Rinse	Main Wash	Rinse	Dry	Time (min)	Water Usage (gal/L)
		● 140°F (60°C)	● 135°F (57°C)	●	62*	4.8/18.2

 <p>Use this rinse cycle for rinsing dishes, glasses, and silverware that will not be washed right away.</p>		<p>Do not use detergent with this cycle.</p> 				
Wash	Rinse	Main Wash	Rinse	Dry	Time (min)	Water Usage (gal/L)
			●		6	2.2/8.3

Stopping a Cycle

You can cancel a cycle at any time.

1. Turn the Cycle Control knob slowly clockwise until you hear water draining. Let the dishwasher drain completely.
2. Open the door.
3. Turn the Cycle Control knob to OFF.

Changing a Cycle or Setting

If your dishwasher has more than one wash cycle, you can change a cycle anytime during a cycle.

1. Lift the door latch to stop the cycle.
2. Turn the Cycle Control knob clockwise.
3. Check the detergent dispensers. They must be filled properly for the new cycle.

NOTE: Turning the Cycle Control knob can cause the covered Detergent Dispenser section to open and release the detergent. Check the covered section if the cycle uses detergent in both sections.

4. Close the door firmly until it latches. The dishwasher starts a new cycle.

Adding Items During a Cycle

You can add an item anytime before the main wash starts, or the Cycle Control knob reaches Water Miser or China/Light cycles.

1. Lift up the door latch to stop the cycle. Wait for the spraying action to stop before opening the door.
2. Open the door and add the item.
3. Close the door, but do not latch it. Wait 30 seconds for the air in the dishwasher to warm up. This reduces the amount of moisture escaping from the vent when restarting a cycle.
4. Close the door firmly until it latches. The dishwasher resumes the cycle.

Option Selection

You can customize your cycles by pressing an option. If you change your mind, press RESET OPTIONS to turn the option off. Select a different option if desired.

You can change an option anytime before the selected option begins. For example, you can press an unheated drying option any time before drying begins.

Water Heat

Select this option to heat the water to 140°F (60°C) during parts of the cycle. (See the Cycle Chart.) Heating the water helps improve washing results. This option adds both heat and wash time to parts of the cycle.



NOTE: Pots Pans automatically uses this option. Water Heat is an option with the Normal Wash, Water Miser and China/Light cycles.

No Heat Dry

Select this energy-saving option to dry without heat. No Heat drying is useful when loads contain plastic dinnerware that may be sensitive to high temperatures.



The dishes take longer to dry and some spotting can occur. For best drying, use a liquid rinse aid. Some items (such as plastics) may need towel drying.

NOTE: Quick Rinse and China/Light automatically use this option. No Heat Dry is an option with all other cycles.

Reset Options

Select Reset Options to change an option anytime before the selected option begins.



Delay Wash

Select this option to run your dishwasher at a later time or during off-peak hours.

You can delay the start of a cycle up to 5 hours.

To delay the start

1. Close the door.
2. Select a wash cycle and option.

Press the desired cycle. Turn the Cycle Control knob clockwise to the number of hours you want the dishwasher to delay the start. The Delay status indicator will glow.



The dishwasher starts the cycle in the selected number of hours. You can add items while the time is counting down.

3. Close and latch the door. The Cycle Control knob will not advance if the door is unlatched.

NOTE: Quick Rinse, Water Miser, and China/Light cycles cannot be delayed.

IMPORTANT:

- Operate your dishwasher only when you are at home.
- If your home is equipped with a water softener, do not start the dishwasher during the regeneration of the softener.

Delay/Water Heat

If you delay a wash cycle, the indicator glows to indicate the delay is set.

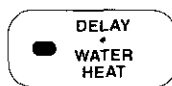

The Delay/Water Heat status indicator also glows when the dishwasher heats water to the proper dishwashing temperature. This happens when your household water is not hot enough.

NOTE: The Cycle Control knob pauses while the water heats.

During drying, you can see steam escaping through the vent at the upper left corner of the door. This is normal as the heat dries your dishes.

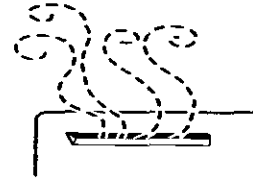

IMPORTANT: The vapor is hot. Do not touch the vent during drying.

The overflow protection float (in the front right corner of the dishwasher tub) keeps the dishwasher from overflowing. It must be in place for the dishwasher to operate.



Check under the float for objects that may keep the protector from moving up or down.

WASHING SPECIAL ITEMS

If you have doubts about washing a particular item, check with the manufacturer to see if it is dishwasher safe.

Material	Dishwasher Safe?/Comments
Aluminum	Yes High water temperature and detergents can affect finish of anodized aluminum.
Disposable Aluminum	No Do not wash throwaway aluminum pans in the dishwasher. These might shift during washing and transfer black marks to dishes and other items.
Bottles and Cans	No Wash bottles and cans by hand. Labels attached with glue can loosen and clog the spray arms or pump and reduce washing performance.
Cast Iron	No Seasoning will be removed and iron will rust.
China/ Stoneware	Yes Always check manufacturer's recommendations before washing. Antique, hand-painted, or over-the-glaze patterns may fade. Gold leaf can discolor or fade.
Crystal	Yes Check manufacturer's recommendations before washing. Some types of leaded crystal can etch with repeated washing.
Gold	No Gold-colored flatware will discolor.
Glass	Yes Milk glass yellows with repeated dishwasher washing.
Hollow-Handle Knives	No Handles of some knives are attached to the blade with adhesives which can loosen if washed in the dishwasher.

Material	Dishwasher Safe?/Comments
Pewter, Brass, Bronze	No High water temperatures and detergent can discolor or pit the finish.
Disposable Plastics	No Cannot withstand high water temperatures and detergents.
Plastics	Yes Always check manufacturer's recommendations before washing. Plastics vary in their capacity to withstand high temperatures and detergents. Load plastics in top rack only.
Stainless Steel	Yes Run a rinse cycle if not washing immediately. Prolonged contact with food containing salt, vinegar, milk products, or fruit juice can damage finish.
Sterling Silver or Silver Plate	Yes Run a rinse cycle if not washing immediately. Prolonged contact with food containing salt, acid, or sulfide (eggs, mayonnaise, and seafood) can damage finish.
Tin	No Can rust.
Wooden Ware	No Wash by hand. Always check manufacturer's instructions before washing. Untreated wood can warp, crack, or lose its finish.

CARING FOR YOUR DISHWASHER

Cleaning the exterior

In most cases, regular use of a soft, damp cloth or sponge and a mild detergent is all that is necessary to keep the outside of your dishwasher looking nice and clean.

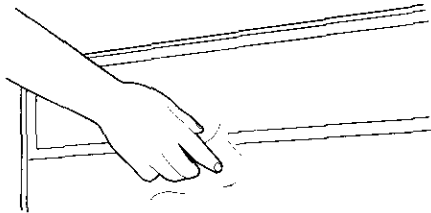

Cleaning the interior

Hard water minerals can cause a white film to build up on the inside surfaces, especially just beneath the door area.

Do not clean the dishwasher interior until it has cooled. Wear rubber gloves. **Do not** use any type of cleanser other than dishwasher detergent because it may cause foaming or sudsing.

To clean interior

Make a paste with powdered dishwasher detergent on a damp sponge and clean.

OR

Use liquid automatic dishwasher detergent and clean with a damp sponge.

OR

See the vinegar rinse procedure in "Spotting and filming on dishes" in "Troubleshooting."

NOTE: Run a Normal cycle with detergent after cleaning the interior.

Storing for the summer

Protect your dishwasher during the summer months by turning off the water supply and power supply to the dishwasher.

Moving or winterizing your dishwasher

Protect your dishwasher and home against water damage due to freezing water lines. If your dishwasher is left in a seasonal dwelling or could be exposed to near freezing temperatures, have a qualified person do the following:

1. Disconnect power supply to the dishwasher.

2. Remove the 4 screws on the lower access panel. Remove the lower access panel.

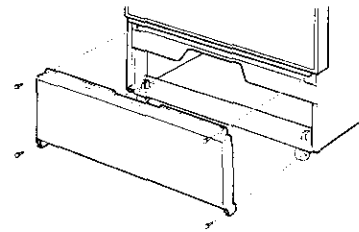

3. Place a shallow pan under the water supply valve. Then, use a wrench to disconnect the water inlet from the water supply valve. Separate the water inlet from the water supply valve and drain water into the pan.

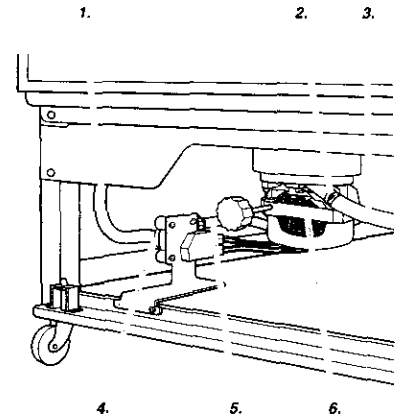

1. Water outlet
2. Hose clamp
3. Drain hose
4. Water supply valve
5. Water inlet
6. Water pump and motor

4. Remove the spring clamp from the water outlet and separate from the water supply valve; drain water into pan.
5. Reconnect both water inlet and water outlet to the water supply valve.
6. Empty the pan and reposition it under the water pump.
7. Remove the clamp and disconnect the drain hose from the water pump; drain water into pan.
8. Reconnect drain hose to the water pump, being sure to position the clamp over the connection.
9. Replace the lower access panel.

Reconnecting your dishwasher

1. Remove the 4 screws on the lower access panel and remove lower access panel.
2. Turn on the water supply to dishwasher.
3. Run dishwasher through a complete cycle and check for leaks.
4. Replace lower access panel.

TROUBLESHOOTING

First try the solutions suggested here and possibly avoid the cost of a service call...

Dishwasher is not operating properly

- **Dishwasher does not run or stops during a cycle**
 - Is the door closed tightly and latched?
 - Is the right cycle selected? Refer to the "Cycle Selection Chart."
 - Is there power to the dishwasher? Has a household fuse blown or circuit breaker tripped?
 - Has the motor stopped due to an overload? The motor automatically resets itself within a few minutes. If it does not restart, call for service.
 - Is the water shut-off valve (if installed) turned on?
- **Dishwasher will not fill**
 - Is the overflow protection float able to move up and down freely? Press down to release.
- **Dishwasher seems to run too long**
 - Is the water supplied to the dishwasher hot enough? The dishwasher runs longer while heating water. Refer to the "Water Temperature Tips" section.
 - A delay automatically occurs in some wash and rinse cycles until the water reaches the proper temperature.
- **Water remains in the dishwasher**
 - Is the cycle complete?
- **Detergent remains in the covered section of the dispenser**
 - Is the cycle complete?
 - Is the detergent lump-free? Replace detergent if necessary.
 - Is the bottom rack installed properly with the bumpers in the front? Refer to the "Parts and Features" section. Reinstall the rack if necessary.
- **White residue on the front of the access panel**
 - Was too much detergent used? Refer to the "Detergent Dispenser" section.
 - Is the brand of detergent making excess foam? Try a different brand to reduce foaming and eliminate buildup.
- **Odor in the dishwasher**
 - Are dishes washed only every 2 or 3 days? Run a rinse cycle once or twice a day until you have a full load.
 - Does the dishwasher have a new plastic smell? Run a vinegar rinse as described in "Spotting and filming on dishes" later in this Troubleshooting guide.
- **Condensation on the kitchen counter (built-in models)**
 - Is the dishwasher aligned with the counter top? Moisture from the vent in the dishwasher console can form on the counter. Refer to the Installation Instructions for more information.

Dishes are not completely clean

- **Food soil left on the dishes**
 - Is the dishwasher loaded correctly? Refer to the "Loading Your Dishwasher" section.
 - Is the water temperature too low? If needed, turn home water heater up to ensure water entering dishwasher is at least 120°F (49°C). Refer to the "Dishwasher Efficiency Tips" section.
 - Did you use the correct amount of fresh detergent? Use recommended dishwasher detergents only. Refer to the "Detergent Dispenser" section. Never use less than 1 tb (15 g) per load. Detergent must be fresh to be effective. Store detergent in a cool, dry area. Heavy soil and/or hard water generally require extra detergent.
 - Is detergent caked in dispenser? Use fresh detergent only. Do not allow detergent to sit for several hours in a wet dispenser. Clean dispenser when caked detergent is present.
 - Is the pump or spray arm clogged by labels from bottles and cans? Remove labels before washing bottles and cans or wash by hand.
 - Is the home water pressure high enough for proper dishwasher filling? Home water pressure should be 20 to 120 psi (138 to 828 kPa) for proper dishwasher fill. A booster pump on the water supply can be added if pressure is too low.
 - Are high suds slowing the wash arm? Never use soap or laundry detergents. Use recommended dishwasher detergents only.

Spots and stains on dishes

- **Spotting and filming on dishes**
 - Is your water hard or is there a high mineral content in your water? Conditioning the final rinse water with a liquid rinse aid helps eliminate spotting and filming. Keep the rinse aid dispenser filled.
 - Is the water temperature too low? If needed, turn home water heater up to ensure water entering dishwasher is at least 120°F (49°C). Refer to the "Dishwasher Efficiency Tips" section.
 - Did you use the correct amount of effective detergent? Use recommended dishwasher detergents only. Refer to the "Detergent Dispenser" section. Never use less than 1 tb (15 g) per load. Detergent must be fresh to be effective. Store detergent in a cool, dry area. Heavy soil and/or hard water generally require extra detergent.
 - Is the home water pressure high enough for proper dishwasher filling? Home water pressure should be 20 to 120 psi (138 to 828 kPa) for proper dishwasher fill. A booster pump on the water supply can be added if pressure is too low.
- NOTE:** To remove spots and film from dishes, try a white vinegar rinse. This procedure is intended for occasional use only. Vinegar is an acid and using it too often could damage your dishwasher.

1. Wash and rinse dishes. Use an air-dry or an energy saving dry option. Remove all silverware or metal items.
2. Put 2 cups (473 mL) white vinegar in a glass or dishwasher-safe measuring cup on the bottom rack.
3. Run the dishwasher through a complete washing cycle using an air-dry or an energy saving dry option. Do not use detergent. Vinegar will mix with the wash water.

■ **Silica film or etching (silica film is a milky, rainbow-colored deposit; etching is a cloudy film)**

Sometimes there is a water/chemical reaction with certain types of glassware. This is usually caused by some combination of soft or softened water, alkaline washing solutions, insufficient rinsing, overloading the dishwasher, and the heat of drying. It might not be possible to prevent the problem, except by hand washing.

To slow this process use a minimum amount of detergent but not less than 1 tb (15 g) per load. Use a liquid rinse aid and underload the dishwasher to allow thorough rinsing. Silica film and etching are permanent and cannot be removed. Do not use heated drying.

- **White spots on cookware with non-stick finish**
Has the dishwasher detergent removed cookware seasoning? Reseason cookware after washing in the dishwasher.
- **Brown stains on dishes and dishwasher interior**
Does your water have high iron content? Rewash dishes using 1-3 tsp (5-15 mL) of citric acid crystals added to the covered section of the detergent dispenser. Do not use detergent. Follow with a Normal wash cycle with detergent. If treatment is needed more often than every other month, the installation of an iron removal unit is recommended.
- **Black or gray marks on dishes**
Are aluminum items rubbing dishes during washing? Disposable aluminum items can break down in the dishwasher and cause marking. Hand wash these items. Remove aluminum markings by using a mild abrasive cleaner.
- **Orange stains on plastic dishes or dishwasher interior**
Are large amounts of tomato-based foods on dishes placed in the dishwasher? Stains gradually fade over time. Regular use of heated drying will slow fading. Stains will not affect dishwasher performance. Regular use of a rinse cycle and an air-dry or energy-saving dry option will reduce the likelihood of staining.

Dishes do not dry completely

■ **Dishes are not dry**

Did you load your dishwasher to allow proper water drainage? Do not overload. Refer to the "Loading Your Dishwasher" section. Use a liquid rinse aid to speed drying.

Are the plastics wet? Plastics often need towel drying.

Is the rinse aid dispenser empty? Refer to the "Rinse Aid Dispenser" section.

Did you use an air-dry or energy-saving dry option? Use a heated drying option for dryer dishes.

Dishes are damaged during a cycle

■ **Chipping of dishes**

Did you load the dishwasher properly? Load the dishes and glasses so they are stable and do not strike together from washing action. Minimize chipping by moving the rack in and out slowly.

NOTE: Antiques, feather-edged crystal, and similar types of china and glassware might be too delicate for automatic dishwashing. Wash by hand.

Noises

- **Grinding, grating, crunching or buzzing sounds**
A hard object has entered the wash module (on some models). The sound should stop when the object is ground up.

**For in-home repair of a major appliance,
no matter who made it, no matter who sold it!**

Call 24 hours a day, 7 days a week

1-800-4-MY-HOMESM (1-800-469-4663)

Para pedir servicio o ordenar piezas:

1-888-SU-HOGARSM (1-888-784-6427)

Pour tout le service:

1-877-LE-FOYERSM (1-877-533-6937)

**For repair of carry-in products like
vacuums, lawn mowers, stereos and VCRs,
call for the nearest Sears Service Center location.**

Call 24 hours a day, 7 days a week

1-800-488-1222

**For the replacement parts and owner's manuals that
you need to "do-it-yourself," call and ask for PartsDirect.SM**

Call 6 a.m. – 11 p.m. CT, 7 days a week

1-800-4-MY-HOMESM (1-800-469-4663)

www.sears.com/partsdirect

For a Sears Service Agreement purchase or inquiry:

Call 7 a.m. – 5 p.m. CT, Monday – Saturday

1-800-827-6655

