

Dishwasher
Lave-Vaisselle



BOSCH

en Operating instructions
fr Guide d'Utilisation

9000986246 (9501)

Dear Valued Customer,

Welcome and congratulations on your new Bosch® dishwasher purchase! Our German engineers work tirelessly to craft machines with virtually silent operation, resource-saving efficiency, and optimum quality. We know you'll be pleased.

For other premium Bosch® appliances, visit us online at:
www.bosch-home.com/us (USA)

or

www.bosch-appliances.ca (Canada)

While there, don't forget to register your new dishwasher by clicking on the Support tab or filling out the product registration card enclosed with your new unit.

If you have any questions or comments, please contact us at: 1-800-944-2904
or write us at:

<http://www.bosch-home.com/us/customer-support/contact-us.html>

Table of Contents

Important Safety Instructions.....	2-3
Dishwasher Components.....	4-5
Dishwasher Setup.....	6-8
Dishware Materials.....	9
Loading the Dishwasher.....	10-11
Rack Features.....	12
Dishwasher Cycles and Options.....	13
Wash Cycle Information.....	14
Operating the Dishwasher.....	15-17
Care and Maintenance.....	18-19
Troubleshooting Guide.....	20-22
Customer Service.....	23
Statement of Limited Product Warranty	24

IMPORTANT SAFETY INSTRUCTIONS:

Please READ and SAVE this information

WARNING

Misuse of the dishwasher can result in serious injury or death. Do not use the dishwasher in any way not covered in this manual or for any purpose other than those explained in the following pages.



Severe product damage and/or injury could result from the use of unqualified service technicians or non-original replacement parts. All repairs must be performed by a qualified service technician using only original equipment factory replacement parts.



Electrical shock or fire could result if the electrical supply for the dishwasher covered in this manual is incorrectly installed or if the dishwasher has been improperly grounded. Do not use the dishwasher covered in this manual unless you are certain the electrical supply has been correctly installed and the dishwasher has been properly grounded.



Never use harsh chemicals to clean your dishwasher. Some chloride-containing products can damage your dishwasher and may present health hazards!

NOTICE

Never use steam cleaning products to clean your dishwasher. The manufacturer will not be responsible for the possible damages or consequences.



It is highly recommended for the end user to become familiar with the procedure to shut off the incoming water supply and the procedure to shut off the incoming power supply. See the Installation Instructions or contact your installer for more information.



To avoid possible dishwasher damage, do not use harsh chemicals, abrasive cleaners, scouring pads (metal or plastic), or abrasive cloths/paper towels to clean your dishwasher's exterior door panel. Your dishwasher's exterior door panel can be damaged by doing so.



NSF/ANSI 184 Certified residential dishwashers are not intended for licensed food establishments.



WARNING: To reduce the risk of fire, electrical shock, or serious injury, observe the following:

- 1 This dishwasher is provided with Installation Instructions and this Use and Care Manual. Read and understand all instructions before using the dishwasher.
- 2 This appliance must be grounded to a metal, permanent wiring system, or an equipment grounding conductor must be run with the circuit conductors and connected to the equipment grounding terminal or lead on the dishwasher. See the Installation Instructions included with this dishwasher for more information on electrical requirements.
- 3 Use this dishwasher only for its intended function, which is the washing of household dishware and kitchenware rated as dishwasher safe.
- 4 Use only detergents or rinsing agents recommended for use in a dishwasher, and keep them out of the reach of children.
- 5 When loading items to be washed:
 - Locate sharp items so they are not likely to damage the door seal.
 - Load knives and other sharp utensils with their HANDLES UP to reduce the risk of cut-type injuries.
 - Do not wash plastic items unless they are marked “dishwasher safe” or the equivalent. For plastic items not so marked, check the manufacturer’s recommendations.
 - Do not operate your dishwasher unless all enclosure panels are in place.
 - Do not tamper with or override controls and interlocks.
- 6 Do not abuse, sit or stand on the door or dish racks of the dishwasher.
- 7 To reduce risk of injury, do not allow children to play in or on the dishwasher.
- 8 When children become old enough to operate the appliance, it is the responsibility of the parents/legal guardians to ensure the children are instructed in safe practices by qualified persons.
- 9 Under certain conditions, hydrogen gas may be produced in a hot water system that has not been used for two weeks or more. Hydrogen gas is explosive. Before using a dishwasher that is connected to a hot water system that has been unused for two weeks or longer, turn on all hot water faucets and let the water flow from each for several minutes. This will release any accumulated hydrogen gas. As the gas is explosive, do not smoke or use an open flame during this time.
- 10 Remove the dishwasher door to the washing compartment when removing an old dishwasher for service or discarding.
- 11 To avoid floor damage and possible mold growth, do not allow wet areas to remain around or under the dishwasher.
- 12 Protect your dishwasher from the elements. Protect against freezing to avoid possible damage to the fill valve. Damage caused by freezing is not covered by the warranty.
- 13 This appliance must be grounded. In the event of a malfunction or breakdown, grounding will reduce the risk of electric shock by providing a path of least resistance for electric current. This appliance is equipped with a cord having an equipment-grounding conductor.
 - Improper connection of the equipment-grounding conductor can result in risk of electric shock. Check with a qualified electrician or service representative if you are in doubt whether the appliance is properly grounded.

State of California Proposition 65 Warnings:

WARNING: This product contains one or more chemicals known to the State of California to cause cancer, birth defects, or other reproductive harm.

Dishwasher Components

	Wash Cycles			
Model	Heavy	Auto	Normal	Rinse
SGE53U5xUC*	●	●	●	●

	Wash Cycle Options			
Model	Delay	Delicate	Sanitize	Extra Shine®
SGE53U5xUC*	●	●	●	●

* x can be any number

Additional Features	Description
Rackmatic®	3 position adjustable upper rack. The height of the upper rack can be adjusted in 3 positions to create more space.
Time Remaining Indicator	Indicates the cycle time remaining.
46 dBA Sound Level	Quiet washing.
Delay Start	Start of a cycle can be delayed in 1-hour increments up to 24 hours.
Rinse Cycle	If you need to pre-rinse dishes to avoid odors, let the dishwasher do the work for you. Place unrinsed dishes inside dishwasher and select the “Rinse” cycle. Uses less water than hand rinsing and very low energy. <i>Note: Do not use detergent in this cycle.</i>
Tab Tray / Upper Rack Handle	Place detergent tabs inside the dispenser as normal. The tabs fall into the tab tray and dissolve perfectly every time. Also serves as an upper rack handle.
24/7 AquaStop® Leak Protection	If a leak has occurred, it shuts down operation and automatically pumps out water to avoid contact with the floor.
2 Flip Tine rows in lower rack	Folds down to improve loading versatility.
Cup Shelves	Can be used for cups or larger serving utensils.
Child Lock	The Child Lock feature allows you to disable the dishwasher control panel to prevent accidental activation.
Plastic Item Clips	Securely holds light-weight plastic accessories (cups, lids, etc.).
Low Salt Notification Light	Illuminates to indicate Salt is low.
Low Rinse Aid Notification Light	Illuminates to indicate Rinse Aid is low.
Sanitized Notification Light	Illuminates to indicate sanitation requirements are met. Only available in Heavy, Auto, or Normal cycles.
Energy Efficient 259 kWh	ENERGY STAR® qualified.

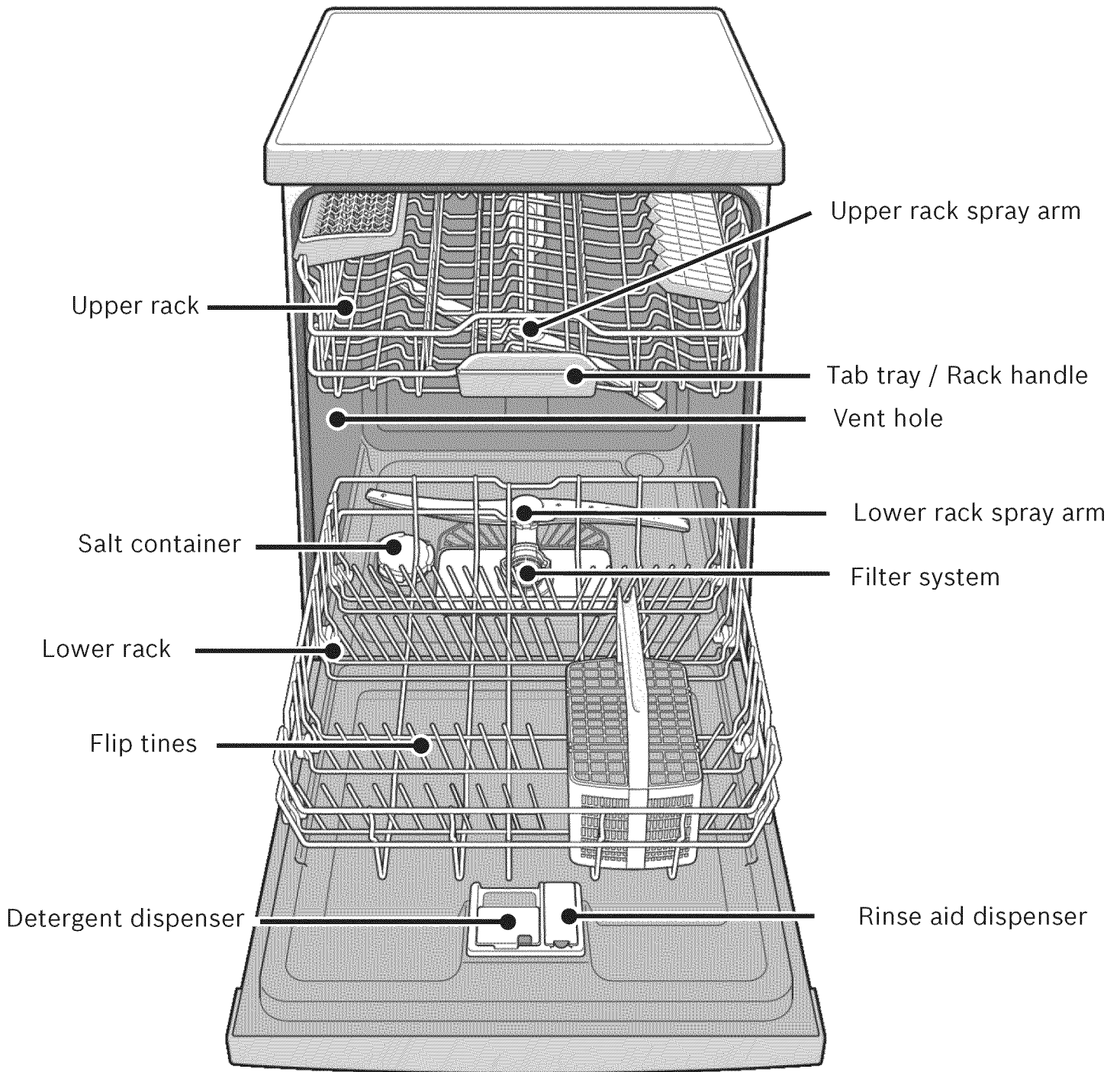

Dishwasher Setup

Water Softening System

Your dishwasher requires soft water to ensure proper washing results and is equipped with an internal water softening system. However, if you have a household water softening system, the internal system provided is not needed.

For the water softening system to function properly, it will need to use dishwasher water softening salt. The amount of salt dispensed can be set from “H:00” to “H:07”. Salt is not used at H:00 (default factory setting). The amount of salt required depends on the degree of hardness of your tap water. See **Table 1**.

- 1 Turn the unit on using the **[ON/OFF]** button.
- 2 Hold down the “**A**” button (see **Figure 1**) and press **[START]** until the display indicates “**H:00**”.
- 3 Release both buttons and press the “**C**” button to select the desired setting.
- 4 Save the selected setting by pressing **[START]**.

Table 1 - Water hardness

Tap water hardness ppm CaCO ₃ /l	Setting of internal water softener	Fill water softener with salt?
0 - 110	H:00	no
120 - 140	H:01	yes
150 - 180	H:02	yes
190 - 210	H:03	yes
220 - 290	H:04	yes
300 - 370	H:05	yes
380 - 540	H:06	yes
550 - 890	H:07	yes

Figure 1

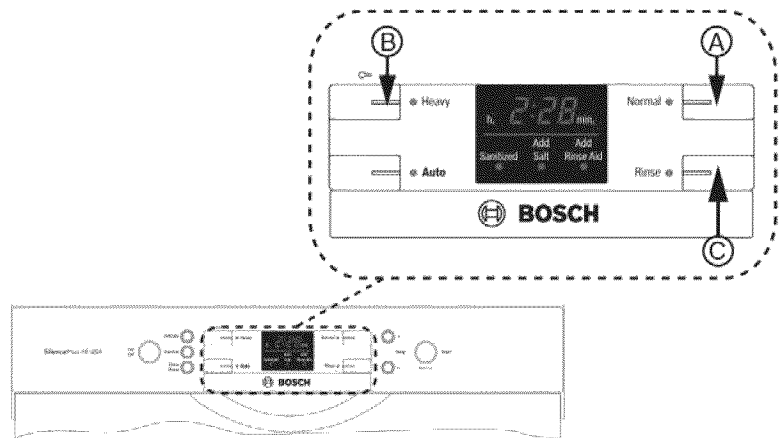

Using the water hardness test strip

Kurz eintauchen (1 sec), leicht abschütteln und nach 1 min ablesen. 4 grün/green/vert 1 rot/red/rouge 2 rot/red/rouge 3 rot/red/rouge 4 rot/red/rouge	Dip briefly (1 sec), shake off excess water and compare after 1 min. □ □ □ □ ■ □ □ □ ■ ■ □ □ ■ ■ ■ □ ■ ■ ■ ■	Plongez brièvement (1 sec), égouttez l'excès d'eau et comparez après 1 min. <3°dH/ <3.75°e/ <5.4°f >4°dH/ >5°e/ >7.2°f >8.4°dH/ >10.5°e/ >15.1°f >14°dH/ >17.5°e/ >25.2°f >21°dH/ >26.25°e/ >37.8°f	AQUADUR® Teststäbchen zur Bestimmung der Wasserhärte Test stick for determination of water hardness Bandelette pour déterminer la dureté de l'eau
--	---	--	---

Dip the test strip into tap water for a second. Shake off excess water and wait approximately 1 minute before comparing results.	After 1 minute the test strip will show you the correct setting	Setting of internal water softener	Fill water softener with salt?
□ □ □ □	0	H:00	no
□ □ □ ■	1	H:00	no
□ □ ■ ■	2	H:02	yes
□ ■ ■ ■	3	H:04	yes
■ ■ ■ ■	4	H:06	yes

Salt

Only refill the salt container, using a funnel to pour, right before turning on the unit to ensure that salt overflow is immediately washed away. This prevents corrosion. See **Figure 2**.

- 1 Open the screw cap of the salt container.
- 2 Fill the container with water (only required when turning on the unit for the first time).
- 3 Add dishwasher salt until the water is displaced and runs out.
- 4 Refill with salt as soon as the “Refill Salt” LED is lit.

Notice: Never fill the salt dispenser with detergent. It will destroy the water softening system. To prevent corrosion, refill with salt and immediately begin any cycle.

Note: Do not use salt tablets or any salt other than dishwasher water softening salt.

For more information about ordering salt please contact Customer Service (1-800-944-2904).

Figure 2

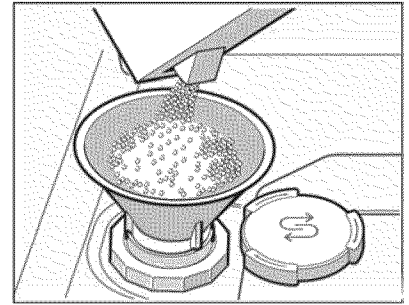

Detergent

Use only detergent specifically designed for dishwashers. For best results, use fresh powdered dishwashing detergent or detergent tabs.

NOTICE

To avoid dishwasher damage, do not use hand dishwashing products in your dishwasher.

To avoid dishwasher damage, do not use too much detergent if your water is soft. Using too much detergent with soft water may cause etching in glassware.

The dishwasher uses less water than most, therefore, less detergent is required. With soft water, 1 tablespoon (15 ml) of detergent will clean most loads. The detergent dispenser cup has lines that measure detergent (**Figure 3**) to 1 tablespoon (15 ml) and 2 tablespoons (25 ml). 3 tablespoons (45 ml) of detergent will completely fill the detergent dispenser.

Note: If you do not know the hardness of your water supply, use 15 ml (1 tbsp) of detergent. Increase the amount if necessary to the least amount required to get your kitchenware clean.

Use the measuring lines in the detergent dispenser cup as a guide to measure the amount of detergent recommended in **Table 2**.

Figure 3

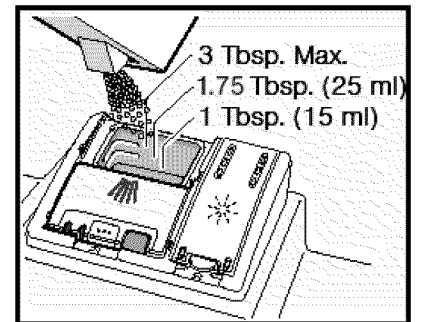

Table 2- Recommended Detergent Amount

Wash Cycle	Hard Water/ Heavy Soil	Medium Water/ Medium Soil	Soft Water/ Little Soil
Heavy	3 tbsp (45 ml)	3 tbsp (45 ml)	1.75-3 tbsp (25-45 ml)
Auto	1.75-3 tbsp (25-45 ml)	1.75 tbsp (25 ml)	1-1.75 tbsp (15-25 ml)
Normal	1.75-3 tbsp (25-45 ml)	1.75 tbsp (25 ml)	1-1.75 tbsp (15-25 ml)
Rinse	None	None	None

To Close:

- Place finger as shown in **Figure 4**.
- Slide door closed and press down firmly until it clicks.

Figure 4

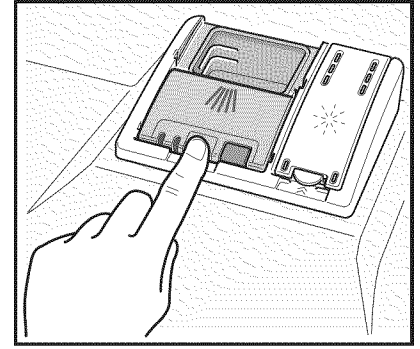

To Open:

- To open the cover, push the button as shown in **Figure 5**.
- Cover will slide open.

Figure 5

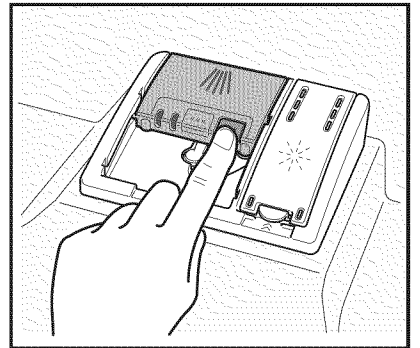

Rinse Aid

To achieve proper drying, always use a liquid rinse aid, even if your detergent contains a rinse aid or drying additive.

Note: The dishwasher indicates low rinse aid by turning on the “Refill Rinse Aid” LED in the display. If this light is on, you need to refill the rinse aid dispenser by following the directions below.

Adding Rinse Aid

NOTICE

To avoid oversudsing or clogging, do not overfill the rinse aid dispenser. Wipe up any spills with a damp cloth.

- 1 Add liquid rinse aid to the dispenser until it is full (see **Figure 6**). Do not overfill.
- 2 Close the lid. **Lid must be fully closed until it clicks in order to seal.**
- 3 Wipe up any excess rinse aid that may have puddled when the dispenser reservoir is full.

The indicator light will go out a few moments after the dishwasher door is shut. See page 16 for instructions on how to adjust the amount of rinse aid dispensed.

Figure 6

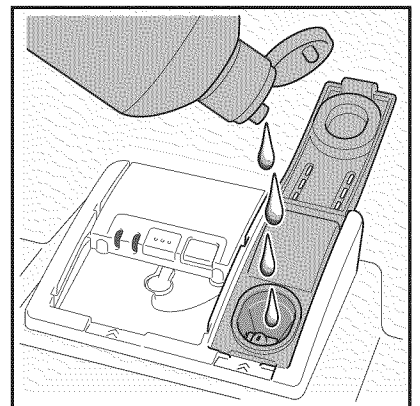

Dishware Materials

Note: Before using your dishwasher for the first time, check the information in this section. Some items are not dishwasher safe and should be hand washed; others require special loading.

Recommended

Aluminum: Colored anodized aluminum may fade over time. Minerals in your water may cause the aluminum to darken or spot. This can usually be removed with a soap-filled steel wool pad.

China, Crystal, Stoneware: Some hand-painted utensils may discolor, fade or spot. Hand wash these utensils. Position fragile glassware so that it will not fall over or come in contact with other utensils during the wash cycle.

Glass: Milk glasses may discolor or become yellow.

Non-stick Coatings: Apply a light coating of vegetable oil to non-stick surfaces after drying.

Plastics: Make sure the plasticware is dishwasher safe.

Stainless Steel, Sterling Silver and Silver Plates: Load these so they do not come in contact with other metals.

Not Recommended

Acrylic: crazing, small cracks throughout the acrylic, may occur.

Adhesive-Joined Pieces: Adhesives that join materials such as plastic, wood, bone, steel, copper, tin, etc. may loosen.

Bone-Handled Utensils: Handles may separate.

Iron: Iron will rust. Hand wash and dry immediately.

Non-Dishware Items: Your dishwasher is intended for use in cleaning ONLY standard household dishware and kitchenware.

Pewter, Brass, Bronze: These items will tarnish. Hand wash and dry immediately.

Tin: Tin will stain. Hand wash and dry immediately.

Wood: Wooden bowls, wooden utensils and utensils with wooden handles can crack, warp and lose their finish.

Loading the Dishwasher

Do not pre-wash items with loosely attached soiling. Remove all food particles, bones, toothpicks and excessive grease. Items having burned-on, baked-on or starchy soils may require some pretreatment. Refer to the Dishware Materials section for more information about dishware suitability.

Load only dishwasher safe items into the dishwasher. Load dishes in the dishwasher racks so the insides of bowls, pots and pans are facing the spray arms as shown. Avoid nesting and contact points between dishes. Separate items of dissimilar metals. Use care to not block movement of the spray arms.

WARNING

The sharp points and edges of knives and other sharp utensils can cause serious injuries. Load knives and other sharp utensils with edges down. Do not allow children to handle or play near knives and sharp utensils.

NOTICE

To avoid dishwasher damage, do not load the dishwasher with paper products, plastic bags, packing materials or anything other than normal, dishwasher safe dishware and kitchenware.

Loading the Upper Rack

Ensure items do not protrude through the bottom of the racks and block the spray arms.

Note: When pushing the upper rack into the dishwasher, push it until it stops against the back of the tub so the upper rack spray arm connects to the water supply at the back of the tub. Do not push racks in using the door.

Loading the Lower Rack

Place large items in the lower rack. Load pots, pans and bowls upside down. Do not block vent with tall baking sheets. Load these items on the right side of the dishwasher.

Unloading the Dishwasher

When unloading the dishwasher, it is recommended to unload the lower rack first. Next, unload the silverware basket followed by the upper rack. This prevents water from dripping down onto dishware.

Note: Dishes are more likely to chip when unloading before cooling.

Suggested Loading Pattern

Upper Rack

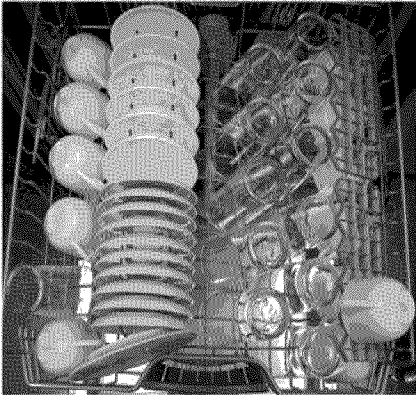

Lower Rack

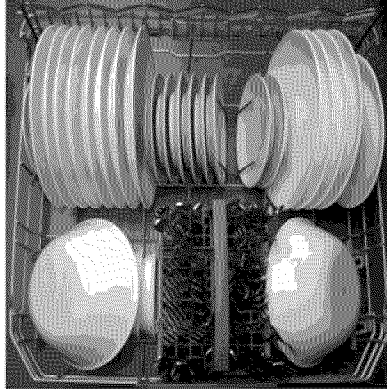

Cutlery Basket

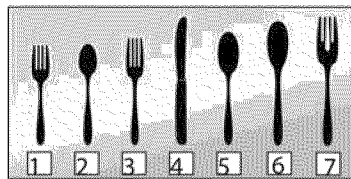
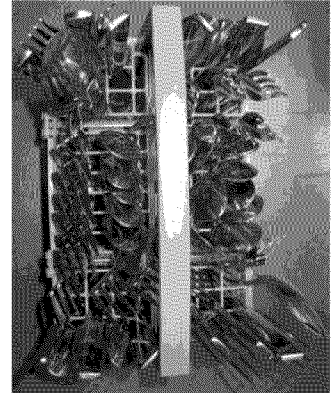

- 1- Salad fork
- 2- Teaspoon
- 3- Dinner fork
- 4- Knife
- 5- Tablespoon
- 6- Serving spoon
- 7- Serving fork

Silverware Basket

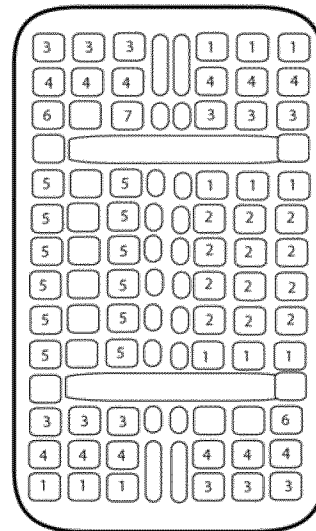

Additional Loading Pattern

Upper Rack

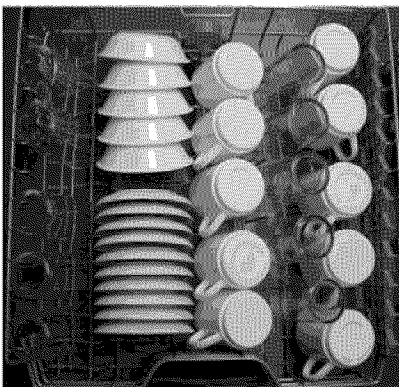

Lower Rack

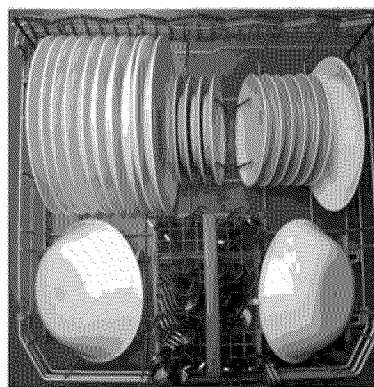

Cutlery Basket

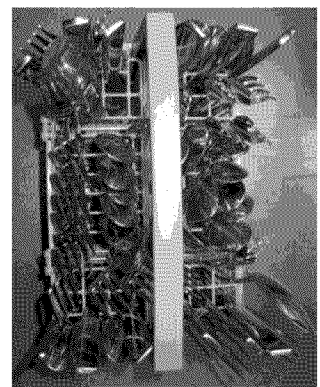

Rack Features

Flip Tines

The upper and lower racks consist of tines that can be folded down depending on what you may need to load in the rack. To fold down, grasp the folding tine and release from notch. Push folding tine downward to desired position as shown in **Figure 7**.

Figure 7

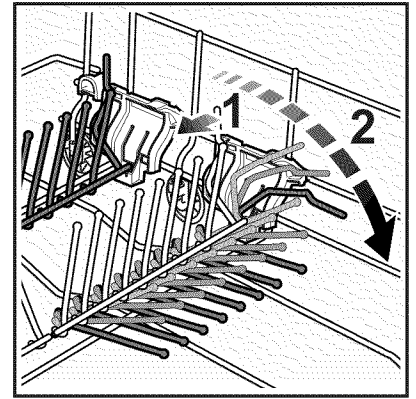

RackMatic®

The height of the upper rack can be adjusted in 3 positions to create more space (see **Figure 8**).

- 1 Pull the empty upper rack out of the dishwasher until it stops.
- 2 To lower the rack, push the lever inward then upward.
- 3 To raise, hold the empty rack by the sides and lift up.

Figure 8

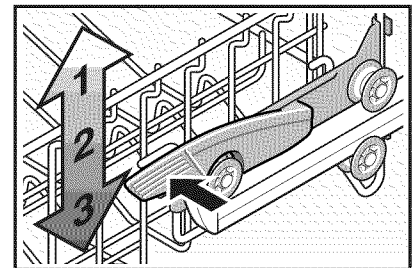

Plastic Item Clips

Light-weight plastic accessories (cups, lids, etc.) can be held securely by the plastic item clips (see **Figure 9**).

Figure 9

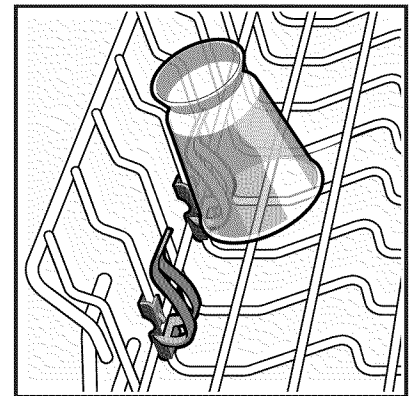

Cup Shelves

The shelf and the space underneath can be used for cups or for larger serving utensils (see **Figure 10**).

Figure 10

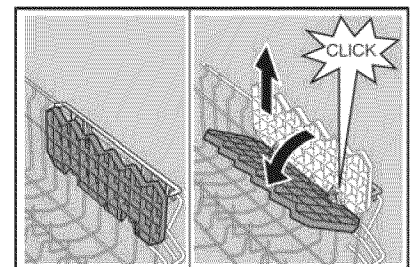

Dishwasher Cycles and Options

Wash Cycles

Note: In order to save energy, it is recommended to set the “Auto Power Off” feature to “P:01” (see the “Auto Power Off” section of this manual).

Heavy: Best for cleaning items with baked-on food or grease. These dishes would normally require soaking.

Auto: This is the most flexible cycle. With our most complex soil sensing capability, this cycle is perfect for use with mixed loads of dishware with varying amounts of food soil.

Normal: The Normal cycle is recommended for daily, regular, or typical use to completely wash a full load of normally soiled dishes.

In order to obtain optimal performance with minimum energy consumption, it is recommended to disable all available features except Auto Power Off as noted at the start of this section.

Note 1: See footnote for additional energy test setup instructions.

Rinse: Allows you to rinse food soil off of a partial load and hold them in the dishwasher until you are ready to run a full load.

Wash Cycle Options

Delay Start: Allows you to delay the start time of your dishwasher in one hour increments up to 24 hours.

Delicate: Available only in the Heavy, Auto and Normal cycles. This option’s lower temperature will reduce the risk of cloudy glasses.

Sanitize: The Sanitize feature is available only in the Heavy, Auto and Normal cycles. Select one of these cycles, press the “Sanitize Option” button and then press Start to activate the Sanitation features. The sanitize LED will light when sanitation requirements are met. The technical sanitation measures may also improve the drying results.

Note: The dishwasher automatically defaults to Auto when turned off and back on. If you used the sanitize option in your last cycle, the dishwasher will default to Auto with the Sanitize option selected when you turn it on.

Extra Shine®: Used in combination with a wash cycle (except Rinse), the Extra Shine® option raises the temperature and extends the drying time to further enhance drying results and provides a brilliant shine.

Note 1: The Energy Guide label was based on the Normal or Regular soil sensing cycle as follows: The unit was tested without any Rinse Aid (liquid) in the Rinse Aid chamber. A single dose of detergent was inserted into the Detergent Dispenser, with no detergent being used in the prewash. The unit was not subjected to truncated testing per the definitions in the test procedure. We recommend that dish loads such as the one in the energy certification test have the rack position set in the highest position.

Wash Cycle Information

The cycle times in this Use and Care Manual are based on normal soil loads and 120°F incoming water and will vary based on your actual conditions.

Table 3 - Wash Cycle Information

	Heavy	Auto	Normal	Rinse
cycle time	110-135 min	105-129 min	130-135 min	9 min
water consumption	18.6-24.2 L 4.9-6.4 gal	13.1-24.5 L 3.5-6.5 gal	8.3-20.6 L 2.2-5.4 gal	4.1 L 1.1 gal
wash temperature	66-71°C 150-160°F	53-66°C 127-150°F	45-55°C 113-131°F	incoming incoming
rinse temperature	72°C 162°F	70°C 158°F	62-69°C 144-156°F	incoming incoming
Delicate				
cycle time	105-110 min	90-105 min	105-120 min	n/a
water consumption	18.6-24.2 L 4.9-6.4 gal	13.1-24.5 L 3.5-6.5 gal	8.3-20.6 L 2.2-5.4 gal	n/a
rinse temperature	60°C 140°F	60°C 140°F	60°C 140°F	n/a
Sanitize				
cycle time	130-150 min	125-150 min	140-155 min	n/a
water consumption	18.6-24.2 L 4.9-6.4 gal	13.1-24.5 L 3.5-6.5 gal	8.3-20.6 L 2.2-5.4 gal	n/a
rinse temperature	72°C 162°F	72°C 162°F	72°C 162°F	n/a
Extra Shine®				
cycle time	130-150 min	125-150 min	140-155 min	n/a
water consumption	18.6-24.2 L 4.9-6.4 gal	13.1-24.5 L 3.5-6.5 gal	8.3-20.6 L 2.2-5.4 gal	n/a
rinse temperature	72°C 162°F	72°C 162°F	72°C 162°F	n/a

Note: Only sanitizing cycles have been designed to meet the requirements of Section 6 of the NSF/ANSI Standard for Residential Equipment for soil removal and sanitization efficacy. There is no intention, either directly or indirectly, to imply that all cycles have passed sanitization performance tests.



Operating the Dishwasher

SGE53U5xUC*

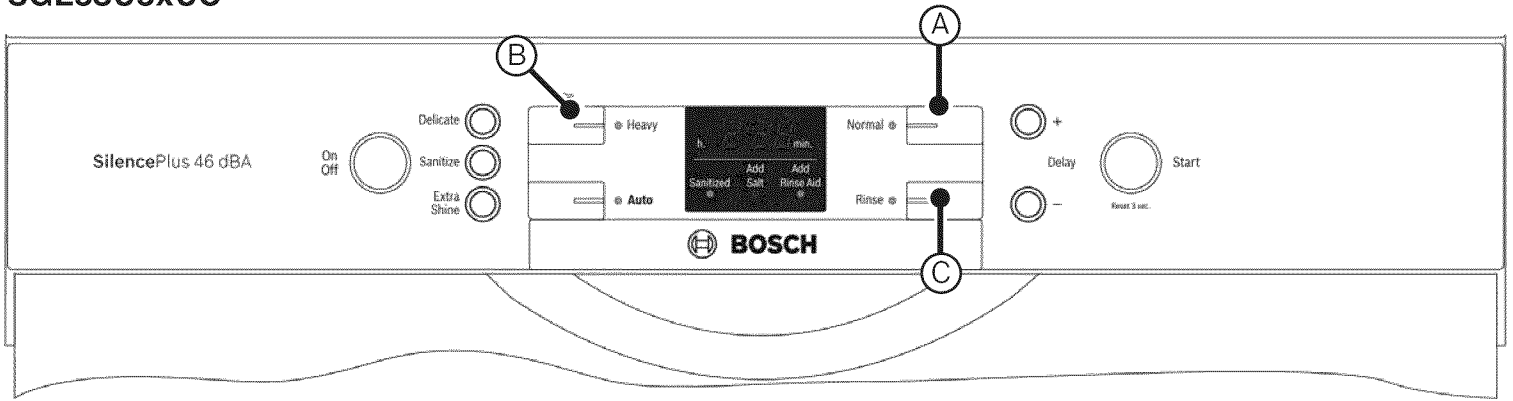

* x can be any number

NOTE: The door must be opened before changing settings and closed after changing settings.

Buttons are sensitive and should be touched gently. Avoid any grease or food particles resting on the buttons as they could activate the dishwasher. Wiping and cleaning can also activate the dishwasher. For best results, use bare, clean hands when touching the buttons.

WARNING

To avoid risk of injury, always use caution when opening the door during or following a wash cycle as hot water or steam may escape. Do not fully open the door until water noises have stopped and steam has subsided.

Start the dishwasher

- 1 Press the **[On/Off]** button.
- 2 Select a cycle and desired options and press **[Start]**.

Cancel a Cycle

- 1 Press and hold the **[Start]** button for approximately 3 seconds until the display reads **"0:01"**.
- 2 Wait about 1 minute while the dishwasher drains.
- 3 Press the **[On/Off]** button.

Interrupt a Cycle

- 1 Press the **[On/Off]** button to turn the unit off.
- 2 To resume the cycle, press the **[On/Off]** button.

Setting the Amount of Rinse Aid

The amount of rinse aid dispensed can be set from “r:00” to “r:06”.

To change the setting:

- 1 Press the **[On/Off]** button.
- 2 Hold down the “**A**” button (see page 15) and press **[Start]** until the display indicates “**H:0x**” (x can be any number).
- 3 Release both buttons.
- 4 Press the “**A**” button until the display shows “**r:05**”.
- 5 Press the “**C**” button to select the desired setting.
 - “**r:00**” = dispenser is OFF
 - “**r:01**” = lowest setting
 - “**r:02**” = low setting
 - “**r:03**” = medium setting
 - “**r:04**” = medium/high setting
 - “**r:05**” = high setting
 - “**r:06**” = highest setting
- 6 Press **[Start]** to save the setting.

Delay Start

You can delay the start of the cycle in one hour increments up to 24 hours.

To set delay start:

- 1 Press the **[On/Off]** button.
- 2 Press the **[+]** button until the display jumps to “**h:01**”.
- 3 Press the **[+]** or **[-]** button until the displayed time corresponds with your requirements.
 - h:01** = 1 hour delay
 - h:24** = 24 hour delay
- 4 Press **[Start]** to activate delay start.

To cancel delay start:

- 1 Press the **[+]** or **[-]** button until “**h:00**” is indicated on the digital display.
- 2 Press and hold **[Start]** for 3 seconds to cancel the cycle. You may now start a new cycle.

Auto Power Off

To save energy, the dishwasher is turned off 1 minute after the wash cycle ends. Auto Power Off can be adjusted from P:00 to P:02.

To change the setting:

- 1 Press the **[On/Off]** button.
- 2 Hold down the “**A**” button (see page 15) and press **[Start]** until the display indicates “**H:0x**” (x can be any number).
- 3 Release both buttons.
- 4 Press the “**A**” button until the display indicates “**P:0x**”.
- 5 Press the “**C**” button until the display corresponds with your requirements.
 - P:00** = dishwasher does not turn off automatically
 - P:01** = dishwasher turns off automatically after 1 minute
 - P:02** = dishwasher turns off automatically after 120 minutes (2 hours)
- 6 Press **[Start]** to save the setting.

Child Lock

- 1 Start the desired cycle.
 - 2 Hold down the button that says “Child Lock” underneath it for approximately 3 seconds until the display reads “**CL**”.
 - 3 The “**CL**” will be indicated now if any button is pressed and the program will not be reset.
- To deactivate the child lock, hold down the “Child Lock” button for approximately 3 seconds until the display no longer reads “**CL**”.

AquaStop® Leak Protection

Our AquaStop® system contains leaks through a precisely engineered tub and sensor system that works with our solid molded base. If a leak has occurred, it shuts down operation and automatically pumps out water to avoid contact with the floor. It works 24/7 and can turn itself on.

Care and Maintenance

A regular inspection and maintenance of your machine will help to prevent faults. This saves time and prevents future problems.

Overall condition of the machine

Never use a steam cleaner to clean your dishwasher. The manufacturer is not responsible for any consequential damage.

Regularly wipe the front of the appliance with a damp cloth - water and a small amount of liquid soap is adequate. Do not use sponges with a rough surface or abrasive detergents, as these could scratch the surfaces.

Stainless steel appliances: To prevent corrosion, avoid using sponge cloths or chlorine based cleaners. Use a stainless steel polish to seal and protect the surface.

Clean the outer edges of the inside door panel regularly to remove debris that may collect from normal loading. If spots begin to appear on the stainless steel, make sure the rinse agent is full and functioning properly.

WARNING

Use caution when removing parts for cleaning as some debris may be sharp.

Filters

The filter system consists of a coarse filter, a flat fine filter and a micro filter. The filters keep large foreign objects in the rinsing water away from the pump. Foreign objects may occasionally block the filters.

Check the filters for residue by:

- Unscrew the filter cylinder as illustrated in **Figures 11-12** and take out the filter system.
- Remove any residue and clean filters under running water.
- Reinstall filter system in reverse sequence and ensure that the arrow marks are facing each other after locking it into place.

Figure 11

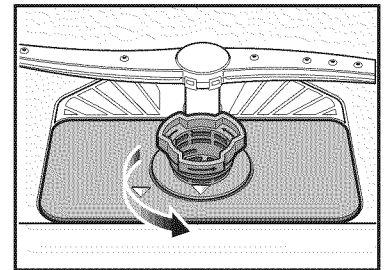

Figure 12

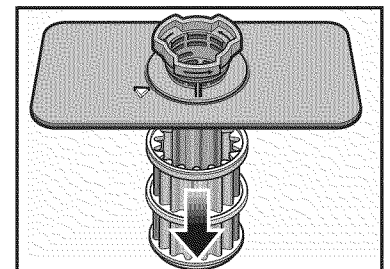
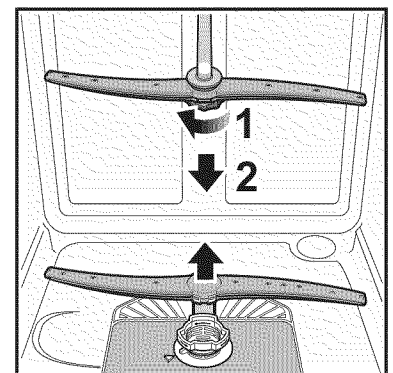

Figure 13



Spray Arms

Check spray arms for grease and limescale deposits.

If you find such deposits:

- Fill detergent dispenser with detergent and start the appliance without utensils in the cycle with the highest rinsing temperature (see wash cycle information table).
- Clean the appliance with detergents/ appliance cleaners which are particularly suitable for use with dishwashers.
- Unscrew the spray arms and inspect as shown in **Figure 13**.

Drain Pump

Large food remnants in the rinsing water not retained by the filters may block the drain pump. The rinsing water does not get pumped out and covers the filters.

In this case:

- Disconnect the appliance from the power supply.
- Remove the filters.
- Scoop out standing water - use a sponge if necessary.
- Using a spoon, pry off the pump cover (see **Figures 14-15**) until it clicks, then grip the cover and pull upward until it resists and then pull forward.
- Check inner compartment and remove any foreign objects.
- Place cover in the original position, press down and engage.
- Reinstall filters.

Figure 14

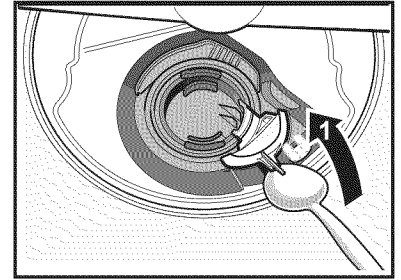
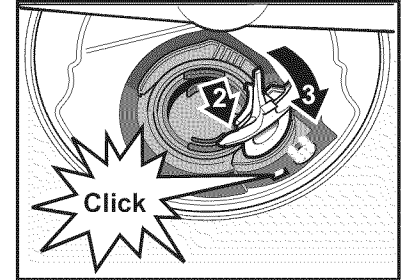

Figure 15



NOTICE

Preparing your Dishwasher for Vacation

Before leaving for vacation during warmer weather, besides turning off the main valve, also turn off water supply at the nearest point to the dishwasher. During colder weather, please follow the instructions for winterizing your unit below.

NOTICE

Winterizing your Dishwasher

If your dishwasher will be unused for an extended period of time in a location that experiences freezing temperatures (holiday home or through a vacation period), have your dishwasher winterized by a professional servicer.

Troubleshooting Guide

Dishwashers may occasionally exhibit problems that are unrelated to a malfunction of the dishwasher itself. The following information may help you with a dishwasher problem without involving a repair professional.

Problem	Cause	Action
Dishwasher does not start	<ol style="list-style-type: none"> 1. Door may not be properly latched. 2. Unit may not be turned on. 3. Unit not reset or previous cycle not completed. 4. Delay start engaged. 5. Interruption of electrical power supply to dishwasher or blown fuse. 6. The door may have been closed without first selecting a cycle. 7. Water supply may not be turned on. 	<ol style="list-style-type: none"> 1. Shut the door completely. 2. Press the main power switch to turn unit on. 3. To reset, refer to “Operating the Dishwasher” in this manual. 4. To reset, refer to “Delay Start” section in this manual. 5. Check circuit breaker. 6. Select a cycle and press start. 7. Check and turn on water supply.
Dishwasher beeping (end of cycle signal)	<ol style="list-style-type: none"> 1. Default factory settings alert the customer that the cycle is complete by beeping. This feature can be deactivated if so desired. 2. Water connection is lost. 	<ol style="list-style-type: none"> 1. To adjust the volume or deactivate, refer to the “Cycle Completion Signal” section in this manual. 2. Check and turn on water supply.
Display does not illuminate or console lights are not on	<ol style="list-style-type: none"> 1. A fuse may have been blown or circuit breaker tripped. 2. Door not closed or latched. 	<ol style="list-style-type: none"> 1. Check the fuse or circuit breaker box and replace the fuse or reset the breaker if necessary. 2. Ensure door is properly latched and completely closed.
Dishwasher seems to run a long time	<ol style="list-style-type: none"> 1. Incoming water is not warm enough. 2. Cycle time can vary due to soil and water conditions. 3. Rinse aid dispenser is empty. 4. Dishwasher connected to cold water supply. <p><i>Note: Refer to “Wash Cycle Information” section in this manual for typical cycle lengths.</i></p>	<ol style="list-style-type: none"> 1. Before starting a cycle, run hot water faucet at the sink closest to the dishwasher. 2. Sensors in the dishwasher automatically increase the cycle time to ensure a good wash when heavy soil is detected. 3. Add rinse aid. 4. Verify dishwasher is connected to hot water supply plumbing.
Dishes are not getting clean enough	<ol style="list-style-type: none"> 1. Spray arm movement obstructed. 2. Spray arm nozzles clogged. 3. Improper use of detergents. 4. Filters could be clogged. 5. Dishes are nested or loaded too close together. 6. Selected wash cycle is not suitable for food soil conditions. 	<ol style="list-style-type: none"> 1. Ensure that spray arm movement is not blocked by hand rotating spray arms before starting cycle. 2. Remove the spray arms and clean according to the “Care and Maintenance” section of the manual. 3. Increase or decrease detergent depending on the water hardness (refer to Table 1). 4. Clean the filters according to the “Care and Maintenance” section of the manual. 5. Rearrange load such that water spray can reach all items in the dishwasher - see “Loading the Dishwasher” section of the manual. 6. Refer to “Wash Cycle Information” section of the manual.

Problem	Cause	Action
Dishes are not getting dry enough	<ol style="list-style-type: none"> 1. Rinse aid dispenser is empty. 2. Improper loading of dishes. 3. Selected cycle does not include drying. <p><i>Note: Plastic or Teflon do not typically dry as well as other items due to their inherent properties.</i></p>	<ol style="list-style-type: none"> 1. Add rinse aid - the use of rinse aid improves drying. 2. Rearrange load to ensure items are not nesting (see “Loading the Dishwasher” section of the manual). 3. Rinse and Hold setting does not include drying. <p><i>Note: Sanitize option and Intensive Drying feature also improve drying performance.</i></p>
Odor <i>Note: Water testing is done in the factory. Occasionally water may still appear in the dishwasher at purchase which may create an odor.</i>	<ol style="list-style-type: none"> 1. Food debris is present at the bottom of the dishwasher. 2. Food particles are present near the door seal. 3. Dishes left in unit too long before running a cycle. 4. Residual water is present at the bottom of the dishwasher. 5. Drain hose is obstructed. 	<ol style="list-style-type: none"> 1. Remove the filters and clean according to the “Care and Maintenance” section of the manual. 2. Refer to “Care and Maintenance” section of the manual. 3. Run a Rinse cycle if you do not intend to immediately wash the dishes. 4. Ensure the unit has completely drained from the last cycle. 5. Remove any obstructions from the drain hose by calling qualified personnel. <p><i>Note: If odor still persists, run the Normal cycle until it flushes and interrupt the cycle and place an 8 oz. cup of distilled white vinegar solution on the upper rack and then finish the cycle.</i></p>
Dishwasher not filling with water	<ol style="list-style-type: none"> 1. Restriction in the water supply system. 2. Previous wash cycle was not completed. 3. Delay start is active. 	<ol style="list-style-type: none"> 1. Ensure that the water supply valve (typically located under kitchen sink) is open and check that the water supply line has no kinks or clogs. 2. Refer to the “Operating the Dishwasher” section of the manual. 3. Cancel the delay start or wait until delay start time completes.
Water leaks	<ol style="list-style-type: none"> 1. Suds. 2. Door seal could be pulled away from track. 3. Condensation vent is blocked. 4. Improper installation. 	<ol style="list-style-type: none"> 1. Wrong type of detergent results in suds and leaks - use only dishwasher detergents. If suds still persist, add one tablespoon of vegetable oil at the bottom of the dishwasher and run the desired cycle. 2. Ensure the door seal is in the track. 3. Ensure that condensation vent is not blocked. 4. Have proper installation verified by qualified personnel (water supply, drain system, leveling, plumbing).
Tub stains	<ol style="list-style-type: none"> 1. Stains on the dishwasher interior are due to water hardness. 2. Silverware in contact with tub. 	<ol style="list-style-type: none"> 1. Concentrated lemon juice can reduce the build up of hard water stains. Run a Normal cycle until it flushes and interrupt the cycle and then place an 8 oz. cup of the concentrated lemon solution on the upper rack and finish the cycle. This can be done periodically to avoid build up. 2. Ensure that silverware does not make contact with the tub while running a cycle.

Problem	Cause	Action
Streaks on glassware or residue on the dishes	1. Incorrect rinse agent setting.	1. Depending on the hardness of water, adjust the rinse agent dispenser. Refer to “Dishwasher Setup” section in the manual.
Fascia panel discolored or marked	1. Abrasive cleaner used.	1. Use mild detergents with soft damp cloth.
Noise during wash cycle	1. Dishes may not be arranged properly.	1. Water circulation sound is normal, but if you suspect items are banging into each other or into the spray arms, refer to the “Loading the Dishwasher” section of the manual for optimal arrangement.
Detergent dispenser cover will not shut	1. Improper operation of detergent cover. 2. Previous cycle has not finished and should be interrupted or cancelled.	1. Refer to “Detergent” section of the manual for instructions on opening and closing the dispenser. 2. Refer to the “Operating the Dishwasher” section of the manual.
Unable to select desired cycle	1. Previous cycle has not finished.	1. Refer to the “Operating the Dishwasher” section of the manual.

Customer Service

Your Bosch® dishwasher requires no special care other than that described in the Care and Maintenance section of this manual. If you are having a problem with your dishwasher, before calling for service please refer to the Troubleshooting Guide section of the manual. If service is necessary, contact your dealer or installer or an authorized service center. Do not attempt to repair the appliance yourself. Any work performed by unauthorized personnel may void the warranty.



If you are having a problem with your Bosch® dishwasher and are not pleased with the service you have received, please take the following steps until the problem is corrected to your satisfaction:

- 1 Call us at 1-800-944-2904
- 2 Contact Customer Service from our web site:
www.bosch-home.com/us or www.bosch-home.ca
- 3 Contact your installer or the Bosch Authorized Service Contractor in your area.
- 4 Write us:

BSH Home Appliances Corporation
1901 Main Street, Suite 600
Irvine, CA 92614

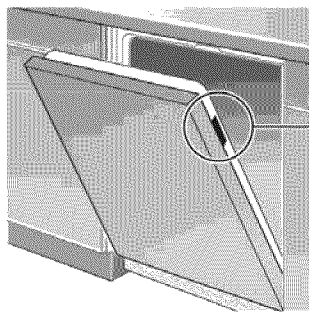
Please be sure to include your model information as well as an explanation of the problem and the date it started. You will find the model and serial number information on the label located on the edge of the dishwasher door. Please make a copy of your invoice and keep it with this manual. Customer Service may need to verify purchase date for warranty purposes.



BOSCH Cust. Service (SERVICE CLIENTÈLE): 1-800-944-2904		 C US LISTED (LISTÉ)	 Residential (RÉSIDENTIEL)	 ENERGY VERIFIED BY EMERGETICS VÉRIFIÉ PAR EP3152762
MODEL NUMBER (NUMÉRO DE MODÈLE) SH#####UC/06 FD910300001	120 V 12,0 A 60 Hz 0,2 kW 1,2 kW Made in the USA of US and imported parts (Fabriqué aux É.-U. de pièces É.-U. et importées)			
SN6P5B	10103098989100011	76x6 DISHWASHER (LAVE-VAISSELLE) E103022 Certified residential dishwashers are not intended for licensed food establishments. Les lave-vaisselle résidentiels certifiés ne sont pas destinés aux établissements alimentaires agréés.		



STATEMENT OF LIMITED PRODUCT WARRANTY

What this Warranty Covers & Who it Applies to: The limited warranty provided by BSH Home Appliances (“Bosch”) in this Statement of Limited Product Warranty applies only to the Bosch appliance sold to you, the first using purchaser, provided that the Product was purchased:

- For your normal, household use, and has in fact at all times only been used for normal household purposes.
- New at retail (not a display, “as is”, or previously returned model), and not for resale.
- Commercial Use such as office space, multi-housing properties (apartments, time-shares, etc.), and Hotel/Motel suites. (Any type of industrial/restaurant use is not covered).
- Within the United States or Canada, and has at all times remained within the country of original purchase.

The warranties stated herein apply only to the first purchaser of the Product and are not transferable. Please make sure to return your registration card; while not necessary to effectuate warranty coverage, it is the best way for Bosch to notify you in the unlikely event of a safety notice or product recall.

How Long the Warranty Lasts: Bosch warrants that the Product is free from defects in materials and workmanship for a period of three hundred and sixty-five (365) days from the date of purchase. The foregoing timeline begins to run upon the date of purchase, and shall not be stalled, tolled, extended, or suspended, for any reason whatsoever. This Product is also warranted to be free from cosmetic defects in material and workmanship (such as scratches of stainless steel, paint/porcelain blemishes, chip, dents, or other damage to the finish of the Product), for a period of thirty (30) days from the date of purchase or closing date for new construction. This cosmetic warranty excludes slight color variations due to inherent differences in painted and porcelain parts, as well as differences caused by kitchen lighting, product location, or other similar factors. This cosmetic warranty specifically excludes any display, floor, “As Is”, or “B” stock appliances.

Repair/Replace as Your Exclusive Remedy: During this warranty period, Bosch or one of its authorized service providers will repair your Product without charge to you (subject to certain limitations stated herein) if your Product proves to have been manufactured with a defect in materials or workmanship. If reasonable attempts to repair the Product have been made without success, then Bosch will replace your Product (upgraded models may be available to you, in Bosch's sole discretion, for an additional charge). All removed parts and components shall become the property of Bosch at its sole option. All replaced and/or repaired parts shall assume the identity of the original part for purposes of this warranty and this warranty shall not be extended with respect to such parts. Bosch's sole liability and responsibility hereunder is to repair manufacturer-defective Product only, using a Bosch authorized service provider during normal business hours. For safety and property damage concerns, Bosch highly recommends that you do not attempt to repair the Product yourself, or use an un-authorized servicer; Bosch will have no responsibility or liability for repairs or work performed by a non-authorized servicer. If you choose to have someone other than an authorized service provider work on your Product, THIS WARRANTY WILL AUTOMATICALLY BECOME NULL AND VOID. Authorized service providers are those persons or companies that have been specially trained on Bosch products, and who possess, in Bosch's opinion, a superior reputation for customer service and technical ability (note that they are independent entities and are not agents, partners, affiliates or representatives of Bosch). Notwithstanding the foregoing, Bosch will not incur any liability, or have responsibility, for the Product if it is located in a remote area (more than 100 miles from an authorized service provider) or is reasonably inaccessible, hazardous, threatening, or treacherous locale, surroundings, or environment; in any such event, if you request, Bosch would still pay for labor and parts and ship the parts to the nearest authorized service provider, but you would still be fully liable and responsible for any travel time or other special charges by the service company, assuming they agree to make the service call.

Out of Warranty Product: Bosch is under no obligation, at law or otherwise, to provide you with any concessions, including repairs, prorates, or Product replacement, once this warranty has expired.

Warranty Exclusions: The warranty coverage described herein excludes all defects or damage that are not the direct fault of Bosch, including without limitation, one or more of the following:

- Use of the Product in anything other than its normal, customary and intended manner (including without limitation, use or storage of an indoor product outdoors, use of the Product in conjunction with air or water-going vessels).
- Any party's willful misconduct, negligence, misuse, abuse, accidents, neglect, improper operation, failure to maintain, improper or negligent installation, tampering, failure to follow operating instructions, mishandling, unauthorized service (including self performed “fixing” or exploration of the appliance's internal workings).
- Adjustment, alteration or modification of any kind.
- A failure to comply with any applicable state, local, city, or county electrical, plumbing and/or building codes, regulations, or laws, including failure to install the product in strict conformity with local fire and building codes and regulations.
- Ordinary wear and tear, spills of food, liquid, grease accumulations, or other substances that accumulate on, in, or around the Product.
- Any external, elemental and/or environmental forces and factors, including without limitation, rain, wind, sand, floods, fires, mud slides, freezing temperatures, excessive moisture or extended exposure to humidity, lightning, power surges, structural failures surrounding the appliance, and acts of God.

In no event shall Bosch have any liability or responsibility whatsoever for damage to surrounding property, including cabinetry, floors, ceilings, and other structures or objects around the Product. Also excluded from this warranty are Products on which the serial numbers have been altered, defaced, or removed; service visits to teach you how to use the Product, or visits where there is nothing wrong with the Product; correction of installation problems (you are solely responsible for any structure and setting for the Product, including all electrical, plumbing or other connecting facilities, for proper foundation/flooring, and for any alterations including without limitation cabinetry, walls, floors, shelving, etc.); and resetting of breakers or fuses.

TO THE EXTENT ALLOWED BY LAW, THIS WARRANTY SETS OUT YOUR EXCLUSIVE REMEDIES WITH RESPECT TO PRODUCT, WHETHER THE CLAIM ARISES IN CONTRACT OR TORT (INCLUDING STRICT LIABILITY, OR NEGLIGENCE) OR OTHERWISE. THIS WARRANTY IS IN LIEU OF ALL OTHER WARRANTIES, WHETHER EXPRESS OR IMPLIED. ANY WARRANTY IMPLIED BY LAW, WHETHER FOR MERCHANTABILITY OR FITNESS FOR A PARTICULAR PURPOSE, OR OTHERWISE, SHALL BE EFFECTIVE ONLY FOR THE PERIOD THAT THIS EXPRESS LIMITED WARRANTY IS EFFECTIVE. IN NO EVENT WILL THE MANUFACTURER BE LIABLE FOR CONSEQUENTIAL, SPECIAL, INCIDENTAL, INDIRECT, “BUSINESS LOSS”, AND/OR PUNITIVE DAMAGES, LOSSES, OR EXPENSES, INCLUDING WITHOUT LIMITATION TIME AWAY FROM WORK, HOTELS AND/OR RESTAURANT MEALS, REMODELLING EXPENSES IN EXCESS OF DIRECT DAMAGES WHICH ARE DEFINITELY CAUSED EXCLUSIVELY BY BOSCH, OR OTHERWISE. SOME STATES DO NOT ALLOW THE EXCLUSION OR LIMITATION OF INCIDENTAL OR CONSEQUENTIAL DAMAGES, AND SOME STATES DO NOT ALLOW LIMITATIONS ON HOW LONG AN IMPLIED WARRANTY LASTS, SO THE ABOVE LIMITATIONS MAY NOT APPLY TO YOU. THIS WARRANTY GIVES YOU SPECIFIC LEGAL RIGHTS, AND YOU MAY ALSO HAVE OTHER RIGHTS WHICH VARY FROM STATE TO STATE.

No attempt to alter, modify or amend this warranty shall be effective unless authorized in writing by an officer of BSH.

BSH reserves the right to change specifications or design without notice. Some models are certified for use in Canada. BSH is not responsible for products which are transported from the United States for use in Canada. Check with your local Canadian distributor or dealer.

BSH se réserve le droit de modifier les données techniques ou le design sans préavis. Certains modèles sont certifiés pour une utilisation au Canada. BSH n'est pas responsable pour les produits transportés des États-Unis pour une utilisation au Canada. Vérifier auprès d'un marchand ou distributeur canadien.

BSH Home Appliances Corporation
1901 Main Street
Irvine, CA 92614

9000986246 (9501)

