

1. About Your Omni S2

1.1 What's in the Box

1.2 Overview

1.3 Button Controls

2. Preparing Your Omni S2

2.1 Install the Omni Station

2.2 Charge Your RoboVac

2.3 Download the App

2.4 Reset the Wi-Fi Connection

3. Using Your Omni S2

3.1 Important Tips Before Use

3.2 Mapping

3.3 Set Up No-Go Zone and No-Mop Zone

3.4 Schedule Cleaning

3.5 Select a Cleaning Mode

4. Using the Mopping System

5. Using RoboVac with Matter, Alexa, Siri, or Google Assistant Compatible Devices

6. Enabling / Disabling Child Safety Lock

7. Cleaning and Maintenance

7.1 Clean the Dust Bin

7.2 Replace the Rolling Mop

7.3 Clean the Rolling Brush

7.4 Clean the Sensors, Cameras, and Charging Contact Pins

7.5 Replace the Dust Bag

7.6 Clean the Filter Tray

7.7 Clean the Dirty Water Tank

8. Troubleshooting

9. Specifications

10. Customer Service

1. About Your Omni S2

1.1 What's in the Box



Omni Station



Clean Water Tank



Detachable Base



Robot Vacuum Cleaner
(RoboVac)



Dirty Water Tank



Water Tank Holder



Floor Cleaner



Fragrance Refill



Quick Start Guide



Safety Sheet



Power Cord

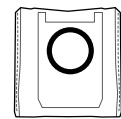

(Bonus)

Dust Bag

1.2 Overview

1.2.1 RoboVac

Front



- 1 RGB Camera
- 2 Recharge Button
 - Press to pause cleaning.
- 3 Dust Bin
- 4 Magnetic Cover
- 5 Fragrance Refill Cover
- 6 Start / Pause Button
 - Press to start / pause cleaning.
 - Press and hold for 3 seconds to power off;
 - Press and hold for 15 seconds to force shutdown.
- 7 Bumper
- 8 LED Light
- 9 3D dTOF Sensor

Back



- 1 Air Outlet
- 2 Charging Contact Pins (x2)
- 3 Dirty Water Collection Port
- 4 Water Injection Port

Dust Bin



- 1 Dust Bin Handle
- 2 Metal Filter
- 3 High-Performance Filter

Bottom

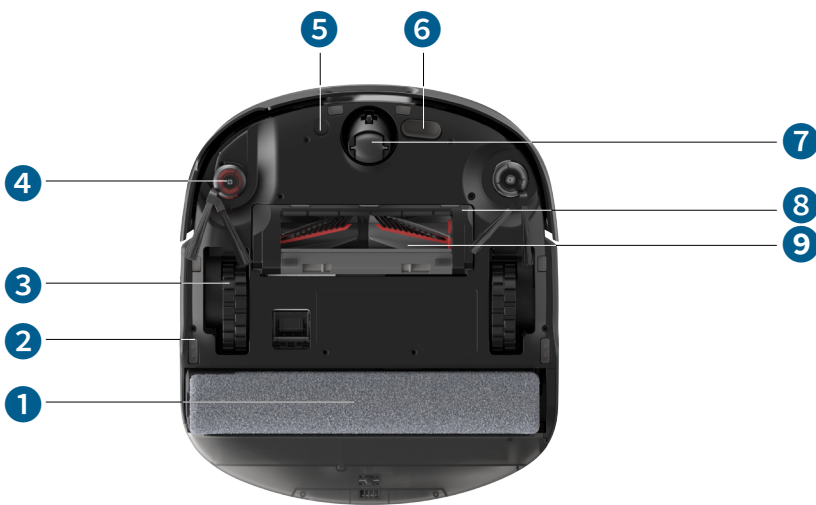

- 1 Rolling Mop
- 2 Drop Sensors (×6)
- 3 Wheels (×2)
- 4 Side Brushes (×2)
- 5 Carpet Detection Sensor
- 6 Optical Flow Sensor
- 7 Swivel Wheel
- 8 Brush Guard
- 9 DuoSpiral™ Brushes

1.2.2 Omni Station

Front









- 1 Detachable Base
- 2 Filter Tray
- 3 Slide Switch
 - Slide to open the dust bag cover.
- 4 Clean Water Tank
- 5 Clean Water Tank Cap
- 6 LCD Screen
- 7 Dirty Water Tank Release Button
 - Pull to open the dirty water tank cover.
- 8 Dirty Water Tank
- 9 Dust Bag

Back

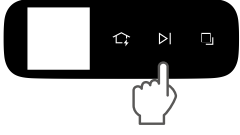

- 1 Cord Winding Groove
- 2 Power Socket

1.3 Button Controls

RoboVac		<ul style="list-style-type: none"> • Short press: pause cleaning • Short press again: return RoboVac to Omni Station
		<ul style="list-style-type: none"> • Short press: start / pause cleaning • Long press (3s): power off • Long press (15s): force shutdown
		<ul style="list-style-type: none"> • Long press simultaneously (3s): reset Wi-Fi connection • Long press simultaneously (10s): reset to factory settings
Omni Station		<ul style="list-style-type: none"> • Short press: return RoboVac to Omni Station
		<p>Short press:</p> <ul style="list-style-type: none"> • Start cleaning when the robot is idle or drying • Pause/Resume cleaning when a task is in progress • Continue the current task during dust collection or mop washing
		<ul style="list-style-type: none"> • Short press: switch between Vacuum Only mode and Vacuum/Mop mode

2. Preparing Your Omni S2

2.1 Install the Omni Station

1. Install the detachable base by pressing down firmly on both sides. Connect the power cord to the Omni Station and a wall outlet.

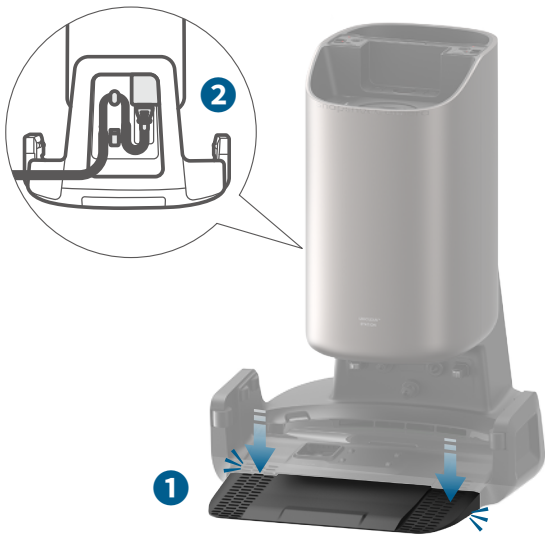

- 💡 • Always keep the Omni Station plugged in to ensure the connection between the robot and the Omni Station is successful; otherwise, the robot will not automatically return to it.

2. Connect the power cord to the Omni Station. Place the Omni Station in a location with a strong Wi-Fi signal and ensure the robot can easily access it. Make sure there is at least 1.5 meters of clearance in front and 0.5 meters on both sides on a hard, open floor. It is recommended to place it against a wall and on a hard, level surface.



- The recommended clearance on the illustration is a suggested value based on testing, to ensure the robot operates optimally, returns to the station for charging, and cleans the designated area effectively. You may adjust the clearance distance as necessary to suit the actual working environment of the robot.

3. Make sure the docking area between the Omni Station and the screen holder is dry and free of any water stains. Then, install and firmly press down the screen holder. Once installed, an animation will appear on the screen.



4. Peel off the seal from the opening and bottom of the floor cleaner, then insert the bottle into the cleaner slot. Make sure the floor cleaner is securely installed.



5. Make sure the dirty water tank cap is properly closed, and the latch clicks into place. Then, install the dirty water tank.

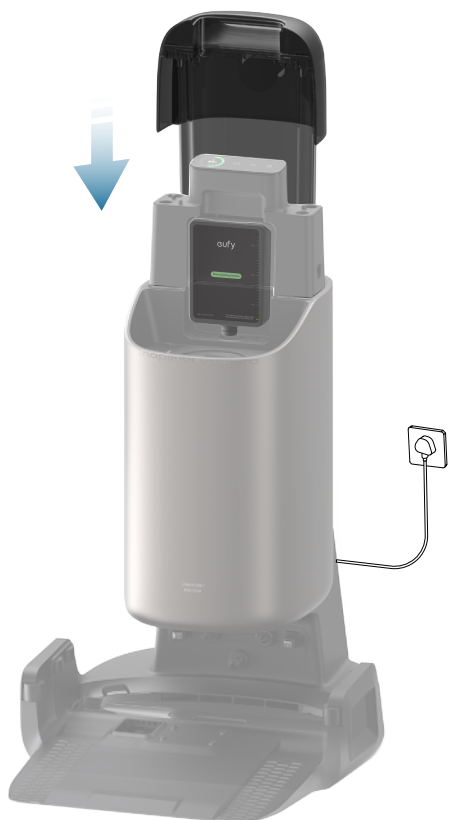

6. Add clean water to the clean water tank until it reaches the MAX water line, then install the clean water tank.



2.2 Charge Your RoboVac

1. Remove the foam blocks on RoboVac.



2. Open the top cover and the fragrance refill cover, then install the fragrance refill in the slot.

 • Follow the diagram below to install the fragrance refill.



3. Attach RoboVac to the Omni Station. RoboVac will power on and start charging automatically.



2.3 Download the App

To enjoy all the available features, it is recommended to download the app.

1. Download the app from the App Store (iOS devices) or Google Play (Android devices). You can also get the app by scanning the QR code printed on the Quick Start Guide (included in the package).
2. Open the app. Create a new account or log into your own eufy account.

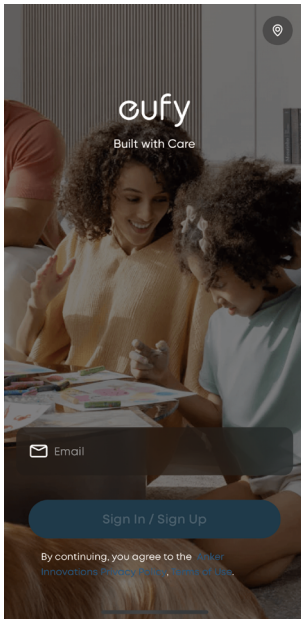

3. Tap the "+" icon to add the device.

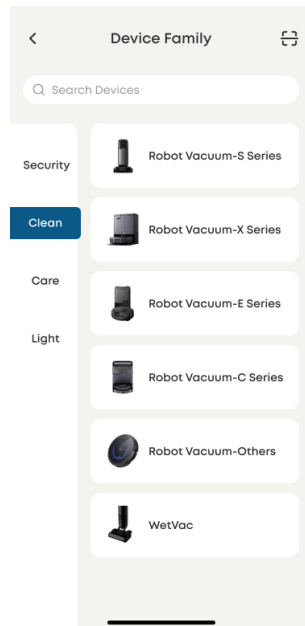
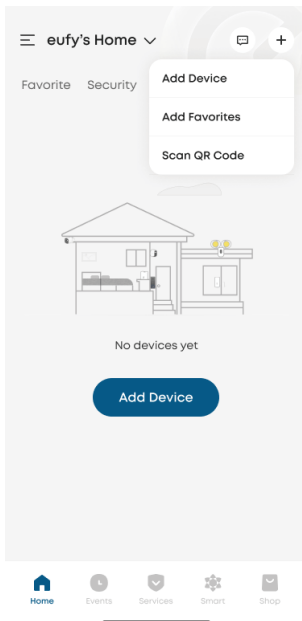

4. Follow the instructions in the app to set up the Wi-Fi connection.

2.4 Reset the Wi-Fi Connection

If you bump into issues when connecting your RoboVac to the app, try to reset the 2.4G Wi-Fi connection.

Press and hold the power and start / pause buttons simultaneously for 3 seconds until you hear a voice prompt.



You will hear a voice prompt when the Wi-Fi connection has been reset, and the LED indicators on RoboVac will quickly flash white. Now you can follow the instructions in the app to set up the Wi-Fi connection.

3. Using Your Omni S2

 • All UI images shown in this section are for illustration only, and they may be subject to change due to software updates. Please refer to the actual App interface for the most accurate information.

3.1 Important Tips Before Use

- Remove power cords and small objects from the floor that may entangle RoboVac.
- It is strongly recommended to place physical barriers or set a "No-Go" zone via the eufy app in front of fireplaces and certain areas (i.e. stairway) that may cause damage to RoboVac if entered.
- Avoid vacuuming large amounts of water as it will potentially damage the device.
- RoboVac may climb on top of objects less than 1.38 in / 35 mm in height. Remove these objects if possible.
- Anti-drop sensors will prevent RoboVac from tumbling down stairs and steep drops in most cases. Sensors are less effective if dirty or used on carpeted / reflective floors. It is recommended to regularly wipe the sensors and set no-go zones, especially around stairs or any areas where the robot might fall.

3.2 Mapping

This feature is designed to help your RoboVac efficiently learn the layout of your home, ensuring thorough and systematic cleaning. By creating a detailed floor plan, your RoboVac can navigate and clean with precision.

To maximize the efficiency and accuracy of the mapping process, please follow these steps:

- **Open All Doors:** Ensure all doors within the cleaning area are open. This allows the robot to access and map each room seamlessly.
- **Block Off Restricted Areas:** If there are specific zones you don't want the robot to enter, use physical barriers to block these areas. This can enhance mapping accuracy and prevent the robot from entering unwanted spaces. After the mapping is completed, you can remove physical barriers, and set up restricted areas to prevent the robot from entering those areas.
- **Remove Obstacles:** Clear any objects, such as toys, cables, small furniture, or fringed carpets, that might obstruct path or become entangled in its brushes. This helps RoboVac move freely and map the area without interruptions.
- **Do Not Move the Base Station:** Once the floor plan is created, avoid relocating the base station. RoboVac relies

on the base station as a reference point for navigation and mapping. Moving it may disrupt the accuracy of the floor plan.

To start the mapping process, tap **"Start"** in the app.

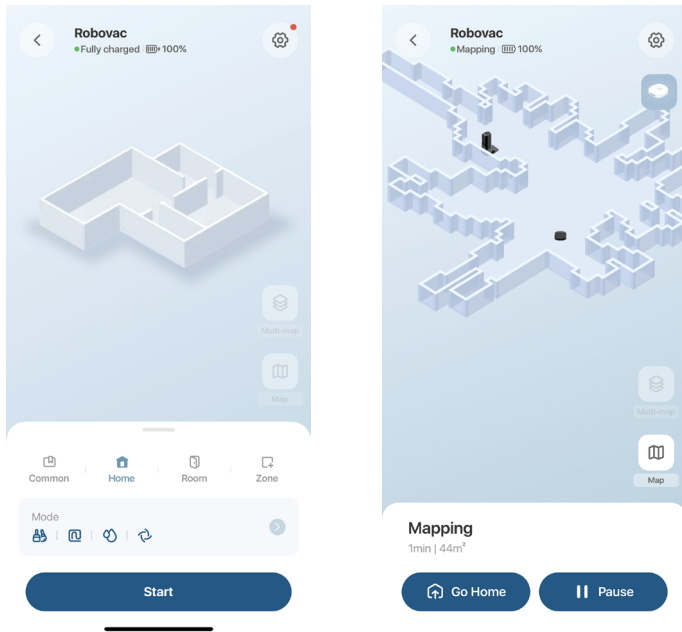

3.3 Set Up No-Go Zone and No-Mop Zone

With the eufy app, you can set up a "No-Go Zone" or "No-Mop Zone" as a restricted area. This eliminates the need to use physical barriers, including boundary strips. This feature is only designed for dividing the cleaning zones, not for isolating hazardous areas.



3.4 Schedule Cleaning

With the eufy app, you can schedule RoboVac to start cleaning at a particular time.

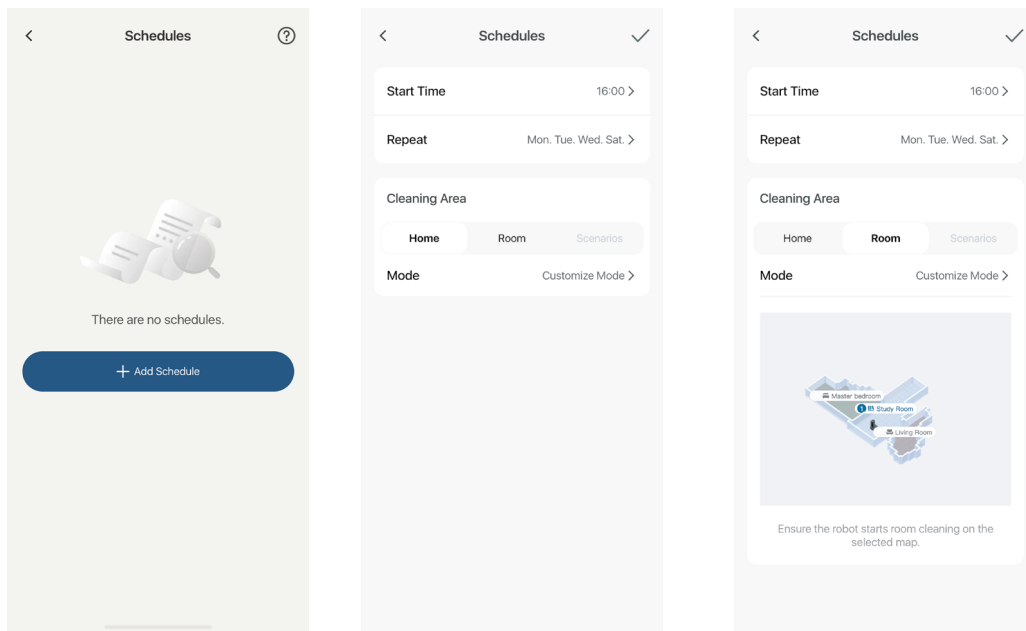

- You can set the time and customize cleaning schedules from Sunday to Saturday on the eufy app. This function is only available on the app.
- During the Do Not Disturb period, RoboVac will remain silent, with automatic dust collection and voice notifications disabled.

3.5 Select a Cleaning Mode

You can start / pause cleaning or select the desired cleaning mode via the eufy app.

In each cleaning mode, you can further customize the modes, cleaning intensity, water level, suction levels, and other settings.

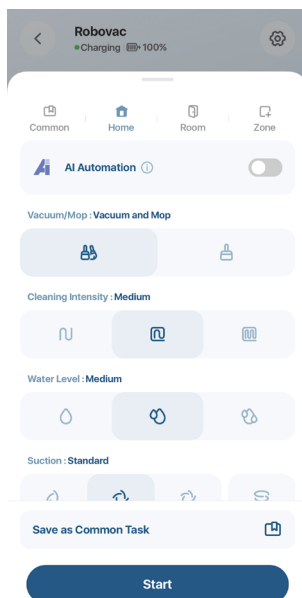

3.5.1 House Cleaning Mode

Tap "Start" in the eufy app to enable House Cleaning mode.

After startup, RoboVac moves from the Omni Station and automatically determines its cleaning route. When cleaning is finished, RoboVac automatically returns to the Omni Station.

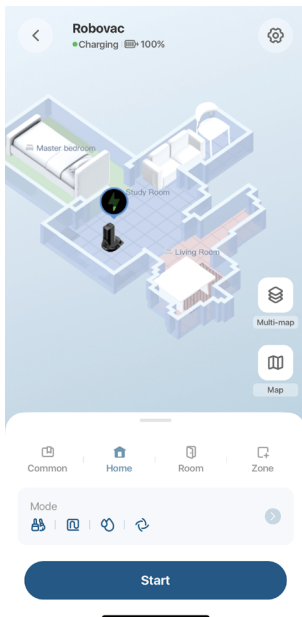

3.5.2 Room Cleaning Mode

In this mode, your house is automatically divided into several rooms for cleaning in the eufy app. You can also customize your room settings in the app. RoboVac will clean the selected rooms only and return to the Omni Station after cleaning.

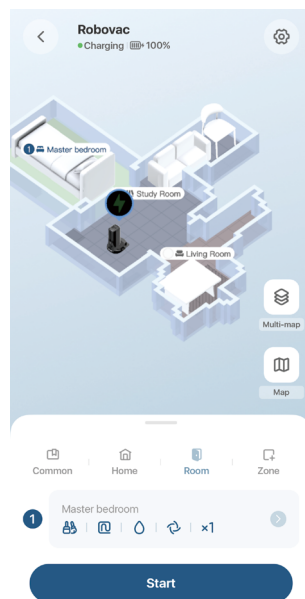
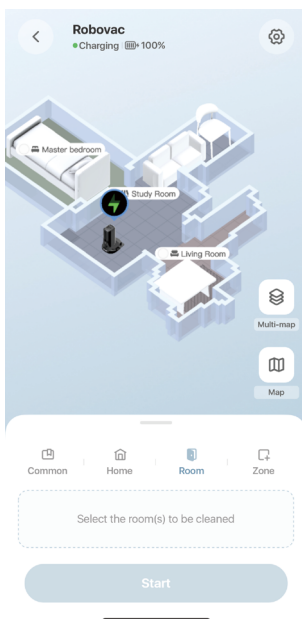

- Enable Room Cleaning mode only after RoboVac has created the map.
- It is recommended that RoboVac moves from the Omni Station to start room cleaning.

3.5.3 Zone Cleaning Mode

In this mode, you can set up a cleaning zone and customize its size in the eufy app, RoboVac will clean the selected zone only.

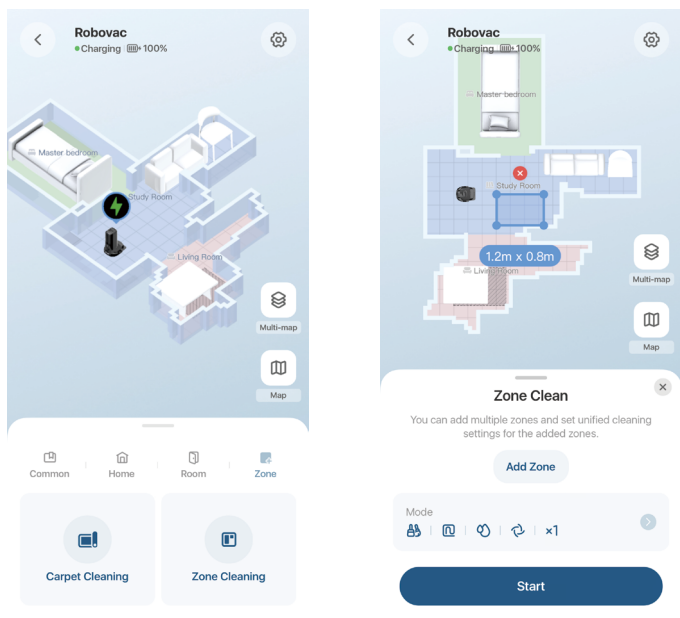

4. Using the Mopping System

1. Start cleaning. RoboVac will automatically vacuum and mop. During mopping, you can choose between three water levels via the app.
2. To prevent the development of odors in the rolling mop, be sure to activate the drying function after each mopping task. We strongly recommend setting the drying mode to "Standard Drying" to ensure optimal drying results and reduce unpleasant smells.
3. Regularly empty and clean the dirty water tank to prevent mildew or unpleasant smells. Follow the diagram below to open and close the dirty water tank. You will hear a "click" when the cover is securely closed.



 For more instructions on how to clean the dirty water tank, refer to the "Cleaning and Maintenance" section in this User Guide.

5. Using RoboVac with Matter, Alexa, Siri, or Google Assistant Compatible Devices

With Matter, Alexa, Siri, and Google Assistant compatibility, your RoboVac is just a voice command away from cleaning every corner of your house.

Before you start, make sure:

- RoboVac is attached to the Omni Station to ensure there is enough power.
- RoboVac is connected with the eufy app.
- To control your RoboVac with Siri, make sure you have an iPhone or iPad running a recent version of iOS.

To control RoboVac with Matter, Alexa, Siri, or Google Assistant:

1. Click on the top left corner of the app's main interface, then find "Third Party Services" in the dropdown menu.
2. Follow the on-screen instructions to complete the setup.

6. Enabling / Disabling Child Safety Lock

Activate the child safety lock in the eufy app: **More Settings > Child Lock**

Once the child safety lock is enabled, all buttons will be locked to prevent children from damaging the device or accidentally getting hurt.

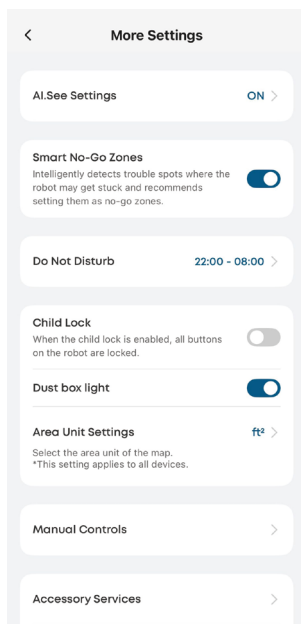

7. Cleaning and Maintenance

Before cleaning and maintaining, power off the device and unplug the power adapter. Any other servicing should be performed by an authorized service representative.

For optimal performance, follow the instructions below to clean and maintain Omni S2 regularly. The cleaning and replacement frequency will depend on your usage habits.

For step-by-step instructions, check out our accessory maintenance video at:

Recommended Cleaning and Replacement Frequency

Module	Components	Cleaning Frequency	Replacement Frequency
Robot	Dirty Water Reservoir	Every 30 hours	-
	Dust Bin	Every 60 hours	-
	Rolling Mop	-	Every 180 hours
	Rolling Brush	Every 60 hours	Every 360 hours
	High-Performance Filter	Every 180 hours	Every 360 hours
	Side Brush	Every 60 hours	Every 180 hours
	Fragrance Refill	-	Every 60 hours
	Sensors	Every 360 hours	-
	Dirty Water Reservoir Filter	-	Every 360 hours
	Swivel Wheel	Clean it based on actual conditions	-
Omni Station	Floor Cleaner	-	Every 90 hours
	Dust Bag	-	Replace as needed
	Bottom	Every month	-
	Filter Tray	Every 30 hours	-
	Clean Water Tank	Clean it based on actual conditions	-
	Dirty Water Tank	Clean it based on actual conditions	-

7.1 Clean the Dust Bin

- 1 Remove the top cover and take out the dust bin.
- 2 Rotate to open the dust bin.
- 3 Empty the dust bin.
- 4 Separate the metal and high-performance parts of the filter, and rinse them together with the dustbin. Air-dry completely before next use.
- 5 Reinstall the filter.
- 6 Place the dust bin and the top cover back into the machine.

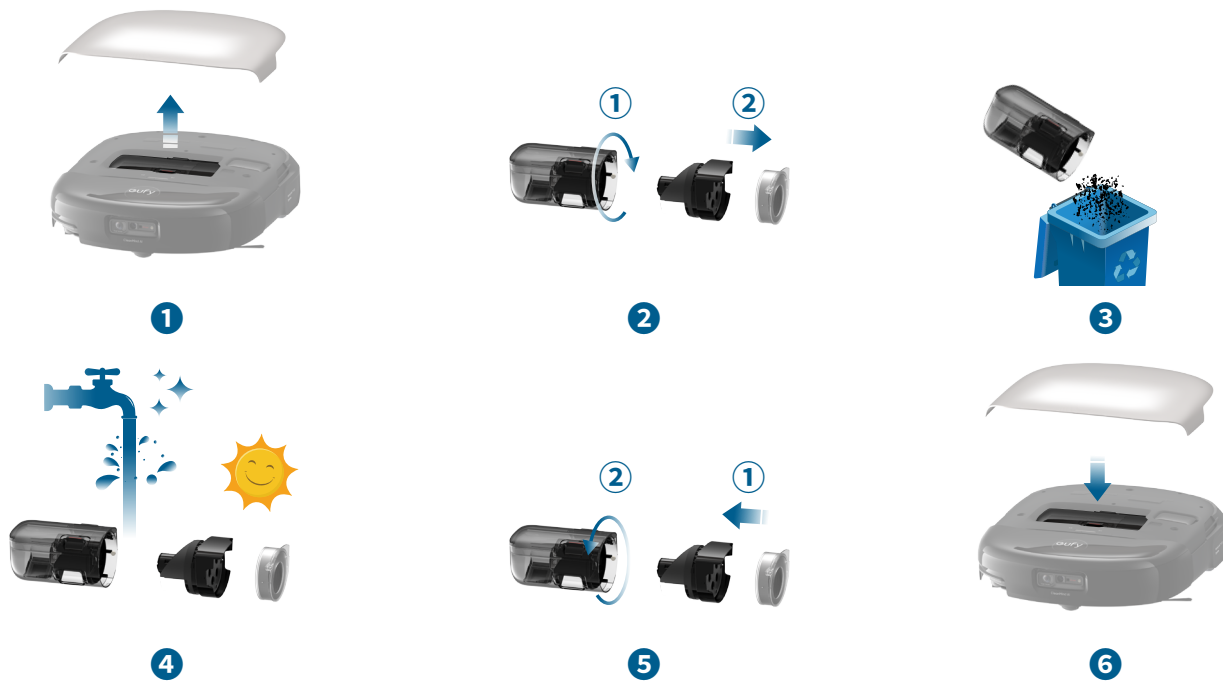

- Do not use the filter if it is not completely dry, otherwise it may affect the cleaning performance.
- Do not use a brush, hot water, or any detergent to clean the filter.

7.2 Replace the Rolling Mop

- 1 Remove the top cover and take out the dirty water reservoir.
- 2 Flip the robot over, then push the red button at the side of the rolling mop to release it.
- 3 Remove the rolling mop, and clean the debris from the roller chamber and the scraper.
- 4 Press down the replacement rolling mop until you hear a "click".



7.3 Clean the Rolling Brush

- 1 Push the release tabs to unlock the brush guard.
- 2 Push the side of one rolling brush inward and gently flip it up.
- 3 Gently twist and pull out the rolling brush.
- 4 Push the side of the other rolling brush inward and gently flip it up.
- 5 Gently twist and pull out the other rolling brush.
- 6 Rinse both rolling brushes and brush guard with running water. Air dry the rolling brushes and brush guard completely before next use.
- 7 Reinstall one side of the rolling brush and snap it into place.
- 8 Reinstall the other side of the rolling brush and snap it into place.
- 9 Press down to snap the brush guard into place.

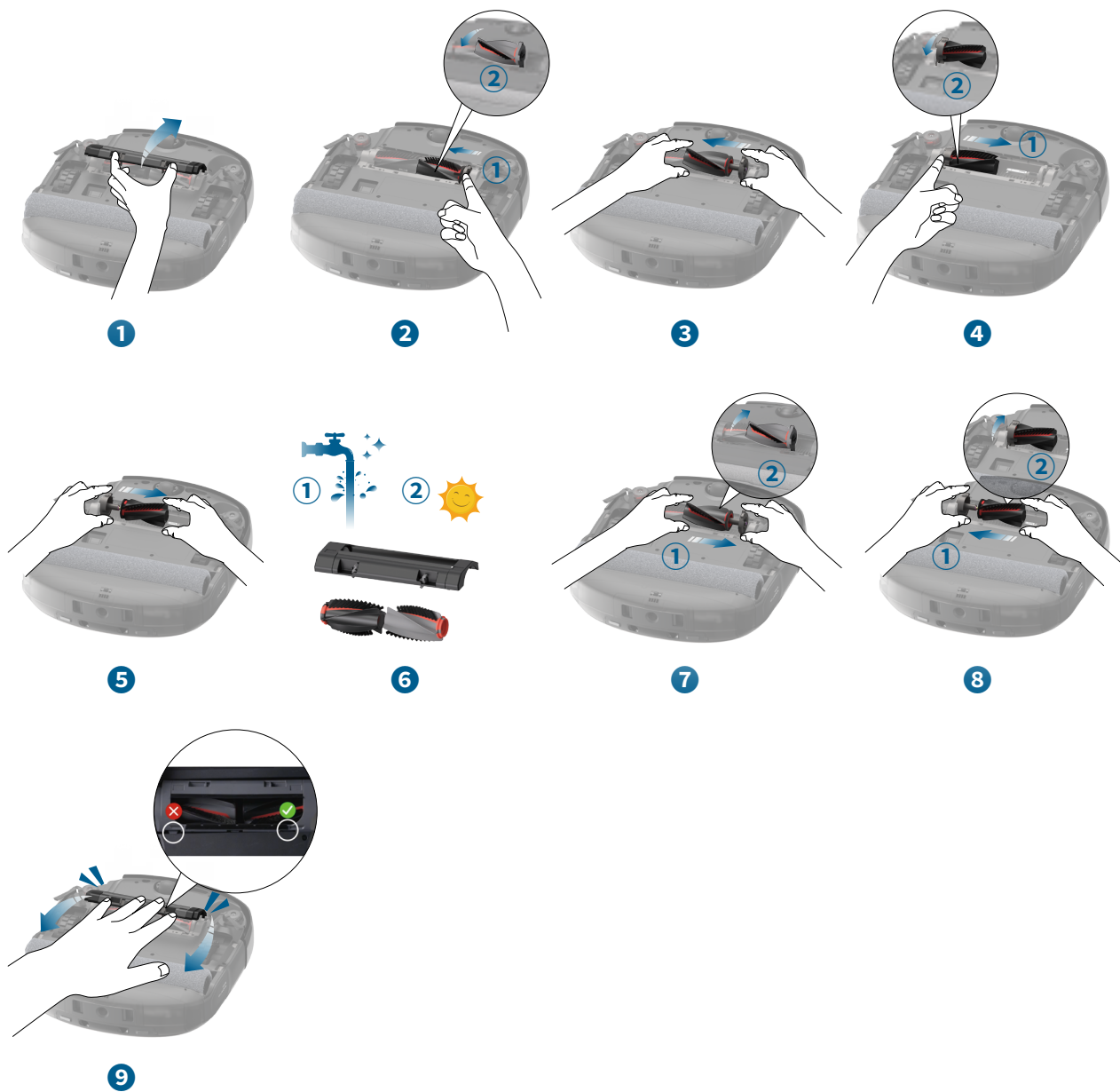

7.4 Clean the Sensors, Cameras, and Charging Contact Pins

To maintain the best performance, clean the sensors and charging contact pins regularly.

- 💡 • Before turning the robot over, remove the dirty water reservoir first.



- Dust off the sensors and charging contact pins using a soft cloth.



7.5 Replace the Dust Bag

- 1 Remove the clean water tank.
- 2 Open the cover of the dust bag container.
- 3 Install a new dust bag. Ensure the dust bag is fully inserted, then close the cover.



7.6 Clean the Filter Tray

- 1 Remove the filter tray from the Omni Station.
- 2 Rinse the filter tray thoroughly with water, and clean it with a brush.
- 3 Air dry the filter tray before next use.
- 4 Gently tilt the filter tray inward and align it with the two clips inside, and press down firmly on both sides until it clicks into place.

*The LED indicator on the Omni Station will turn from red to white when it is successfully installed.



7.7 Clean the Dirty Water Tank

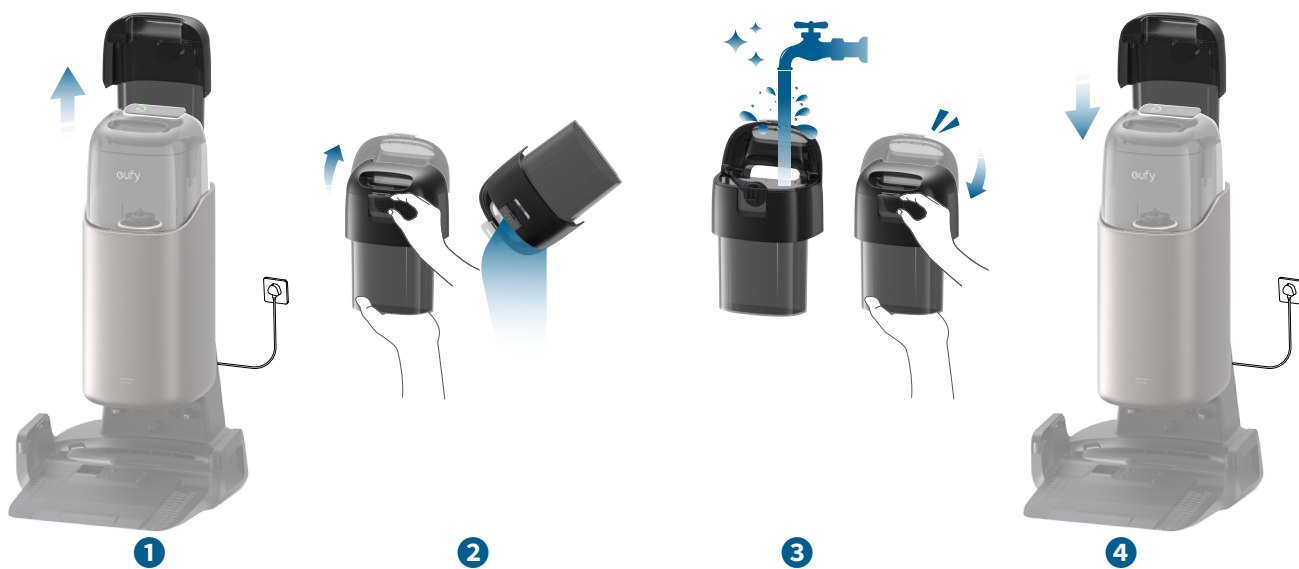

- 1 Remove the dirty water tank from the Omni Station.
- 2 Open and empty the dirty water tank.
- 3 Rinse the dirty water tank thoroughly with running water. Then, close the dirty water tank cover. You will hear a "click" when it is securely in place.
- 4 Reinstall the dirty water tank on the Omni Station.



8. Troubleshooting

When an error occurs, please refer to the in-app instructions for solutions. If the problem persists, please contact support@eufy.com for help.

9. Specifications

	Dimensions	326*358*98 mm
	Weight	11.46 lbs
	Battery	Li-ion 4600mAh DC21.6V
	Input	25V=1.5A
	Cleaning Time	Vacuum Only Mode Quiet Suction: 260 min Standard Suction: 179 min MAX Suction: 130 min
	Charging Time	4h
	Clean Water Reservoir	120ml
	Dirty Water Reservoir	150ml
Operation Frequency	2.4G Band (2.4000GHz - 2.4835GHz)	
	Dimensions	387*476*670 mm
	Weight	20.83 lbs
	Voltage	US/JP/TW Version: 100-130V EU/UK/AU Version: 200-240V
	Power (Dry and Charge)	200W MAX
	Power (Dust Collection)	650W
	Clean Water Tank	3L
	Dirty Water Tank	2L
	Disposable Dust Bag Capacity	2.5L

-  The S2 Omni Station features a warm air drying function. When the ambient temperature is above 35 °C, the Robovac will charge first; room-temperature air drying will be used until the Robovac is fully charged.
- As voltages vary across different countries and regions, we recommend purchasing the machine version specific to your location to avoid potential safety hazards and equipment damage.
- Anker Innovations Limited declares that the radio equipment type T2081 is in compliance with Directive 2014/53/EU. The full text of the EU declaration of conformity is available at the following website: <https://support.eufy.com/s/articleRecommend?type=Download>

10. Customer Service

Contact Us:



support@eufy.com



www.eufy.com



(US/CA) +1 (800)994 3056

(UK) +44 (0) 1604 936 200

(DE) +49 (0) 69 9579 7960

(JP) +81 03 4455 7823

For video tutorials, FAQs, warranty policies, and more information, please visit <https://support.eufy.com/>

Hereby, Anker Innovations Limited declares that this device is in compliance with The Product Security and Telecommunications Infrastructure (Security Requirements for Relevant Connectable Products) Regulations 2023. For the Statement of Compliance, visit the website: <https://www.eufy.com/uk/psti-related>.

Network Configuration Instructions

Network Configuration Process:

By default, the device is configured via BLE (Bluetooth Low Energy) through the mobile app. If BLE configuration fails, a button to try another configuration method (AP mode) will appear.

1. BLE (Bluetooth Low Energy) Configuration:

Trigger Condition:

Activate Bluetooth network configuration by pressing the device's reset button.

Status Description:

When the device is not yet connected to a network, it will automatically enable BLE broadcasting and activate BLE services to provide Bluetooth-based network configuration.

2. AP (Access Point) Configuration:

Trigger Condition:

Activate AP network configuration by pressing the device's reset button.

Status Description:

When the device is not yet connected to a network, it will broadcast an open (no password) and visible AP hotspot to provide network configuration via AP mode.

The device will:

- Listen for network configuration requests on TCP port 6668.

Note:

During the BLE and AP configuration processes, please ensure your network environment is stable and follow the instructions to complete the setup. If you encounter any issues, you can press the reset button again to restart the configuration process.