

EN BORA Classic 2.0 system operating instructions

Cooktop extractor and cooktops

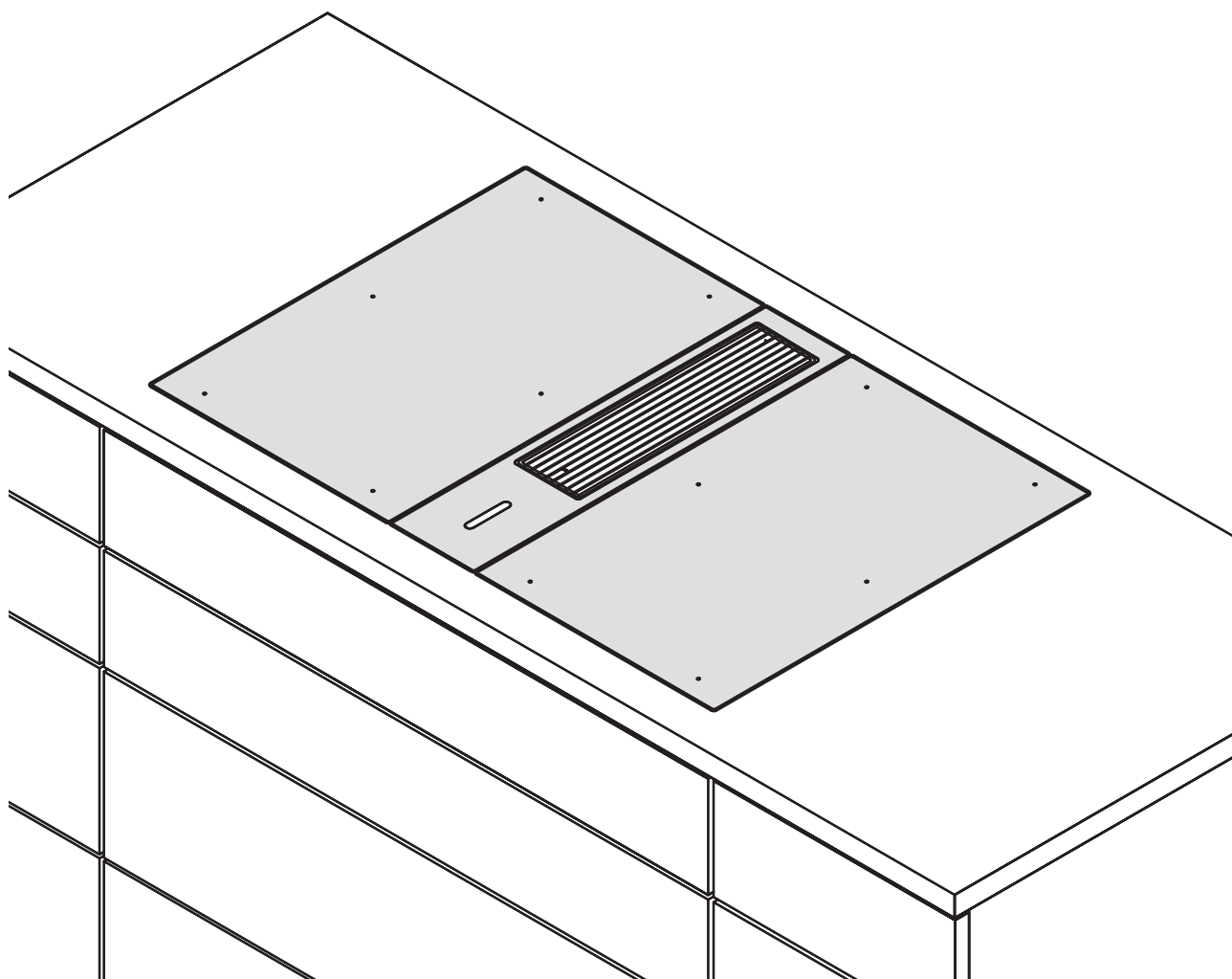

C2XUMEN-004

www.bora.com

Operating instructions:

Original

Translation

Manufacturer

BORA Vertriebs GmbH & Co KG

Innstraße 1
6342 Niederndorf
Austria

Contact

T +43 (0) 5373/62250-0
mail@bora.com
www.bora.com

The distribution and duplication of this document, as well as the use and disclosure of its contents are prohibited unless expressly authorised.

Great care was taken when devising these operating and installation instructions. However, it may be the case that later technical changes or adaptations to the system software have not yet been added or the corresponding contents have not yet been modified. We apologise for this. A up-to-date version can be requested from the BORA Service team. Misprints and errors excepted.

© BORA Vertriebs GmbH & Co KG

All rights reserved.

Table of Contents

1	General information	5	6	Operation	31
1.1	Target group.....	5	6.1	General and specific operating instructions.....	31
1.2	Validity.....	5	6.1.1	Special operating instructions for the Tepan stainless steel grill CKT.....	31
1.3	Other applicable documents.....	5	6.1.2	Special operating instructions for gas glass ceramic cooktop CKG.....	31
1.4	Data protection.....	5	6.2	Touch control.....	33
1.5	Presentation of information.....	5	6.3	Operating the system.....	33
2	Safety	7	6.3.1	Operating principle.....	33
2.1	General safety instructions.....	7	6.3.2	Switching on.....	33
2.2	Safety instructions – cooktop operation.....	8	6.3.3	Switching off.....	33
2.3	Safety instructions – cooktop extractor operation.....	10	6.3.4	Control lock.....	34
2.4	Safety instructions – cleaning and maintenance..	11	6.3.5	Cleaning lock (wipe function).....	34
2.5	Safety instructions – spare parts.....	11	6.3.6	Childproofing feature.....	34
2.6	Use as intended.....	12	6.3.7	Short-time timer (egg timer).....	34
3	Energy labelling	13	6.4	Operating the cooktop extractor.....	34
4	Appliance description	14	6.4.1	Setting the fan power level.....	34
4.1	BORA Classic 2.0 system.....	14	6.4.2	Fan power setting.....	35
4.1.1	Operating panel and operating principle.....	14	6.4.3	Automatic extractor function.....	35
4.1.2	Symbols.....	15	6.4.4	Switching the fan off.....	35
4.1.3	7-segment display.....	16	6.4.5	Switching off the automatic after-run early.....	35
4.1.4	Colour concept.....	16	6.5	Operating the cooktops.....	35
4.1.5	Lighting.....	16	6.5.1	Selecting cooking zones.....	35
4.1.6	Sounds.....	17	6.5.2	Setting cooking zone power levels.....	36
4.1.7	System functions.....	17	6.5.3	Switching off the cooking zone.....	37
4.2	Cooktop extractor.....	17	6.5.4	Automatic heat up function.....	37
4.2.1	Model description.....	17	6.5.5	Power setting.....	37
4.2.2	Installation variations.....	17	6.5.6	Two-ring connection on cooktops CKCH and CKCB.....	37
4.2.3	Overview of features and functions.....	18	6.5.7	Bridging function.....	38
4.2.4	Structure.....	18	6.5.8	Setting the warming level.....	38
4.2.5	Cooktop extractor functions.....	18	6.5.9	Cleaning function on the Tepan stainless steel grill CKT.....	39
4.2.6	USB interface.....	19	6.5.10	Cooking zone timer.....	39
4.2.7	Interface for external devices.....	19	6.5.11	Pause function.....	40
4.3	Cooktops.....	19	7	Menu	41
4.3.1	Model description.....	19	7.1	Menu overview.....	41
4.3.2	Overview of features and functions.....	19	7.2	How to use the menu.....	41
4.3.3	Structure.....	20	7.3	Standard menu items.....	42
4.3.4	How the Induction cooktops work (CKFI, CKI, CKIW).....	23	7.3.1	Menu item 1: Volume of the acoustic signals... ..	42
4.3.5	How the Hyper and HiLight cooktops work (CKCH, CKCB).....	24	7.3.2	Menu item 2: Childproofing feature.....	42
4.3.6	How gas glass ceramic cooktop CKG works.....	25	7.3.3	Menu item 3: Automatic extractor control.....	43
4.3.7	How the Tepan stainless steel grill CKT works..	26	7.3.4	Menu item 4: Duration of the cleaning lock (wipe function).....	43
4.3.8	Cooktop functions.....	26	7.3.5	Menu item 5: Duration of the automatic after-run function.....	43
4.4	Safety devices.....	27	7.3.6	Menu item 6: Retrieving the software version... ..	44
4.4.1	Control lock.....	27	7.3.7	Menu item 7: Retrieving the hardware version..	44
4.4.2	Cleaning lock (wipe function).....	27	7.3.8	Menu item 8: System software update.....	44
4.4.3	Safety shut-down.....	27	7.3.9	Menu item 9: Data export.....	45
4.4.4	Residual heat indicator.....	28	7.3.10	Menu item A: Show the recirculation filter service life (only in recirculation mode).....	45
4.4.5	Overheating protection.....	28	7.3.11	Menu item B: Show filter type, change filter type and reset filter service life (only in recirculation mode).....	46
4.4.6	Childproofing feature.....	28	8	Extended menu	47
5	Initial operation	29	8.1	Calling up the extended menu.....	47
5.1	Basic configuration.....	29	8.2	Extended menu items.....	48
5.1.1	Carrying out the basic configuration.....	29	8.2.1	Menu item B: Show filter type, change filter type and reset filter service life (only in recirculation mode).....	48
5.1.2	Menu item H: Extraction system configuration... ..	29	8.2.2	Menu item D: Demo mode.....	48
5.1.3	Menu item J: Select the filter type (only in the case of recirculation).....	30			
5.1.4	Menu item L: Fan configuration.....	30			
5.1.5	Completing basic configuration.....	30			

8.2.3	Menu item E: Display and button test	49
8.2.4	Menu point F: Reset to factory settings	49
8.3	Gas configuration menu	49
8.3.1	Menu item P: GPU	50
8.3.2	Menu item S: GAS	50
8.3.3	Menu item T: GAS	51
9	Cleaning and Maintenance	52
9.1	Cleaning agents	52
9.2	Looking after your appliances	52
9.3	Cleaning cooktop extractor CKA2	52
9.3.1	Removing the components	52
9.3.2	Cleaning the components	53
9.3.3	Fitting the components	53
9.3.4	Replacing the recirculated air filter	53
9.4	Cleaning the cooktops	54
9.4.1	Cleaning glass ceramic (CKFI, CKI, CKIW, CKCH, CKGB, CKG)	54
9.4.2	Cleaning Tepan stainless steel grill surfaces (CKT)	54
9.4.3	Cleaning the components on gas cooktop CKG	55
10	Troubleshooting	57
11	Warranty, technical service, spare parts, accessories	60
11.1	BORA manufacturer's warranty	60
11.1.1	Warranty extension	60
11.2	Service	60
11.3	Spare parts	60
11.4	Accessories	61
12	Notes	62
13	Identification plates	63

1 General information

1.1 Target group

These operating instructions apply to the following target groups:

Target group Requirements

Users	The appliance can be used by children aged 8 and over as well as people with reduced physical, sensory or mental capacities or a lack of experience and/or knowledge if they are supervised or have been instructed how to safely use the appliance and understand the resultant risks. Children must be supervised. All safety and warning information, as well as the instructions in the operating manual must be observed.
-------	--

Tab. 1.1 Target groups

INFO BORA Holding GmbH, BORA Vertriebs GmbH & Co KG, BORA APAC Pty Ltd and BORA Lüftungstechnik GmbH – hereinafter referred to as BORA – does not assume any liability for damage arising from disregard for or non-adherence to these documents and improper installation! The electricity and gas supply must be connected by a certified specialist. Installation may only be carried out in accordance with the applicable standards, regulations and laws. All safety and warning information, as well as the handling instructions in the operating and installation instructions must be observed.

1.2 Validity

INFO These instructions describe the BORA Classic 2.0 system with software version 03.00.

These instructions apply to several appliance versions. It is therefore possible that some of the features described do not apply to your appliance. The details of the figures contained herein may differ from some appliance versions and are to be understood as schematic diagrams.

1.3 Other applicable documents

Other documents apply to these instructions and must be taken into account, particularly the BORA Classic 2.0 system installation instructions.

Please by all means adhere to all documents that form part of the scope of delivery.

INFO BORA does not assume any liability for damage arising from non-adherence to these documents.

Directives

The appliances meet the following EU/EC directives:

2014/30/EU EMC Directive
2014/35/EU Low Voltage Directive
2009/125/EC Ecodesign Directive
2011/65/EU RoHS Directive

Regulations

Gas appliances meet the following EU directives:
(EU) 2016/426 regulation on appliances burning gaseous fuels

1.4 Data protection

During operation your cooktop extractor saves pseudonymised data such as menu settings entered by you, operating hours of the individual technical units and the number of functions selected. Furthermore, your cooktop extractor documents errors in combination with the number of operating hours.

The data can only be read manually via your cooktop extractor, thus the decision is yours.

The saved data then enable a rapid error search and troubleshooting in case of service.

1.5 Presentation of information

We use standard formatting, numbering, symbols, safety instructions, terms and abbreviations so that you can work quickly and safely when using this manual.

Instructions are indicated with an arrow.

► Always follow all instructions in the prescribed order.

Enumerations are indicated with a square bullet point at the start of the line.

■ Enumeration 1

■ Enumeration 2

INFO Information notes point to special features that must be taken into account.

Safety and warning instructions

The safety and warning instructions in this manual are emphasised with symbols and signal words.

Safety and warning instructions are structured as follows:

WARNING SYMBOL AND SIGNAL WORD!



Type and source of danger

Results of non-compliance

► Measures to minimise risk

Please note:

- The warning symbol draws your attention to the risk.
- The signal word indicates the severity of that risk.

Warning symbol	Signal word	Risk
	Danger	Indicates an immediate, hazardous situation which causes death or serious injury if not respected.
	Warning	Indicates a potentially hazardous situation which can cause death or serious injury if not respected.
	Caution	Indicates a potentially hazardous situation which can cause minor injury if not respected.
—	Caution	Indicates a situation which can cause property damage if not respected.

Tab. 1.2 Meaning of the warning symbols and signal words

2 Safety

2.1 General safety instructions

INFO The appliance complies with the stipulated safety requirements. The user is responsible for appliance cleaning and maintenance as well as its safe use. Improper use can lead to personal injury and damage to property.

- The operating and installation instructions contain important information about installation and operation. These enable you to protect yourself against injuries and prevent damage to the appliance. Contact details for further information as well as application and usage questions can be found on the back.
- The term “appliance” is used to refer to cooktops, cooktop extractors or cooktops with integrated cooktop extractor.
 - ▶ Read the operating and installation instructions fully before using the appliance for the first time.
 - ▶ Always store the operating and installation instructions within easy reach so that they can be accessed if required.
 - ▶ Pass the operating and installation instructions to the next owner if you sell the appliance.
 - ▶ Conduct all work extremely attentively and conscientiously.
 - ▶ Check the appliance for visible damage when unpacking it.
 - ▶ Do not connect a damaged appliance.
 - ▶ Do not connect the appliance to the mains until the duct system has been installed or the recirculation filter has been fitted.
 - ▶ Only use the connection cables supplied in the scope of delivery.
 - ▶ Do not use the appliance until installation is complete. This is the only way to ensure safe operation.
 - ▶ Make sure contact with hot cooking surfaces is not possible.
 - ▶ Do not place any objects on the operating panel or the cooktop extractor air inlet nozzle.
 - ▶ Switch off the appliance after use.
 - ▶ Keep pets away from the appliance.

CAUTION!

Appliance components can cause injury if dropped!

Appliance components such as pan supports, operating controls, covers, grease filters, etc. can cause injury if dropped.

- ▶ Place any appliance components that have been removed in a safe place near the appliances.
- ▶ Ensure that no components removed from the appliance can fall on the floor.

Unauthorised modifications

Unauthorised modifications can cause the appliance to pose risks.

- ▶ Do not make any changes to the appliance.

Households with children and people with special needs

- ▶ The appliance can be used by children aged 8 and over as well as people with reduced physical, sensory or mental capacities or a lack of experience and/or knowledge if they are supervised or have been instructed how to use the appliance safely and understand the resultant risks.
- ▶ Supervise children in the vicinity of the appliance.
- ▶ Children must not play with the appliance.
- Use the childproofing feature in order to prevent children from switching on the appliances or changing the settings when they are unattended.
- ▶ Do not store any items that could be of interest to children in storage spaces above or behind the appliance. Otherwise, they will be tempted to climb onto the appliance.
- ▶ Keep children and other persons away from hot cooking surfaces.

Recirculation mode

INFO When cooking, additional moisture is released into the ambient air.

INFO In recirculation mode, only a slight amount of moisture is removed from the cooking vapour.

- ▶ When using recirculation mode, ensure a sufficient supply of fresh air, e.g. by opening a window.
- ▶ Ensure a normal and comfortable room climate (humidity of 45–60%), e.g. by opening natural ventilation openings or using domestic ventilation systems.
- ▶ After every use in recirculation mode, switch the cooktop extractor to a low level for about 20 minutes or activate the automatic after-run function.

2.2 Safety instructions – cooktop operation

- ▶ Avoid over-cooking.
- ▶ Pay attention to the residual heat indicator.
- ▶ Make sure that the base of the cookware as well as the cooking zones are clean and dry.
- ▶ Always lift (do not drag!) the cookware to prevent scratching and abrasion on the surface.
- ▶ Do not place any hot cookware on the air inlet nozzle or operating unit of the cooktop extractor.



DANGER!

Danger of fire caused by leaving the cooktop unattended!

Oil or fat in the pot can quickly heat up and ignite.

- ▶ Never leave oil or fat to heat up unattended.
- ▶ Never extinguish oil and fat fires with water.
- ▶ Switch off the cooktop.
- ▶ Suffocate the fire, for example by using a lid.



DANGER!

Risk of explosion caused by flammable liquids!

Flammable liquids in the vicinity of a cooktop can explode and cause serious injury.

- ▶ Do not place any flammable liquids in the vicinity of a cooktop.



DANGER!

Risk of electric shock!

Cracks, fissures or fractures in the glass ceramic panel can damage the underlying electronics. This can cause an electrical shock.

- ▶ If there are any cracks, fissures or fractures in the glass ceramic, switch the appliance off immediately.
- ▶ Securely disconnect the appliance from the mains using the LS switch, fuses, automatic circuit breakers or contactor.



WARNING!

Risk of burns from hot cooktop!

The cooktop and its exposed areas get hot during use. Once the cooking zone is switched off, it takes a little while to cool down to below 60 °C. Touching hot surfaces can cause serious burns.

- ▶ Never touch the cooktop when it is hot.
- ▶ Keep children away from the cooktop when it is hot or ensure they are supervised at all times.



WARNING!

During or after a power cut, cooktops may still be hot!

In the event of a power cut, a cooktop that was previously in operation may still be hot even though there is no indication of residual heat.

- ▶ Do not touch the cooktop while it is still hot.
- ▶ Keep children away from the hot cooktop.



WARNING!

Risk of fire from objects on the cooking surfaces!

The cooktop and its exposed parts are hot when the cooking zone is switched on and during the cooling phase. Objects on the cooktop can heat up and catch fire.

- ▶ Do not place any items on the cooktop.

**WARNING!****Risk of burns from hot objects!**

The cooktop and its exposed parts are hot when the cooktop is in use and during the cooling phase. Objects on the cooktop heat up very quickly and can cause serious burns. This particularly applies to metal objects (e.g. knives, forks, spoons, lids or cooktop extractor covers).

- ▶ Do not place any items on the cooktop.
- ▶ Please use suitable tools (pot holders, oven gloves).

**WARNING!****Risk of burns from hot cookware!**

Handles projecting over the edge are enticing for children to grab.

- ▶ Do not turn pot and pan handles so they stick out beyond the work surface.
- ▶ Make sure that children cannot pull hot pots and pans over.
- ▶ Use suitable stove guards.
- ▶ Do not use unsuitable stove guards (accident risk).
- ▶ To choose a suitable stove guard, contact your specialist supplier or the BORA Service Team.

**WARNING!****Risk of burns!**

Liquid between the cooking zone and the pan base can evaporate and cause burns.

- ▶ Make sure that the cooking zone and the pan base are always dry.

CAUTION!**Damage from hard and pointed objects!**

Hard and pointed objects can damage the glass ceramic panel of the cooktop.

- ▶ Do not use the surface of the cooktop as a worktop.
- ▶ Do not use hard and pointed objects when working on the cooktop.

CAUTION!**Damage from sugary and salty foods!**

Sugary and salty foods and juices can damage the hot cooking zone.

- ▶ Make sure sugary and salty foods or juices do not get onto the cooking zone while it is hot.
- ▶ Remove sugary and salty foods and juices from the hot cooking zone immediately.

CAUTION!**Escaping hot liquids!**

Unattended pans can boil over allowing hot liquids to escape.

- ▶ Always keep an eye on pans while cooking.
- ▶ Short cooking sessions must be constantly monitored.

CAUTION!**Damage caused by objects on the cooktop!**

Objects such as cookware lids on the cooktop can damage the glass ceramic panel.

- ▶ Do not place any objects on the cooktop while it is hot.

2.2.1 Special safety information for induction cooktops

- ▶ Do not rely on the pan size recognition.

Effect on pace makers, hearing aids and metal implants

INFO

Induction cooktops generate a high-frequency electromagnetic field in the area of the cooking zones. The cooking zones may affect pacemakers, hearing aids or metal implants negatively or disturb their function when in close proximity. A reduced function of the pacemaker is unlikely.

- ▶ If in doubt, contact the manufacturer of your medical device or your doctor.

2.2.2 Special safety information for gas cooktops

- ▶ Do not use the appliance to heat the room.
- ▶ Do not use or store any flammable materials near the appliance.



DANGER!

Risk of explosion from gas!

Gas leaks can cause explosions and serious injuries.

- ▶ Keep ignition sources (naked flames, heaters) away.
- ▶ Close the gas supply and turn off the mains supply.



DANGER!

Risk of asphyxiation as a result of a gas leak!

Gas leaks can cause asphyxiation.

- ▶ If you smell gas while using the appliance, switch it off immediately.
- ▶ Close the gas supply immediately.
- ▶ Ensure there is a good supply of fresh air (open doors and windows).
- ▶ Do not use any light switches or device switches.
- ▶ Do not remove plugs from sockets (risk of sparking).
- ▶ Do not use electrical devices.
- ▶ Inform customer services or your gas installer immediately.



DANGER!

Fire risk from naked flame!

A naked flame can cause adjacent objects to catch fire.

- ▶ Turn the gas flame down to the lowest level if you remove pots or pans briefly from the hob.
- ▶ Never leave a naked flame unattended.
- ▶ Extinguish any fire using a lid or a fire blanket, for example.
- ▶ Close the gas supply and turn off the mains supply.

CAUTION!

Risk of injury from cracks, fissures or fractures in the glass ceramic panel!

A damaged glass ceramic panel can cause injuries.

- ▶ Do not touch the surface of the appliance.
- ▶ Switch off all burners and electrical heating elements immediately.
- ▶ Securely disconnect the appliance from the mains using the LS switch, fuses, automatic circuit breakers or contactor.
- ▶ Do not use the appliance.



WARNING!

Risk of burns from hot cooktop extractor!

The cooktop extractor and its exposed parts (in particular the cover flap, stainless steel grease filter and grease filter tray) become hot when the gas cooktop is in use. Once the gas cooktop is switched off, it takes a little while to cool down to below 60 °C. Touching hot surfaces can cause serious burns.

- ▶ Never touch the cooktop extractor when it is hot.
- ▶ Keep children away from the cooktop extractor when it is hot or ensure they are supervised at all times.

2.3 Safety instructions – cooktop extractor operation

- ▶ Only operate the integrated cooktop extractor with BORA cooktops. This particularly applies to BORA gas cooktops.
- ▶ Do not place any hot cookware in the area of the operating panel so as not to damage the underlying electronics.



DANGER!

Risk of smoke inhalation!

Using a fireplace that depends on the air in the room produces combustion gases.

If the cooktop extractor is used in conjunction with a fireplace that depends on the air in the room, toxic combustion gases (carbon monoxide) can be extracted from the chimney or outlet duct into the living area.

- ▶ Make sure that there is always a sufficient air supply.

**DANGER!****Fire risk from flambéing!**

While the cooktop extractor is working, it sucks up grease from cooking. Flambéing food can cause the grease to catch fire.

- ▶ Clean the cooktop extractor regularly.
- ▶ Never work with a naked flame while the cooktop extractor is running.

**DANGER!****Fire risk from fat deposits!**

If the stainless steel grease filter is not cleaned regularly, this can lead to increased levels of grease in it. This increases the fire risk.

- ▶ Clean and replace the filter at regular intervals.

**WARNING!****Risk of injury due to moving fan wheel!**

There is a risk of injury while the fan is turning.

- ▶ Only install the device with the power disconnected.
- ▶ Connect both sides of the fan to the duct system before commissioning.
- ▶ Ensure that the inlet nozzle is locked before the device is commissioned for the first time.

**CAUTION!****Exposed parts may become hot!**

The cooktop extractor and its exposed parts are hot when the cooking zone is switched on and during the cooling phase.

- ▶ Do not place any items on the cooktop.
- ▶ Please use suitable tools (pot holders, oven gloves).

CAUTION!**Damage caused by objects or paper suctioned in!**

Small and light items, such as cleaning cloths made from material or paper, can be suctioned into the cooktop extractor. This can damage the fan or impair the exhaust performance.

- ▶ Do not store any items or paper on the cooktop extractor.
- ▶ Only operate the integrated cooktop extractor with the grease filter fitted.

CAUTION!**Damage caused by grease and dirt deposits!**

Grease and dirt deposits can prevent the cooktop extractor from functioning properly.

- ▶ Never use the cooktop extractor without a stainless steel grease filter.

2.4 Safety instructions – cleaning and maintenance

The appliance must be cleaned at regular intervals. Dirt can lead to damage, restriction of functions or bothersome odours. Remove dirt immediately.

- Any work involving cleaning and maintenance must not be carried out by children unless they are supervised at all times while doing so.
- ▶ Do not use a steam cleaner for cleaning. Steam can cause a short circuit on live parts and thus lead to property damage (see the Cleaning and Maintenance chapter).
- ▶ When cleaning, ensure that no water penetrates the appliance. Use only a slightly damp cloth. Never spray the appliance with water. Water penetration can cause damage!
- ▶ Whenever possible, clean the cooktops after every use.
- ▶ Clean the glass ceramic cooktops only after they have cooled down (see the Cleaning and Maintenance chapter).
- ▶ Use the cleaning function to clean the BORA Classic Tepan stainless steel grill CKT.
- ▶ When cleaning, only use non-abrasive detergents to prevent scratching and abrasion on the surface.
- ▶ Make sure that the floor unit is not soiled by the ventilation openings.

2.5 Safety instructions – spare parts

**WARNING!****Risk of injury and damage to property!**

Incorrect components can lead to personal injury or damage to the appliance. Modifications, additions or alterations to the appliance can lead to safety risks.

- ▶ Only use original spare parts for repairs.

INFO A damaged mains cable must be replaced by another suitable mains cable. This may only be done by an authorised member of the After Sales Service team.

2.6 Use as intended

The appliance cannot be used at altitudes above 2000 m (metres above sea level).

Information on gas cooktops:

At an increased altitude the power of the burners on the cooktop is reduced.

The appliance is solely intended for preparing food in private households. This appliance is not intended for:

- outdoor use
- installation in vehicles
- heating rooms
- use in non-stationary installation sites (e.g. on ships)
- use with an external timer or a separate remote control system (remote operation)

Any use other than that specified in these operating and installation instructions or any use that goes beyond that which is described here is classed as unintended. BORA does not assume any liability for damages caused by improper use or incorrect operation.

All misuse is prohibited!

INFO BORA Holding GmbH, BORA Vertriebs GmbH & Co KG, BORA APAC Pty Ltd and BORA Lüftungstechnik GmbH do not assume any liability for damage arising from non-adherence to the safety and warning information.

3 Energy labelling

Product description		BORA Classic cooktop extractor CKA2	
Operating mode	Exhaust air		
Energy consumption	Value	EN standard	
Annual energy consumption (AEC_{hood})	30.7 kWh/a	61591	
Energy efficiency class	A+	61591	
Flow volume			
Fluid dynamic efficiency (FDE_{hood})	33.7 %	61591	
Fluid dynamic efficiency class	A	61591	
Air flow level 1 minimum	225.2 m ³ /h	61591	
Air flow level 5 maximum	520.9 m ³ /h	61591	
Air flow power setting (Q_{WP})	565.5 m ³ /h	61591	
Lighting			
Lighting efficiency (LE_{hood})	* lx/Watt	*	
Lighting efficiency class	*	*	
Grease filtering			
Level 5 maximum (GFE_{hood})	96.5 %	61591	
Class at maximum level	A	61591	
Sound power level			
Level 1 minimum	41.6 dB(A)	60704-2-13	
Level 5 maximum	62.1 dB(A)	60704-2-13	
Power setting	63.8 dB(A)	60704-2-13	
Sound pressure level (additional details)			
Level 1 minimum	28.9 dB(A)	**	
Level 5 maximum	49.4 dB(A)	**	
Power setting	51.1 dB(A)	**	
Details according to 66/2014			
Power consumption in off mode (P_o)	0.3 W	61591	
Time increase factor	0.8	61591	
Energy efficiency index (EEI_{hood})	42	61591	
Air flow rate at the best efficiency point (Q_{BEP})	265.6 m ³ /h	61591	
Air flow power setting (Q_{Max})	578.6 m ³ /h	61591	
Pressure at the best efficiency point (P_{BEP})	480 Pa	61591	
Electric power input at the best efficiency point (W_{BEP})	105.0 W	61591	

Tab. 3.1 Energy labelling instructions according to Regulation (EU) 65/2014 and 66/2014 respectively

* This specification is not applicable for this product.

** The sound pressure level has been determined from a distance of 1 m (distance-dependent level recording) on the basis of the sound power level established in EN 60704-2-13.

4 Appliance description

Observe all safety and warning information during operation (see Safety chapter).

4.1 BORA Classic 2.0 system

- ▶ Always use the latest system software to operate the BORA Classic 2.0 system.

INFO The latest software is available free of charge on the BORA website (www.bora.com – Products – BORA Classic 2.0 – BORA Classic cooktop extractor CKA2 – Documents).

- ▶ If necessary, retrieve the installed software version (see Menu chapter, Retrieving the software version).
- ▶ Update the system software if necessary (see Menu chapter, Updating the system software)

4.1.1 Operating panel and operating principle

INFO The BORA Classic 2.0 system is operated via the operating panel on cooktop extractor CKA2.

INFO 1 or 2 cooktops can be controlled and operated by a single cooktop extractor.

INFO The operating principle and functions are described in more detail in the Operation chapter.

The cooktop extractor and cooktops are operated via a central operating panel. The operating panel is fitted with electronic sensor buttons and display panels. The sensor buttons respond to finger contact (touch zones).

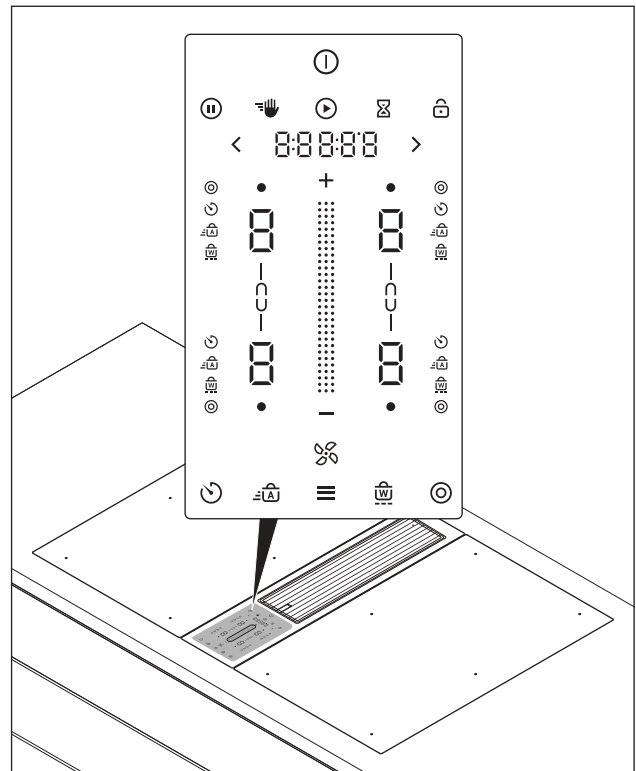

Fig. 4.1 Central touch/slider operating panel

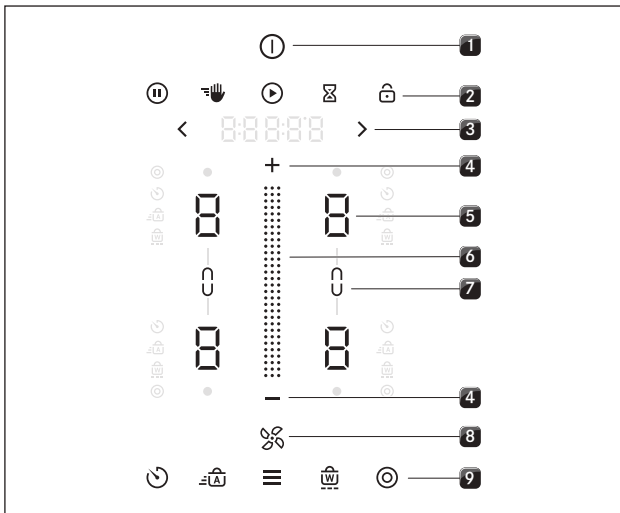

Fig. 4.2 Touch zones

- [1] Switching on/off
- [2] Higher-level functions
- [3] Navigation
- [4] Power level setting zone plus/minus
- [5] Cooking zone selection (4x)
- [6] Touch slider (power level setting zone)
- [7] Bridging function (2x)
- [8] Fan
- [9] Additional cooking functions and menu

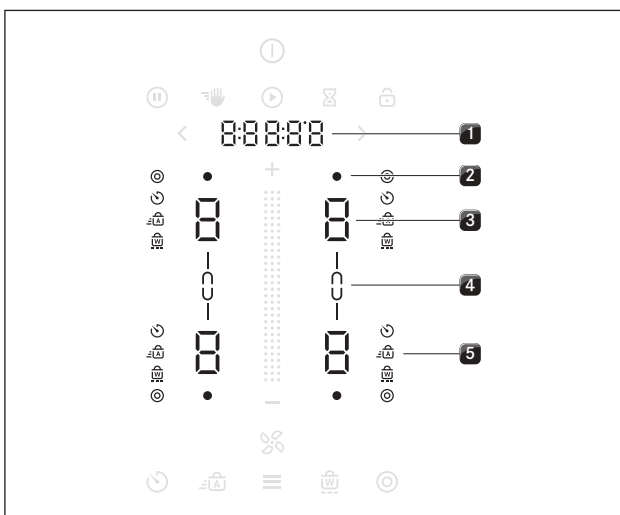

Fig. 4.3 Indicator zones

- [1] Multi-function display
- [2] Hot cooking zone or residual heat indicator (4x)
- [3] Cooking zone indicator (4x)
- [4] Bridging function indicator (2x)
- [5] Additional cooking function indicator (4x4)

4.1.2 Symbols

General symbols	Description	Function/meaning
	Power button	Switching on/off
	Pause button	Activating/deactivating the pause function
	Cleaning button	Activating/deactivating the cleaning lock
	Start button	Starting the timer
	Egg timer button	Setting the short-time timer (egg timer)
	Lock button	Control lock
	Slider	Setting values
	Plus button	Increasing values
	Minus button	Decreasing values
	Forwards button	Navigation to the right
	Backwards button	Navigation to the left
	Fan button	Activating/deactivating the automatic extractor function, cancelling the after-run function
	Menu button	Calling up the menu, closing the menu
Cooking zone symbols	Description	Function/meaning
	Ring button	2-ring additional switching
	Timer button	Setting the cooking zone timer
	Heat-up button	Activating/deactivating the automatic heat up function
	Warming button	Activating/deactivating the warming function
	Bridging button	Activating/deactivating the bridging function
	Bridging indicator	Bridging function active
	Hot indicator	The cooking zone is heating up or is still hot

Tab. 4.1 Meaning of the symbols displayed (icons)

4.1.3 7-segment display











Multi-function display		Meaning
Fan indicator	1-5	Power levels
	P	Power setting
	A	Automatic extractor function
Multi-function display	e.g. 190°	Temperature indicator (only on CKT)
	00:00:00	Remaining time on the time or egg timer
	e.g. E 123	Error code
Cooking zone indicator		Meaning
Cooking zone indicator	1-9	Power levels
	P	Power setting
	-	Warming level 1
	=	Warming level 2
	≡	Warming level 3
	0	Inactive
	H	Residual heat indicator (cooking zone is switched off but still hot)
	C	Cleaning (only on the Tepan stainless steel grill CKT)
	E	Error
	Animations	▬ ▬ ▬
□ □ □		Cleaning (only on the Tepan stainless steel grill CKT)

Tab. 4.2 Meaning of the 7-segment display

4.1.4 Colour concept

INFO Fundamentally, all fan setting ranges are shown in blue and all cooking zone setting ranges are shown in red in the operating panel. Other colours are used for functions and messages.

List of all colour indicators:

Indicator	Fan (cooktop extractor)	Colour
	Slider	Blue
	Plus/Minus	Blue
	Fan symbol/automatic extractor function	Blue
Indicator	Cooking zones	Colour
	Slider	Red
	Plus/Minus	Red
	Cooking zone hot	Signal red
Indicator	Functions	Colour
	Switch animation on/off	Beige
	Set timer	Beige
Indicator	Messages	Colour
	Warnings	Orange
	Error	Signal red
	OK	Green

Tab. 4.3 Colour indicator

4.1.5 Lighting

INFO The operating panel has 4 different levels of lighting. (100%, 75%, 50% and 0%).

INFO On principle the system adapts the lighting to the current operating scenario. Relevant display elements are more brightly lit and irrelevant ones are dimmed. Unavailable functions are faded out.

Lighting	Use
100%	Function is active and selected
75%	Function is active but not selected
50%	Function is inactive and can be selected
0%	Function is unavailable

Tab. 4.4 Lighting

Example:

Fig. 4.4 Operating panel lighting

- [1] Active and selectable function (brightly lit, 75%)
 [2] Inactive but selectable function (dimmed, 50%)

4.1.6 Sounds

INFO The volume of the acoustic signals can be set in the menu (10% to 100%).

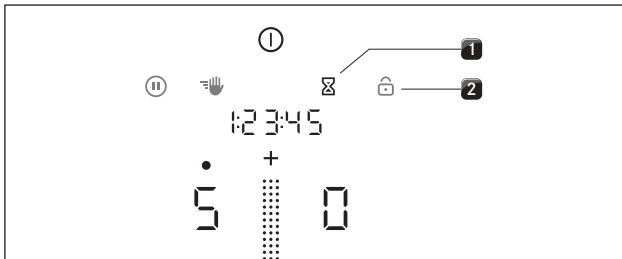
INFO Safety-relevant acoustic signals are always emitted with the volume at 100%.

The system basically differentiates between three different types of acoustic signals:

Acoustic signal	Purpose
Short individual beep (0.25 s)	Confirmation of a selection
Sequence of beeps	Interaction required
Long individual beep (0.75 s)	End of a function

Tab. 4.5 Sounds

4.1.7 System functions**Short-time timer (egg timer) **

The short-time timer emits both a visual and an acoustic signal after a time set by the user and offers the function of a conventional egg timer.

4.2 Cooktop extractor

INFO The cooktop extractor CKA2 is the central component and contains all of the electronics for operating the entire BORA Classic 2.0 system. It is not possible to operate the system or individual components without a cooktop extractor.

4.2.1 Model description

Model	Long description
CKA2	BORA Classic cooktop extractor flexible system with separate control unit, can be combined with the Classic cooktops and other BORA Universal components

Tab. 4.6 Model description

4.2.2 Installation variations

Depending on what you opted for when purchasing, the cooktop extractor can be operated as an exhaust air or an recirculating air version.

**Exhaust mode**

The air suctioned away is purified by the grease filter and expelled into the open air via a duct system.

The exhaust air must not be expelled into:

- a smoke or exhaust gas flue that is in operation
- a shaft used for the aeration of rooms where fireplaces are installed.

If the exhaust air is to be directed into a smoke or exhaust gas flue that is not in use, the installation must be checked and approved by the responsible heating engineer.

INFO If the cooktop extractor is used in an exhaust air system, the extractor power is automatically increased for the first 20 seconds when set on a lower power level (wall sleeve function).

**Recirculation mode**

The air suctioned away is purified by the grease filter and an activated carbon filter and fed back into the room in which the appliance is installed.

To prevent odours in recirculation mode, an odour filter must be used. For hygiene and health reasons, this must be replaced at the recommended intervals (see the Cleaning and maintenance chapter).

INFO In recirculation mode, ensure sufficient ventilation and aeration to expel humidity.

INFO If the cooktop extractor is used in a recirculating air system, when a power level is set the operating time is automatically deducted from the recirculation filter service life. The remaining filter service life can be seen in the menu under menu item A (see Operation chapter).

4.2.3 Overview of features and functions

Features	CKA2
Automatic fan detection	✓
Electronic power adjustment	✓
Interface communication	✓
Compact grease filter unit	✓
Functions	
Automatic after-run	✓
Power setting	✓
Automatic extractor function	✓
Filter service indicator (recirculation mode)	✓
Safety devices	
Control lock	✓
Safety shut-down	✓
active error monitoring	✓

Tab. 4.7 Overview of features and functions

4.2.4 Structure

Cooktop extractor CKA2

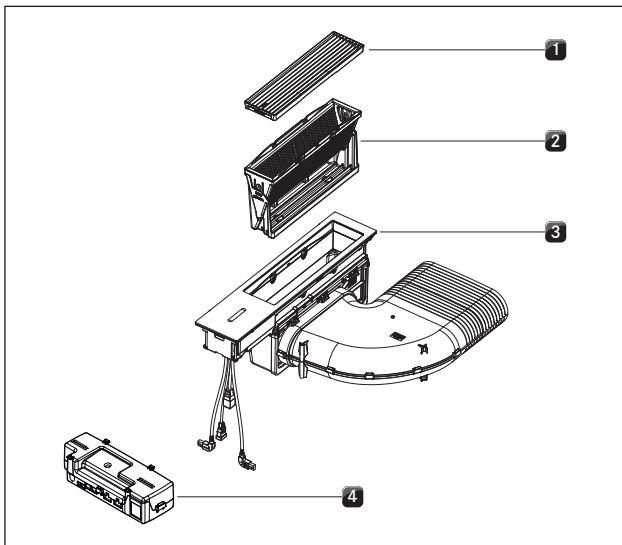

Fig. 4.5 BORA Classic cooktop extractor CKA2

- [1] Air inlet nozzle
- [2] Grease filter unit
- [3] Cooktop extractor
- [4] Control unit

4.2.5 Cooktop extractor functions

Power control

The power levels are adjusted via the operating panel by tapping or swiping movements on the touch slider. Alternatively the power levels can also be set using the touch buttons **+** and **-** above and below the touch slider.

Extractor power setting

When the power setting is activated, maximum extractor power is available for a predefined time.

This power setting makes it possible to suction away high levels of cooking vapours more quickly. After 10 minutes, the power setting is automatically switched to power level 5.

Automatic extractor control

The extractor power level automatically adjusts itself depending on the current cooktop settings. No manual adjustment of the fan controls is necessary but it is possible. The extractor power is automatically adjusted to the highest power level used on all cooking zones that are currently in use.

Function	Power levels									
Cooking level	1	2	3	4	5	6	7	8	9	P
Extractor power	3	3	3	4	4	4	5	5	5	P

Tab. 4.8 Extraction performance and cooking level

- A change in the power level of a cooking zone results in automatic adjustment of the extractor power after a delay of 20 seconds on induction cooktops and 30 seconds on all other cooktops.

Automatic after-run

The cooktop extractor continues to run at a lower level and switches off automatically after a defined time.



The duration of the after-run function can be set in the menu (10 to 30 minutes). The default duration of the after-run function is 20 minutes.

- When the extractor is switched off at the end of cooking the automatic after-run function is activated.
- Once the automatic after-run period has lapsed the cooktop extractor switches itself off.

INFO BORA expressly recommends use of the cooktop extractor after-run function.

Recirculation filter service indicator

The cooktop extractor filter service indicator is automatically activated when the end of the activated carbon filter service life is reached (only in recirculation mode).

- If the fan symbol  lights up yellow and the multi-function display **IFILT** appears after switching on the cooktop extractor, this is informing you that the filter needs to be changed soon.
- If the fan symbol  lights up in signal red and the error code **E F I L T** is shown in the multi-function display after switching on the cooktop extractor, the end of the filter service life has been reached and the filter must be replaced (also see Cleaning and Maintenance chapter).

INFO If the service life of the activated carbon filter is exceeded, the correct functioning of the system may be affected. It is still possible to use the cooktop extractor, however, all warranty and guarantee claims shall then be invalid for this appliance.

INFO Regardless of the filter service indicator, the components of the grease filter require regular cleaning (see Cleaning and Maintenance chapter).

4.2.6 USB interface

INFO The USB port is only designed for updates or data export and only has a power supply for these processes. It is not possible to charge devices or carry out other functions.

The system has a USB port. This port is only suitable for mass storage devices (USB sticks). These USB sticks must be formatted with the FAT32 data system.

4.2.7 Interface for external devices

The internal interface can be used for extended control options. This has a Home In and a Home Out contact (see Installation chapter).

- The Home In contact can be used for the signal input from external switch devices (e.g. window contact switch).
- The Home Out contact can be used to control external installations.

4.3 Cooktops

INFO The cooktops CKFI, CKI, CKIW, CKCH, CKCB, CKG and CKT are the variable components for the BORA Classic 2.0 system and can only be operated in conjunction with cooktop extractor CKA2.

INFO You can see exactly which devices have been installed in your system on the penultimate page of the Operating instructions (see Identification plates chapter).

4.3.1 Model description

Model	Long description
CKFI	BORA Classic surface induction glass ceramic cooktop with 2 cooking zones
CKI	BORA Classic induction glass ceramic cooktop with 2 cooking zones
CKIW	BORA Classic induction glass ceramic wok
CKCH	BORA Classic Hyper glass ceramic cooktop with 2 cooking zones 1-ring/2-rings
CKCB	BORA Classic HiLight glass ceramic cooktop with 2 cooking zones 1-ring/2-ring/roaster
CKG	BORA Classic gas glass ceramic cooktop with 2 cooking zones
CKT	BORA Classic Tepan stainless steel grill with 2 cooking zones

Tab. 4.9 Model description

4.3.2 Overview of features and functions

The BORA Classic 2.0 cooktops have the following features and functions:

Features	CKFI	CKI	CKIW	CKCH	CKCB	CKT	CKG
Electronic power adjustment	✓	✓	✓	✓	✓	✓	✓
Power setting	✓	✓	✓	✓*		✓	✓
Egg timer function (short-time timer)	✓	✓	✓	✓	✓	✓	✓
Automatic ignition and autom. reignition							✓
Electronic gas adjustment system (e-gas system)							✓
Cooking functions							
Automatic heat up function	✓	✓	✓	✓	✓		✓
Pan size recognition	✓	✓	✓				
Warming	✓	✓	✓	✓	✓	✓	✓
Bridging function	✓				✓	✓	
Timer function	✓	✓	✓	✓	✓		✓
Pause function	✓	✓	✓	✓	✓	✓	✓
2-ring additional switching (rear cooking zone)				✓	✓		
Cleaning lock (wipe function)	✓	✓	✓	✓	✓	✓	✓
Cleaning function						✓	
Safety devices							
Childproofing feature	✓	✓	✓	✓	✓	✓	✓
Residual heat indicator	✓	✓	✓	✓	✓	✓	✓
Safety shut-down	✓	✓	✓	✓	✓	✓	✓
Overheating protection	✓	✓	✓	✓	✓	✓	✓

Tab. 4.10 Function overview

*only applies to the front cooking zone

4.3.3 Structure

Cooktop CKFI

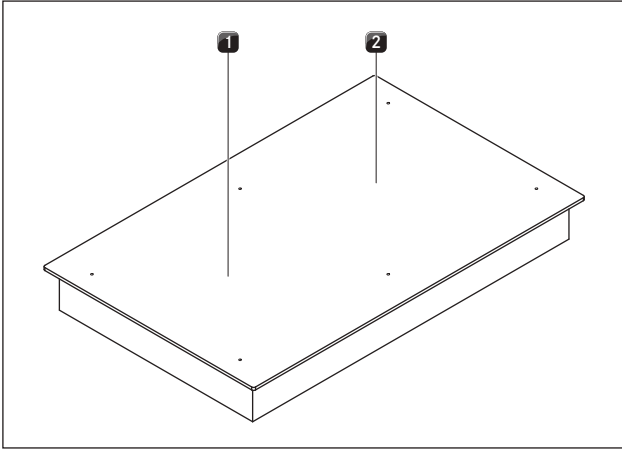

Fig. 4.6 BORA Classic cooktop CKFI

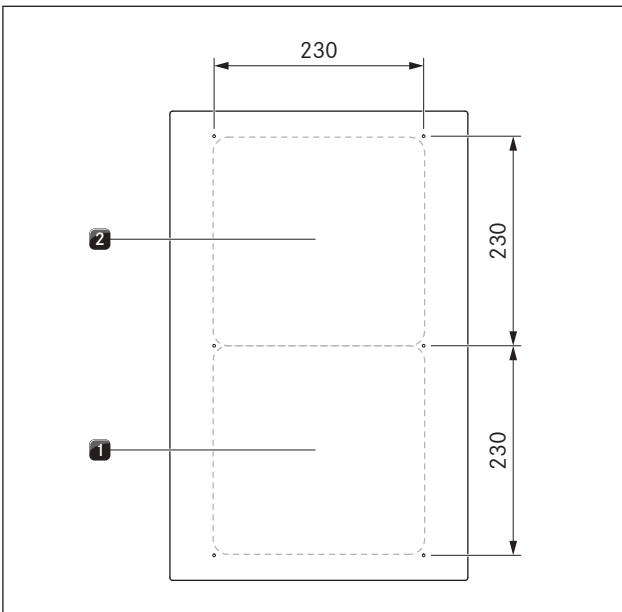

Fig. 4.7 Size of the cooking zones

- [1] Surface induction front cooking zone (zone 1)
2100 W (power setting 3680 W)
- [2] Surface induction rear cooking zone (zone 2)
2100 W (power setting 3680 W)

Cooktop CKI

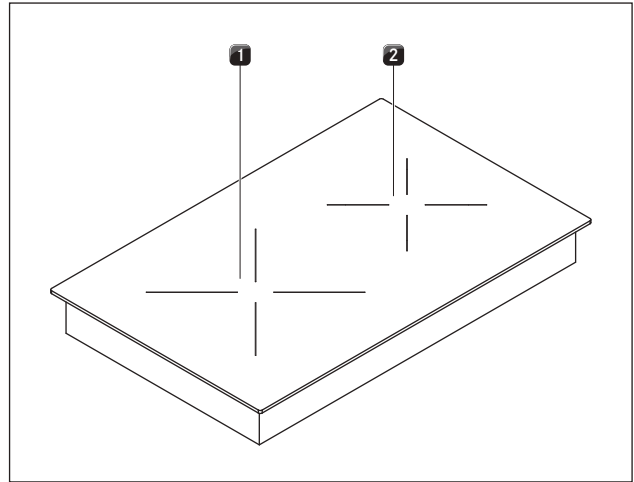

Fig. 4.8 BORA Classic cooktop CKI

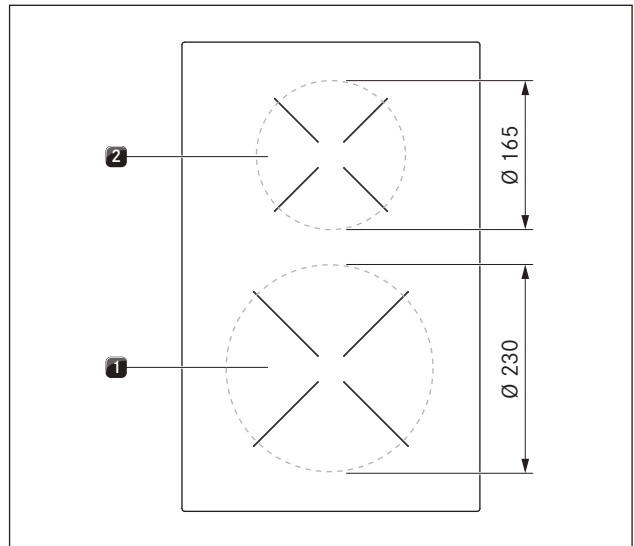

Fig. 4.9 Size of the cooking zones

- [1] Induction front cooking zone (zone 1)
2300 W (power setting 3680 W)
- [2] Induction rear cooking zone (zone 2)
1400 W (power setting 2200 W)

Cooktop CKIW

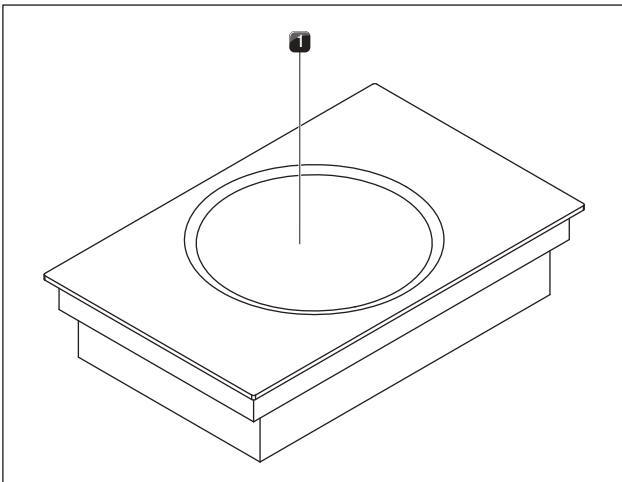

Fig. 4.10 BORA Classic cooktop CKIW

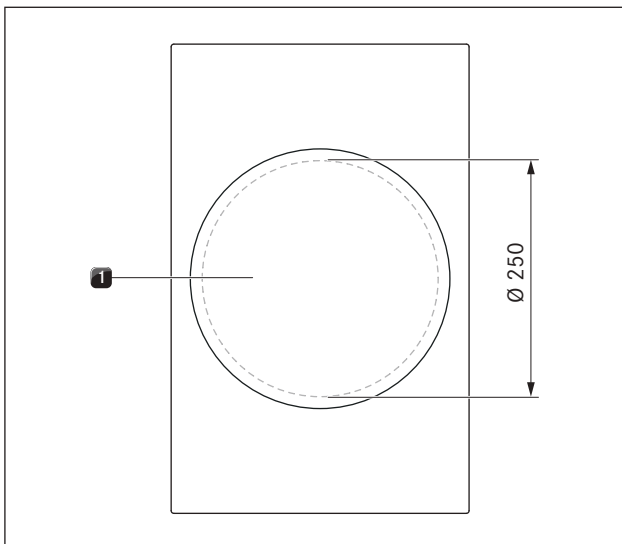

Fig. 4.11 Size of the cooking zone

- [1] Induction wok cooking zone
2400 W (power setting 3000 W)

Cooktop CKCH

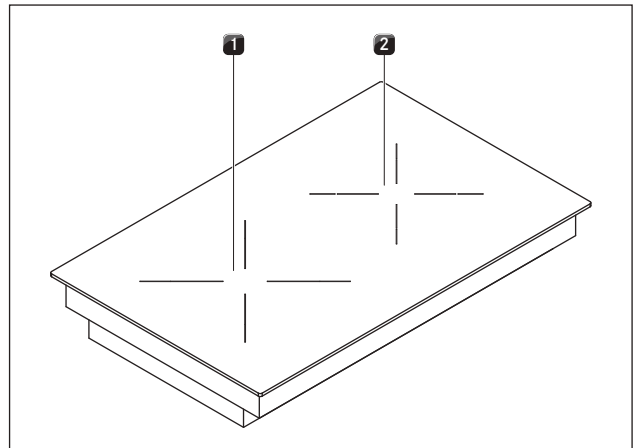

Fig. 4.12 BORA Classic cooktop CKCH

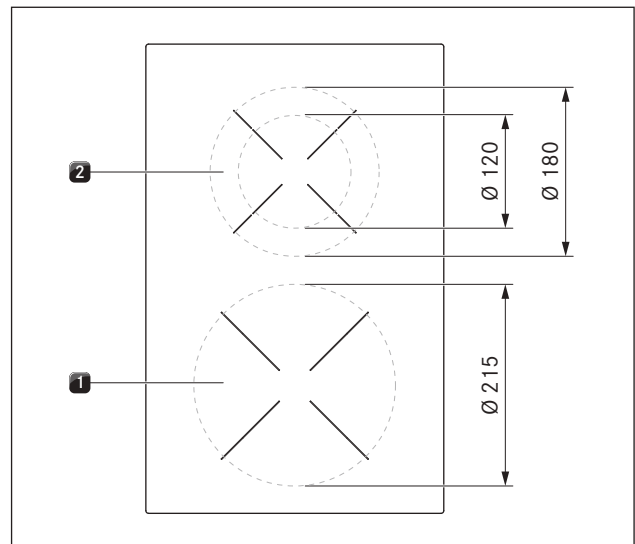

Fig. 4.13 Size of the cooking zones

- [1] Hyper front cooking zone (zone 1)
2100 W (power setting 3000 W)
[2] 2-ring rear cooking zone (zone 2)
600 W (2-ring connection 1600 W)

Cooktop CKCB

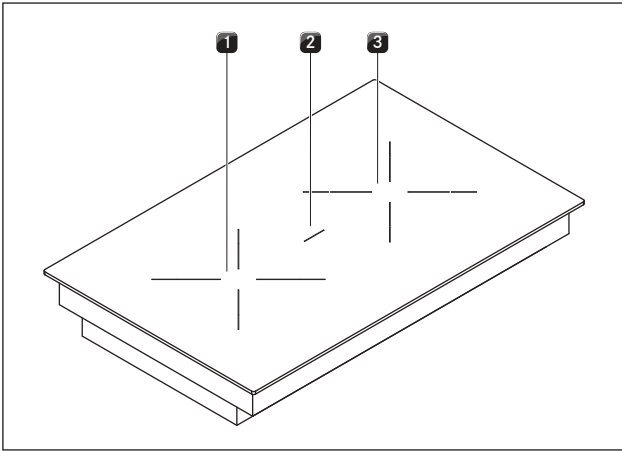

Fig. 4.14 BORA Classic cooktop CKCB

Cooktop CKG

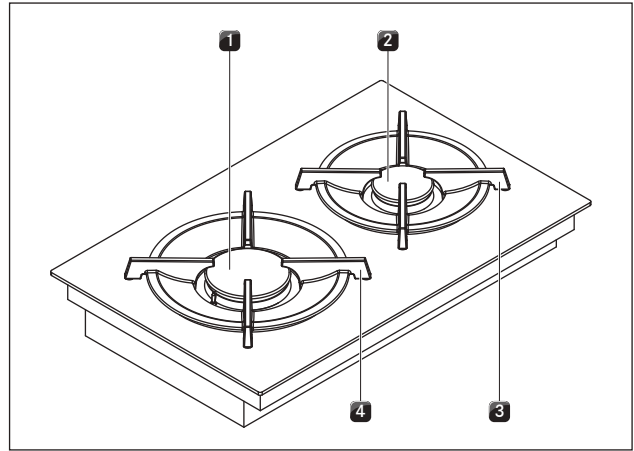

Fig. 4.16 BORA Classic gas glass ceramic cooktop CKG

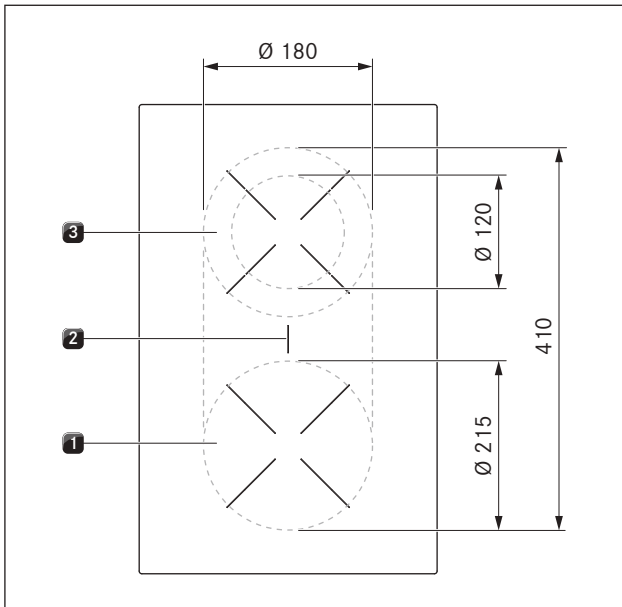

Fig. 4.15 Size of the cooking zones

- [1] Front cooking zone (zone 1)
1600 W
- [2] Roaster cooking zone
3680 W
- [3] 2-ring rear cooking zone (zone 2)
600 W (2-ring connection 1600 W)

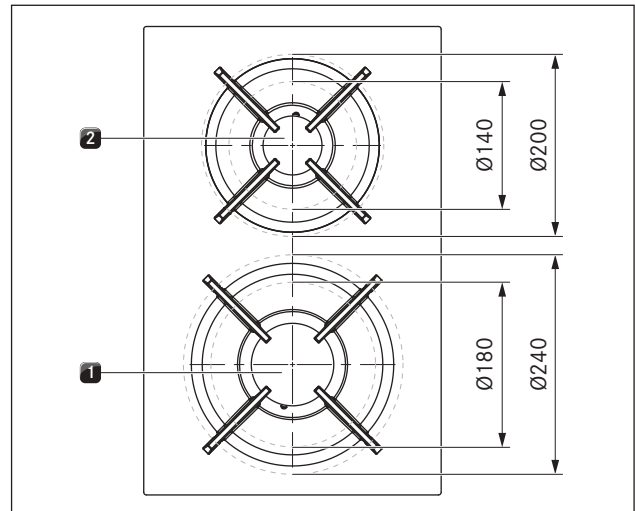

Fig. 4.17 Size of the cooking zones

- [1] High-power front burner 3000 W
- [2] Normal rear burner 2000 W
- [3] Pan support rear
- [4] Pan support front

Cooktop CKT

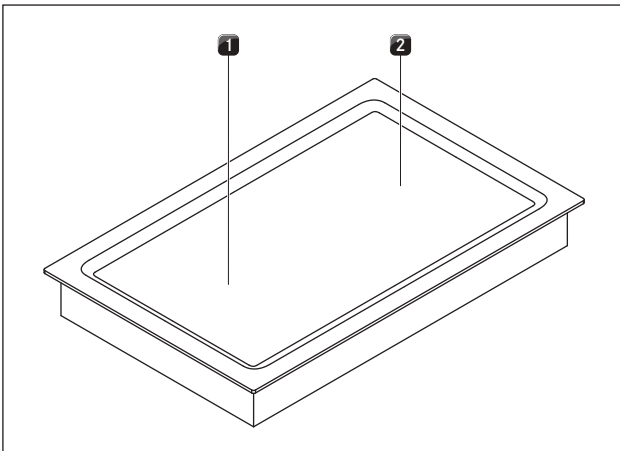

Fig. 4.18 BORA Classic Tepan stainless steel grill CKT

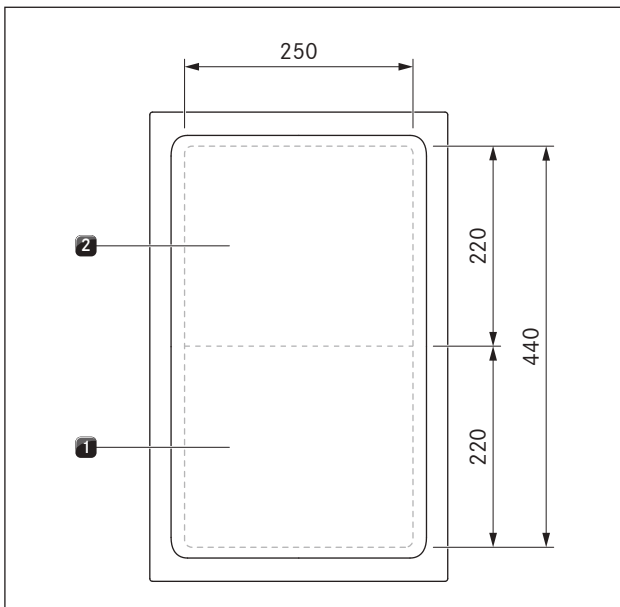

Fig. 4.19 Size of the cooking zones

- [1] Front grilling zone (zone 1)
1750 W
- [2] Rear grilling zone (zone 2)
1750 W

4.3.4 How the Induction cooktops work (CKFI, CKI, CKIW)

An induction coil is located underneath an induction cooking zone. If the cooking zone is switched on, this coil creates a magnetic field that acts directly on the base of the pot thus heating it up. The cooking zone is only indirectly heated up by the heat emitted by the pot. Cooking zones with induction only work if the cookware has a magnetisable base.

Induction automatically takes into account the size of the used cookware which means that only the area in the cooking zone covered by the base of the pot is heated up.

► Observe the minimum pot base diameter.

Power levels

The high power output of induction cooktops results in the very quick heating up of cookware. A slight adjustment is needed in comparison to conventional cooking systems when selecting the power level in order to avoid burning food.

Activity	Power level
Melting of butter and chocolate, breaking up gelatine	1
Keeping sauces and soups warm, soaking rice	1-3
Cooking potatoes, pasta, soups, ragouts, steaming fruit, vegetables and fish, defrosting food	2-6
Frying in coated pans, moderate frying (without overheating the fat) of pork cutlets, fish	6-7
Heating up fat, browning fish, cooking thickened sources and soups, making omelettes	7-8
Bringing large amounts of liquid to the boil, searing steaks	9
Heating water	P

Tab. 4.11 Recommendations for power levels

The specifications provided in the table are standard values.

Depending on the cookware and filling quantity, it is recommended to either decrease or increase the power level.

Suitable cookware

INFO The heating and heat through time for the base of the cookware as well as the cooking results are significantly influenced by the structure and material of the cookware.



Cookware with this symbol is suitable for induction cooktops. The cookware used for the induction cooktop must be made of metal, feature magnetic properties and possess a sufficient bottom surface.

Suitable cookware is made of:

- stainless steel with a magnetisable base
- enamelled steel
- cast iron

Appliance	Cooking zone	Minimum diameter
CKFI	Front	120 mm
	rear	120 mm
CKI	Front	120 mm
	rear	90 mm
CKIW	Wok	210 mm

Tab. 4.12 Minimum cookware diameter

INFO The BORA induction wok pan HIW1 is ideal for the induction wok cooktop CKIW and is available as an accessory.

- ▶ Perform a magnet test, if necessary. If a magnet sticks to the base of the utensils, they are normally induction compatible.
- ▶ Pay attention to the cookware bottom. The base of the cookware should not show any sign of curvature (exception: wok cooktop CKIW). Due to incorrect temperature monitoring of the hob caused by the air gap between the cookware and the temperature sensor underneath the hob, overheating may occur. The bottom of the cookware must not have any sharp grooves or sharp edges to avoid scratching the cooktop.
- ▶ Place the cookware (without a mat or similar) directly onto the glass ceramic.

Noises

The following noises may occur in the cookware when using induction cooking zones, depending on the material and the finish of the base:

- Humming may occur when using a high power level. It decreases or disappears if the power level is decreased.
- Crackling or whistling may occur due to the bases of cookware being made of different materials (e.g. sandwich base).
- Clicking sounds may occur during electronic switching procedures especially at low power levels.
- Whirring may occur when the cooling fan is switched on. In order to increase the service life of the electronic system, the cooktop is equipped with a cooling fan. The cooling fan switches on automatically if the cooktop is used intensively. You will hear a whirring sound. The cooling fan may continue to run after the appliance has been switched off.

4.3.5 How the Hyper and HiLight cooktops work (CKCH, CKCB)

Under the cooking zone is a radiant heating element with a heating tape. When the cooking zone is switched on, the heating tape generates radiant heat, which radiates to the cooking zone and heats it up.

Power levels

Activity	Power level
Melting of butter and chocolate, breaking up gelatine	1
Keeping sauces and soups warm, soaking rice	1-3
Cooking potatoes, pasta, soups, ragouts, steaming fruit, vegetables and fish, defrosting food	2-6
Frying in coated pans, moderate frying (without overheating the fat) of pork cutlets, fish	6-7
Heating up fat, browning fish, cooking thickened sources and soups, making omelettes	7-8
Cooking large amounts of liquids, grilling steaks and heating water	9
Grilling steaks and heating up water	P

Tab. 4.13 Recommendations for power levels

The specifications provided in the table are standard values.

Depending on the cookware and filling quantity, it is recommended to either decrease or increase the power level.

Power setting on cooktop CKCH

The front cooking zone on the Hyper glass ceramic cooktop CKCH is fitted with a temporary power setting.

■ P appears in the operating panel display.

The power setting can be used in order to quickly heat up large quantities of water. If the power setting is activated, the cooking zones will run at extra high power. After 10 minutes, the cooking zone is automatically switched back to power level 9.

Suitable cookware

INFO The heating and heat through time for the base of the cookware as well as the cooking results are significantly influenced by the structure and material of the cookware.



Cookware with this symbol is suitable for radiant heating elements. The cookware used for radiant heating surfaces must be metal and have good heat conducting properties.

Suitable cookware is made of:

- stainless steel, copper or aluminium
- enamelled steel
- cast iron

- ▶ Pay attention to the cookware bottom. The base of the cookware should not show any sign of curvature. Due to incorrect temperature monitoring of the hob caused by the air gap between the cookware and the temperature sensor underneath the hob, overheating may occur. The bottom of the cookware must not have any sharp grooves or sharp edges to avoid scratching the cooktop.
- ▶ Place the cookware (without a mat or similar) directly onto the glass ceramic.

4.3.6 How gas glass ceramic cooktop CKG works

INFO The cooktop has automatic ignition.

If a cooking zone is switched on, the gas flame generates heat, which directly heats the base of the cookware. The gas flame is controlled by a highly accurate electronic gas control system (E-gas system). Among other things, servomotors are used to accurately control each gas burner. These servomotors calibrate themselves from time to time and typical humming noises can be heard that are totally normal and do not constitute a malfunction.

The advantage of this electronic gas control system is the optimum, repeatable heat regulation, which means that the selected power levels are identical in every cooking session. In addition, a clean, constantly increasing flame is formed at every power level. Furthermore, if necessary, it can be automatically reignited.

Power levels

The power is adjusted using power levels 1 – 9 and P. The output of gas cooktops means that food is heated quickly. A slight adjustment is needed in comparison to conventional cooking systems when selecting the power level in order to avoid burning food.

Activity	Power levels
Keeping cooked meals warm	1-2
Browning chopped vegetables, fried eggs, veal, poultry	3-5
Grilling prawns, corn on the cob, schnitzel, beef, fish or burgers	5-7
Bringing large amounts of liquid to the boil, searing steaks	8-9
Heating water	P

Tab. 4.14 Recommendations for power levels

The specifications provided in the table are standard values.

INFO Each gas cooking zone is equipped with a safety thermocouple. This element detects if the flame has gone out (e.g. if a pan has boiled over or there is a strong draught). The gas supply is then turned off and the burner is automatically reignited. If reignition is not possible, the gas supply is stopped. A gas leak is therefore prevented.

Suitable cookware



Cookware with this symbol is suitable for gas cooktops.

INFO The heating and heat through time for the base of the cookware as well as the cooking results are significantly influenced by the structure and material of the cookware. Cookware with a thick base ensures more even heat distribution. In the case of a thin base there is a risk of the food becoming overheated in places. The cooktop may also become damaged.

INFO Take special care not to overheat the cookware as the base can become deformed. For this reason, you should never heat up cookware when empty.

INFO Cookware with an uneven base may tip over. A slight wobble can never be completely ruled out.

Suitable cookware is made of:

- copper
- stainless steel
- aluminium
- cast iron

▶ Adhere to the dimensions in the table:

Burner	Minimum pan diameter	Recommended pan diameter
Normal burner	120 mm	140-200 mm
High-power burner	160 mm	180-240 mm

Tab. 4.15 Pan diameters

INFO Only use cookware with a diameter that is within the given dimensions. If the diameter is too large, the hot gases flowing outwards from under the base may damage the worktop or any non-heat-resistant wall, e.g. with panelling, as well as part of the cooktop and the cooktop extractor. Bora shall not be held liable for any such damages.

4.3.7 How the Tepan stainless steel grill CKT works

Under each grilling area there is a heating element. When a grilling zone is switched on, the heating element generates heat that heats up the grill surface directly.

Power levels and temperature ranges

The power is adjusted via power levels that are also shown in the operating panel display in °C (temperature display).

Power level		Temperature in °C
1	=	150
2	=	160
3	=	170
4	=	180
5	=	190
6	=	200
7	=	210
8	=	220
9	=	230
P (power setting)	=	250

Tab. 4.16 The temperatures corresponding to the power levels

The power output of the Tepan stainless steel grill heats food extremely quickly. A slight adjustment is needed in comparison to conventional cooking systems when selecting the temperature in order to avoid burning food.

Activity	Temperature in °C
Steaming fruit, e.g. apple slices, peach halves, banana slices	160 – 170
Browning chopped vegetables, fried eggs, veal, poultry	180 – 190
Browning breaded or battered fish, pancakes, sausages, pork, lamb	190 – 200
Browning potato fritters, prawns, corn on the cob and escalopes	200 – 210
Fast browning beef, fish, meatballs	220 – 230
Browning steaks	250 (power setting)

Tab. 4.17 Temperature recommendations (the specifications provided in the table are standard values)

4.3.8 Cooktop functions

Power control

The power levels are adjusted via the operating panel by tapping or swiping movements on the touch slider. Alternatively the power levels can also be set using the touch buttons **+** and **-** above and below the touch slider.

Cooktop power setting

When the power setting is activated, maximum cooking zone power is available for a predefined time. The available power is focused on the selected cooking zone, meaning that the max. power of the other cooking zones is automatically and temporarily reduced.

After 10 minutes, the cooking zone is automatically switched back to power level 9.

INFO Never heat up oil, fat and the like on the power setting. The bottom of the pan can overheat due to the high power output.

2-ring additional switching

A second, larger ring can be easily switched on. This enables rapid adjustment to the cookware used.

Automatic heat up function

When the automatic heat up function is activated, the cooking zone works at full power for a certain time and is then automatically reset to the previously set level.

Power level (continuous cooking level)	Cooking duration in min:sec	
	Cooktops CKFI, CKI, CKIW, CKG	Cooktops CKCH, CHCB
1	00:40	01:00
2	01:00	03:00
3	02:00	04:48
4	03:00	06:30
5	04:20	08:30
6	07:00	02:30
7	02:00	03:30
8	03:00	04:30

Tab. 4.18 Heating time overview

Variable warming function

With the 3 warming levels, meals that have already been cooked can be kept warm at a constant temperature without any risk of burning.

■ The maximum duration for the warming function is limited to 8 hours.

There are three different warming levels:

Warming level	Symbol	Temperature	
1	-	≈ 42 °C	(90 °C in the case of CKT)
2	=	≈ 74 °C	(110 °C in the case of CKT)
3	≡	≈ 94 °C	(130 °C in the case of CKT)

Tab. 4.19 Warming levels

INFO In practice the temperatures of the warming levels may vary slightly as they are influenced by the cookware, the amount of food and the different heating technologies. The temperatures can also vary due to the influence of the cooktop extractor.

Bridging function

With the bridging function two cooking zones can be combined to form one large cooking zone. The power for the combined zones is then adjusted by a single operating control. Power adjustment takes place simultaneously (both cooking zones are operated on the same power level).

The bridging function is suitable for heating food, e.g. in a roaster.

Pan size recognition on induction cooktops

The cooking zone automatically detects the size of the cookware and only focuses the energy on that area. It also recognises cookware that is unsuitable or too small or if there is no cookware present.

A cooking zone is not working if  is flashing in the display. This happens if...

- ...it is switched on without cookware or with unsuitable cookware.
- ...the base diameter of the cookware is too small.
- ...the cookware is removed from a cooking zone that is switched on.

If no pot is recognised 9 minutes after setting a power level, the cooking zone will switch off automatically.

Cooking zone timer (automatic cut-off)

When cooking zones are in operation, the automatic cut-off function automatically switches off the selected cooking zone once a preset time has lapsed.

If the selected cooking zone is not active when the timer is started, only an acoustic signal will be heard when the time has lapsed.

The timer function can be used on up to 4 cooking zones (multi-timer).

Pause function

With the pause function all cooking zones can be quickly and easily deactivated temporarily. When the function is cancelled, operation resumes at the original settings.

The cooking session can be paused for max. 10 minutes. Once 10 minutes have lapsed, all cooking sessions are automatically ended.

Cleaning function on the Tepan stainless steel grill

The cleaning function adjusts the Tepan stainless steel grill to a constant temperature of 70 °C, which is perfect for cleaning. This temperature is then maintained for 10 minutes.

4.4 Safety devices

4.4.1 Control lock

The control lock prevents unintentional use of the cooktop extractor and cooktops during operation.

- If the control lock is active, the symbol  lights up.
- The functions are locked and the indicators on the display are dimmed (exception: power button).

4.4.2 Cleaning lock (wipe function)

The cleaning lock prevents settings from being changed when wiping the operating panel during a cooking session. Upon activation the operating panel is locked for a certain time (factory setting 15 seconds). The remaining time is displayed. All appliance settings remain unchanged in the meantime.

The duration of the wiping time can be set in the menu (5 – 30 seconds).

INFO If the operating panel is cleaned with a damp cloth, a film of water may form and the power button may be triggered despite the cleaning lock being activated. This can be corrected by drying the panel immediately after cleaning.

4.4.3 Safety shut-down

If the appliance is switched on but not used for 2 minutes, it will automatically switch off (standby mode).

Cooktop extractor

The cooktop extractor will be automatically switched off 30 minutes after all cooking zones have become inactive (= power level 0) and the automatic after-run function will be started.

Cooktops

Each cooking zone is automatically switched off after a predefined operating time in which the power level has not been changed.

Power levels	Safety shut-down after hrs:min		
	Cooktops CKFI, CKI, CKIW, CKT	Cooktops CKCH, CKCB	Cooktop CKG
1	08:24	06:00	08:24
2	06:24	06:00	06:24
3	05:12	05:00	05:12
4	04:12	05:00	04:12
5	03:18	04:00	03:18
6	02:12	01:30	02:12
7	02:12	01:30	02:12
8	01:48	01:30	01:48
9	01:18	01:30	01:18
P	00:10	0:10 (only in the case of CKCH)	00:20

Tab. 4.20 Safety shut-down for power levels

Warming level	Safety shut-down after hrs:min
1 (-)	08:00
2 (=)	08:00
3 (̄)	08:00

Tab. 4.21 Safety shut-down for warming levels

- Switch the cooking zone back on if you want to put the cooking zone back into operation (see Operation chapter).

4.4.4 Residual heat indicator *H*

If a cooking or grilling zone is still hot after switching off, there is a risk of burns or fire. Whilst the hot symbol  and *H* are displayed (residual heat indicator), you must not touch that cooking or grilling zone or place any heat-sensitive objects on it. After a sufficient cooling period (< 50 °C) the indicators will go out.

INFO During or after a power cut, the cooktops may still be hot. In the case of the cooktops CKCH, CKCB and CKG, no residual heat is displayed after a power cut, even if they were in use beforehand and the hobs are still hot.

4.4.5 Overheating protection

INFO If a cooktop overheats, its power is reduced or it is switched off completely.

INFO If the operating panel overheats, cooktops or the whole system may be switched off.

The appliances are fitted with overheating protection. The overheating protection can be triggered if...

- ... cookware is heated up empty.
- ... oil or fat is heated on high power.
- ...a hot cooking zone is switched on again after a power cut.
- ...hot cookware heats up the operating panel.

Whilst the overheating protection is active, one of the following steps is taken:

- The activated power setting is switched back to the previous level.
- The set power level is reduced.
- The cooking zone switches off completely.
- The cooktop switches off completely.
- The system switches off completely.

After a sufficient cooling period, the appliance can be used again in full.

4.4.6 Childproofing feature

The childproofing feature prevents the appliance from being switched on accidentally or without permission.

5 Initial operation

Special requirements for initial operation of gas cooktop CKG:

INFO Minimum requirement for operating gas cooktop CKG: system software 03.00 (or higher)

- ▶ If necessary, retrieve the installed software version (see Menu chapter, Retrieving the software version).
- ▶ Update the system software if necessary (see Menu chapter, Updating the system software)

5.1 Basic configuration

INFO When used for the first time, the system must be configured. It is absolutely essential to go through the three menu items of the basic configuration from start to finish.

INFO *CONF* is shown in the display and the fan symbol flashes red to indicate that the basic configuration is incomplete.

INFO If this process is interrupted before it is completed, the basic configuration must be continued from where you left off the next time the menu is called up.

INFO If the basic configuration has not been completed successfully, the corresponding request will be repeated every time the menu is called up.

INFO If a menu item is called up, after 2 seconds the system automatically shows the current set value. Exception: If no settings have been made, the system displays *SEt*.

INFO The system adopts and saves the settings made when you exit the corresponding menu item or when you exit the menu.

INFO You can find a video guide on basic configuration on the BORA website.

Scan the QR code or follow this link:

www.bora.com/service/configuration-classic-2-0



5.1.1 Carrying out the basic configuration

Starting basic configuration

- ▶ Tap the flashing red fan symbol 
- The menu is called up and the first item in the basic configuration menu is displayed (menu item H).
- ▶ Enter the settings.

Aborting the basic configuration manually

- ▶ Long press on the menu button

If you wish to abort the basic configuration process ahead of time, e.g. because fans are not correctly recognised, all menu items that have not been fully completed must be run through again at a later date.

5.1.2 Menu item H: Air Extraction system configuration

INFO The extraction system operating mode must be set.

There are two operating modes to choose from:

- Exhaust air system (*OUT*)
- Recirculation system (*REC*)

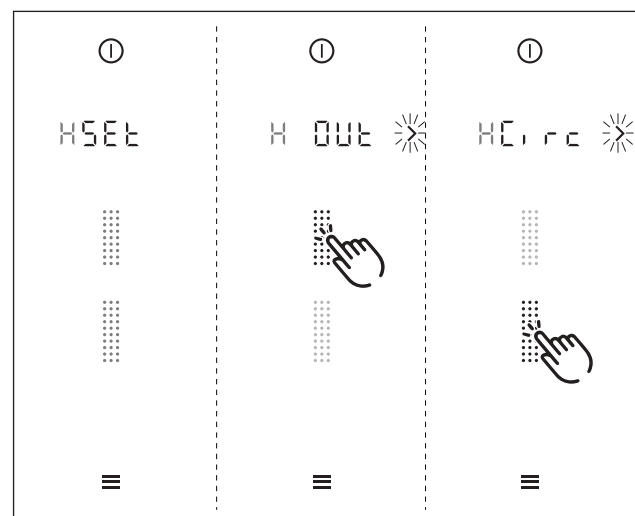



Fig. 5.1 Configuring the exhaust air system display

- ▶ Select the corresponding operating mode (tap the corresponding segment on the slider .

- ▶ Confirm and save the setting by moving to the next menu item (tap the flashing navigation arrow .

5.1.3 Menu item J: *FŁYP* Select the filter type (only in the case of recirculation)

INFO Menu item J only appears if the “recirculation system” operating mode has been selected during configuration of the extraction system.

The type of filter installed must be defined.
There are two different filters to choose from:

- Filter type 1 (*F1*)= BORA air cleaning box ULB1/ULBF
- Filter type 2 (*F3*)= BORA air cleaning box ULB3

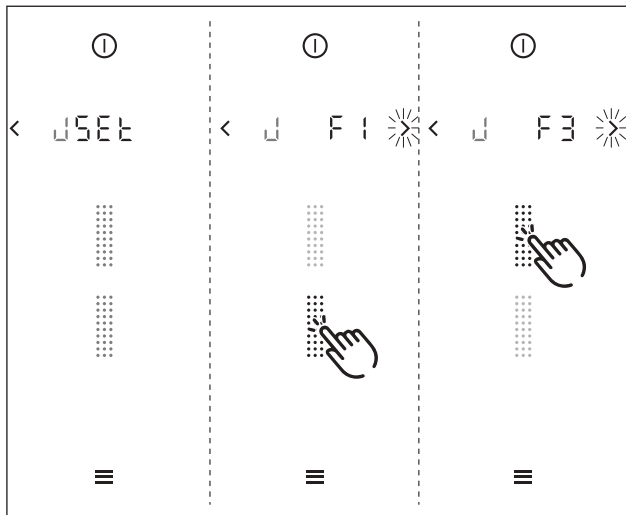



Fig. 5.2 Selecting the filter type display

- ▶ Select the type of filter installed (tap the corresponding segment on the slider .
- ▶ Confirm and save the setting by moving to the next menu item (tap the flashing navigation arrow .

INFO For recirculation filters from other manufacturers filter type 1 (*F1*) must be selected.

5.1.4 Menu item L: *FAN* Fan configuration

INFO During fan configuration the type of fan installed and the number of fans are automatically recognised by the system and the configuration is adjusted accordingly. During initial operation it is necessary for the installer to check that the fans have been recognised correctly.

Starting fan configuration

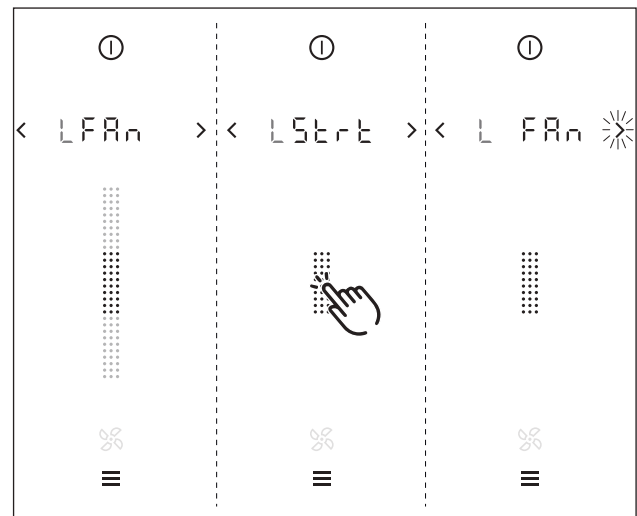







Fig. 5.3 Starting fan configuration display

- ▶ Touch the slider 
- Fan configuration is started.
- During fan configuration the slider interface and the fan symbol will flash.



INFO When fan configuration is complete, the display will stop flashing.

INFO If fan configuration was successful, the slider interface  and the fan symbol  will turn green.

INFO If fan configuration was not successful, the slider interface  and the fan symbol  will turn red.

Checking fan recognition

- ▶ Check that the system has recognised all fans correctly.

Indicator	Colour	Result
	green	1 fan recognised
	green	2 fans recognised
	red	0 fans recognised, error (see Troubleshooting chapter)

Tab. 5.1 Possible results of the fan recognition

INFO If a window contact switch is connected during fan recognition, it must be taken into account that this will also give approval (window open).

5.1.5 Completing basic configuration

When you have successfully completed all of the steps in the basic configuration menu:

- ▶ tap the flashing navigation button 
- The system adopts and saves the settings made and the standard display is shown.

6 Operation

- Observe all safety and warning information during operation (see Safety chapter).

INFO The cooktops on the BORA Classic 2.0 system can only be operated in conjunction with cooktop extractor CKA2.

INFO The cooktop extractor must only be operated when the grease filter components are installed.

6.1 General and specific operating instructions

The cooktop extractor and cooktops are operated via a central operating panel. The operating panel is fitted with electronic sensor buttons and display panels. The sensor buttons respond to finger contact (see Appliance description chapter).

You operate the appliance by tapping the corresponding sensor button with your finger (touch control) or by a swipe of your finger (slider operation).

INFO Not all symbols are displayed on all appliances. Functions and indicators are authorised corresponding to the installed appliances.

6.1.1 Special operating instructions for the Tepan stainless steel grill CKT

Initial operation:

- Heat the griddle to 220 °C for approx. 25 minutes before using it for the first time (= power level 8 for both grilling zones).

INFO Bothersome odours may be emitted during this process.

Operating instructions:

INFO Clean the grill surface before using the appliance for the first time (see Cleaning chapter).

INFO Preheat the grilling zone for 5 minutes before it is used each time.

INFO During heating or cooling the griddle may make some noise. This is a normal occurrence.

INFO A fan is built in to the Tepan stainless steel grill for cooling, guaranteeing a long service life for the electronic components and rapid cooling of the grill surface. Different measures have been taken to keep noise to a minimum, but it cannot be completely avoided.

INFO During use, the griddle may show signs of curvature.

INFO During grilling or heating on a high power level, the griddle may adopt a light brown colour.

6.1.2 Special operating instructions for gas glass ceramic cooktop CKG

INFO Minimum requirement for operating gas cooktop CKG: system software 03.00 (or higher)

INFO Clean the cooking zone before using the cooktop for the first time (see the Cleaning chapter).

INFO When operating the cooktop for the first time or after a prolonged period without use or when the liquid gas bottles have been changed, it is possible that the burner may not ignite. This may be due to air in the gas pipe or the electronic gas regulator may need recalibrating. Follow the initial operation instructions (see Initial operation chapter).

INFO Due to the use of enamelled cast iron parts, slight colour variations and irregularities are common. Furthermore, flash rust may appear at the support points, which can be easily removed with a damp cloth. These spots are normal and are not considered an impairment.

INFO As a result of use, some of the components of the gas cooktop can become discoloured. This discolouration is normal and does not have a negative effect on the gas flame or the functioning of the cooktop.

INFO When using the gas burner, you may hear gas escaping from it. The burner flame turns orange as a result of prolonged operation and/or impurities on the burner and in the ambient air (dust). These properties are normal and can occur independently of one another.

INFO In the event of smoke or fire while operating the gas cooktop, turn off the gas supply and switch off the appliance at the wall socket.

INFO If you smell gas or have problems with the gas installation, switch off the gas supply. Open the window and ensure good ventilation.

Operating instructions:

The use of a gas cooktop results in the formation of heat and moisture in the area where it is installed. Intensive use of the appliance for a long time may require the use of additional ventilation, e.g. opening a window or more effective ventilation, e.g. operation of the mechanical ventilation device at a higher power level.

- ▶ Ensure sufficient ventilation.
 - ▶ Keep natural ventilation openings open.
 - ▶ Use a mechanical ventilation device if possible.
-

INFO Only use cookware with a diameter that is within the recommended dimensions (see 'suitable cookware' in the Appliance description chapter). If the diameter is too large, the hot gases and flames flowing outwards from under the base may damage the worktop or any non-heat-resistant surfaces, e.g. walls with panelling, as well as parts of the cooktop and the cooktop extractor. BORA shall not be held liable for any such damage.

INFO Do not use the gas cooktop without cookware for extended periods of time (>5 min) with the cooktop extractor switched on. This results in very high temperatures and may damage the gas cooktop and air-channelling components of the cooktop extractor.

INFO The tips of the flames should remain under the base of the pot. Protruding flame tips emit heat into the air unnecessarily and can damage pan handles and air-channelling components (cooktop extractor) and increase the risk of burns. Furthermore, the outer part of the gas flame is much hotter than the core.

INFO Protect your hands when the appliance is hot by using oven gloves or pot holders. Only use dry gloves or pot holders. Wet or damp fabrics conduct heat more easily and can cause steam burns. Ensure that these fabrics do not get too close to the flames. Do not use oversized pot holders, tea towels or similar.

INFO Grease splashes and other flammable (food) residues on the cooktop can catch fire. Remove them as soon as possible.

- ▶ Do not put cookware with an uneven base on the pan support.
- ▶ Never heat empty cookware.
- ▶ Always place the cookware on the pan support provided. Cookware must not be placed directly on the burner.
- ▶ Do not use roasters, pans or stone grills that are so large that they cover several burners. The resulting heat accumulation can damage the cooktop.
- ▶ Ensure that the burner parts and pan supports are positioned correctly.
- ▶ Do not switch the gas cooktop on until all burner parts are correctly assembled.
- ▶ Ensure that the burner flame does not protrude from under the base of the cookware and rise up the outside of the pot.
- ▶ Do not keep any highly flammable objects near the cooktop.

For maximum performance with minimum gas consumption, we recommend that you:

- ▶ use cookware with a base that covers the flame entirely so that this does not burn beyond the base;
- ▶ use suitable pans on each gas burner;
- ▶ position the cookware centrally on the gas hob;
- ▶ set the gas burner to the lowest power level (small flame) once the pan contents are simmering;
- ▶ adjust the power level of the cooktop extractor to the power level of the gas cooktop.

Using the gas cooktop with a cooktop extractor

If the gas cooktop is used together with a cooktop extractor, the airflow of the extractor can affect the gas flame.

- ▶ Avoid using a high power level on the cooktop extractor when the gas cooktop is set to a low power level.
- ▶ If necessary, reduce the power level on the cooktop extractor when you turn on the gas cooktop.
- ▶ Do not use the gas cooktop without cookware. The gas flame is protected from the airflow of the cooktop extractor by the geometry of the pan supports and the cookware.
- ▶ If necessary, reduce the power level on the cooktop extractor to improve heat input or distribution.

INFO Flames can set fire to or damage the grease filter in the cooktop extractor and the air-channelling components. Never flambé food when using a cooktop extractor.

INFO The performance characteristics of the gas cooktop (e.g. heating times, efficiency, etc.) are affected by the cooktop extractor. The cooktop extractor also affects the heat input and distribution.

INFO In recirculation mode the recirculated air affects the gas cooktop.
If the gas flame goes out, is excessively affected by the extractor and/or the flame is not as it should be (e.g. soot production, flame blowback, etc.), the return flow aperture must be enlarged.

6.2 Touch control

INFO The system recognises 3 different touch commands. It differentiates between brief touches (tap), longer contact (long press) and vertical swiping movements with your finger (swipe).

Touch command	applicable to	Time (contact)
Tap (touch briefly)	Buttons + slider	0.065 – 0.95 s
Long press (hold down)	Buttons + slider	1 – 8 s
Swipe (vertical movement)	Slider	0.15 – 8 s

Tab. 6.1 Touch control

If touch commands do not work or are not working properly, the following should be taken into account:

- ▶ Tap the touch zones with only one finger.
- ▶ Ensure that no other parts of your hand are touching the operating panel when using the controls.
- ▶ Keep the contact area as small as possible when using the touch zones.
- ▶ Make sure that your fingers are clean and dry before using the touch controls.

6.3 Operating the system

6.3.1 Operating principle

Operation	Command
Tap a function	Activating a function
Long press on a function	Deactivating a function*
Swipe (slider)	Setting a value (e.g. power level)

Tab. 6.2 Operating principle

6.3.2 Switching on

- ▶ Long press on the power button  until acoustic signal is heard
- The icon lights up and the switching-on animation is shown in the slider.
- Once the system has started successfully, the standard display appears in the operating panel.

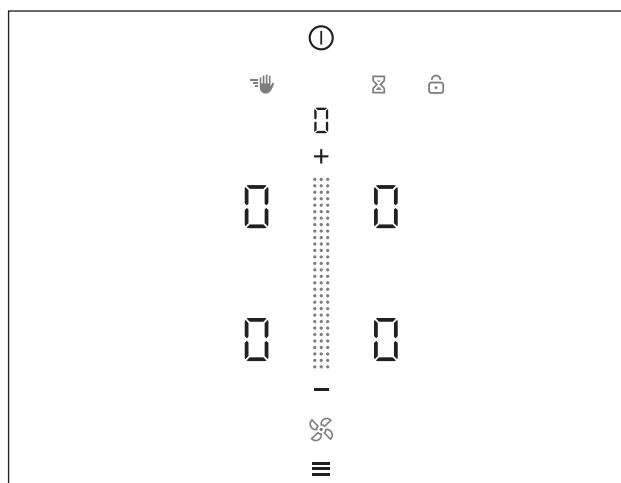



Fig. 6.1 Standard display after switching on

INFO The menu button does not appear after switching on if there is still residual heat in one of the cooking zones.

INFO When the childproofing feature is active, the lock button  lights up after system start. The standard display is only shown when it has been deactivated (also see Childproofing feature).

INFO If *CONF* appears in the display after switching on the system, the basic configuration is still incomplete and must be carried out (see Initial operation chapter).

6.3.3 Switching off

- ▶ Long press on the power button  until acoustic signal is heard
- The switching off animation appears and the display goes out.

The cooktop extractor was switched on:

- The fan symbol flashes and the automatic after-run function is started.
- As soon as the after-run period is over, the switching off animation appears and the display goes out.

The cooktop was switched on:

- In the case of previously active and still hot cooking zones, the residual heat symbol  lights up in signal red and *H* is displayed.
- The display goes out when no more residual heat is present.

INFO The system can be switched off at any time: Long press on the power button

6.3.4 Control lock

Activating the control lock

- ▶ Long press on the lock button 
- The operating panel display is dimmed.
- The lock button lights up.
- All functions except for the power button and lock button are locked.

INFO If the system is switched off when the control lock is active, the control lock will no longer be active next time the system is switched on.

Deactivating the control lock

- ▶ Long press on the lock button  (3 sec.)
- The operating panel display lights up and the operating panel is active again.
- The lock button is dimmed.

6.3.5 Cleaning lock (wipe function)

Activating the cleaning lock

- ▶ Tap the cleaning button 
- The operating panel display is dimmed.
- The cleaning button lights up.
- The operating panel is locked.
- All settings stay the same.
- The countdown starts in the multi-function display.

Time lapsed

- After the end of the time set, the operating panel is automatically unlocked.

INFO If the system detects that the operating panel has been covered for a prolonged period (> 8 sec.) when the cleaning lock is active, after deactivating the cleaning lock all active cooking zones are automatically paused.

6.3.6 Childproofing feature

The lock symbol  lights up in the operating panel display.

Permanently activating the childproofing feature

see the Menu chapter, menu item 2: Childproofing feature

Deactivating the childproofing feature for a cooking session

- ▶ Long press on the lock button  (3 sec.)
- The operating panel display lights up and the operating panel is active again.
- The lock button is dimmed.

6.3.7 Short-time timer (egg timer)

Activating the egg timer

- ▶ Tap the egg timer button 
- The time appears in the 7-segment display above the sliders in hours, minutes and seconds (0:00:00).
- The system changes to colour mode “beige”.
- The cooking zones in the display are dimmed.

Setting the time

See 6.5.9 Cooking zone timer

Start egg timer

- ▶ Tap the start button 
- An acoustic signal can be heard and the set value is confirmed.
- The set time starts to count down.
- The operating panel display changes to the standard display.
- The remaining time is shown by the system exact to the second.
- 10 seconds before the time runs out, the remaining time and egg timer button start to flash.

Time lapsed

- When the set time has lapsed an acoustic signal is heard (max. 60 seconds).
- The time display and egg timer button flash (max. 60 seconds).
- The remaining time is counted down for another 60 seconds maximum (-0:00:01...)

INFO You can stop the acoustic signal and flashing display by tapping the egg timer button.

Deactivating the egg timer early

- ▶ Long press on the egg timer button 
- The egg timer function is ended.
- The operating panel display changes to the standard display.





6.4 Operating the cooktop extractor

INFO To be able to operate the cooktop extractor, fan operation must be active in the operating panel (colour mode “blue”).

The slider and the fan symbol light up blue in the standard display.

6.4.1 Setting the fan power level

The fan power levels can be adjusted in different ways:

- ▶ tap on  or 
- ▶ adjustment using the slider 
- ▶ by tapping a certain position on the slider
- ▶ long press on  or  (adjustment in twos)

Increasing the power level

- ▶ Swipe upwards to the required power level
- or
- ▶ tap **+** until the required power level is reached
- or
- ▶ tap a higher position on the slider
- or
- ▶ long press on **+** (power level is increased in twos: 0, 2, 4...)

Reducing the power level

- ▶ Swipe downwards to the required power level
- or
- ▶ tap **-** until the required power level is reached
- or
- ▶ tap a lower position on the slider
- or
- ▶ long press on **-** (power level is decreased in twos: ... 4, 2, 0)

6.4.2 Fan power setting

Activating the power setting

- ▶ Long press on the slider  at position 5
- or
- ▶ Tap on **+** when power level 5 is active
- An animation appears in the slider.
- **P** appears in the display (flashing 3x at first and then continuous).

INFO After 10 minutes, the power setting is automatically switched back to power level 5.

Deactivating the power setting

The fan power setting is deactivated early if another power level is set (see Setting the fan power level).

6.4.3 Automatic extractor function

INFO The automatic extractor function automatically adjusts the extraction performance to the highest power level used on all cooking zones that are currently in use. If the power level of a cooking zone is changed, the extractor power is automatically adjusted.

INFO On induction cooktops there is a 20-second delay in the power level adjustment and on all other cooktops there is a 30-second delay.

INFO The automatic extractor function can be disabled manually at any time.

Permanently activating the automatic extractor function

see the Menu chapter, menu item 3: Automatic extractor control

Activating the automatic extractor function for a cooking session

- ▶ Tap the fan button .
- The fan symbol lights up blue.
- An animation appears on the slider.
- **P** appears in the 7-segment display.

6.4.4 Switching the fan off

- ▶ Swipe downwards to power level 0.
- or
- ▶ tap **-** until power level 0 is reached.
- or
- ▶ long press on the fan button .
- The automatic after-run function is started.
- As soon as the automatic after-run stops, the cooktop extractor fan is switched off.

6.4.5 Switching off the automatic after-run early

- ▶ Tap the fan button .
- or
- ▶ tap the minus button **-**
- The cooktop extractor after-run function is switched off.

INFO BORA expressly recommends use of the cooktop extractor after-run function.

6.5 Operating the cooktops

INFO To be able to operate the cooktops, cooktop operation must be active in the operating panel (colour mode "red").

INFO If no commands are entered within 3.5 seconds when the cooktop operating panel is active, the system automatically switches back to fan operation (standard display).

6.5.1 Selecting cooking zones

INFO With this system you can operate and control up to 4 cooking zones at the same time.

- ▶ Tap on a cooking zone.
- The system changes to colour mode "red".
- The system switches to the power display.
- The additional cooking zone functions appear.
- Cooking zone operation is activated and you can make settings for the chosen cooking zone.
- ▶ Repeat this process to operate further cooking zones if necessary.

INFO A cooking zone can be switched off early by a further touch command in the cooking zone display. The system then immediately switches to fan operation.

Changing to another cooking zone

INFO When you are in cooktop operating mode (colour mode “red”) and adjust the settings for one cooking zone, you can immediately change over to and operate another cooking zone.

- ▶ Tap another cooking zone within 3.5 seconds.
- The cooking zone lights up in the operating panel display.
- Operation of the second cooking zone is activated.
- The first cooking zone is dimmed in the operating panel display and the previous settings are adopted.

6.5.2 Setting cooking zone power levels

INFO The cooking zone power levels are shown in the corresponding cooking zone display as a 7-segment font.

The cooking zone power levels can be adjusted in different ways:

- ▶ tap on **+** or **-**
- ▶ adjustment using the slider 
- ▶ by tapping a certain position on the slider
- ▶ long press on **+** or **-** (adjustment in threes)

Additional instructions for gas cooktop CKG:

INFO After setting a power level, gas cooktop CKG is automatically ignited and the cooking zone is operated at the set power level.

INFO The ignition process happens several times in succession and generates a typical clicking noise.

INFO If it does not ignite, the procedure can be repeated. When the desired cooking zone is selected and the power level is set, the cooktop is automatically reignited.

Power-level adjustment on cooktops CKFI, CKI, CKIW, CKCH, CKCB and CKG

Increasing the power level

- ▶ Tap the required cooking zone
- ▶ Swipe upwards to the required power level
- or
- ▶ tap **+** until the required power level is reached
- or
- ▶ tap a higher position on the slider
- or
- ▶ long press on **+** (power level is increased in threes: 0, 3, 6...)

Reducing the power level

- ▶ Tap the required cooking zone
- ▶ Swipe downwards to the required power level
- or
- ▶ tap **-** until the required power level is reached
- or
- ▶ tap a lower position on the slider
- or
- ▶ long press on **-** (power level is decreased in threes: ... 6, 3, 0)

INFO If after setting a power level on induction cooktops CKFI, CKI and CKIW no suitable cookware is detected (pan size recognition) within 9 minutes, the corresponding cooking zone will be automatically switched off.

Power-level adjustment on the Tepan stainless steel grill CKT

INFO The Tepan stainless steel grill power levels are shown in the corresponding cooking zone display as a 7-segment font (*1 - 9, P*).
When a cooking zone is selected the temperature is shown in °C in the multi-function display above the slider (temperature indicator).



INFO During the initial heating phase the actual temperature is shown in the multi-function display until the target temperature is reached in the selected cooking zone.

Increasing the temperature



- ▶ Tap the required cooking zone
- ▶ Swipe upwards to the required target temperature
- or
- ▶ tap **+** until the required target temperature is reached
- or
- ▶ tap a higher position on the slider
- or
- ▶ long press on **+** (power level is increased in threes: 0, 3, 6...)

INFO During the heating phase the red hot button  flashes, even if the operating panel display changes to the standard display after 3.5 seconds. When the target temperature is reached, it stops flashing.

Lowering the temperature

- ▶ Tap the required cooking zone
- ▶ Swipe downwards to the required temperature
- or
- ▶ tap  until the required temperature is reached
- or
- ▶ tap a lower position on the slider
- or
- ▶ long press on  (power level is decreased in threes: ... 6, 3, 0)

6.5.3 Switching off the cooking zone

- ▶ Tap the required cooking zone.
- ▶ Swipe right down to the bottom until  appears in the cooking zone display.
- or
- ▶ tap  until  appears in the cooking zone display.
- The residual heat indicator *H* will then appear.



Switching off a cooking zone quickly (Quick Off)

- ▶ Long press on the cooking zone
- A longer acoustic signal provides confirmation.
- The residual heat indicator *H* appears in the cooking zone display if necessary. If there is no residual heat,  is immediately displayed.

6.5.4 Automatic heat up function

INFO The system automatically determines the heating time depending on the power level set.

Activating the automatic heat up function

- ▶ Tap the required cooking zone
- ▶ Setting the power level (= continuous cooking level)
- ▶ Tap the heat-up button 
- The automatic heat up function is activated.
- The automatic heat up function symbol  is shown next to the cooking zone.

INFO If the cooking zone power level is increased while the automatic heat up function is active, the automatic heat up function remains active. The heating time is adjusted accordingly.

INFO If the cooking zone power level is decreased while the automatic heat up function is active, the automatic heat up function is deactivated.

Deactivating the automatic heat up function early

- ▶ Tap the required cooking zone
- ▶ Long press on the heat-up button 
- The automatic heat up function is deactivated.
- The cooking zone changes back to the previously set power level.

Time lapsed

- When the heat up time has lapsed, the previously set continuous cooking level will be activated.
- The heat-up symbol will no longer be displayed.



6.5.5 Power setting

INFO If a cooking zone on one of the cooktops is operated on the power setting, the second cooking zone can be operated on power level 5 at most (exception: on the appliances CKG and CKT the power setting can be activated for both cooking zones).

INFO If a higher level than 5 is set on the second cooking zone when the power setting is activated, the level will automatically be reduced to power level 5.

INFO If a power level higher than 5 is set for the second cooking zone, the active power setting on the first cooking zone will be automatically switched back to the previous level.

Activating the power setting for a cooking zone

- ▶ Tap the required cooking zone
- ▶ Tap on  when power level 9 is active
- or
- ▶ long press on the top end of the slider  (slider position 7-9).
- or
- ▶ swipe to power level 9 and hold the position
- An animation appears in the slider.
- *P* appears in the cooking zone display (flashing 3x at first and then continuous).

INFO After 10 minutes, the power setting is automatically switched back to power level 9. Exception: On gas cooktop CKG the power setting is limited to 20 minutes.

Deactivating the power setting

The power setting is deactivated early if another power level is set (see Setting the power level).



6.5.6 Two-ring connection on cooktops CKCH and CKCB

INFO The two-ring connection can also be activated or deactivated when the heat-up, timer and heat retention functions are active. When the bridging function is activated, the second ring is automatically activated.

Requirements for two-ring connection:

- Cooking session with a power level >0

Activating the second ring

- ▶ Tap the required cooking zone
- ▶ Adjusting the power level
- ▶ Tap the ring button 
- The second ring is activated in the chosen cooking zone.
- The cooking session is continued at the set power level with two active rings.
- The ring symbol  is shown next to the cooking zone indicator.

Deactivating the second ring

- ▶ Tap the required cooking zone
- ▶ Long press on the ring button 
- The second ring is deactivated.
- The cooking session is continued at the set power level with only one active ring.



6.5.7 Bridging function

INFO When the bridging function is active, both cooking zones on the appliance are coupled and operate at the same cooking level.

INFO When the bridging function is active, the power setting P cannot be used on cooktops CKFI, CKI, CKIW, CKCH or KCCB. Use of the power setting P is possible on the Tepan stainless steel grill.



INFO On cooktop KCCB the second ring in the rear cooking zone is automatically activated when the bridging function is activated.

Activating the bridging function

- ▶ Tap on a cooking zone
- ▶ Tap the bridging button 
- The bridging function is now active.
- The bridging symbol  lights up.
- The second cooking zone is activated and operated on the same power level.
- Both cooking zone indicators show the same power level.
- Active additional cooking zone functions are adopted.
- Changes to the power level now apply simultaneously to both cooking zones.

INFO If both cooking zones on a cooktop are already active, the bridging function cannot be activated. The bridging function can be activated if no or one cooking zone is activated.

Deactivating the bridging function

- ▶ Tap a cooking zone with an active bridging function
 - ▶ Long press on the bridging button 
 - The bridging function is deactivated.
 - The selected cooking zone remains active.
- or
- ▶ long press on the cooking zone with active bridging function or long press on the bridging button 
 - The bridging function is deactivated.
 - All cooking zones are deactivated.

INFO If no suitable cookware is detected (pan size recognition) within 10 seconds on induction cooktops with the bridging function active, the bridging function will be disabled and the cooking zones will be deactivated.

Tip for cooktops CKFI, CKI and CKIW: Transferring cooking zone functions



With the aid of the bridging function, on induction cooktops active cooking zone functions (e.g. heat up, timer, warming) can be quickly and easily transferred from one cooking zone to the other. The bridging function is merely a means to an end.

- ▶ Activate the bridging function
- The second cooking zone will be activated and the functions of the active cooking zone are automatically adopted.
- ▶ Move the pot onto the second cooking zone.
- After 10 seconds the first cooking zone and the bridging function will be automatically deactivated by the pan size recognition function.

6.5.8 Setting the warming level

INFO There are three warming levels to choose from (also see Appliance description chapter).



Activating the warming level

- ▶ Tap the required cooking zone
- ▶ Tap the warming button 
- The 1st warming level (-) is displayed.
- The warming symbol  is shown next to the cooking zone.
- In the case of the Tepan stainless steel grill CKT the temperature is also shown in the 7-segment display above the slider.

Increasing or reducing the warming level

- ▶ Tap the required cooking zone
- ▶ Swipe upwards or downwards until the required warming level is reached





Deactivating the warming function

- ▶ Tap the required cooking zone
 - ▶ Long press on the warming button 
- or
- ▶ tap the minus button  until the power level is 0
 - The warming function is deactivated.
 - The residual heat indicator *H* appears in the cooking zone display if necessary.



6.5.9 Cleaning function on the Tepan stainless steel grill CKT

INFO The cleaning function adjusts the Tepan stainless steel grill to a constant temperature of 70 °C, which is perfect for cleaning.

Activating the cleaning function

- ▶ Tap the required cooking zone
 - ▶ Tap the warming button 
 - The 1st warming level (–) is displayed.
 - ▶ Tap the minus button 
- or
- ▶ swipe downwards
- or
- ▶ tap the lowest position on the slider
 - The two cooking zones are automatically linked and the bridging symbol  is displayed.
 -  appears in both cooking zone displays and *CLEAN* appears in the multi-function display.
 - The cleaning function is activated and the Tepan stainless steel grill is heated to 70 °C.
 - During the heating phase, the Hot indicator flashes and an animation appears in the cooking zone displays.
 - As soon as cleaning temperature is reached, the Hot indicator lights up constantly and a different animation appears in the cooking zone displays.

Deactivating the cleaning function

- ▶ Tap the required cooking zone
 - ▶ Long press on the warming button 
- or
- ▶ tap the minus button  until the power level is 0
 - The cleaning function is deactivated.
 - The residual heat indicator *H* appears in the cooking zone display if necessary.



INFO The cleaning function is automatically deactivated after 10 minutes.

6.5.10 Cooking zone timer

INFO The timer function can be used for each cooking zone. Several timers can be activated at the same time (multi-timer).









INFO When the bridging function is active, the timer is adopted for both cooking zones.

Activating the timer

- ▶ Tap on a cooking zone
- The additional cooking zone functions are displayed.
- If the chosen cooking zone is not yet active (= power level ) a power level can now be set.
- ▶ Tap the timer button 
- The time appears in the 7-segment display above the sliders in hours, minutes and seconds ().
- The system changes to colour mode “beige”.

Setting the time



- ▶ Select the desired power level:

Command	Selection in hr/min/sec	
Tap		
Tap		
Command	Increase time	Decrease time
Tap		
Swipe	 upwards	 downwards

Tab. 6.3 Setting the time

- The start button  appears in the operating panel display.

Starting the timer

- ▶ Tap the start button 
- An acoustic signal can be heard and the set value is confirmed.
- The set time starts to count down.
- The timer symbol  is shown next to the cooking zone.
- The operating panel display changes to the standard display after 3.5 seconds.
- 10 seconds before the set time lapses, the system flashes the remaining time. The corresponding cooking zone flashes.

Showing the remaining time

The cooking zone timer is active and the time counts down:

- ▶ Tap the cooking zone
- The remaining time is shown in the operating panel display.



Changing active timers

- ▶ Tap a cooking zone with an active timer
- The system changes to colour mode “red”.
- The remaining time is displayed.
- ▶ Tap the timer button 
- The timer is stopped.
- The remaining time is displayed.
- The system changes to timer-editing mode (colour mode “beige”).
- ▶ Change the set time (see “Setting the time”).
- ▶ Start the timer (see “Starting the timer”).

Switching the timer off early

- ▶ Tap a cooking zone with an active timer
- The remaining time is displayed.
- ▶ Long press on the timer button 
- The timer is switched off.
- The system switches to the standard display.
- The cooking zone remains active on the set power level.

Time lapsed

- An acoustic signal is heard.
- The time display  and the timer symbol  flash briefly.
- After the end of the set time, the cooking zone is automatically switched to power level .
- The residual heat indicator *H* appears in the cooking zone display if necessary.

Multi-timer

INFO Different timers can be set simultaneously for all cooking zones.

If a timer is already active on a cooking zone:

- ▶ Tap on a different cooking zone
- ▶ Activate the timer (see “Activating the timer”)
- ▶ Set the time (see “Setting the time”)
- ▶ Start the timer (see “Starting the timer”)

6.5.11 Pause function

INFO With the pause function you can briefly pause the cooking session. The cooking session can be paused for a maximum of 10 minutes. If the pause function is not deactivated in this time, all cooking zones are switched off.

INFO During the pause, the fan function is not interrupted. Active bridging and egg timer functions remain active. Active timer functions are paused

Activating the pause function

- ▶ Tap the pause button 
- The pause button lights up, all cooking sessions are paused and an acoustic signal is heard.
- The cooking zone indicators are dimmed and flash.
- The pause timer is started (max. 10 minutes).

Deactivating the pause function

- ▶ Long press on the pause button 
- The pause button is dimmed and a longer acoustic signal is heard.
- The cooking zone indicators light up and stop flashing.
- All cooking sessions are resumed at the power levels set prior to the pause.

7 Menu

INFO Below you will find explanations on how to use the menu and a description of all menu items that can be accessed by the end customer.

INFO You will find a separate description of the menu items required for the basic configuration during initial operation in the Initial operation chapter.

INFO Further menu items are available to distribution partners and retailers (see Extended menu chapter).

7.1 Menu overview

INFO The BORA Classic 2.0 system only shows the relevant/applicable menu items according to the appliance configuration.

Menu item/Description/Selection area	Factory setting
Menu:	
1 Volume of the acoustic signals (10 – 100%)	80%
2 Childproofing feature (On/Off)	Off
3 Automatic extractor control (On/Off)	Off
4 Duration of the cleaning lock (5 – 30 s)	15 s
5 Duration of the automatic after-run function (10 – 30 min)	20 min
6 Retrieving the software version	
7 Retrieving the hardware version	
8 System software update	
9 Data export	
A Show the recirculation filter service life (only in recirculation mode)	
B Show filter type, change filter type and reset filter service life (only in recirculation mode, when the filter service life < 20h)	
Basic configuration:	
H Extraction system configuration	
J Select the filter type (only in the case of recirculation)	
L Fan configuration	
Extended menu (access code required):	
B Show filter type, change filter type and reset filter service life (only in the case of recirculation)	
D Demo mode	Off
E Display and button test	
F Reset to factory settings	
Gas configuration menu (only on CKG):	
P GPU (gas classification no.)	0
S GAS (gas characteristic curve)	B
T GAS (turn off gas)	

Tab. 7.1 Menu overview

7.2 How to use the menu

Calling up the menu

INFO The menu can only be called up if all cooking zones and the cooktop extractor are inactive. In addition, there must be no residual heat.



INFO The menu button will only be displayed in the operating panel when all functions are inactive and there is no residual heat.

- ▶ Tap the menu button 
- The menu is called up and the first menu item is displayed (colour mode “beige”).

Closing the menu

- ▶ Long press on the menu button 
- The menu is closed and the standard display appears.

Navigating the menu

- ▶ Tap  or  to go to the required menu item.
- If you have chosen a menu item, after 2 seconds the display automatically changes to the set value.

Schematic diagram

INFO As a help setting, the menu shows the number of optional settings (1 - 3) for each menu item.

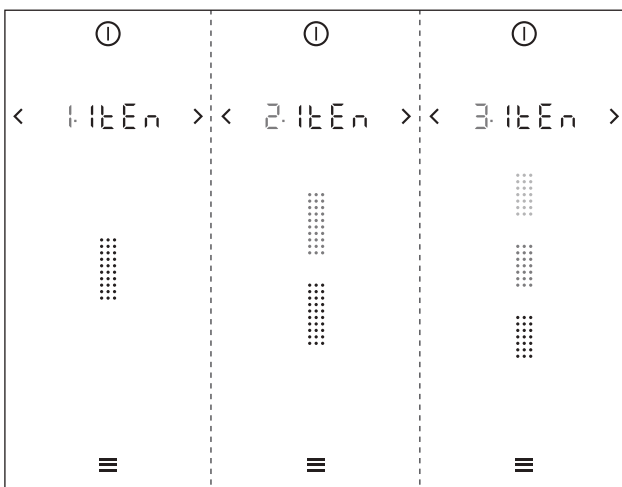





Fig. 7.1 Schematic diagram of the options

Confirming and saving menu settings

- ▶ Tap on  or 
- or
- ▶ long press on the menu button 
- The system automatically adopts and saves set values when you move to another menu item or exit the menu.

7.3 Standard menu items

7.3.1 Menu item 1: Volume of the acoustic signals

INFO The current set volume is shown in the 7-segment display above the slider when the menu item is called up.

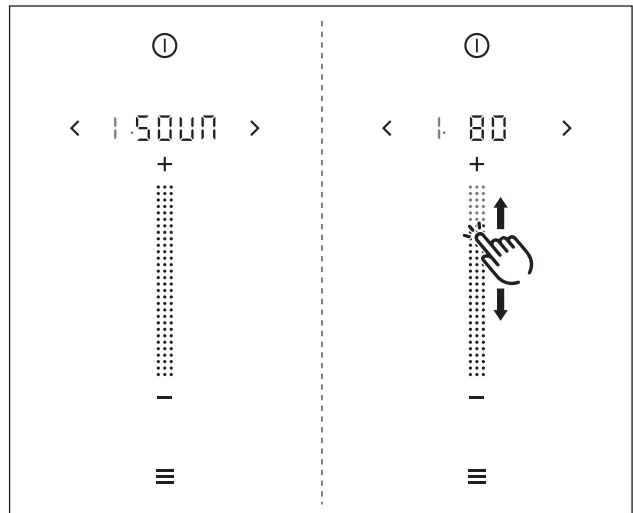





Fig. 7.2 Menu item 1: Volume of the acoustic signals

Setting the acoustic signal volume:

- ▶ Swipe  upwards or downwards until the required volume is reached
- or
- ▶ tap  or  until the required volume is reached
- ▶ Confirm and save the setting.

7.3.2 Menu item 2: Childproofing feature

INFO With menu item 2 the childproofing feature can be permanently switched on or off. The setting continues to apply next time the system is started up.

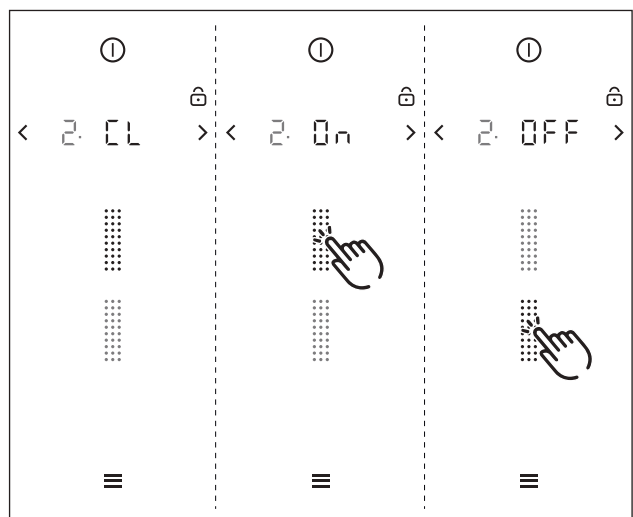





Fig. 7.3 Menu item 2: Childproofing feature

Permanently activating the childproofing feature

- ▶ Tap the top slider segment 
- The display shows .
- ▶ Confirm and save the setting.
- The childproofing feature is permanently activated.

Permanently deactivating the childproofing feature

- ▶ Tap the bottom slider segment 
- The display shows *OFF*.
- ▶ Confirm and save the setting.
- The childproofing feature is permanently deactivated.

7.3.3 Menu item 3: Automatic extractor control

INFO With menu item 3 the automatic extractor function can be permanently switched on or off. The setting is immediately adopted.

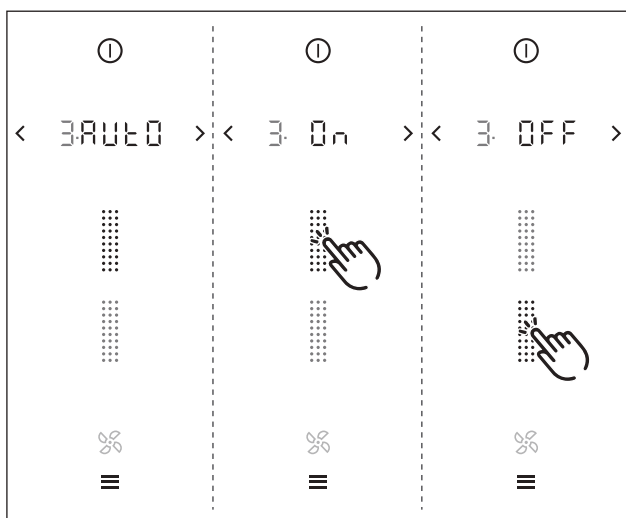



Fig. 7.4 Menu item 3: Automatic extractor function

Permanently activating the automatic extractor function

- ▶ Tap the top slider segment 
- The display shows *On*.
- ▶ Confirm and save the setting.
- The automatic extractor function is permanently activated.

Permanently deactivating the automatic extractor function

- ▶ Tap the bottom slider segment 
- The display shows *OFF*.
- ▶ Confirm and save the setting.
- The automatic extractor function is permanently deactivated.

7.3.4 Menu item 4: Duration of the cleaning lock (wipe function)

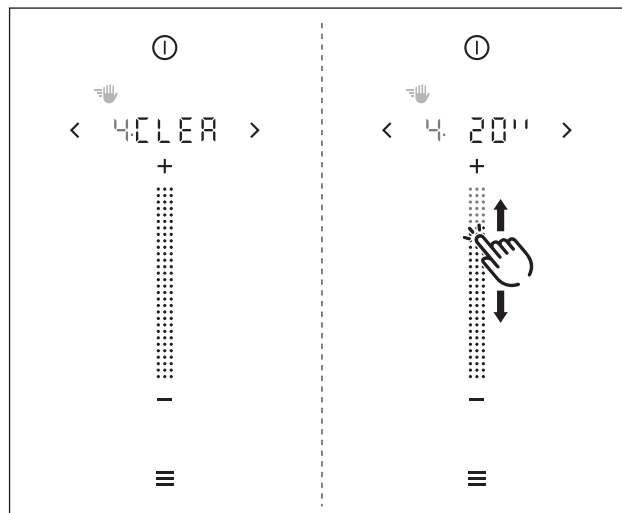

Fig. 7.5 Menu item 4: Duration of the cleaning lock

Setting the duration of the cleaning lock

- ▶ Swipe to obtain the required duration (5–30 s)
- or
- ▶ tap **+** or **-** until the required duration is reached
- ▶ Confirm and save the setting.

7.3.5 Menu item 5: Duration of the automatic after-run function

INFO Use of the cooktop extractor after-run function makes sense and BORA expressly recommends it.

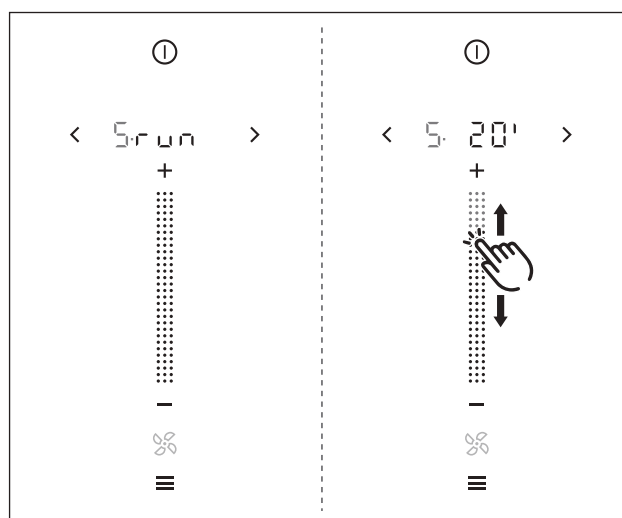





Fig. 7.6 Menu item 4: Duration of the cleaning lock

Setting the fan after-run time

- ▶ Swipe  to obtain the required duration (10–30 min)

or

- ▶ tap  or  until the required duration is reached
- ▶ Confirm and save the setting.

7.3.6 Menu item 6: Retrieving the software version

INFO The system software version may be needed by the BORA Service Team during an error search.

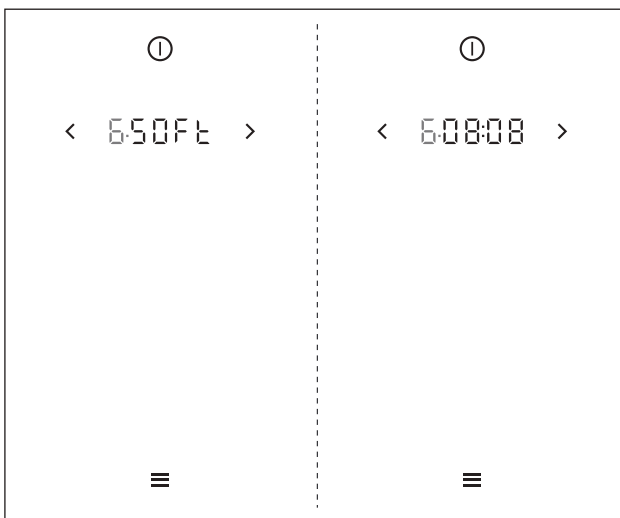

Fig. 7.7 Menu item 6: Retrieving the software version

- The current system software version is displayed after 2 seconds.

7.3.7 Menu item 7: Retrieving the hardware version

INFO The appliance hardware version may be needed by the BORA Service Team during an error search.

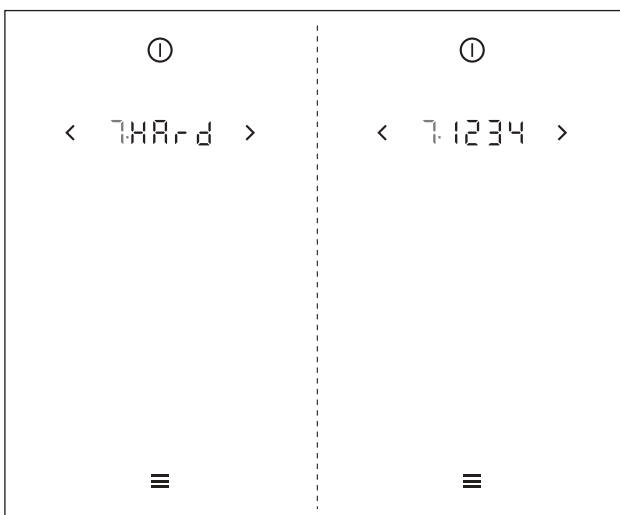

Fig. 7.8 Menu item 7: Retrieving the hardware version

- The current hardware version of the appliances is displayed after 2 seconds.

7.3.8 Menu item 8: System software update

INFO A system software update may be necessary for troubleshooting.

INFO The latest software for the BORA Classic 2.0 system is available on the BORA website free of charge. (www.bora.com – Products – BORA Classic 2.0 – BORA Classic cooktop extractor CKA2 – Documents).

Scan the QR code and you will be redirected to the page with the latest software.



INFO A USB stick with FAT32 formatting is needed to save the update file. This USB stick must be inserted into the USB port on the cooktop extractor.

INFO A valid update file must be stored on the USB stick. When the occasion arises, you can obtain the update file from the BORA Service department.

Starting the software update

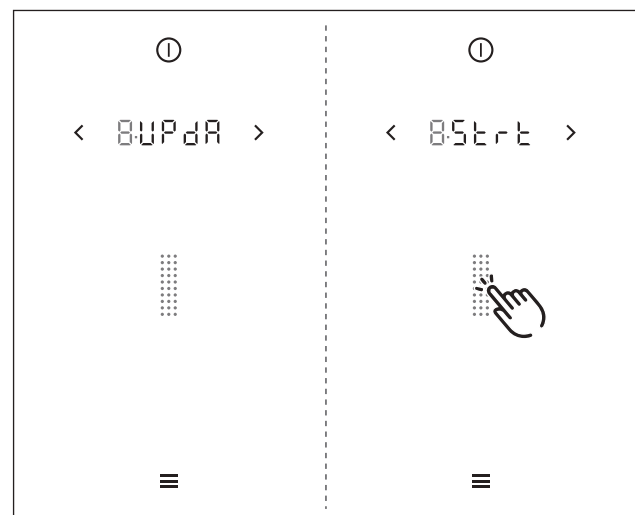





Fig. 7.9 Menu item 8: Starting the software update

- ▶ Insert the USB stick with the update file in the USB port on the cooktop extractor.
- ▶ Tap the slider 
- The software update is started.
- The indicator for the first part of the update process flashes.

Update process

The update process has three stages. These three stages are shown in the display by beige slider segments (  ). The currently active stage will flash. If a stage in the process has been completed successfully, the corresponding segment will stop flashing and will light up green. The next stage in the process is started.

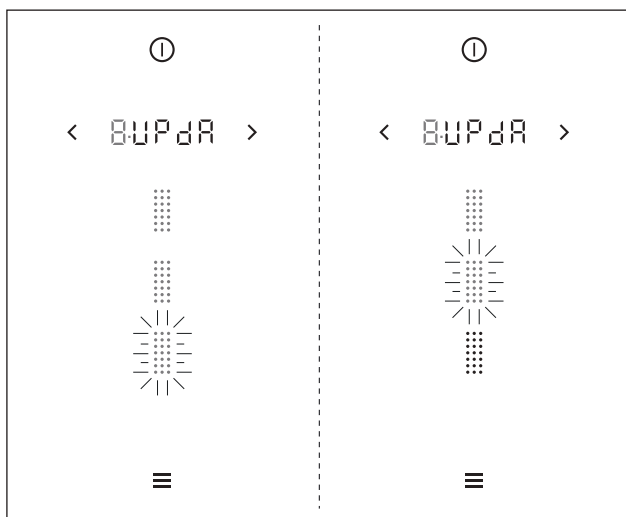

Fig. 7.10 Menu item 8: Software update process stages

INFO If the update is completed without errors, all three segments will light up green. The system will then be restarted automatically.

INFO The update has been completed successfully if *! SoFE* is shown in the display when the system is restarted.

INFO If an error occurs during an update stage (the corresponding slider segment lights up red), the complete update process is terminated. An error message appears in the operating panel display (e.g. *E 123*; see Troubleshooting chapter).

7.3.9 Menu item 9: Data export

INFO Data export makes error analysis easier.

INFO A USB stick with FAT32 formatting is needed to save the exported data. This USB stick must be inserted into the USB port on the cooktop extractor.

INFO Data is exported in three stages. The stages of the three processes can be seen in the operating panel display as in the “software update” (see Menu item 8).

Start data export

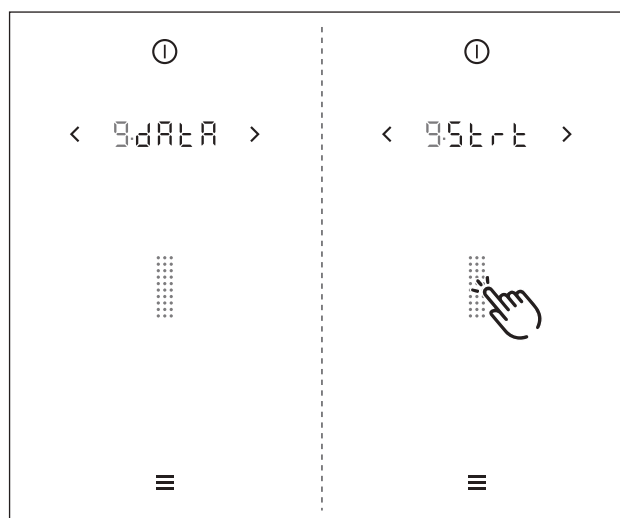



Fig. 7.11 Menu item 9: Data export

- ▶ Insert the formatted USB stick into the USB port.
- ▶ Tap the slider .
- Data export is initiated.
- The indicator for the first part of the export process flashes.

INFO If the data export is completed without errors, all three segments will light up green.

INFO If an error occurs during data export (the corresponding slider segment lights up red), the data export is terminated. An error message appears in the operating panel display (e.g. *E 123*; see Troubleshooting chapter).

7.3.10 Menu item A: Show the recirculation filter service life (only in recirculation mode)

INFO The maximum service life of the recirculation filter is defined by the filter type configured in the system.

INFO The remaining filter service life is shown to the exact hour in the multi-function display and also on the slider by the colours green, orange and red.

Indicator:

Remaining service life	Colour	Meaning
> 20 h	Green	filter change not yet required
5 – 20 h	Orange	filter change due soon
< 5 h	Red	Filter must be changed (very soon)

Tab. 7.2 Recirculation filter service life indicator

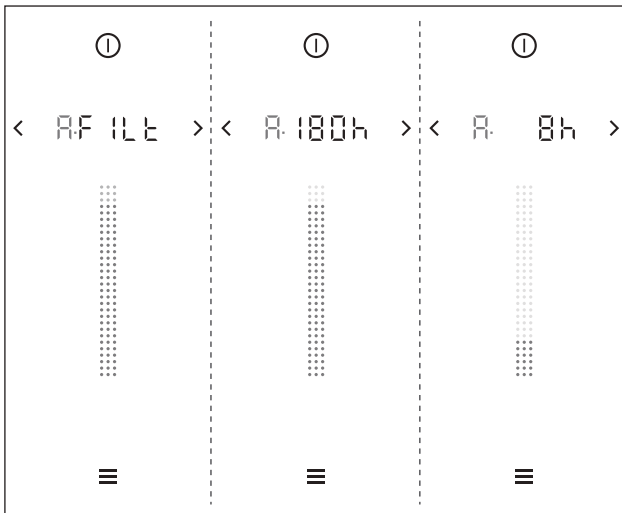

Fig. 7.12 Menu item A: Show the recirculation filter service life

INFO If the service life of the activated charcoal filter is exceeded, the correct functioning of the system may be affected. It is still possible to use the cooktop extractor, however, the warranty and guarantee claims shall then be invalid.

7.3.11 Menu item B: Show filter type, change filter type and reset filter service life (only in recirculation mode)

INFO Menu item B is only displayed in the menu when the remaining filter service life < 20h. Menu item B is always displayed in the extended menu (access code required).

INFO If menu item B is called up, the last filter type used will be displayed automatically.

INFO If a filter has reached the end of its service life, the filter service indicator is shown in the menu and the filter must be changed. After changing the filter, the filter service life must be reset.

Selecting the filter type and resetting the filter service life:

Top slider segment:

■ Filter type 1 (F I)= BORA air cleaning box ULB1/ULBF (or other manufacturer's with 300 hr service life)

Bottom slider segment:

■ Filter type 3 (F 3)= BORA air cleaning box ULB3 (or other manufacturer's with 400 hr service life)

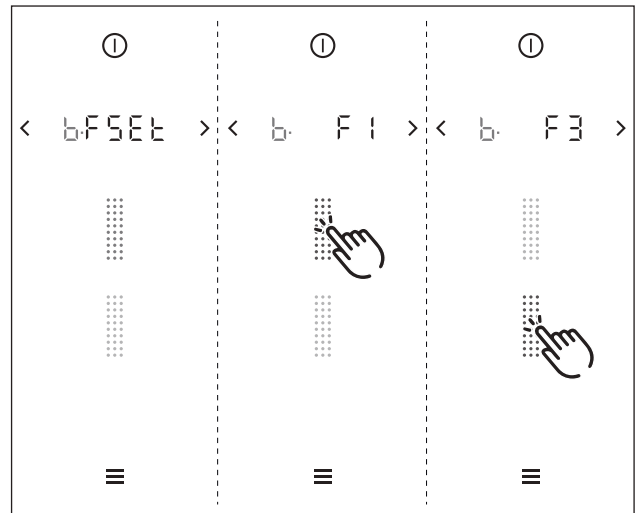



Fig. 7.13 Menu item B: Show filter type, change filter type and reset filter service life

▶ Tap a slider segment 

■ The filter type is selected and the filter service life reset.

■ The new remaining service life of the recirculation filter is then shown.

8 Extended menu

(Access code required)

INFO BORA distribution partners and retailers have the option of extending the menu and unlocking further menu items. This extended menu can only be called up with the corresponding access rights by entering an access code.

INFO The access code to the extended menu is available in the BORA PartnerNet for those with the corresponding access rights. The BORA PartnerNet is the service platform for trade and distribution partners.



Scan the QR code or follow this link:

<https://partner.bora.com/en/classic-2>

8.1 Calling up the extended menu

INFO The extended menu can only be called up if all cooking zones and the cooktop extractor are inactive. In addition, there must be no residual heat.

INFO The menu button will only be displayed in the operating panel when all functions are inactive and there is no residual heat.

- ▶ Long press on the menu button 
- The display appears for entering the four-digit access code.

Entering the access code

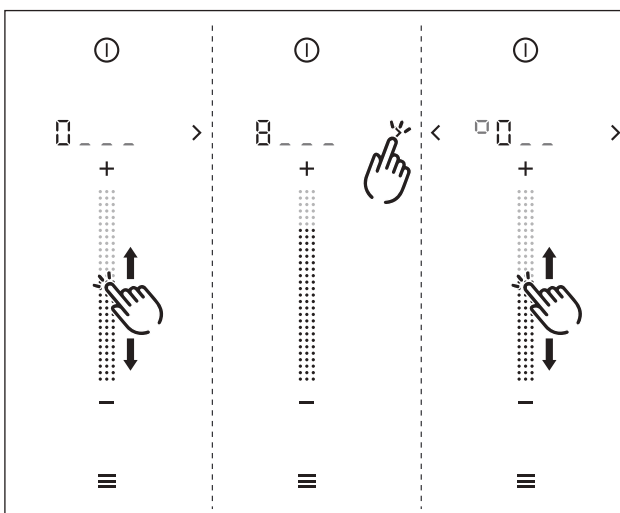





Fig. 8.1 Entering the access code

- ▶ Use the slider to enter the first number in the access code.
- ▶ Tap  or  to change to the next or previous number
- ▶ Repeat this process until you have entered all 4 digits of the access code.

Cancelling access code entry

- ▶ Long press on the menu button 
- The code entry process is terminated and the system switches back to the standard display.

Confirmation of the access code

When all 4 digits of the access code have been entered:

- ▶ tap the menu button 
- If the code has been entered correctly the extended menu is unlocked and menu item 1 “Volume of the acoustic signals” is displayed.

INFO If the protected menu area has been unlocked, all standard menu items will still be shown first (see Menu chapter). All extended menu items follow.

INFO If the access code cannot be confirmed (the system does not react), the code has been entered incorrectly and the extended menu cannot be unlocked.

Exiting the extended menu

- ▶ Long press on the menu button 
- The menu is closed and the standard display appears.

INFO Upon exiting the extended menu, the menu is locked again. To call up the extended menu again, the access code must be entered.

INFO If the system is restarted from the extended menu (manually or automatically), the extended menu is locked again after the system has restarted.

8.2 Extended menu items

INFO You can find exact instructions on using the menu in the Menu chapter.

8.2.1 Menu item B: Show filter type, change filter type and reset filter service life (only in recirculation mode)

INFO If menu item B is called up, the last filter type used will be displayed automatically.

INFO If a filter has reached the end of its service life, the filter service indicator is shown in the menu and the filter must be changed. After changing the filter, the filter service life must be reset.

Selecting the filter type and resetting the filter service life:

Top slider segment:

■ Filter type 1 (F1) = BORA air cleaning box ULB1/ULBF (or other manufacturer's with 300 hr service life)

Bottom slider segment:

■ Filter type 3 (F3) = BORA air cleaning box ULB3 (or other manufacturer's with 400 hr service life)

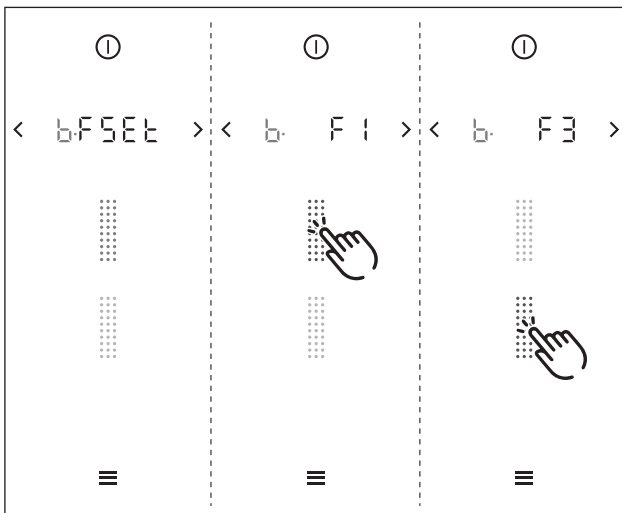



Fig. 8.2 Menu item B: Show filter type, change filter type and reset filter service life

- ▶ Tap a slider segment 
- The filter type is selected and the filter service life reset.
- The new remaining service life of the recirculation filter is then shown.

8.2.2 Menu item D: Demo mode

The system can be set to demo mode, which includes all operating functions, but the heating function of the cooktops is deactivated.

INFO The demo mode always simulates the following cooktop combination:
left = CKFI
right = CKCH

INFO Cooktop extractor CKA2 is operated with a full scope of functions exactly as it has been configured.

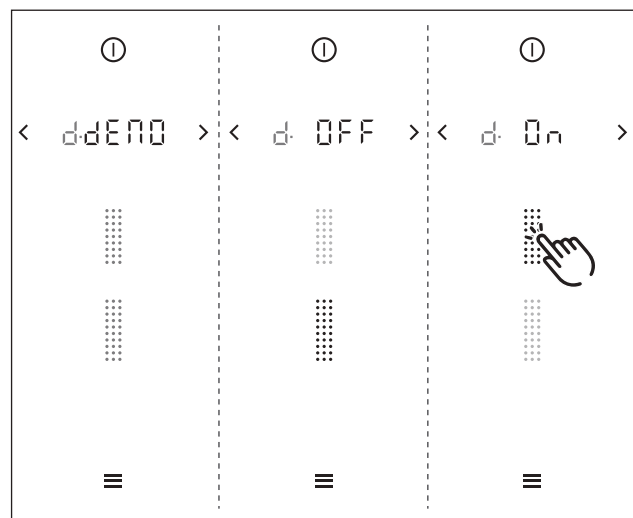



Fig. 8.3 Menu item D: Activate the demo mode

Activating the demo mode:

- ▶ tap the top slider segment 
- The top slider segment starts flashing and demo mode activation starts (this can take up to 30 seconds).
- The system is then automatically restarted and the demo mode is activated.

INFO After switching on in demo mode, *dENO* is shown in the multi-function display for 4 seconds.

Deactivating the demo mode:

- ▶ Tap the bottom slider segment 
- The bottom slider segment starts flashing and demo mode deactivation starts (this can take up to 30 seconds).
- The system is then automatically restarted and the demo mode is deactivated.

INFO All settings made in the demo mode are deleted when the demo mode is deactivated. The system and all settings are reset to the basic factory settings. After that it is necessary to go through the initial operation process (see Initial operation chapter).

8.2.3 Menu item E: Display and button test

INFO The display and button test checks that all LEDs in the operating panel are working.

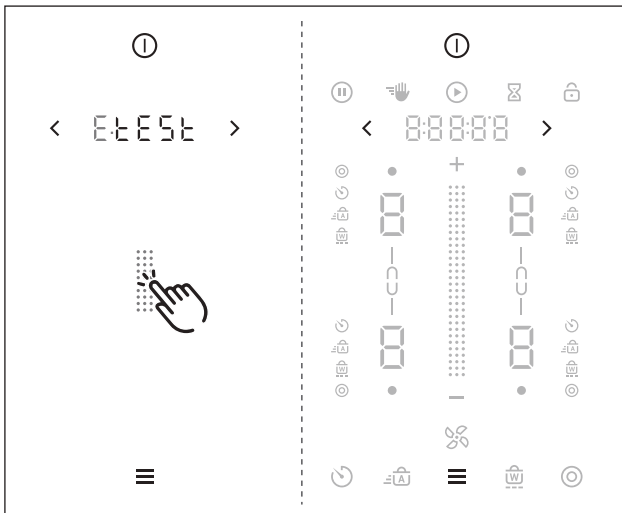











Fig. 8.4 Menu item E: Display and button test

Activating the display and button test:

- ▶ Tap the slider zone 
- All touch control and display areas of the operating panel are shown at 50% brightness.
- The power button, the navigation arrows and the menu button are not included in the test (100% brightness).

Test options:

- ▶ Tap a button
- The symbol flashes at 100% brightness.
- ▶ Swipe 
- The slider flashes at 100% brightness. The cooking zone indicators and the multi-function display change their values depending on the slider position.
- ▶ Tap on a cooking zone
- All indicators in the cooking zone flash at 100% brightness.
- ▶ Tap an additional cooking function
- All additional cooking function symbols in the corresponding cooking zone flash at 100% brightness.
- ▶ Tap  / 
- The corresponding button flashes red, then green, then blue, once for each colour.
- ▶ Tap  /  /  /  / 
- The corresponding button flashes 3x.

8.2.4 Menu point F: Reset to factory settings

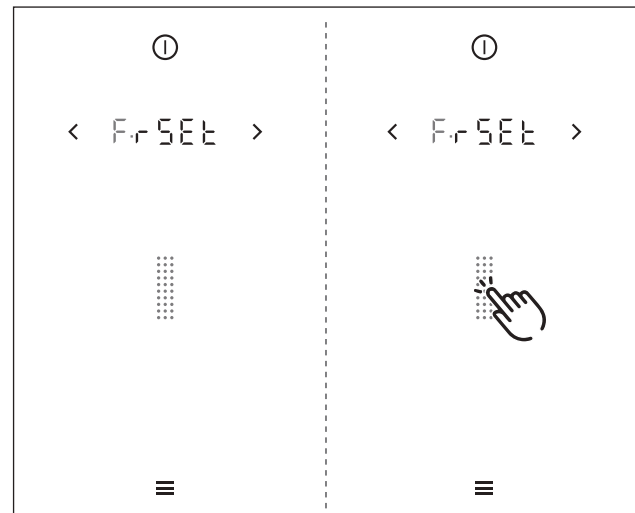



Fig. 8.5 Menu item D: Activate the demo mode

Resetting to factory settings:

- ▶ Tap the slider zone 
- The system and all settings are reset to the basic factory settings.

8.3 Gas configuration menu

INFO The burner nozzles, gas type, gas pressure and gas characteristic curve may only be changed by a certified engineer or BORA service technician. He/she also assumes responsibility for the proper gas installation and commissioning.

INFO Correct settings are important for the safe, problem-free operation of the gas cooktop.

INFO You can find exact instructions on using the menu in the Menu chapter.

8.3.1 Menu item P: GPU

INFO Under menu item P (GPU) the minimum power of each burner and gas type/pressure is regulated.

Setting	Gas type	Gas pressure (mbar)	Ø SR burner/ normal burner	Ø R burner/ high-power burner
0	G20	20	104	125
	G25	20	110	131
4	G30	29	69	85
	G30/31	37	69	85
5	G30/31	50	62	78
10	G20	13	115	149
11	G25	25	104	131
	G25.3	25	104	131
12	G20	25	100	119

Tab. 8.1 Setting the gas type and gas pressure

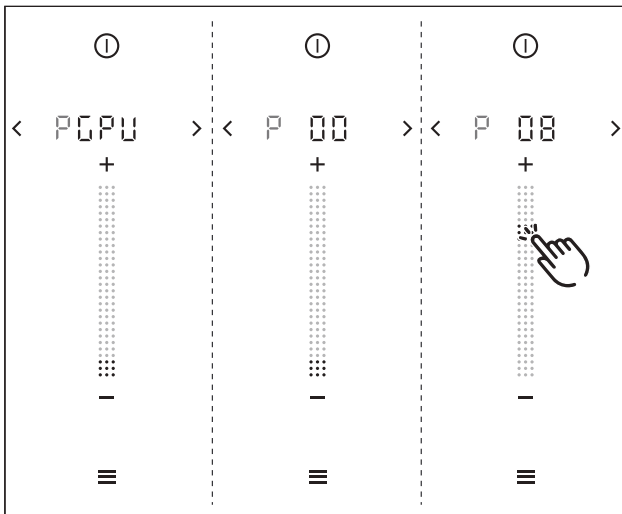



Fig. 8.6 Display menu item P: GPU

► Select the correct setting. (Tap the corresponding slider segment  or setting via **+** or **-**)

8.3.2 Menu item S: GAsT

INFO Under menu item S (GAsT) you can select the characteristic curves for the gas burners.

INFO In the case of liquid gas (G30/31) only characteristic curves B and C can be used.

The characteristic curves regulate the minimum gas burner power values. The minimum power levels are adjusted using the characteristic curves. Depending on the installation situation and the influence of the cooktop extractor, if necessary, the characteristic curve can be changed:

Characteristic curve A:

A enables the fine tuning of the power values, which can only be adjusted in the best-case scenario and only in the case of natural gas (G20, G25, G25.3).

The best-case scenario is when:

- no cooktop extractor is in operation; or
- the cooktop, when using the cooktop extractor in exhaust air mode, is used with sufficient ventilation; or
- the cooktop, when using the cooktop extractor in recirculation mode is used with a sufficient return flow aperture and the cooktop extractor does not have a negative influence on the gas flame.

Characteristic curve B:

B is the factory default characteristic curve with balanced adjustment of the individual power levels.

Characteristic curve C:

C increases the lower power levels and should only be used in the event of a negative influence from the cooktop extractor.

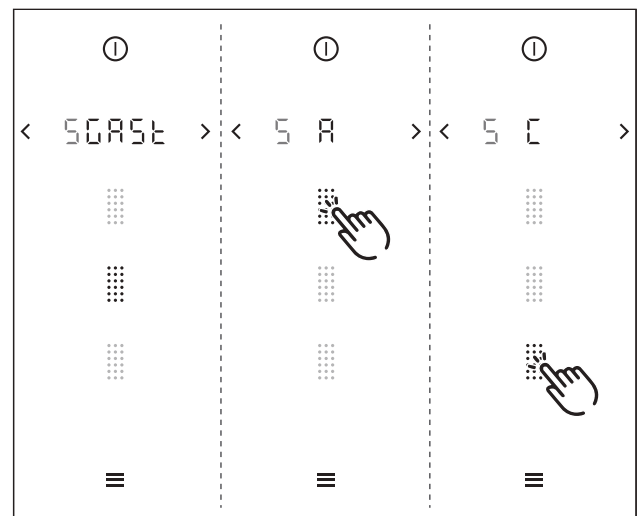



Fig. 8.7 Display menu item S: GAsT

► Select the appropriate characteristic curve (tap the corresponding slider segment .

INFO If the gas flame goes out, is excessively affected by the extractor and/or the flame is not as it should be (e.g. soot production, flame blowback, etc.), the characteristic curve must be increased, as well as the ventilation in exhaust air mode, if necessary, or the return flow aperture in recirculation mode.

8.3.3 Menu item T: GAS

INFO Menu item T (GAS) provides a reset function. This reset function can be used in the case of faults and errors and during initial operation if the gas cooktop does not react (does not ignite).

INFO The set values for the gas type, pressure and characteristic curve remain unchanged and are not affected by the reset.

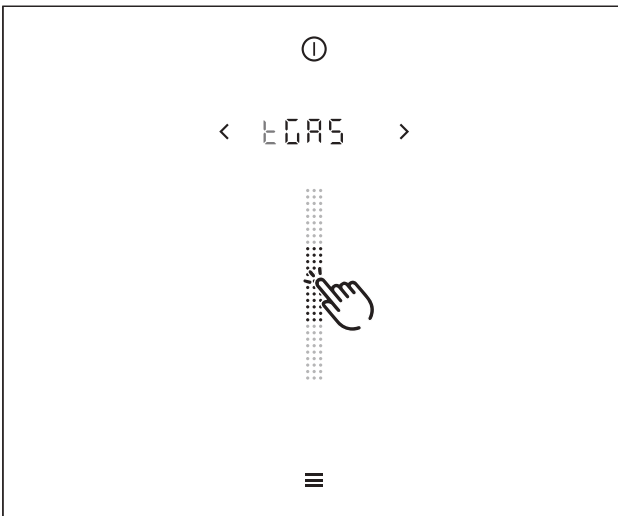



Fig. 8.8 Display menu item T: GAS

- ▶ Reset the system if necessary (tap the slider zone ).

9 Cleaning and Maintenance

- ▶ Observe all safety and warning information (see the Safety chapter).
- ▶ Follow the enclosed manufacturer's information.
- ▶ When conducting scheduled cleaning and maintenance, ensure that the cooktop and cooktop extractor are fully switched off and cooled so as to prevent injury (see the Operation chapter).
- Regular cleaning and maintenance ensures long service life of the product and optimal function.

INFO Clean the stainless steel surfaces in the polishing direction only.

- ▶ Adhere to the following cleaning and maintenance cycles:

Cooktop extractor cleaning cycles

Component	Cleaning cycle
Cooktop extractor interior and surface	After cooking very greasy dishes; at least once a week.
Air inlet nozzle, grease filter unit	After cooking very greasy dishes; at least once a week.
Activated carbon filter (with recirculation only)	Replace if odours have built up or the service life has expired (see Filter service indicator).

Tab. 9.1 Cleaning cycles

Cooktop cleaning cycles

Component	Cleaning cycle
Cooktop	Clean well immediately after soiling, using conventional detergents

Only on gas cooktop CKG:

Pan supports Gas burner parts	Clean well immediately after soiling, using conventional detergents
-------------------------------	---

Tab. 9.2 Cooktop cleaning cycles

9.1 Cleaning agents

INFO Due to the use of aggressive cleaning agents and abrasion caused by the pot bases the surface will become damaged and dark stains will occur.

- ▶ Never use steam cleaners, abrasive sponges, scouring pads or chemically aggressive cleaning agents (e.g. oven cleaner spray).
- ▶ Make sure that the cleaning agent does not contain any sand, soda, acids, lyes or chloride.

Glass ceramic cooktops:

To clean the cooktops, you need a special glass ceramic scraper and suitable cleaning agents.

INFO Do not use the glass ceramic scraper in the curved cooking zone of the wok cooktop.

Tepan stainless steel grill:

To clean the Tepan stainless steel grill you need a special Tepan spatula and suitable cleaning agents.

9.2 Looking after your appliances

- ▶ Never use the appliances as work or storage surfaces.
- ▶ Do not push or pull cookware over the appliance surfaces.
- ▶ Always lift pots and pans.
- ▶ Keep the appliances clean.
- ▶ Remove any kind of dirt immediately.
- ▶ Only use cookware suitable for glass ceramic cooktops (see Appliance description chapter).

9.3 Cleaning cooktop extractor CKA2

Grease particles and limescale residues from cooking vapours can settle on the surface and in the extraction system.

- ▶ Remove the air inlet nozzle and grease filter prior to cleaning.
- ▶ Clean the surfaces using a soft, damp cloth, detergent or a mild window cleaning agent.
- ▶ Soften dried on dirt using a damp cloth (do not scrape it off!).
- ▶ Clean the cooktop extractor components in accordance with the cleaning cycles.

9.3.1 Removing the components

Removing the air inlet nozzle

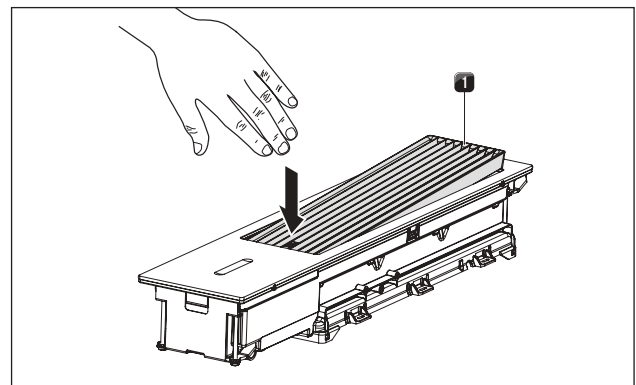

Fig. 9.1 Removing the air inlet nozzle

[1] Air inlet nozzle

- ▶ Tilt the air inlet nozzle [1] from its horizontal position.
- ▶ Remove the air inlet nozzle [1] with your other hand.

Removing the grease filter unit

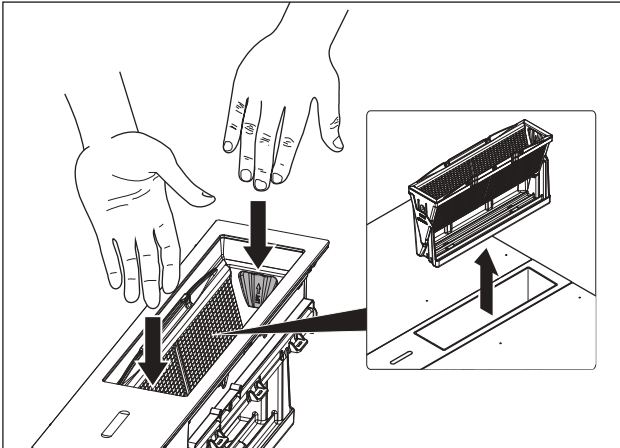

Fig. 9.2 Removing the grease filter unit

- ▶ Remove the grease filter unit.
- ▶ To do this, use the handle inside the grease filter unit.

Disassembling the grease filter unit

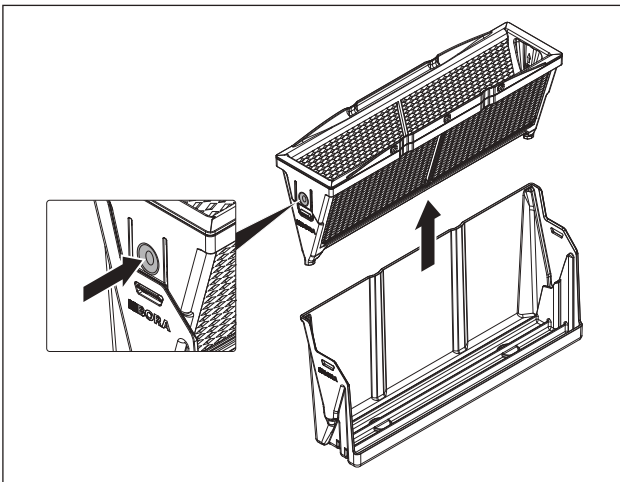

Fig. 9.3 Removing the grease filter

- ▶ Remove the grease filter from the tray.
- ▶ To do this, push in the 2 locking tabs on each end of the filter.

9.3.2 Cleaning the components

The air inlet nozzle, grease filter and tray can be cleaned manually or in a dishwasher.

- ▶ Disassemble the grease filter unit prior to cleaning.

Manual cleaning

- ▶ Use a cleaner and degreaser in one.
- ▶ Rinse the components with hot water.
- ▶ Clean the components with a soft brush.
- ▶ Rinse the components well after cleaning.

Cleaning in the dishwasher

- ▶ Place the components face down in the dishwasher.
- No water should be able to gather in the grease filter components.
- ▶ Wash on a programme with a maximum temperature of 65 °C.
- If it is no longer possible to clean the grease filter completely, it must be replaced.

9.3.3 Fitting the components

Assembling the grease filter unit

INFO It is not necessary to apply pressure when assembling the components. The grease filter unit is designed so that the individual parts can be assembled without force and with no room for error.

- ▶ Carefully insert the grease filter into the tray.
- ▶ Ensure that the lock clicks into place.
- ▶ Do not force the grease filter into the tray.
- If you notice any resistance whilst inserting the grease filter, you just need to turn it around.

Fitting the grease filter unit

INFO The grease filter unit can only be fully inserted without resistance if it is facing the right way. If the instructions are followed correctly, it is impossible to fit it incorrectly.

- ▶ Carefully insert the grease filter unit into the cooktop extractor.
- ▶ Do not force the grease filter unit into the cooktop extractor.
- If you notice any resistance whilst inserting the grease filter unit, you just need to turn it around.

Fitting the air inlet nozzle

- ▶ Insert the air inlet nozzle.
- ▶ Make sure it is positioned correctly.

9.3.4 Replacing the recirculated air filter

In recirculation mode, an additional activated carbon filter is used. The activated carbon filter absorbs cooking odours. The activated carbon filter is installed on the plinth fan or the duct system.

INFO Regularly replace the activated carbon filter. The service life can be found in the operating instructions for the relevant activated carbon filter.

INFO You can obtain activated carbon filters from your specialist supplier or by contacting BORA via the website at <http://www.bora.com>.

- A description of how to replace the activated carbon filter can be found in its operating instructions.
- ▶ Reset the filter service indicator (see the Menu chapter, point 7.3.11).

9.4 Cleaning the cooktops

9.4.1 Cleaning glass ceramic (CKFI, CKI, CKIW, CKCH, CKCB, CKG)

- ▶ Make sure that the cooktop is switched off (see the Operation chapter).
- ▶ In the case of gas cooktop CKG, make sure the gas supply is interrupted and switched off.
- ▶ Wait until all cooking zones are cold.
- ▶ Remove all coarse dirt and food residues from the cooktop using a glass ceramic scraper.
- ▶ Apply the cleaning agent to the cold cooktop.
- ▶ Spread the cleaning agent using kitchen roll or a clean cloth.
- ▶ Wipe the cooktop clean with a damp cloth.
- ▶ Dry the cooktop with a clean cloth.

If the cooktop is hot:

- ▶ Remove stubborn residues of plastic, aluminium foil, sugar or sweet dishes from the hot cooking zone immediately using a glass ceramic scraper to prevent burning.

Heavy soiling

- ▶ Remove heavy soiling and marks (limescale marks, mother-of-pearl-like shiny marks) using cleaning products while the cooktop is still warm.
- ▶ Wipe off food that boils over with a damp cloth.
- ▶ Remove any remaining dirt with the glass ceramic scraper.
- ▶ Always remove any seeds, crumbs or similar that fall onto the cooktop during cooking immediately to prevent the surface getting scratched.

Any changes in colour or glossy spots are not damage to the cooktops. They do not affect the functionality of the cooktop or the stability of the glass ceramic panel.

Changes in the colour of the cooktop are the result of residues which have not been removed and have burnt on.

Glossy spots are the result of wear by the pan base, especially if aluminium-based cookware or unsuitable cleaning agents are used. These are difficult to remove.

INFO In the case of gas cooktop CKG, due to the use of enamelled cast iron parts, slight colour variations and irregularities are common. Furthermore, flash rust can appear at the support points, which can be easily removed with a damp cloth. These spots are normal and are not considered an impairment.

9.4.2 Cleaning Tepan stainless steel grill surfaces (CKT)

INFO Use the scraper only on the grill surface as otherwise other surfaces may be damaged.

INFO Clean the stainless steel surface in the polishing direction only.

INFO Do not apply citric acid to surfaces adjacent to the cooktop and worktop as the acid may damage them.

INFO Do not use stainless steel care products on the stainless steel surfaces or the stainless steel grill surface.

INFO Use the Tepan stainless steel grill cleaning function for cleaning (see Operation chapter).

Light soiling

- ▶ Make sure that the cooktop is switched off (see the Operation chapter).
- ▶ Wait until the stainless steel grill surface has cooled.
- ▶ Remove light soiling with a damp cloth and detergent.
- ▶ To prevent water or limescale stains (yellowish colouring), use a soft cloth to dry off the surfaces that have been cleaned with water.

Normal soiling

- ▶ Ensure that the cleaning function is activated for both grilling zones (see the Operation chapter).
- ▶ Wait until the grilling zone indicators are no longer flashing (= optimum cleaning temperature of 70°C).
- ▶ Use only clean, cold water on the grill surface.
- ▶ Leave the water to work for 15 minutes.
- ▶ Then remove all coarse dirt and food residues using a Tepan spatula.
- ▶ Remove the remaining dirt and water with a clean cloth.
- ▶ Dry the cooktop with a clean cloth.

Heavy soiling

- ▶ Ensure that the cleaning function is activated for both grilling zones (see the Operation chapter).
- ▶ Wait until the grilling zone indicators are no longer flashing (= optimum cleaning temperature of 70°C).
- ▶ Dilute a dessert spoon of citric acid (approx. 10 – 15 ml) in a bowl of warm water (approx. 200 ml).
- ▶ Pour the liquid on the grill surface.
- ▶ Leave the solution to work for approx. 5 – 8 minutes.
- ▶ Loosen burned-on food from the grill surface with a plastic brush.
- ▶ Remove all remaining dirt and water (citric acid solution) with a clean cloth.
- ▶ Use only clean, cold water on the grill surface.

- ▶ Remove the remaining dirt and water with a clean cloth.
- ▶ Dry the cooktop with a clean cloth.

Any changes in colour or small scratches are not damage to the cooktops. They do not affect the functionality of the cooktop or the stability of the stainless steel grill surface.

Changes in the colour of the cooktop are the result of residues which have not been removed and have burnt on.

9.4.3 Cleaning the components on gas cooktop CKG

Cleaning the pan supports

INFO The surface of the pan support will become duller with the passing of time. This is quite normal and does not mean that the material is damaged.

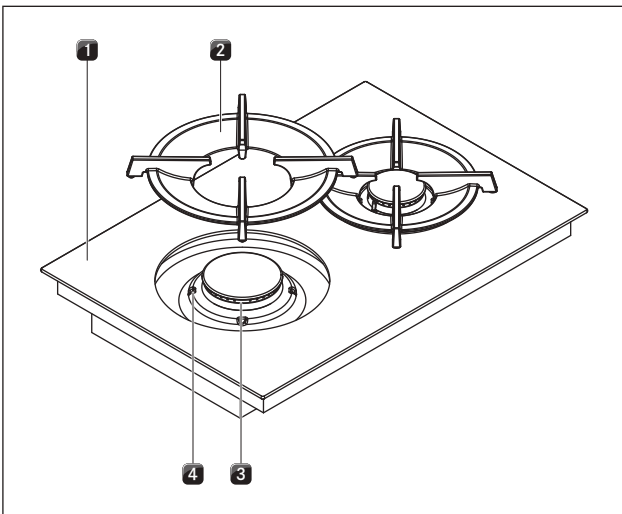

Fig. 9.1 Gas burner structure

- [1] Gas cooktop
- [2] Pan support
- [3] Gas burner
- [4] Positioning aid

- ▶ Remove the pan support [2].
- Pan supports can be cleaned by hand or in the dishwasher.

Manual cleaning

- ▶ Use a cleaner and degreaser in one.
- ▶ Rinse the pan supports with hot water.
- ▶ Clean the pan supports with a soft brush.
- ▶ Rinse the pan supports well after cleaning.
- ▶ Dry the pan supports carefully with a clean cloth.

INFO In the case of particularly stubborn or burned-on dirt, the pan support can be briefly soaked in warm water with washing-up liquid. Any limescale marks can be more easily removed with diluted vinegar.

Cleaning in the dishwasher

- ▶ Rinse the pan supports with a rinsing program at maximum 65 °C.
- ▶ Dry the pan supports carefully with a clean cloth.
- ▶ Place the pan support [2] straight on the gas burner [3] so it fits perfectly, taking into account the positioning aids [4].

Cleaning the gas burner parts

INFO The surface of the burner cap will become duller with the passing of time. This is quite normal and does not mean that the material is damaged.

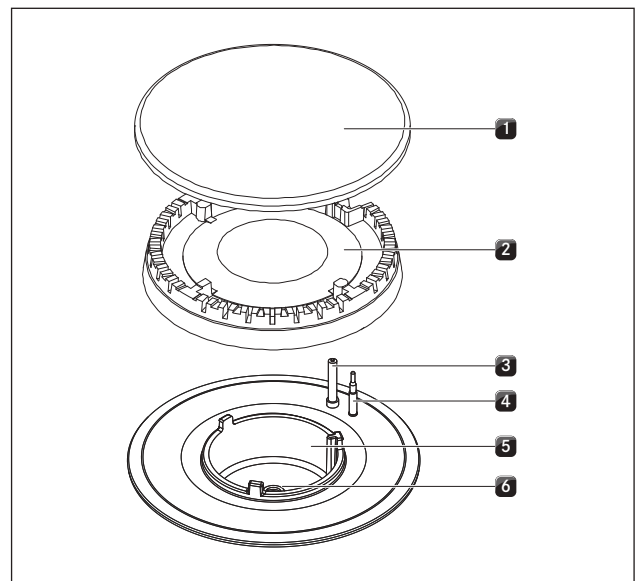

Fig. 9.2 Gas burner structure

- [1] Burner cap
- [2] Burner head
- [3] Electric igniter
- [4] Safety thermocouple
- [5] Burner housing
- [6] Gas burner nozzle





- Do not start cleaning until the gas burner has returned to normal temperature after use.
- The burner parts are not suitable for cleaning in the dishwasher. Only clean the burner part by hand.
- Only clean with normal hot water to rinse and a conventional washing-up liquid, using a soft sponge or a normal dishcloth.
- Never scratch or scrape cooking residues off.
- ▶ Remove the pan support.
- ▶ Remove the burner cap [1] from the burner head [2].

- ▶ Remove the burner head [2] from the gas outlet
- ▶ Clean the parts of the burner.
- ▶ Clean all of the flame outlet openings with a non-metallic brush.
- ▶ Wipe the fixed parts of the burner with a damp cloth.
- ▶ Wipe the igniter electrode [3] and the thermocouple [4] carefully with a well-wrung-out cloth.
- The igniter electrode must not get wet, otherwise the ignition spark will not light.
- ▶ Finally, dry the pan supports carefully with a clean cloth.
- Before reassembling the flame openings, burner heads and burner caps must be completely dry.
- ▶ Put the burner parts back together again.
- ▶ Position the burner head [2] correctly on the gas outlet.
- ▶ Ensure that the safety thermocouple [4] and the electric igniter [3] are positioned in the correct opening.
- ▶ Position the burner cap [1] so that it fits perfectly, sitting straight on the burner head [2].
- If burner parts are not positioned correctly, the electric igniter will not work.
- ▶ Place the pan support straight on the gas burner so it fits perfectly.
- ▶ Put the gas burner into operation (see the Operation chapter).

E = error I = information

10 Troubleshooting

► Observe all safety and warning information (see the Safety chapter).

Operating situation	Cause	Remedy
System		
The system won't switch on (Power button  not visible)	The fuse or automatic circuit breaker of the electrical wiring system in the apartment and/or house is defective	Replace the fuse Switch the automatic circuit breaker back on
	The fuse/automatic circuit breaker trips several times	Contact the BORA Service Team
	The power supply is disconnected	Have a specialist electrician inspect the power supply
	The micro fuse in the control unit's cooling device plug connection is defective	Replace the fuse (type: T 3.15A/250V)
The system switches itself off or switches to standby mode	The operating panel is dirty	Clean the operating panel
	Long press on power button (> 7 s)	Dry the power button immediately after cleaning (< 7 s)
	Error signal during or after cleaning (power button triggered by evaporating cleaning agents)	Use the cleaning lock Clean using a dry cloth
Power button  is flashing	Object on the operating panel	Remove the object from the operating panel
	The operating panel is dirty	Clean the operating panel
Error code <i>iConF</i>	Basic configuration incomplete	Complete basic configuration
Error codes <i>i d ISP, Ed ISP</i>	Object on the operating panel	Remove the object from the operating panel
	The operating panel is dirty	Clean the operating panel
	Permanent activation of a touch zone	Cancel permanent activation
Colour differences between the appliances	Extremely bright lights aimed directly at the appliances	Avoid using spotlights and ensure that lighting is even
Cooktop extractor		
Build-up of odours when new cooktop extractor is in operation	This is normal with brand new appliances	Odours stop forming after a few operating hours
The extraction performance of the cooktop extractor has decreased	The grease filter is extremely dirty	Clean or replace the grease filter
	The activated charcoal filter is extremely dirty (only in recirculation mode)	Replace the activated charcoal filter
	There is an object in the air guiding housing (e.g. cleaning cloth)	Remove the object
	The fan is defective or a duct connection has become loose	Contact the BORA Service Team
No extractor output, red fan symbol  + <i>EFAn</i>	The fan has stopped working or is jammed	Contact the BORA Service Team (the system can be used but without the extraction function)
Reduced extractor output, yellow fan symbol  + <i>iFAn</i>	In a system with 2 fans, 1 fan has stopped working, is jammed or is not connected correctly	Contact the BORA Service Team (the system can be used but with reduced extraction function)
When setting a fan power level it jumps straight back to 0, fan symbol indicator  red	No fan connected	Connect the fan
	The fan is jammed	Contact the BORA Service Team
	There is no power supply to the fan	Check the fan connection
Error codes <i>EOB I, EOPEn</i>	Home In not authorised	Open window and then tap the fan button
Error codes <i>i F ILt, EF ILt</i>	End of recirculation filter service life	Fit a new filter (only in the case of recirculation) and reset the filter service life (see Menu item B).



E = error i = information

Operating situation	Cause	Remedy
Cooktops		
The cooktop is displayed but both cooking zone displays show an error E and an error code is shown in the multi-function display (e.g. E547)	No power supply at the cooktop	Have a specialist electrician inspect the cooktop fuse and power connection respectively
	Faulty generator/electronics	Contact the BORA Service Team
Cooktop not displayed	Cooktop was not recognised	Check the communication cable connection
Error codes EHERL	Overheating	Remove hot objects from the immediately vicinity of the operating panel
		Switch off the system and leave it to cool
		Clean the air vents on the bottom of the appliance (only in the case of Tepan stainless steel grill CKT)
		Contact the BORA Service Team
The cooktops have no output although a power level has been set and dEn0 is displayed	The demo mode is active	Contact your BORA retailer or the BORA Service Team

Faults on gas cooktop CKG

When operating for the first time or after a prolonged period without use or when the gas bottles have been changed:

Burner doesn't ignite	There is air in the gas pipe	Repeat the ignition process, several times if necessary (tap the required cooking zone and set a power level).
Gas cooktop does not react (servomotors do not calibrate and no ignition)	There is a communication error between the control unit and the cooktop (e.g. in the event of a power cut).	Perform a reset (see Gas configuration menu)
The gas burner cannot be ignited electrically.	The fuse or automatic circuit breaker of the apartment and/or house's electrical system is defective or has been triggered.	Change the fuse. Switch the automatic circuit breaker back on. If necessary, contact a specialist electrician.
	The fuse or the automatic circuit breaker trips several times.	Contact the BORA Service Team.
	The power supply is disconnected.	Have a specialist electrician inspect the power supply.
	The gas burners are damp.	Dry the gas burner parts (see the Cleaning chapter).
	The gas burner heads and/or the gas burner cover are not correctly positioned.	Position the gas burner parts correctly (see the Cleaning chapter).
	The electric igniter and/or thermocouple are dirty	Remove the dirt (see the Cleaning chapter)
	Dirt in the gas burner head	Clean the gas burner parts (see the Cleaning chapter).
The cooktop does not ignite automatically.	Try to ignite it again using the touch surface on the control knob.	



E = error I = information

Operating situation	Cause	Remedy
You notice the smell of gas.	A leakage point in the gas supply line	Switch off the gas supply and immediately extinguish all open flames. Contact a gas engineer. Ensure that all connections are tight (see the Gas installation chapter).
No gas is coming out of the gas burners.	The gas supply is closed	Open the gas supply (see the Operation chapter)
	The gas bottle (in the case of liquid gas LPG) is empty.	Exchange the empty gas bottle for a full gas bottle of the correct gas type.
The gas flame goes out after ignition. The gas flame goes out during operation. The gas flame is uneven.	The gas burner parts (burner heads and/or the gas burner cover) are not correctly positioned.	Position the gas burner parts correctly (see the Cleaning chapter).
	Dirt in the gas outlet openings on the gas burner head.	Clean the gas burner parts (see the Cleaning chapter).
all error codes E... (except E055)	Error when the software is running	Wait 5 seconds, then tap the flashing error indicator E (update error)
		Disconnect the device from the mains for at least 1 min. and restart it.
		Contact the BORA Service Team.
Error code E056	Gas supply interrupted and/or no flame detected. The gas bottle is empty.	Wait 5 seconds, then tap the flashing error indicator E (update error)
		Try to ignite it again (the gas pipe needs a certain amount of time to fill after installation).
		Contact the BORA Service Team.

Tab. 10.1 Resolving a fault

- ▶ After troubleshooting try again and check that the problem has been solved.
- ▶ With all faults, try restarting the system.
- ▶ As a last resort, briefly disconnect the power supply.

INFO During or after an interruption to the power supply, the cooktops may still be hot. In the case of cooktops CKCH, CKCB and CKG, after an interruption to the power supply the residual heat is not displayed, even if they were previously in operation and the cooking zones are still hot.

- ▶ Should faults arise frequently, contact the BORA Service Team (see Warranty, service, spare parts and accessories chapter) and specify the error number displayed and the appliance type (see Identification plates chapter).

11 Warranty, technical service, spare parts, accessories

- Observe all safety and warning information (see the Safety chapter).

11.1 BORA manufacturer's warranty

BORA provides its end customers with a 2-year manufacturer's warranty for its products. The end customer is entitled to this warranty in addition to the statutory claims for defects against the sellers of our products.

The manufacturer's warranty applies to all BORA products sold by authorised BORA dealers with the European Union, with the exception of products labelled by BORA as Universal products or accessories.

The manufacturer's warranty starts as soon as the BORA product is handed over to the end customer by an authorised BORA dealer and is valid for 2 years. By registering on www.bora.com/registration the end customer has the possibility of extending the manufacturer's warranty.

The manufacturer's warranty requires expert (in accordance with the valid BORA ventilation handbook and operating instructions at the time of installation) installation of the BORA products by an authorised BORA dealer. During use, the end customer is to adhere to the specifications and instructions in the operating manual. In order to file a warranty claim, the end customer is to notify their dealer or BORA of the fault and must present the receipt. Alternatively, the end customer can provide proof of purchase by registering on www.bora.com. BORA guarantees that all BORA products are free from material and product defects. The defect must exist prior to delivery of the product to the end customer. In the event that a warranty claim is filed, the warranty shall not commence anew.

BORA will correct defects in BORA products at its own discretion by repairing or replacing the product. All costs for the correction of defects under the manufacturer's warranty shall be assumed by BORA.

Expressly not covered by the BORA manufacturer's warranty are:

- BORA products that were not sold by authorised BORA dealers
- Damage caused by non-adherence to the operating instructions (including product care and cleaning) This represents improper use.
- Damage caused by normal use, e.g. traces of usage on the cooktop

- Damage caused by external influences (such as transport damage, ingress of condensation, damage caused by the elements such as a lightning strike)
- Damage caused by repairs or attempts to repair not made by BORA or persons authorised by BORA
- Damage to the glass ceramic
- Voltage fluctuations
- Secondary damage or claims for damages beyond the defect
- Damage to plastic parts

Legal claims, particularly statutory claims for defects or product liability are not limited by the warranty.

If a defect is not covered by the manufacturer's warranty, the end customer can employ the services of the BORA technical service, however, they must cover the costs themselves.

The laws of the Federal Republic of Germany apply to these warranty conditions.

You can contact us by:

- Telephone: +49 800 7890 0987 Monday to Thursday from 08:00-18:00 and Friday from 08:00-17:00
- Email: info@bora.com

11.1.1 Warranty extension

You can extend the guarantee by registering at www.bora.com/registration.

11.2 Service

BORA Service:

see reverse side of operating and assembly instructions



- In the case of faults you cannot fix yourself, contact your BORA specialist supplier or the BORA Service Team.

The BORA Service Team will require the type designation and serial number of your device (FD number).

This information is provided on the nameplate on the inside of the back cover of the operating instructions as well as on the bottom of the device.

11.3 Spare parts

- Only use original spare parts for repairs.
- Repairs may only be carried out by the BORA Service Team.

INFO Spare parts can be obtained from your BORA dealer, the BORA online service website at www.bora.com/service or by calling the service number provided.

11.4 Accessories

Special accessory CKA2:

- BORA Classic air inlet nozzle CKAED
- BORA Classic grease filter unit incl. grease filter tray CKAFFE

Special accessory for recirculation systems:

- BORA air purification box flexible ULBF
- BORA air purification box Ecotube ULB1
- BORA activated charcoal filter set ULBAS for ULB3

Special accessory for glass ceramic cooktops:

- BORA Glass ceramic scraper UGS

Special accessory CKIW:

- BORA induction wok HIW1

Special accessory CKT:

- BORA Pro Tepan spatula PTTS1

Special accessory CKG:

- BORA gas nozzle set natural gas G25/25 mbar PKGDS2525
- BORA gas nozzle set natural gas G20/13 mbar PKGDS2013
- BORA gas nozzle set natural gas G20/20 mbar PKGDS2020
- BORA gas nozzle set natural gas G25/20 mbar PKGDS2520
- BORA gas nozzle set natural gas G20/25 mbar PKGDS2025
- BORA gas nozzle set natural gas G20/10 mbar PKGDS2010 (only for AUS/NZS)
- BORA gas nozzle set liquid gas G30/G31 50 mbar PKGDS3050
- BORA gas nozzle set liquid gas G30/G31 28-30 mbar PKGDS3028
- BORA burner set PKGBS
- BORA pan support small PKGTK
- BORA pan support big PKGTG

12 Notes



13 Identification plates

INFO On this page you can see the exact classification of your installed appliances. Not all of the spaces reserved for stickers need to contain an identification plate.

► Upon completing installation, affix the identification plates included in the scope of delivery in the spaces below.

Identification plate
Cooktop extractor 1
(please apply here)

Identification plate
Left cooktop
(please apply here)

Identification plate
Right cooktop
(please apply here)

Identification plate
Cooktop extractor 2
(please apply here)

Identification plate
Left cooktop
(please apply here)

Identification plate
Right cooktop
(please apply here)

Germany:

BORA Lüftungstechnik GmbH
Rosenheimer Str. 33
83064 Raubling
Germany
Tel. +49 (0) 8035/9840-0
Fax +49 (0) 8035/9840-300
info@bora.com
www.bora.com

Austria:

BORA Vertriebs GmbH & Co KG
Innstraße 1
6342 Niederndorf
Austria
Tel. +43 (0) 5373/62250-0
Fax +43 (0) 5373/62250-90
mail@bora.com
www.bora.com

Europe:

BORA Holding GmbH
Innstraße 1
6342 Niederndorf
Austria
Tel. +43 (0) 5373/62250-0
Fax +43 (0) 5373/62250-90
mail@bora.com
www.bora.com

Australia – New Zealand:

BORA APAC Pty Ltd
100 Victoria Road
Drummoyne NSW 2047
Australia
Tel. +61 2 9719 2350
Fax +61 2 8076 3514
info@boraapac.com.au
www.bora-australia.com.au

