

**Frost-Free Top Mount
Refrigerator / Freezer**

**Réfrigérateur/congélateur sans
givre à compartiments superposés**

**Refrigerador/congelador sin
escarcha, de puertas horizontales**

User Manual
Guide de l'Utilisateur
Manual del Usuario
Model **HT SERIES**

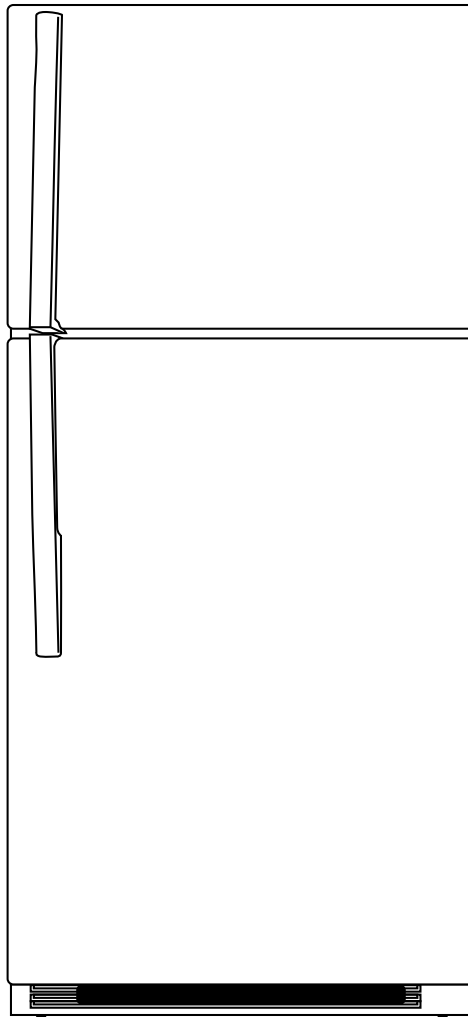

*Design may vary by model number.
La configuration peut varier selon le numéro de modèle.
El diseño puede variar conforme al número de modelo.*

Haier®

SMARTER LIFE

BETTER PLANET

TABLE OF CONTENTS

SAFETY INFORMATION	
Important Safety Instructions	2
SET UP & USE	
Parts & Features	3
Electrical Requirements	4
Installation Guide	5-6
Instructions for Unpacking	5
Installing Your Refrigerator	5
Parts Included	6
Accessories	7
Reversing the Door	7
Door Handle Installation	8
Features and Use	12
CLEANING & CARE	
Proper Care and Maintenance	10-11
TROUBLESHOOTING & WARRANTY	
Normal Operating Sounds	12
Troubleshooting	13-14
Customer Service	14
Limited Warranty	15

PRODUCT REGISTRATION

Thank you for purchasing our Haier product. This easy-to-use manual will guide you in getting the best use of your product. Remember to record the model and serial numbers. They are on a label inside of the Product.

Model number

Serial number

Date of purchase

Staple your receipt to your manual. You will need it to obtain warranty service.

PARTS & FEATURES

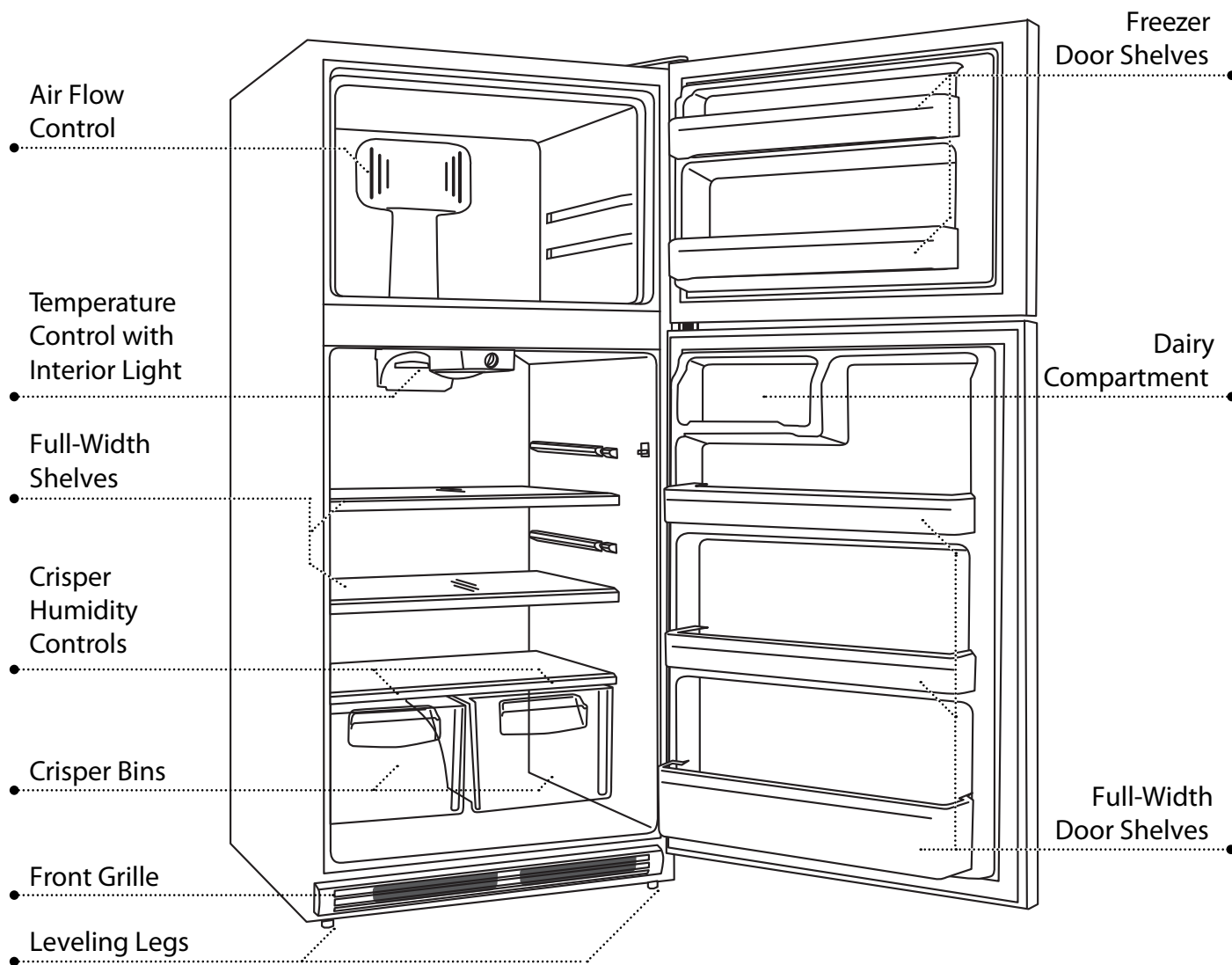

Diagram for instructional purposes only.
Design may vary by model number.

IMPORTANT SAFETY INSTRUCTIONS

WARNING

READ ALL INSTRUCTIONS BEFORE USING THIS APPLIANCE:
WHEN USING THIS APPLIANCE, ALWAYS EXERCISE BASIC SAFETY
PRECAUTIONS, INCLUDING THE FOLLOWING:

NOTE: If the refrigerator has been placed in a horizontal or tilted position for any period of time, wait 4 hours before plugging the unit in.

- 1) Use this appliance only for its intended purpose as described in this use and care guide.
- 2) This refrigerator must be properly installed in accordance with the installation instructions before it is used. See Electrical Requirements in the Set Up & Use section.
- 3) This refrigerator should not be recessed or built-in an enclosed cabinet. It is designed for freestanding installation only.
- 4) Never unplug your refrigerator by pulling on the power cord. Always grasp the plug firmly and pull straight out from the outlet.
- 5) Repair or replace immediately, all electric service cords that have become frayed or otherwise damaged. Do not use a cord that shows cracks or abrasion damage along its length, the plug or the connector end.
- 6) If your old refrigerator is not being used, we recommend that you remove the doors. This will reduce the possibility of danger to children.

WARNING

AFTER YOUR REFRIGERATOR IS IN OPERATION, DO NOT TOUCH THE COLD SURFACES IN THE FREEZER COMPARTMENT, PARTICULARLY WHEN HANDS ARE DAMP OR WET. SKIN MAY ADHERE TO THESE EXTREMELY COLD SURFACES.

- 7) Do not use any electrical device or any sharp instrument in defrosting your refrigerator.
- 8) Unplug your refrigerator before cleaning or before making any repairs.
NOTE: If for any reason this product requires service, we strongly recommend that a certified technician perform service.
- 9) Do not operate your refrigerator in the presence of explosive fumes.

SAVE THESE INSTRUCTIONS

DANGER

RISK OF CHILD ENTRAPMENT. BEFORE YOU THROW AWAY YOUR OLD REFRIGERATOR OR FREEZER, TAKE OFF THE DOORS. LEAVE THE SHELVES IN PLACE SO THAT CHILDREN MAY NOT EASILY CLIMB INSIDE.

ELECTRICAL REQUIREMENTS

GROUNDING INSTRUCTIONS

WARNING

ELECTRICAL REQUIREMENT - SHOCK HAZARD

- Make sure there is a suitable power outlet. 115 Volts, 15 Amps, 3 Prong (Grounded) power outlet with proper grounding to power the refrigerator.
- Avoid the use of three prong adapters or cutting off the third grounding prong in order to accommodate a two prong outlet. This is a dangerous practice since it provides no effective grounding for the refrigerator and may result in shock hazard.

USE OF EXTENSION CORDS

WARNING

USE OF EXTENSION CORD - POTENTIAL SAFETY HAZARD

- Avoid the use of an extension cord because of potential safety hazards under certain conditions. If it is necessary to use an extension cord, use only a 3-wire extension cord that has a 3-blade grounding plug and a 3-slot outlet that will accept the plug. The marked rating of the extension cord must be equal to or greater than the electrical rating of the appliance.

DO NOT USE EXTENSION CORD LONGER THAN 12 FT.

INSTALLATION GUIDE

INSTALLATION LIMITATIONS

- Select a suitable location for the refrigerator on a hard even surface away from direct sunlight or heat source, e.g. radiators, baseboard heaters, cooking appliances, etc. Any floor unevenness should be corrected with the leveling legs located on the front bottom corners of the refrigerator.

UNPACKING YOUR REFRIGERATOR

1. Remove all packaging material. This includes the corrugated base and all adhesive tape holding the refrigerator accessories inside and outside.
2. Inspect and remove any remains of packing, tape or printed materials before powering on the refrigerator.

NOTE: If your refrigerator comes with a snack pan, remove the blue adhesive tape from the rear of the pan. The pan will not slide in and out without removing the tape.

INSTALLATION GUIDE CONT.

LEVELING YOUR REFRIGERATOR

- All four corners of the cabinet must rest firmly on the floor
- The cabinet must sit level from side to side
- The cabinet must tilt slightly (1/4" or 6mm) from front to back for the doors to seal properly
- Turn leveling legs counterclockwise to raise the cabinet

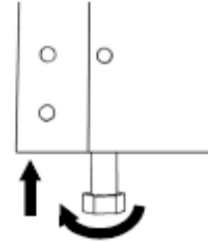

PROPER AIR CIRCULATION

- To ensure your refrigerator works at the maximum efficiency it was designed for, you should install it in a location where there is proper air circulation, plumbing and electrical connections. Your refrigerator is not design to operate in temperatures below 55°F (12°C) or above 95°F (35°C).
- Do not install your refrigerator in any location not properly insulated or heated, e.g. garage, etc. Keep out of direct sunlight and away from heating sources such as radiators, heaters, and cooking appliances.
- The following are recommended clearances around the refrigerator:
 Sides and Top.....1" (25 mm) Back.....2" (50mm)

FRONT GRILLE

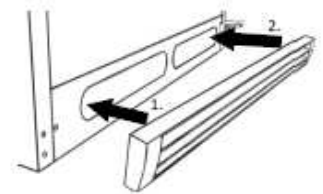

TOOLS NEEDED FOR INSTALLATION

DO NOT USE POWER TOOLS TO INSTALL DOOR HANDLES!

OVERTIGHTENING THE SCREWS COULD STRIP THE THREADS!

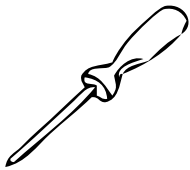

Phillips Screwdriver

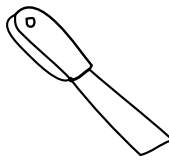

Putty Knife

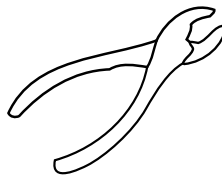

Pliers

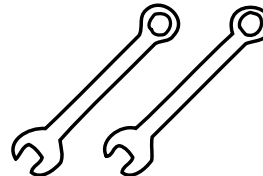

5/16 and 3/8 Wrenches or Adjustable Wrench

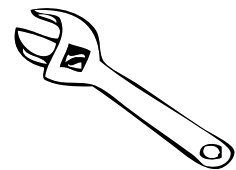

PARTS INCLUDED

PARTS INCLUDED MAY DIFFER BASED ON UNIT PURCHASED

For models that come with a handle mounting screw installed on the faces of the doors, the parts included will consist of:

- 2 Handles
- 1 Front grille
- 4 Handle attachment screws
- Owner's manual

For models that don't come with a handle mounting screw installed on the face of the door, the parts included will consist of:

- 2 Handles
- 1 Front grille
- 2 Door face mounting screws
- 4 Door edge mounting screw
- 2 Handle cover/trim pieces
- Owner's manual

ACCESSORIES

The following accessories are available:

- Ice maker Kit HI5MK
- Wire Shelf for Freezer Compartment
- Replacement Light Bulbs

To order accessories, call 1-877-337-3639 or visit us at www.haieramerica.com/support

REVERSING THE DOORS

DOOR REMOVAL/REVERSAL

1. Remove front grille (if already installed)
2. Remove top hinge cover and top hinge. Lift freezer door off center hinge and set aside.
3. Unscrew center hinge pin. Be sure to retain plastic washer(s) for reinstallation. Remove refrigerator door from bottom hinge and set aside.
4. Remove center hinge and plastic spacer(s) by unscrewing center bolt, loosening side bolts and sliding hinge to the center of the cabinet. Tighten bolts.
5. Remove the center bolt on the opposite side, loosen side bolts and slide center hinge and spacers behind side bolts. Re-install center bolt and tighten side bolts.
6. Remove bottom hinge bolts and relocate bottom hinge to opposite side of cabinet. Tighten bolts.
7. Unscrew bottom hinge pin, move to other hinge hole and tighten.
8. Relocate door stops (bottom of both doors), hinge hole covers and handle screw plugs (if reversing doors) on both doors to the opposite side of the doors.
9. Place refrigerator door on bottom hinge pin. Align hinge hole in door with hole in center hinge. Insert center hinge pin and tighten.
10. Place freezer door on center hinge pin and close.
11. Insert top hinge pin into hinge hole in top of freezer door. Align with bolts holes in top of cabinet and tighten bolts. Replace top hinge cover.
12. Flip over front grille and reinstall.
13. See door handle instructions to remove and re-install handles.

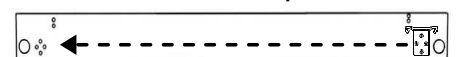
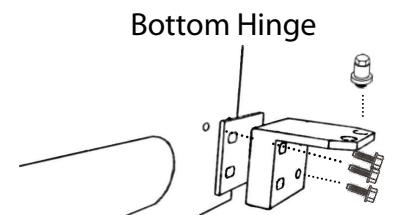
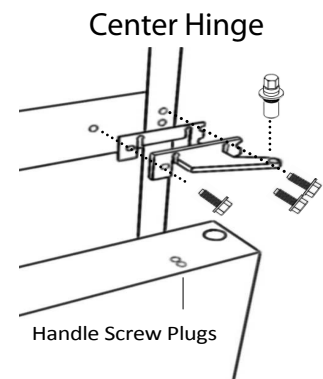
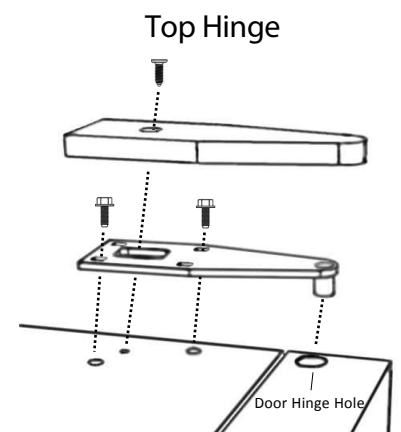

LOGO BADGE RELOCATION

When reversing doors:

1. Use pliers to remove logo badge by grasping firmly and twisting
2. Immediately center over screw in opposite side of door and press firmly

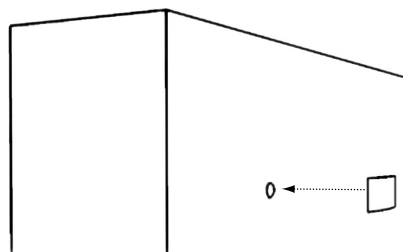
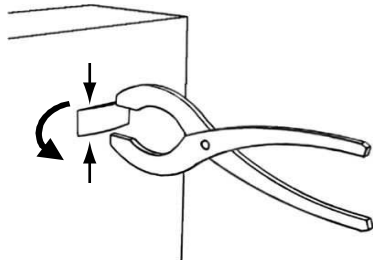

DOOR HANDLE INSTALLATION

For models with pre-installed handle-mounting screws on the faces of the doors

1. Remove door handles from plastic bags.
2. Slide the flared end of the handle over the pre-installed door face mounting screw. Slide handle down to secure it.
3. Rotate door handle toward the space between the doors.
4. Install screws from parts-included bag but do not tighten fully.
5. Repeat above steps for remaining door.
6. With both handles mounted, visual align handles, carefully open door and tighten screws.

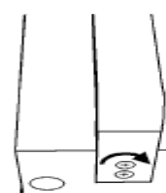
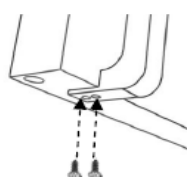
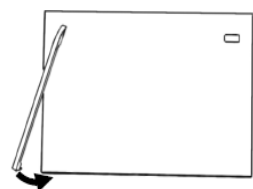
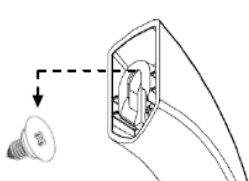

For models without pre-installed handle-mounting screws on the faces of the doors

1. Remove door handles, screws and handle trim pieces from plastic bags.
2. Mount the tapered end of the handle to the door face using one of the two door face screws.
3. Install screws from parts-included bag into handle bottom/top flange but do not tighten fully.
4. Repeat above steps for remaining door.
5. With both handles mounted, visual align handles, carefully open door and tighten screws.
6. Attach handle trim pieces to handles.

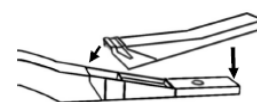
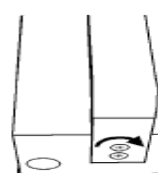
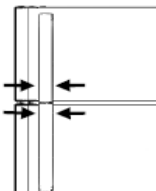
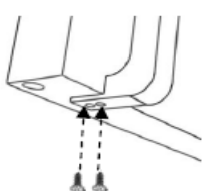
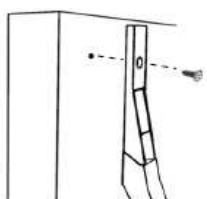

FEATURES AND USE

NOTE: All features not available on all models.

NOTE: If refrigerator has been placed in a horizontal position for any period of time, wait 4 hours after returning it to the upright position before plugging it in.

CONTROLS

Allow 24 hours for all adjustments.

Temperature controls should be set straight up at the "mid" setting and adjusted in small increments after 24 hours to achieve desired temperature.

Adjusting the refrigerator control will affect the freezer compartment as well.

Turning either control to "Off" or the lowest setting does not remove power supply from the refrigerator.

Refrigerator Temperature

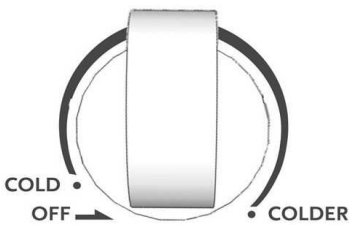

Freezer Temperature

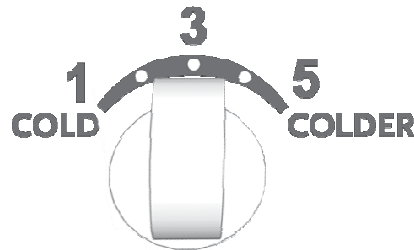

Crisper



LIGHT COVERS (NOT ALL MODELS)

Main Refrigerator

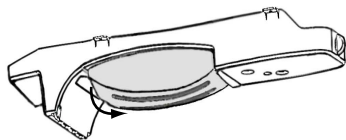

Freezer
(Not All Models)

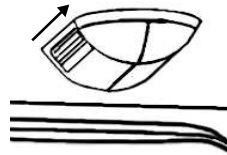

Mid-Level Refrigerator
(Not All Models)

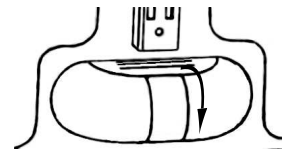

PROPER CARE AND MAINTENANCE



WARNING

Before cleaning your refrigerator, ALWAYS unplug it from the power source. Failure to heed this warning could result in injury or death from electric shock.

NOTE: Before using any cleaning products, be sure to read the manufacturer's instructions and warnings. This will help avoid personal injury or damage to property.

INTERIOR CLEANING:

Prepare a cleaning solution of 3-4 tablespoons of baking soda mixed with warm water. Use a sponge or soft cloth, dampened with the cleaning solution, to wipe the inside of your refrigerator.

Avoid cleaning any cold glass (shelves, crisper cover glass, etc.) with hot water. The glass can break and cause personal injury. Handle all glass parts with care at all times.

Do not attempt to wash any parts in a dishwasher.

Do not use harsh chemicals, ammonia, chlorine bleach, concentrated detergent, solvents, abrasives or metal scouring pads to clean your refrigerator, inside or out. They can damage and/or discolor the refrigerator finish.

EXTERIOR CLEANING:

Use a clean, soft, lightly dampened cloth with kitchen appliance wax or a mild detergent to clean the exterior of the refrigerator.

Use a clean, soft, lightly dampened cloth with warm soapy water to clean the handles and trim. Use a clean, soft towel to dry.

For stainless steel models, use a dry cloth and stainless steel polish.

Door gaskets should be cleaned every three months following the instructions for interior cleaning. Clean gaskets will maintain a better seal than dirty gaskets. Lightly apply petroleum jelly to the hinge side of the gaskets to keep the gasket pliable and assure a good seal.

Never use a dirty cloth to clean the exterior of the refrigerator. Dirty cloths may leave residue on the refrigerator that can damage the finish. Also, avoid the use of harsh chemicals, ammonia, chlorine bleach, concentrated detergent, solvents, abrasives or metal scouring pads to clean the outside of the refrigerator.

LIGHT BULB REPLACEMENT



WARNING

Before changing a bulb, ALWAYS unplug unit from the power source. Failure to heed this warning could result in injury or death from electric shock.

1. In order to replace a light bulb, first unplug your refrigerator from the power outlet.
2. After allowing bulb to cool, turn bulb counter-clockwise in order to remove it from the socket.
3. Screw a new bulb into the socket by turning the bulb clockwise.
4. Plug in your refrigerator and open the door to check that the bulb is working.

LIGHT BULB REPLACEMENT GUIDE

Use the guide below to determine the appropriate bulb for each fixture:

Upper Refrigerator Light - 40 W Daylight Appliance Bulb (1 or 2, depending on model)

Mid-Level Refrigerator Light - 25 W Appliance Bulb

Freezer Light - 25 W Appliance Bulb

All bulbs have medium bases

PROPER CARE AND MAINTENANCE

POWER INTERRUPTIONS

In the event of a power interruption, unplug your refrigerator from the power source. Avoid opening the doors until after power has been restored.

Your refrigerator will maintain a cold temperature for longer if door opening is avoided or kept to a minimum.

Once power has been restored, plug your refrigerator back into the power source and inspect food in the refrigerator for spoilage or thawing. Cleaning your refrigerator after a prolonged power outage is strongly recommended to avoid odors and potential health hazards due to thawing.

VACATIONS

For long vacations or absences, unplug your refrigerator and remove all food from it. Turn the temperature control knob in the refrigerator section to the OFF position and clean the refrigerator, including the gaskets, according to the Proper Care and Maintenance section. Leave the doors propped open to allow air to circulate inside the refrigerator.

MOVING

Before moving your refrigerator, empty the food from it and use adhesive tape to secure all loose items such as shelves, door bins and racks, crispers and pans, etc. and unplug it. Always move the refrigerator in an upright position in order to avoid damaging the sealed refrigerant system.

NORMAL OPERATING SOUNDS

WHIRRING

There are multiple high-speed fans inside your refrigerator which help it to maintain the temperature you have selected. Whirring is common when the refrigerator is first plugged in, when the doors have been opened often or for an extended period of time and when a large amount of food has been added.

HUMMING

This is a common noise that comes from the compressor and is a part of making your refrigerator run efficiently.

WHOOSHING

It is possible that you may hear a whooshing noise when closing the doors. This is no cause for concern. It is simply the pressure in the refrigerator equalizing.

OTHER NOISES

- There are a lot of things going on in your refrigerator at any given time. Additional noises you may hear, and possible causes include:
- Gurgling is most likely due to the circulation of refrigerant through the cooling coils.
- Sizzling or popping sounds can be frost melting and falling onto the defrost heater during the defrost cycle.
- Clicking or chirping may be heard as the compressor attempts to re-start.
- Cracking or popping noises may be from the expansion and contraction of cooling coils during and after the defrost cycle.
- Also, when your refrigerator is first plugged in, the foam insulation in the walls will cool and contract, which can result in cracking or popping noises.
- The defrost timer and thermostat control will click as each cycles on and off.

TROUBLESHOOTING

PROBLEM	POSSIBLE CAUSE(S)	SOLUTION
Refrigerator does not run	Temperature Control Knob is set to OFF	Turn temperature knob clockwise to turn on cooling system
	Refrigerator is unplugged	Plug power cord into power source
	Breaker is tripped or turned off / Fuse is blown	Reset / Turn on breaker or replace fuse
	Refrigerator is in defrost mode	Wait about 40 minutes for defrost cycle to end and cooling system to restart
Refrigerator or freezer is too warm	Temperature control is not set low enough	Turn temperature knob clockwise to adjust to a lower temperature; allow 24 hours to adjust
	Doors opened frequently or left open	Keep door closed / Check that a package isn't preventing door from closing
	Warm food added recently	Allow time for food and refrigerator to cool
	Items against back of compartments are blocking proper airflow	Store items only inside the trim of the glass shelves; don't place items against sides of the compartments or directly in front of any vents
Refrigerator or freezer is too cold	Temperature control is set too low	Turn knob counter-clockwise to change to a warmer setting; allow 24 hours to adjust
Refrigerator runs frequently or for long periods of time	Normal when first plugged in	Allow 24 hours for the refrigerator to cool down
	Warm or large amounts of food added	This is normal
	Door is left open	Ensure that door is not being held open by an item
	Hot weather or frequent openings	This is normal
	Temperature control set to coldest setting	Adjust knob to a warmer setting
Moisture on exterior/interior of refrigerator	High humidity	This is normal; Dry surface and adjust temperature knob to slightly colder setting
	Doors opened frequently or left open	Keep door closed / Check that a package isn't preventing door from closing
	Open container of water in refrigerator	Cover or seal container
Refrigerator has an odor	Food is not sealed or packaged properly	Re-seal packaging / Place an opened box of baking soda in the refrigerator, replace every three months
	Interior needs to be cleaned	Follow cleaning instructions in Proper Care and Maintenance section
Light does not come on	Refrigerator is unplugged	Plug refrigerator in to power source
	Bulb is loose	Tighten bulb by turning clockwise
	Bulb is burned out	Follow instructions in Light Bulb Replacement section
	Not all models come with a freezer or mid level light	



TROUBLESHOOTING CONT.

PROBLEM	POSSIBLE CAUSE(S)	SOLUTION
Frost or ice crystals on frozen food	Freezer door left open or opened frequently	Turn knob counter-clockwise to change to a warmer setting; allow 24 hours to adjust
	Items blocking freezer air vents and preventing proper air flow	Move items away from rear wall
Hot or warm air from bottom of refrigerator	Air flow coming from compressor during refrigeration process	This is normal
Food freezing in refrigerator	Food placed to close the air vent	Move items away from back and top of the refrigerator
	Temperature control knob set too low	Adjust the knob counter-clockwise to a warmer setting
Freezer door pops open when closing the refrigerator door	Normal if freezer door closes afterwards on its own	This indicates a good seal if freezer door closes on its own
	If freezer doesn't close on its own after popping open, adjust leveling legs	See leveling leg feature instructions in Installing Your Refrigerator section
Door does not close properly	Refrigerator isn't level	See leveling leg feature instructions in Installing Your Refrigerator section
	Something is obstructing door closure	Check for and remove obstructions
Vibration or rattling	Refrigerator is not resting firmly on floor	See leveling leg feature instructions in Installing Your Refrigerator section

CUSTOMER SERVICE

IMPORTANT

DO NOT RETURN THIS PRODUCT TO THE STORE

If you have a problem with this product, please contact the Haier Customer Satisfaction Center at 1-877-337-3639.

DATED PROOF OF PURCHASE, MODEL # AND SERIAL #
REQUIRED FOR WARRANTY SERVICE



LIMITED WARRANTY

What is covered and for how long?

This warranty covers all defects in workmanship or material for a period of:

12 Months on Parts and Labor

5 Years on Sealed System

This warranty commences on the date the item was purchased and the original purchase receipt must be presented to the authorized service center before any warranty service is rendered.

Exceptions: Commercial or Rental Use

90 Days on Labor (Carry-In Only)

90 Days on Parts

No Other Warranty Applies

What is Covered:

The mechanical and electrical parts, which serve a functional purpose of this appliance for a period of 12 months from the date of purchase. This includes all parts except finish and trim.

The components of the sealed system (e.g. hermetic compressor, condenser and evaporator) from manufacturing defects for a period of 5 years from the date of purchase. Any damage to such components caused by mechanical abuse or improper shipping and handling will not be covered.

What will be done?

We will repair or replace, at our discretion, any mechanical or electrical part which proves to be defective in normal usage during the warranty period as specified.

There will be no charge to the purchaser for parts and labor on any covered items during the initial 12 month period. Beyond this period, only parts are covered in the remaining warranty. Labor is not provided and must be paid by the consumer.

What to do if you need service:

Contact your nearest authorized service center.

For the name of the nearest service center, please call 1-877-337-3639.

THIS WARRANTY COVERS APPLIANCE S WITH IN THE CON TINEN TAL UNITED STATES AND CANA DA. TH IS WARRAN TY DOES NOT COVER THE FOLLO WING :

- Service calls to correct the installation on your refrigerator
- Service calls to instruct you on proper use of your refrigerator
- Service calls to replace or correct house wiring or plumbing
- Service calls to replace light bulbs
- Damages from improper installation
- Damages from shipping
- Defects other than manufacturing
- Damage from misuse, abuse, accident, alteration, lack of proper care and maintenance or incorrect current or voltage
- Damage from use other than household use
- Damage from service performed by a non-authorized dealer or service center
- Decorative trim
- Transportation and shipping
- Labor (after the initial 12 month warranty period)

TH IS LIMITED WARRAN TY IS GIVEN IN LIE U OF ALL OTH ER WARRAN TIES, EX PRESS ED OR IMPLIE D, INCL UDING THE WARRAN TIES OF MERCHANTABI LI TY AND FITNE SS F OR A PART IC ULAR PURP OSE

The remedy provided in this warranty is exclusive and is granted in lieu of all other remedies. The warranty does not cover incidental or consequential damages, so the above limitations may not apply to you. Some states do not allow limitations on how long an implied warranty lasts, so the above limitations may not apply to you. This warranty gives you specific legal rights and you may have other rights which vary from state to state.

Haier America
New York, NY 10018

www.HaierAmerica.com

Model # HT Series
Issued: January 2012
115 V, 60 Hz

Assembled in U.S.A.
Fabriqué en É.-U.
Hecho en EE. UU.

Printed in the U.S.A.
Imprimé aux É.-U.
Impreso en los EE. UU.

Haier America
New York, NY 10018
©2012 Haier America Trading, LLC.

JANUARY 2012

HT18TS45SW

