

morphy richards®

aspect

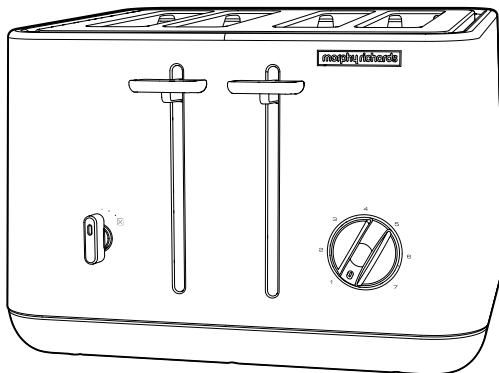

Aspect toaster

Please read and keep these instructions



AUS



www.morphyrichards.com



Health and Safety

The use of any electrical appliance requires the following common sense safety rules.

Please read these instructions carefully before using the product.

- This appliance can be used by children aged from 8 years and above and persons with reduced physical, sensory or mental capabilities, or lack of experience and knowledge, if they have been given supervision or instruction concerning the use of the appliance in a safe way and understand the hazards involved.
- Children shall not play with the appliance.
- Cleaning and user maintenance shall not be made by children unless they are older than 8 years and supervised.
- Keep the appliance and its cord out of reach of children less than 8 years.
- The bread may burn, therefore do not use the appliance near or below combustible material such as curtains.
- This appliance is not intended to be operated by means of an external timer or separate remote control system.

The use of any electrical appliance requires the following common sense safety rules.

WARNING: Danger to the person!

IMPORTANT: Damage to the appliance!

In addition, we offer the following safety advice.

Location

- This appliance is intended to be used in household and similar applications such as:
farm houses;
by clients in hotels, motels and other residential type environments;
bed and breakfast type environments.
It is not suitable for use in staff kitchen areas in shops, offices and other working environments.

Mains cable

- Do not let the cable run across a cooker or hot area which might damage the cable.
- If the supply cable is damaged, it must be replaced by the manufacturer, its service agent or similarly qualified persons in order to avoid a hazard.
Other safety considerations
- Only use for intended purpose.

Personal safety

- **WARNING: Do not touch the top of the appliance or other hot parts during or after use, use handles or knobs.**
- **WARNING: Do not wrap the cable around the main body of the appliance during or after use.**
- **WARNING: Do not insert oversize foods, metal, foil packages or utensils into the toaster.**
- **WARNING: Do not attempt to dislodge food when the appliance is plugged in and never insert cooking utensils into the slots.**
- **IMPORTANT:** Do not place bread or other items on top of the slots as this may damage the appliance and creates a fire hazard.

Precautions

- Never switch on the appliance when it is empty (when there is no bread inside) except on first use.
- Clean the crumb tray regularly: crumbs can smoke or burn.
- Do not insert forks or other utensils into the toaster in order to remove bread. As well as damaging the toaster, there is a high risk of electric shock.
- Should some toast remain blocked in the toaster, remove the plug from the mains, wait for the toaster to cool down until it is safe to touch, then turn the toaster over and shake it gently.

Electrical requirements

Should the fuse in the mains plug require changing, a 13 amp BS1362 fuse must be fitted.

WARNING: This appliance must be earthed.



CAUTION!
HOT SURFACE

**PLEASE BE AWARE
OF HOT SURFACES
HANDLE WITH CARE**

Treating scalds

- Run cold water over the affected area immediately.
- Do not stop to remove clothing.
- Seek medical advice quickly.

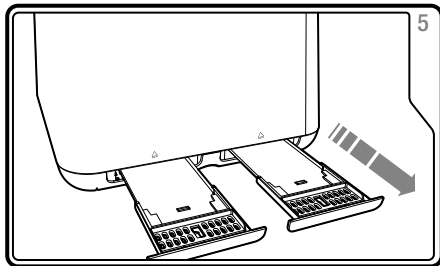
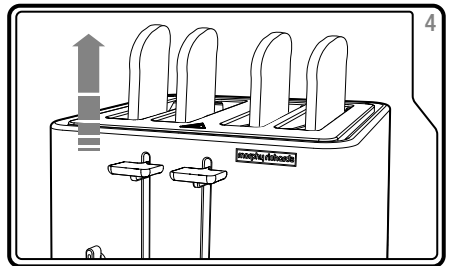
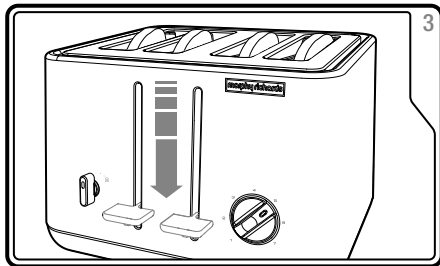
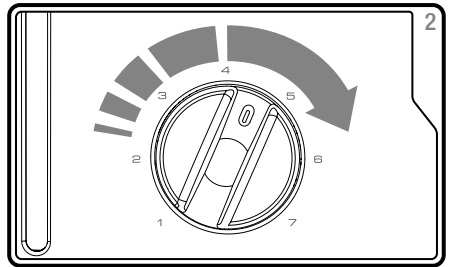
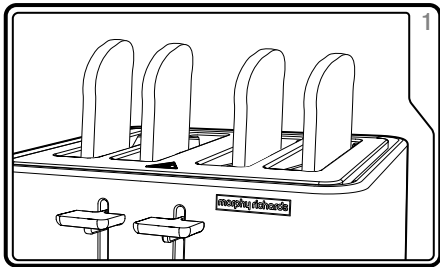
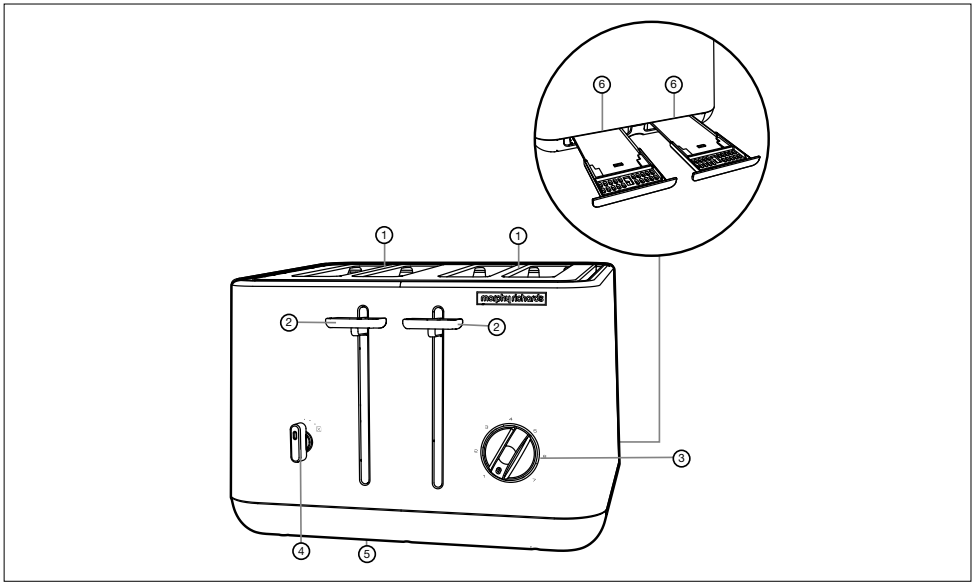

Features

- (1) Bread Slots
- (2) Bread Carriage Levers
- (3) Browning Control
- (4) Cancel Switch
- (5) Cable Storage (underneath)
- (6) Crumb Tray (at rear)

Before first use

- Before using your toaster for the first time, operate the toaster without bread.
- As with all new electric heating elements, your toaster will emit a 'new' smell when it is first switched on. This is quite normal and not a cause for concern.

Using your toaster

- 1** Place the sliced bread into the Bread Slots (1).
- 2** Adjust the Browning Control (3) to the desired setting.
- 3** Lower the Bread Carriage Lever(s) (2). The toaster will begin toasting the bread.
- 4** When completed, the Bread Carriage Lever(s) will automatically rise and lift the toast from the toaster.

Checking your toast

During toasting, raise the Bread Carriage Lever(s) (2) to check on the progress of your bread/toast. After looking, lower the Bread Carriage Lever(s) to the original position. The toasting time will not be affected or paused during this process. If the toast is ready, turn the Cancel Switch (4) clockwise to cancel the toasting process.

Cancel Switch (4)

If you wish to stop the toasting process, turn the Cancel Switch clockwise. The heating process will stop and the bread will rise.

Browning Control (3)

Reheat

To reheat already toasted bread, turn the Browning Control to position 1 and press the Bread Carriage Lever (2) down. Your toaster will reheat your toast.

Defrost

To defrost frozen bread for toasting, adjust the Browning Control by increasing the browning level by 1 from your desired browning level. (E.g. increasing 4 to 5), and lower the Bread Carriage Lever. This will defrost and toast your bread to the desired level.

Removing the Crumb Tray

WARNING: Crumbs will accumulate in the Crumb Trays (6) and could ignite if not emptied regularly.

1. When the appliance has cooled down completely, tap the sides of the case lightly to dislodge any crumbs lodged in the Bread Slots (1).
2. Press the Crumb Trays to unlock and remove from the toaster.
3. Empty the Crumb Trays and replace, push to lock back into place.

IMPORTANT: Never operate the appliance without the Crumb Trays fitted.

Hints and tips

- In order to achieve uniform browning, we recommend you wait a minimum of 30 seconds between each toasting cycle, so that the control can be automatically reset.
- If toasting one slice only, you may need to adjust the Browning Control (3) to a slightly lower setting. You may notice a slight variation in toast colour on one side of a single slice.
- When toasting 2 slices it is recommended they are of equal size and freshness.
- Stale bread toasts more rapidly than fresh bread. Therefore, the Browning Control should be set at a lower setting than usual.
- All sorts of bread can be used as well as teacakes, small rolls etc. Slices should not however be so thick as to cause burning or jamming within the Bread Slots (1).
- If the bread in your toaster becomes jammed disconnect your toaster at the socket, allow it to cool, then remove the bread.
- Allow the toaster to cool fully before putting away.
- Do not use very thin or broken slices of bread.
- Do not insert other foods that may drip during the cooking process. In addition to making the cleaning procedure more difficult, these may cause fires.
- Do not insert (by force) foods that are too big for the slots.
- Do watch your appliance during use.

Care and cleaning

- Before cleaning, unplug your toaster and let it cool down.
- The external part of the appliance must be cleaned with a soft cloth. Do not use abrasive detergents that can ruin the surface.
- **DO NOT IMMERSE IN WATER.**
- Regularly, remove the plug from the electrical outlet and empty the Crumb Trays (6) that are under the appliance.

DO NOT TOUCH ANY PART OF THE TOASTER WITH SHARP OR METAL UTENSILS, ESPECIALLY INSIDE THE BREAD TOASTING SLOTS. RISK OF ELECTRIC SHOCK AND DAMAGE TO THE TOASTER.

AUS

Contact us

Helpline

If you are having a problem with your appliance, please call our Helpline, as we are more likely to be able to help than the store you purchased the item from.

Please have the product name, model number and serial number to hand when you call to help us deal with your enquiry quicker.

Talk To Us

If you have any questions or comments, or want some great tips or recipe ideas to help you get the most out of your products, join us online:

Blog: www.morphyrichards.co.uk/blog
Facebook: www.facebook.com/morphyrichardsuk
Twitter: [@loveyourmorphy](https://twitter.com/loveyourmorphy)
Website: www.morphyrichards.com

THIS SECTION IS ONLY APPLICABLE FOR CUSTOMERS IN UK AND IRELAND

REGISTERING YOUR TWO YEAR GUARANTEE

Your standard one year guarantee is extended for an additional 12 months when you register the product within 28 days of purchase with Morphy Richards. If you do not register the product with Morphy Richards within 28 days, your product is guaranteed for 1 year. To validate your 2 year guarantee register with us online at www.morphyrichards.co.uk

N.B. Each qualifying product needs to be registered with Morphy Richards individually. Please refer to the one year guarantee for more information.

YOUR ONE YEAR GUARANTEE

It is important to retain the retailer's receipt as proof of purchase. Staple your receipt to this back cover for future reference. Please quote the following information if the product develops a fault. These numbers can be found on the base of the product.

Model no.
Serial no.

All Morphy Richards products are individually tested before leaving the factory. In the unlikely event of any appliance proving to be faulty within 28 days of purchase, it should be returned to the place of purchase for it to be replaced. If the fault develops after 28 days and within 12 months of original purchase, you should contact the Helpline number quoting Model number and Serial number on the product, or write to Morphy Richards at the address shown. You may be asked to return a copy of proof of purchase. Subject to the exclusions set out below (see Exclusions), the faulty appliance will then be repaired or replaced and dispatched usually within 7 working days of receipt. If, for any reason, this item is replaced during the 1 year guarantee period, the guarantee on the new item will be calculated from original purchase date. Therefore it is vital to

retain your original till receipt or invoice to indicate the date of initial purchase. To qualify for the 1 year guarantee, the appliance must have been used according to the instructions supplied. For example, crumb trays should have been emptied regularly.

EXCLUSIONS

Morphy Richards shall not be liable to replace or repair the goods under the terms of the guarantee where:

- 1 The fault has been caused or is attributable to accidental use, misuse, negligent use or used contrary to the manufacturer's recommendations or where the fault has been caused by power surges or damage caused in transit.
- 2 The appliance has been used on a voltage supply other than that stamped on the products.
- 3 Repairs have been attempted by persons other than our service staff (or authorised dealer).
- 4 The appliance has been used for hire purposes or non domestic use.
- 5 The appliance is second hand.
- 6 Morphy Richards are not liable to carry out any type of servicing work, under the guarantee.
- 7 Plastic filters for all Morphy Richards kettles and coffee makers are not covered by the guarantee.
- 8 Batteries and damage from leakage are not covered by the guarantee.
- 9 The filters have not been cleaned and replaced as instructed.

This guarantee does not confer any rights other than those expressly set out above and does not cover any claims for consequential loss or damage. This guarantee is offered as an additional benefit and does not affect your statutory rights as a consumer.

YOUR INTERNATIONAL TWO YEAR GUARANTEE

This appliance is covered by two-year repair or replacement warranty.

It is important to retain the retailers receipt as proof of purchase. Staple your receipt to this back cover for future reference.

Please quote the following information if the product develops a fault. These numbers can be found on the base of the product.

Model no.
Serial no.

All Morphy Richards products are individually tested before leaving the factory. In the unlikely event of any appliance proving to be faulty within 28 days of purchase it should be returned to the place of purchase for it to be replaced.

If the fault develops after 28 days and within 24 months of original purchase, you should contact your local distributor quoting Model number and Serial number on the product, or write to your local distributor at the addresses shown.

You will be asked to return the product (in secure, adequate packaging) to the address below along with a copy of proof of purchase.

Subject to the exclusions set out below (1-9) the faulty appliance will then be repaired or replaced and dispatched usually within 7 working days of receipt.

If for any reason this item is replaced during the 2-year guarantee period, the guarantee on the new item will be calculated from original purchase date. Therefore it is vital to retain your original till receipt or invoice to indicate the date of initial purchase.

To qualify for the 2-year guarantee the appliance must have been used according to the manufacturers instructions. For example, appliances must have been descaled and filters must have been kept clean as instructed.

The local distributor shall not be liable to replace or repair the goods under the terms of the guarantee where:

- 1 The fault has been caused or is attributable to accidental use, misuse, negligent use or used contrary to the manufacturers recommendations or where the fault has been caused by power surges or damage caused in transit.
- 2 The appliance has been used on a voltage supply other than that stamped on the products.
- 3 Repairs have been attempted by persons other than our service staff (or authorised dealer).
- 4 Where the appliance has been used for hire purposes or non domestic use.
- 5 The appliance is second hand.
- 6 The local distributor are not liable to carry out any type of servicing work, under the guarantee.
- 7 The guarantee excludes consumables such as bags, filters and glass carafes.
- 8 Batteries and damage from leakage are not covered by the guarantee.
- 9 The filters have not been cleaned and replaced as instructed.

This guarantee does not confer any rights other than those expressly set out above and does not cover any claims for consequential loss or damage. This guarantee is offered as an additional benefit and does not affect your statutory rights as a consumer.

AUSTRALIAN WARRANTY

This appliance is guaranteed for 2 years against faulty material, components and workmanship.

This warranty is in addition and does not affect your statutory rights.

Proof of purchase must be produced for any warranty benefit.

In the unlikely event of any appliance proving to be faulty, securely pack and return the item to the place of purchase accompanied by the original receipt or invoice.

Our goods come with guarantees that cannot be excluded under the Australian Consumer Law. You are entitled to a replacement or refund for a major failure and for compensation for any other reasonably foreseeable loss or damage. You are also entitled to have the goods repaired or replaced if the goods fail to be of acceptable quality and the failure does not amount to a major failure.

NOT COVERED BY THIS WARRANTY

(Australian only)

- If the appliance has not been used in accordance with the manufacturers' recommendations or Instructions.
- If the fault is deemed to be caused by abuse, misuse, neglect, modifications or in proper use and or care
Eg: Kettles: Excessive build up of scale.
Toasters: Excessive build up of crumbs or foreign matter etc.
- Connection to incorrect voltage to that stamped on the product.
- Unauthorised repairs.
- Appliance used other than for domestic purposes.
- Excluding bags, filters, glass, carafes, and cutting blades.
- Freight and insurance costs.

If for any reason this item is replaced during the 2 year guarantee period, the guarantee on the new item will be calculated from original purchase date. Therefore it is vital to retain your original receipt or invoice to indicate the date of original purchase.

Morphy Richards's policy is to continually improve quality design and product quality. The company therefore reserves the right to change any specifications or to carry out modifications as deemed worthy at any time.

The Australian supplier reserves the right to repair, modify, exchange or replace the faulty appliance with the same or similar model or product of equivalent value.

AUS

AUS Glen Dimplex Australia

Unit 1, 21 Lionel Road, Mount Waverley, Victoria 3149

T : 1300 556 816

E : sales@glendimplex.com.au

NZ Glen Dimplex New Zealand

38 Harris Road, East Tamaki, Auckland, New Zealand

T : 09 2748265

E : sales@glendimplex.co.nz

morphyrichards®

TT240002MAUS Rev 1 11/14

www.morphyrichards.com