

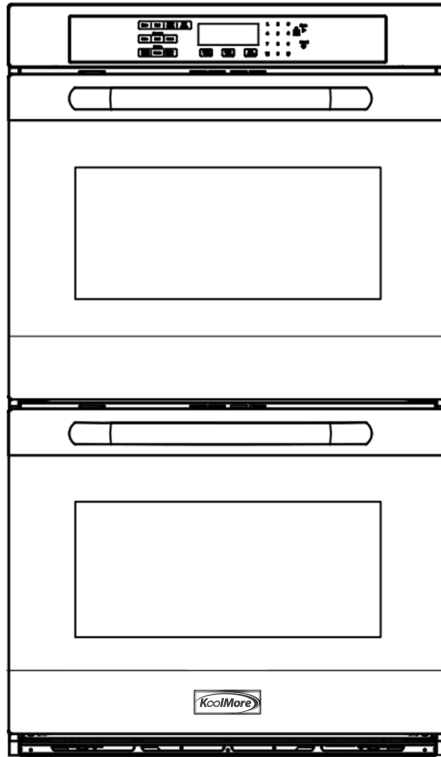

User Manual

30" Built-In Double Wall Oven

Model : KM-WO30D-SS



For any service-related Issues, please contact us:

Phone Number: 718-576-6342

Email address: support@koolmore.com



IMPORTANT SAFETY INSTRUCTIONS:

**CAREFULLY READ THE IMPORTANT INFORMATION
REGARDING INSTALLATION, SAFETY AND MAINTENANCE.
KEEP THESE INSTRUCTIONS FOR FUTURE REFERENCE.**

WARRANTY

LIMITED WARRANTY

LIMITED WARRANTY KOOLMORE SUPPLY, INC. warrants to the original consumer or purchaser this KOOLMORE product is free from defects in material or workmanship for a period of One (1) year from the date of purchase. If any such defect is discovered within the warranty period, KOOLMORE SUPPLY, INC., at its discretion, will repair or replace the product at no cost or pay for replacement parts and repair labor to correct defects in materials or workmanship that existed when this major appliance was purchased or that are the result of normal usage when this major appliance is installed, operated and maintained according to instructions attached to or furnished with the product,

At its sole discretion. Koolmore Supply Inc may determine to replace the product. In the event of product replacement, your appliance will be warranted for the remaining term of the original unit's warranty period.

This limited warranty is good only to the original purchaser of the product and effective only when used in the United States.

This limited warranty is effective from the date of original consumer purchase. Proof of original purchase date is required to obtain service under this limited warranty.

YOU'RE SOLE AND EXCLUSIVE REMEDY UNDER THIS LIMITED WARRANTY SHALL BE PRODUCT REPAIR AS PROVIDED HEREIN. Service must be provided by a Koolmore designated service company.

For warranty or repair service: Email us at support@koolmore.com include your name, address, phone number, warranty repair request, and a copy of your proof of purchase receipt.

You can also visit us at koolmore.com and use the contact us page.

KOOLMORE customer service will contact you and arrange prompt service for your appliance.

Thank you for choosing KOOLMORE.

THIS LIMITED WARRANTY DOES NOT APPLY TO

- 1.Failure of product to perform during power failures and interruptions or inadequate electrical service
- 2.Damage caused by transportation or handling.
- 3.Damage caused to the product by accident, vermin, lightning winds, fire, floods, or acts of God.
- 4.Damage resulting from accident, alteration, misuse, abuse, or improper installation, repair, or maintenance. Improper use includes using an external device that alters or converts the voltage or frequency of electricity
- 5.Any unauthorized product modification, repair by unauthorized repair center, or use of non-approved replacement parts.
- 6.Abnormal cleaning and maintenance as described in the user's manual.
- 7.Use of accessories or components that are not compatible with this product.

The cost of repair or replacement under these excluded circumstances shall be borne by the consumer.

TABLE OF CONTENTS

OVEN SAFETY	2
Warnings for Electric Installation.....	3
PARTS AND FEATURES	6
CONTROL PANEL	7
Oven Mode Controls	7
Display.....	7
Start/Control Lockout.....	7
Cancel.....	8
Light	8
Timer	8
Cook Time	8
Start Time	9
Settings.....	10
Self-Clean	12
OVEN USE	12
Before Using the Oven	12
General.....	12
Oven Temperature Control.....	15
Oven Modes.....	16
Convection (Upper Oven Only).....	19
Bake Tips	21
Convection Bake Tips.....	22
Convection Roast Tips	24
Convection Broil Tips	26
Dehydrate Tips	26
Broil Tips.....	28
Food Service Temperature Guidelines from FSIS.....	29
OVEN CARE	30
General Cleaning	30
Automatic Self-Cleaning.....	33
Oven Door Removal	35
Replacing an Oven Light.....	37
TROUBLESHOOTING	38
Baking and Roasting	38
Operation.....	39

OVEN SAFETY

Your safety and the safety of others are very important.

We have provided many important safety messages in this manual and on your appliance. Always read and obey all safety messages.



This is the safety alert symbol.

This symbol alerts you to potential hazards that can kill or hurt you and others. All safety messages will follow the safety alert symbol and either the word "DANGER," "WARNING" or "CAUTION."

These words mean:



An imminently hazardous situation. You could be killed or seriously injured if you don't immediately follow instructions.



A potentially hazardous situation which, if not avoided, could result in death or serious bodily injury.



A potentially hazardous situation which, if not avoided, may result in moderate or minor injury.

All safety messages will tell you what the potential hazard is, tell you how to reduce the chance of injury, and tell you what can happen if the instructions are not followed.

State of California Proposition 65 Warnings:

WARNING: This product contains one or more chemicals known to the State of California to cause cancer.

WARNING: This product contains one or more chemicals known to the State of California to cause birth defects or other reproductive harm.

WARNINGS FOR ELECTRIC INSTALLATION

WARNING



Electrical Shock Hazard

Installation and service must be performed by a qualified installer or service agency.

The models may be powered at 240V or 208V.

Always disconnect the power before servicing this unit.

This appliance must be properly grounded.

Failure to do so could result in death or serious injury.

IMPORTANT SAFETY INSTRUCTIONS

WARNING: To reduce the risk of fire, electrical shock, injury to persons, or damage when using the oven, follow basic precautions, including the following:

Proper Installation

- This appliance must be properly installed and electrically grounded by a qualified technician. Connect only to properly grounded outlet. See "Grounding Instructions" found in the Installation Instructions.
- This appliance should be serviced only by a qualified service technician. Contact the nearest authorized service center for examination, repair or adjustment.
- Do not repair or replace any part of the oven unless specifically recommended. Refer service to an authorized servicer.
- Do not operate this appliance if it is not working properly or if it has been damaged, until an authorized servicer has examined it.
- Install or locate this appliance only in accordance with the Installation Instructions.
- Use this oven only as intended by the manufacturer. If you have any questions, contact the manufacturer.

IMPORTANT SAFETY INSTRUCTIONS

- Do not cover or block any openings on this appliance.
- Use this appliance only for its intended use as described in this manual. Do not use corrosive chemicals, vapors, or nonfood products in this appliance. This type of oven is specifically designed to heat or cook. It is not designed for industrial or laboratory use. The use of corrosive chemicals in heating or cleaning will damage the appliance.
- Be sure the blower fan runs whenever the oven is in operation. If the fan does not operate, do not use the oven. Call an authorized service center.
- Never use the oven to warm or heat a room.

To reduce the risk of fire in the oven cavity:

- Do not store flammable materials in or near the oven.
- Do not use water on a grease fire. Smother fire or use a dry chemical or foam-type extinguisher.
- It is highly recommended that a fire extinguisher be readily available and highly visible next to any cooking appliance.
- Do not overcook food. Carefully attend oven if paper, plastic or other combustible materials are placed inside the oven.
- Do not use the cavity for storage purposes. Do not leave paper products, cooking utensils or food in the cavity when not being used.
- If materials inside the oven should ignite, keep oven door closed. Turn oven off and disconnect the circuit at the circuit breaker box.
- Do not allow children to use this appliance unless closely supervised by an adult. Children and pets should not be left alone or unattended in the area where the appliance is in use. Never allow children to sit or stand on any part of the oven.
- Do not store items of interest to children above the oven. If children should climb onto the appliance to reach these items, they could be seriously injured.
- For personal safety, wear proper clothing. Loose fitting or garments with hanging sleeves should never be worn while using this appliance.
- Tie long hair so that it doesn't hang loose.
- Do not touch heating elements or interior surfaces of oven.
- The heating elements may be hot even though they are dark in color. Interior surfaces of an oven become hot enough to cause burns.

IMPORTANT SAFETY INSTRUCTIONS

- During and after use, do not touch or let clothing or other flammable materials contact the heating elements or the interior surfaces of the oven until they have had sufficient time to cool.
- The trim on the top and sides of the oven door may become hot enough to cause burns.
- Use care when opening the door. Open the door slightly to let hot air or steam escape before removing or replacing food.
- Do not heat unopened food containers. Build-up of pressure may cause the container to burst and cause injury.
- Always place oven racks in desired location while oven is cool. If a rack must be moved while oven is hot, do not let potholder contact the hot heating elements.
- Use only dry potholders. Moist or damp potholders on hot surfaces may result in burns from steam. Do not let potholder touch hot heating elements. Do not use a towel or other bulky cloth.

Safety for the Self-cleaning Oven:

- Before self-cleaning the oven, remove the broiler pan, oven racks (only when not made of porcelain), other utensils and excess soft spillage.
- Confirm that the door locks and will not open once both selectors are in CLEAN position and the door lock icon appears. If the door does not lock, turn the cook mode selector to OFF and do not run Self-Clean. Call an authorized servicer.
- Do not clean the door gasket. It is essential for a good seal. Care should be taken not to rub, damage, move or remove the door gasket.
- Do not use commercial oven cleaners or oven liner protective coatings of any kind in or around any part of the oven.
- Clean only oven parts listed in this manual.
- Other surfaces of the appliance may become hot enough to cause burns - among these surfaces are for example: oven vent openings and surfaces near these openings, oven doors, and windows of oven doors.

READ AND SAVE THESE INSTRUCTIONS

PARTS AND FEATURES

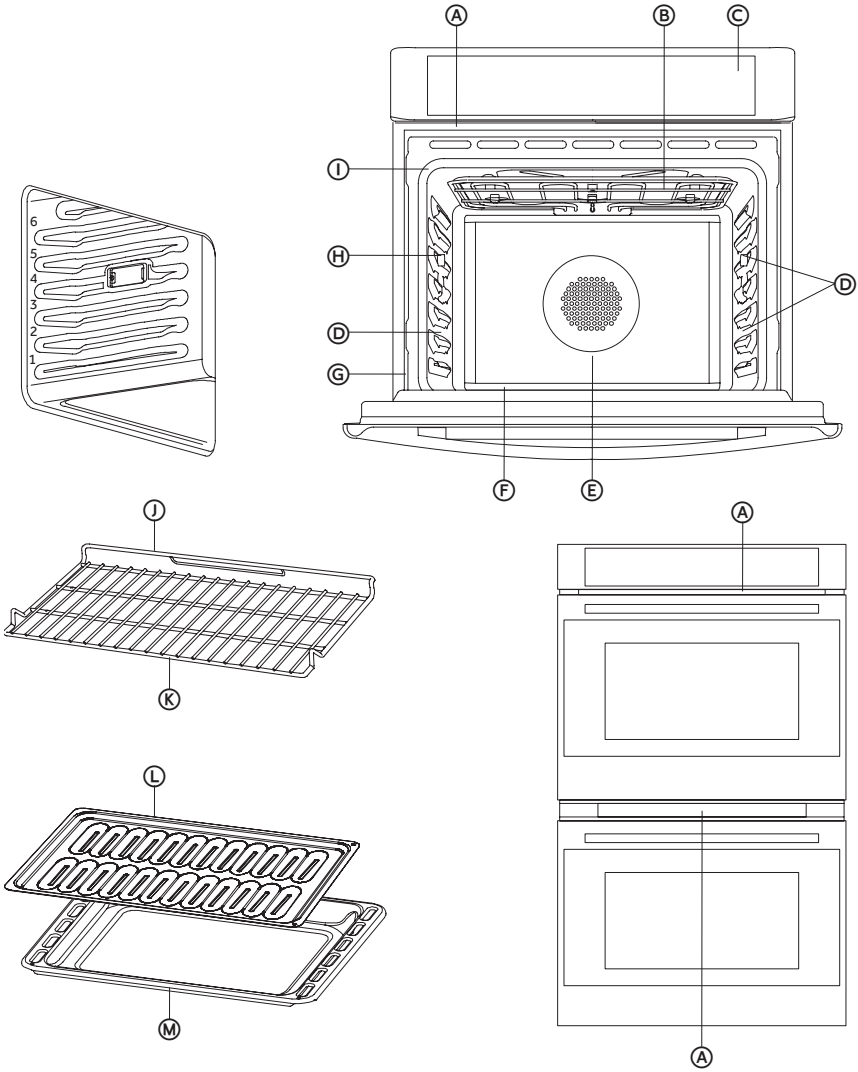

- (A)** Cooling Vents
- (B)** Broil Element
- (C)** Control Panel
- (D)** Halogen Light
- (E)** Convection Fan and Element
- (F)** Bottom Element (not visible)
- (G)** Model and Serial # Plate
- (H)** Temperature Probe (Upper Oven Only)
- (I)** Door Gasket
- (J)** Oven Rack Back
- (K)** Oven Rack Front
- (L)** Broiler Pan Rack
- (M)** Broiler Pan

CONTROL PANEL

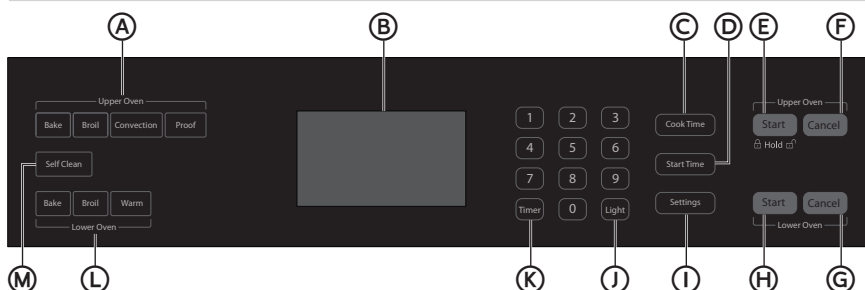

- A** Upper Oven Controls
- B** Display
- C** Cook Time
- D** Start Time
- E** Upper Oven Start
- F** Upper Oven Cancel
- G** Lower Oven Cancel
- H** Lower Oven Start
- I** Settings
- J** Light
- K** Timer
- L** Lower Oven Controls
- M** Self-Clean

OVEN MODE CONTROLS



Depending on which oven you are using, select from Bake, Broil, Convection and Warm/Proof oven modes.

DISPLAY

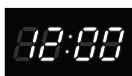

When power is first supplied to the oven or if a power failure occurs, "12:00" will appear on the display.

See "Clock," later in this section, for instructions to set the time-of-day. When the oven is not in use, the time-of-day appears in the display.

START/CONTROL LOCKOUT



START

The Start control begins any oven function. If Start is not pressed within 2 minutes after pressing a keypad the function is canceled and the time-of-day is displayed.

CONTROL PANEL LOCKOUT

The control panel can be locked to avoid unintended use of the oven.

NOTES:

- The control cannot be locked if the oven is in use or if Cook Time is operating.
- The current time-of-day will remain in the display when the control is locked.

To Lock Control Panel:

- Press and hold START for 3 seconds or until "LOCKED" appears in the display. "LOCKED" will remain lit in the display.

To Unlock Control Panel:

- Press and hold START for 3 seconds or until "LOCKED" scrolls in the display.

CANCEL

- Press the Cancel button to stop any function except Timer and Control Panel Lock.

LIGHT

The oven lights turn On automatically when the oven door is opened, and turns Off automatically when the oven door is closed.

- Press the Light button to turn On/Off the oven lights when the oven door is closed.

TIMER

The Timer can be set in hours or minutes up to 11 hours and 59 minutes.

To Set the Timer:

1. Press TIMER.
2. Use the number keypad to enter the length of time in hours and minutes.
3. Press TIMER to begin the countdown. If enabled, timer tone(s) will sound at the end of countdown.
4. Press TIMER to cancel the Timer and return to the time-of-day.

NOTE: Do not press CANCEL because the oven will turn off.

COOK TIME

The Cook Time feature allows the oven to be set to turn on at a certain time of day, cook for a set length of time, and then turn off automatically.

IMPORTANT: You must select an Oven Mode before you can set a Cook Time.

NOTES:

- Cook Time can be set in hours or minutes up to 11 hours and 59 minutes.
- To change the cook time during cooking, press CANCEL. Enter the new cook time and press START.
- At the end of the set cook time, the oven will turn off automatically, the end of cycle tone will sound, and "Cooking Complete" will appear in the text area.

To Set Cook Time:

1. Select cooking mode.
2. Select temperature.
3. Press COOK TIME. Enter the desired cook time by pressing the number keypad.
4. Press START. The oven will begin preheating.

NOTES:

- The Cook Time format is HR:MIN, switching to MIN:SEC during the last minute.
- The alert tone will sound until Cook Time is canceled.

START TIME

Start Time

This feature allows you to set the oven to turn on at a later time.

IMPORTANT: The clock must be set to the correct time-of-day.

1. Select an Oven Mode.
2. Select temperature.
3. Set Cook Time.
4. Press START TIME.
5. Enter the desired Start Time by pressing the number keypad. "Press START" will appear the display. If Cook Time was not set, the control will prompt you to "Set Cook Time."

WARNING

Food Poisoning Hazard

Do not let food sit in oven more than one hour before or after cooking.
Doing so can result in food poisoning or sickness.

6. Place the food in the oven and close the oven door.
7. Press START. Start Time will begin counting down until it reaches the set time-of-day.

NOTE: At the end of Cook Time, the oven will turn off automatically, an alert tone will sound and "Cooking Complete" will appear in the display.

SETTINGS



The Settings control allows you to access the menu for additional functions and features.

Press **SETTINGS** to show Menu Options 1 - 6. Then, press **START** to show Options 7 - 9.

CLOCK

The clock can be set to display time in a 12-hour or 24-hour format. The clock is factory preset for the 12-hour format.

To Set the Clock:

NOTE: Before setting the clock, make sure both the Oven and Timer are turned Off.

1. Press **SETTINGS**. The various Options will appear in the display.
2. Press **1** on the number keypad. "Clock" will appear in the display.
3. Press the number keypad to enter the time-of-day.
4. Press **START** to toggle between AM and PM.
5. Press **SETTINGS** to confirm; time-of-day is set.

To Change the Clock to 24-Hour Format:

1. Press **SETTINGS**. The various Options will appear in the display.
2. Press "**5**" on the number keypad. "12/24 HOUR" and "12" will appear in the display.
3. Press "**1**" on the number keypad to change the 12/24 Hour setting to 24-hour.
4. Press **SETTINGS** to confirm. The 12/24-Hour setting has been changed.

TONES

Tones are audible signals, indicating the following:

Number of Tones	Indicates		
1	Valid Press	Function has been entered	Oven is Preheated
2	Invalid Touch Pad Press		
4	End of Cycle	End of Timer	

To Turn On/Off Sound:

The oven sound is factory preset for On but can be changed to Off.

1. Press **SETTINGS**. The various Options will appear in the display.
2. Press "**3**" on the number keypad. "SOUND" and "ON" will appear in the display.
3. Press "**1**" on the number keypad. "ON/OFF" will appear in the display.
4. Press "**1**" on the number keypad to turn the sound Off.
5. Press **SETTINGS** to confirm. The sound has now been turned off.
6. Press **SETTINGS**, and then follow the display prompts to return the sound setting to On.

To Adjust Sound Volume:

The oven sound is factory preset for High but can be changed to Low.

1. Press **SETTINGS**. The various Options will appear in the display.
2. Press "4" on the number keypad. "SOUND VOLUME" and "HIGH" will appear in the display.
3. Press "1" on the number keypad. "HIGH/LOW" will appear in the display.
4. Press "1" on the number keypad to turn the sound Low.
5. Press **SETTINGS** to confirm. The sound volume has now been changed.
6. Press **SETTINGS**, and then follow the display prompts to return the sound volume setting to High.

DEGREES FAHRENHEIT AND CELSIUS

The control panel is factory preset to display the temperature in degrees Fahrenheit, but can be changed to display in degrees Celsius.

To Change the Display from Degrees Fahrenheit to Degrees Celsius:

1. Press **SETTINGS**. The various Options will appear in the display.
2. Press "2" on the number keypad. "TEMP UNIT" and "FAHRENHEIT" will appear in the display.
3. Press "1" on the number keypad. "DEGREE F/C" will appear in the display.
4. Press "1" on the number keypad to change the temperature unit setting to degrees Celsius.
5. Press **SETTINGS** to confirm. The temperature unit has been changed.
6. Press **SETTINGS**, and then follow the display prompts to return to Fahrenheit.

SABBATH MODE

Sabbath mode is designed for those whose religious observances require disabling certain oven features. By enabling Sabbath Mode, the oven will conform to Star-K Jewish Sabbath requirements.

NOTE: The oven is factory preset with Sabbath Mode Off.

To Turn On/Off Sabbath Mode:

1. Make sure the oven is turned Off, and the meat probe is not plugged in.

NOTE: Sabbath mode cannot be set when the oven is On. The oven will not recognize the meat probe while in Sabbath mode.

2. Press **SETTINGS** > Press **START** > Press 7, and then press 1 to (toggle between ON / OFF).
3. Press **SETTINGS** again to enable Sabbath mode. The only cooking function that works while the oven is set to Sabbath mode is Bake.

To Bake While the Oven is in Sabbath Mode:

1. Press and hold **BAKE** for 3 seconds.
2. Enter the desired oven temperature by pressing the numbered keypad.
3. After selecting Bake and a Temperature, you have the option to set a Cook Time and Start Time before pressing **START**. See "Cook Time" and "Start Time."
4. Press **START**. Pressing Start activates Sabbath mode.

Only the Cancel control is functional.

- Press CANCEL twice to exit Sabbath mode, and resume normal oven operation. The display will return to the time-of-day.

NOTE: If there is a power failure while the oven is in Sabbath mode, the oven will exit Sabbath mode and resume in normal mode when power is restored.

LANGUAGE

The Language is factory preset to English but it can be changed to French.

To Change the Language from English to French:

1. Press SETTINGS. The various Options will appear in the display.
2. Press "6" on the number keypad. "LANGUAGE, ENGLISH1, and FRENCH 2" will appear in the display.
3. Press "2" on the number keypad to select French.
4. Press SETTINGS, and then follow the display prompts to return the Language setting to English.

SELF-CLEAN

Controls the Automatic Self-cleaning feature. See "Oven Care."

OVEN USE

BEFORE USING THE OVEN

1. Turn the Temperature Control to the highest setting.
2. Turn the Cooking Mode Selection control to a cooking mode.
3. Allow the oven to operate for 30 minutes with the door closed and no food in the cavity.
4. Turn off the oven, and allow the oven to cool.

NOTE: Any odor that may be detected during this initial use is due to the evaporation of substances used to protect the oven during storage.

GENERAL

IMPORTANT: Do not place anything, including dishes, foil and oven trays, on the bottom of the oven when it is in operation to avoid damaging the enamel.

1. Place bake ware with food on one or both of the shelves provided with the oven.
2. Press the Oven Mode control for the desired oven function.
3. Use the number keypad to enter the oven temperature.
4. Press START.

PREHEATING THE OVEN

- Preheat the oven when using the Bake, Convection Bake and Convection Roast modes.
- Selecting a higher temperature does not shorten the preheat time.

- Preheating is necessary for good results when baking cakes, cookies, pastry and breads.
- Preheating will help to sear roasts and seal in meat juices.
- Place oven racks in their proper position before preheating.
- During preheating, the selected cooking temperature is always displayed.
- A beep will confirm that the oven is preheated and the "PREHEAT" writing will turn off.

OPERATIONAL SUGGESTIONS

- Use the cooking charts, in this manual, as a guide.
- Do not set pans on the open oven door.
- Use the interior oven lights to view the food through the oven door window rather than opening the door frequently.

TEMPERATURE PROBE

WARNING



Burn Hazard

Use an oven mitt to remove temperature probe.

Do not touch broil element.

Failure to do so can result in burns.

The temperature probe monitors the internal food temperature, which is frequently used as an indicator of doneness especially for meats and poultry, and turns off the oven when the internal food temperature reaches the programmed temperature. The temperature probe will work with all oven modes except for the Warm/Proof, Sabbath and Self-Clean modes.

IMPORTANT: Always unplug and remove the temperature probe from the oven when removing the food.

To Use the Temperature Probe:

1. Insert the probe into the food.

NOTE: For meats, the probe tip should be inserted into the center of the thickest part of the meat. Make sure that the probe tip is not into the fat or touching bone.

2. Place the food into the oven. Keeping the temperature probe as far away from a heat source as possible, plug the temperature probe into the oven outlet. Close the oven door.
3. Select the oven mode.
4. Enter the oven temperature by pressing the numbers on the keypad.

5. Press START. The set oven temperature will appear on the display throughout cooking.
6. Enter the desired internal food temperature by pressing the numbers on the keypad, and then press START.

NOTES:

- The internal food temperature can be set between 110°F and 200°F (43°C and 93°C).
 - When the set probe temperature is reached, the oven will turn off.
7. Press CANCEL when finished. Unplug the temperature probe and remove food from the oven.

NOTE: The probe icon will remain lit in the display until the probe is unplugged.

UTENSILS

- Glass baking dishes absorb heat. Reduce oven temperature 25°F (15°C) when baking in glass.
- Use pans that produce the desired browning. The type of finish on the pan will help determine the amount of browning that will occur.
 - Shiny, smooth metal or light non-stick / anodized pans reflect heat, resulting in lighter, more delicate browning. Cakes and cookies require this type of utensil.
 - Dark, rough or dull pans will absorb heat resulting in a browner, crisper crust. Use this type for pies.
- Do not cook with the empty broiler pan in the oven, as this could affect cooking performance. Store the broil pan outside of the oven.

HIGH ALTITUDE BAKING

When cooking at high altitude, cooking times may be extended.

OVEN RACKS

IMPORTANT: To avoid permanent damage to the porcelain finish, place food or bakeware on an oven rack. Do not place food or bakeware directly onto the oven door or oven bottom.

- The oven shelves can be placed in any of the five height positions with the oven.
- Position racks before turning on the oven.
- Make sure each shelf is inserted between two wire supports that are the closest together.
- Make sure the oven racks are level.
- Oven shelves have a stop to keep them from being unintentionally withdrawn fully.

To Remove Oven Racks:

- Pull rack out to the stop position, raise the front edge, and then lift out.

To Replace Oven Racks:

- Place oven rack on the wire supports along the sides of the oven. Tilt the front edge up slightly, and slide rack to the rear until it clears the stop position. Lower the front and slide the rack into the oven.

OVEN DOOR

To avoid oven door glass breakage:

- Do not close the oven door if the racks are not fully inserted into the oven cavity or if bakeware extends past the front edge of an oven rack.
- Do not set objects on the glass surface of the oven door.
- Do not hit glass surfaces with bakeware or other objects.
- Do not wipe down glass surfaces until the oven has completely cooled.

OVEN VENTS

Blocking or covering the oven vents will cause poor air circulation, affecting cooking, cleaning and cooling results.

- Both the upper and lower oven vent(s) allow fresh air to enter the cooling system.
- The lower oven vent also allows hot air to be expelled from the cooling system.

COMPONENT COOLING FAN

Activates during any cooking or self-cleaning mode to cool inner components and outer door surfaces. This air is exhausted through the vent located above the oven door. It continues to run until components have cooled sufficiently. The cooling fan operates at double speed (or RPM's) in self-clean and whenever the internal components temperature becomes high.

OVEN CONDENSATION AND TEMPERATURE

- It is normal for a certain amount of moisture to evaporate from the food during any cooking process. The amount depends on the moisture content of the food.
- The moisture may condense on any surface cooler than the inside of the oven, such as the control panel.
- Your new oven has an electronic temperature sensor to help maintain an accurate temperature. Your previous oven may have had a mechanical thermostat that drifted gradually over time to a higher temperature. It is normal that you may need to adjust your favorite recipes when cooking in a new oven.

OVEN TEMPERATURE CONTROL

The oven provides accurate temperatures; however, it may cook faster or slower than your previous oven, so the temperature calibration can be adjusted. It can be adjusted in degrees Fahrenheit or Celsius.

A minus sign means the oven will be cooler by the displayed amount. The absence of a minus sign means the oven will be warmer by the displayed amount.

Use the following chart as a guide:

ADJUSTMENT °F (ADJUSTMENT °C)	COOKS FOOD
10°F (6°C)	a little more
20°F (12°C)	moderately more
30°F (17°C)	much more
-10°F (-6°C)	a little less
-20°F (-12°C)	moderately less
-30°F (-17°C)	much less

To Adjust Oven Temperature Calibration:

1. Press **SETTINGS**. The various Options will appear in the display.
2. Press number 9 on the keypad. "CALIBRATION" "PRESS 3 TO INCREASE/PRESS 6 TO DECREASE" will scroll across the display.
3. Press number 3 on the keypad to increase or number 6 to decrease the temperature in 5°F (3°C) increments. The adjustment can be set between 30°F (18°C) and -30°F (-18°C).
4. Press **SETTINGS** to save the adjustment, and then exit the Temperature Calibration menu.

OVEN MODES

The illustrations show the heating elements and fans used for each oven mode.

BAKE

Baking is cooking with heated air. Both upper and lower elements in the oven are used to heat the air but no fan is used to circulate the heat.

Follow the recipe or convenience food directions for baking temperature, time and rack position. Baking time will vary with the temperature of ingredients and the size, shape and finish of the bakeware.

1. Press **BAKE** to select the bake mode. "BAKE" will appear in the display and 350°F (177°C) will be displayed. "Set temp or Press START" will appear in the display.
2. Press **START**, if you wish to bake at 350°F (177°C).

OR

Enter the desired temperature by pressing the number keypad, and then press **START**. The temperature can be set from 170°F (77°C) to 500°F (260°C).

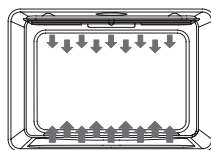

NOTES:

- The temperature can be changed at any time during cooking. Press **CANCEL** to clear the settings. Select oven mode, then enter the desired temperature by pressing the number keypad, and then press **START**.
 - After selecting an Oven Mode and Temperature, you have the option to set a Cook Time and Start Time before pressing **START**. See "Cook Time" and "Start Time."
3. Press **CANCEL** when finished baking, and remove food from the oven.

BROIL

Broiling uses direct radiant heat to cook food. The lower the temperature, the slower the cooking. Thicker cuts and unevenly shaped pieces of meat, fish and poultry may cook better at lower broiling temperatures.

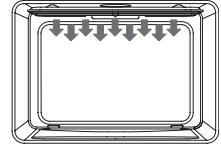

- For best results, use a broiler pan and rack (not provided). It is designed to drain juices and help avoid spatter and smoke.
- For proper draining, do not cover the grid with foil. The bottom of the pan may be lined with aluminum foil for easier cleaning.
- Trim excess fat to reduce spattering. Slit the remaining fat on the edges to avoid curling.
- Select HI/550°F (288°C) broil for most broiling. Select LO/450°F (232°C) broil for low-temperature broiling of longer cooking foods such as poultry to avoid over browning.
- Pull out oven rack to stop position before turning or removing food. Use tongs to turn food to avoid the loss of juices. Very thin cuts of fish, poultry or meat may not need to be turned.

To Broil:

1. Place the food on the rack in the broiler pan and place pan in the oven. Close the oven door.

NOTE: Preheating is not necessary.

2. Press BROIL for the desired oven. "BROIL" and "Set temp or Press START" will appear in the display, and "550°F" (288°C) will be displayed.
3. Press START, if you wish to broil at 550°F (288°C).

OR

Enter the desired temperature by pressing the number keypad, and then press START. The temperature can be set from 450°F (232°C) to 550°F (288°C).

4. "BROIL" will appear in the display after Start is pressed.

NOTES:

- The temperature can be changed at any time during cooking. Press CANCEL to clear the settings. Select oven mode, then enter the desired temperature by pressing the number keypad, and then press START.
 - After selecting an Oven Mode and Temperature, you have the option to set a Cook Time and Start Time before pressing START. See "Cook Time" and "Start Time."
5. Press CANCEL when finished broiling, and remove food from the oven.

WARM (LOWER OVEN)

The Warm mode keeps hot, cooked foods at serving temperature.

⚠ WARNING

Food Poisoning Hazard

Do not let food sit in oven more than one hour before or after cooking.
Doing so can result in food poisoning or sickness.

IMPORTANT: Food must be at serving temperature before placing it in the warmed oven. Food may be held up to 1 hour; however, breads and casseroles may become too dry if left in the oven during the Warm function. For best results, cover food.

1. Press WARM keypad. "WARM" and "Set Temp or Press START" and 170°F (78°C) will be displayed.
2. Use the number keypad to enter the desired temperature. The temperature can be set from 140°F (60°C) to 210°F (99°C).
3. Press START. "WARM" and the set temperature will appear in the display.
4. Place food in the oven and close the door.
5. Press CANCEL when finished, and remove food from the oven.

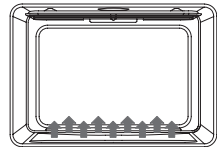

To Cancel Warm Feature:

- Press CANCEL. Remove food from oven.

PROOF (UPPER OVEN)

The Proof mode prepares dough for baking by activating the yeast. Follow the recipe directions as a guide.

⚠ WARNING

Food Poisoning Hazard

Do not let food sit in oven more than one hour before or after cooking.
Doing so can result in food poisoning or sickness.

1. Before proofing, place the dough in a lightly greased bowl and cover loosely with wax paper, coated with shortening. Place on second rack from the bottom and close the oven door.
2. Press PROOF. "PROOF" and "Set Temp or Press START," and 100°F (38°C) will be displayed.
3. Use the number keypad to enter the desired temperature. The temperature can be set from 80°F (27°C) to 120°F (49°C).
4. Press START.

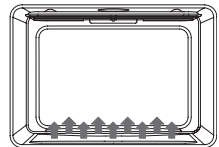

5. Let the dough rise until nearly doubled in size, checking after 20-25 minutes. Proofing time may vary depending on dough type and quantity.
6. Press CANCEL when finished proofing.
7. Before second proofing, shape the dough, place it in baking pan(s) and cover loosely with plastic wrap, coated with cooking spray. Follow the same placement and control steps above. Before baking, remove the plastic wrap.

CONVECTION (UPPER OVEN ONLY)

During convection cooking, the fan provides hot air circulation throughout the oven. The movement of heated air around the food can help to speed up cooking by penetrating the cooler outer surfaces.

In Convection mode, the ring element, bake and broil elements, and the fan operate to heat the oven cavity. If the oven door is opened during convection cooking or preheating, the fan turns off immediately and the element(s) will turn off after 30 seconds. Once the door is closed, the element(s) will turn back on.

CONVECTION FAN

The convection fan operates during any convection mode. When the oven is operating in convection mode, the fan will turn off automatically when the door is opened. The convection fan always runs during the preheat time.

ADVANTAGES OF CONVECTION COOKING

- Saves time and energy.
- Even baking, browning and crisping are achieved.
- During roasting, juices and flavors are sealed in while the exterior is crisp.
- Yeast breads are lighter, more evenly textured, more golden and crustier.
- Air-leavened foods such as cream puffs, soufflés and meringues are higher and lighter.
- Baking on multiple racks at the same time with even results is possible.
- Prepare whole meals at once with no flavor transfer.
- Dehydrates herbs, fruits and vegetables.
- Requires no specialized bakeware.
- Convection broiling allows for extraordinary grilling with thicker cuts of food.

CONVECTION BAKE

Use Convection bake for single or multiple rack baking. When convection baking, reduce your recipe baking temperature by 25°F (15°C).

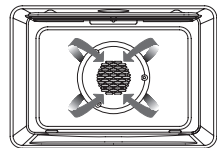

To Set Convection Bake:

1. Press CONVECTION once. "Convection" and "Press 1-3 To Choose" will appear in the display.
2. Press 1. CONVECT BAKE on the menu screen. "Set Temp or Press START" and 325°F (162°C) will be displayed.
3. Press START If you wish to convection bake at 325°F (162°C).

OR

Enter the desired temperature by pressing the number keypad, and then press START. The temperature can be set from 170°F (77°C) to 500°F(260°C).

NOTE: After selecting an Oven Mode and Temperature, you have the option to set a Cook Time and Start Time before pressing START. See "Cook Time" and "Start Time."

4. The oven will begin preheating once Start is pressed. A tone will sound when the oven is at the set temperature.
5. Place the food in the oven and close the oven door when preheat is completed.
6. Press CANCEL when finished, and remove food from the oven.

CONVECTION BROIL

When convection broiling, enter your normal broiling temperature. The oven door must be closed when using Convection Broil.

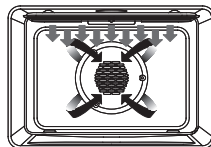

It is not necessary to preheat the oven for Convection Broil.

1. Place the food in the oven and close the oven door.
2. Press CONVECTION once. "Convection" and "Press 1-3 To Choose" will be displayed.
3. Press 2. CONVECT BROIL on the menu screen. "Set Temp or Press Start" and 450°F (232°C) will be displayed.
4. Press START, if you wish to broil at 450°F (232°C).

OR

Enter the desired temperature by pressing the number keypad, and then press START. The temperature can be set from 170°F(77°C) to 550°F(288°C).

NOTE: After selecting an Oven Mode and Temperature, you have the option to set a Cook Time and Start Time before pressing START. See "Cook Time" and "Start Time."

5. "Convect Broil" will be displayed, once Start is pressed.
6. Press CANCEL when finished, and remove food from the oven.

CONVECTION ROAST

When Convection roasting, enter your normal roasting temperature. The roasting time should be 15-30% less than in conventional cooking. It is not necessary to preheat the oven for convection roast.

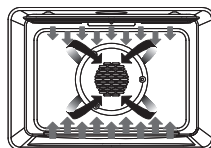

1. Place the food in the oven and close the oven door.
2. Press CONVECTION once. "Convection" and "Press 1-3 To Choose" will be displayed.
3. Press 3. CONVECT ROAST on the menu screen. "Set Temp or Press Start", and 325°F (163°C) will be displayed.
4. Press START, if you wish to convection roast at 325°F (163°C).

OR

Enter the desired temperature by pressing the number keypad, and then press START. The temperature can be set from 170°F (77°C) to 500°F (260°C).

NOTE: After selecting an Oven Mode and Temperature, you have the option to set a Cook Time and Start Time before pressing START. See "Cook Time" and "Start Time."

5. "Convect Roast" will be displayed, once Start is pressed.
6. Press CANCEL when finished and remove food from the oven.

BAKE TIPS

- For best results, bake food on a single rack with at least 1" - 1 ½" (2,5 - 3cm) space between utensils and oven walls.
- Use one rack when selecting the bake mode.
- Check for doneness at the minimum time.
- Use metal bake ware (with or without a non stick finish), heatproof glass, glass-ceramic, pottery or other utensils suitable for the oven.
- When using heatproof glass, reduce temperature by 25°F (15°C) from recommended temperature.
- Use baking sheets with or without sides or jelly roll pans.
- Dark metal pans or nonstick coatings will cook faster with more browning. Insulated bake ware will slightly lengthen the cooking time for most foods.
- Do not use aluminum foil or disposable aluminum trays to line any part of the oven. Foil is an excellent heat insulator and heat will be trapped beneath it. This will alter the cooking performance and can damage the finish of the oven.
- Avoid using the opened door as a shelf to place pans.
- See Troubleshooting for tips to Solving Baking and Roasting Problems.

BAKE CHART

FOOD ITEM	RACK POSITION	TEMP. °F (°C) (PREHEATED OVEN)	TIME (MIN)
Cake			
Cupcakes	2	350 (175)	19-22
Bundt Cake	1	350 (175)	40-45
Angel Food	1	350 (175)	35-39
Pie			
2 crust, fresh, 9"	2	375-400 (190-205)	45-50
2 crust, frozen fruit, 9"	2	375 (190)	68-78
Cookies			
Sugar	2	350-375 (175-190)	8-10
Chocolate Chip	2	350-375 (175-190)	8-13
Brownies	2	350 (175)	29-36
Breads			
Yeast bread loaf, 9x5	2	375 (190)	18-22
Yeast rolls	2	375-400 (190-205)	12-15
Biscuits	2	375-400 (190-205)	7-9
Muffins	2	425 (220)	15-19
Pizza			
Frozen	2	400-450 (205-235)	23-26
Fresh	2	475 (246)	15-18

CONVECTION BAKE TIPS

Reduce recipe baking temperatures by 25°F (15°C).

- For best results, foods should be cooked uncovered, in low-sided pans to take advantage of the forced air circulation. Use shiny aluminum pans for best results unless otherwise specified.
- Heatproof glass or ceramic can be used. Reduce temperature by another 25°F (15°C) when using heatproof glass dishes for a total reduction of 50°F (30°C).
- Dark metal pans may be used. Note that food may brown faster when using dark metal bake ware.
- The number of racks used is determined by the height of the food to be cooked.
- Baked items, for the most part, cook extremely well in convection. Don't try to convert recipes such as custards, quiches, pumpkin pie, or cheesecakes, which do not benefit from the convection-heating process. Use the regular Bake mode for these foods.

- Multiple rack cooking for oven meals is done on rack positions 1, 2, 3, 4 and 5. All five racks can be used for cookies, biscuits and appetizers.

- 2 Rack baking: Use positions 1 and 3.

- When baking four cake layers at the same time, stagger pans so that one pan is not directly above another. For best results, place cakes on front of upper rack and back of lower rack (See graphic at right). Allow 1" - 1 ½" (2,5 - 3 cm) air space around pans.

- Converting your own recipe can be easy. Choose a recipe that will work well in convection.
- Reduce the temperature and cooking time if necessary. It may take some trial and error to achieve a perfect result. Keep track of your technique for the next time you want to prepare the recipe using convection.

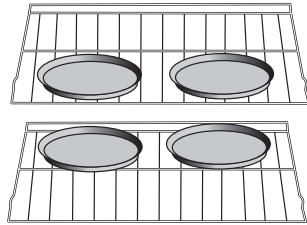
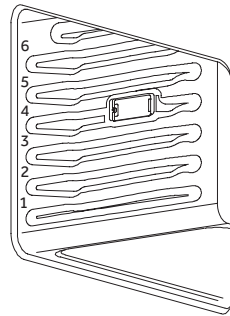

- See Troubleshooting for tips to Solving Baking and Roasting Problems.

FOODS RECOMMENDED FOR CONVECTION BAKE MODE:

Appetizers, Biscuits, Coffee Cakes
 Cookies (2 to 4 racks), Yeast Breads
 Cream Puffs, Popovers
 Casseroles and One-Dish Entrees
 Oven Meals (rack positions 1, 2, 3)
 Air Leavened Foods (Soufflés, Meringue, Meringue-Topped Desserts, Angel Food Cakes, Chiffon Cakes)

CONVECTION BAKE CHART

Reduce standard recipe temperature by 25 °F (15 °C) for Convection Bake. Temperatures have been reduced in this chart.

FOOD ITEM	RACK POSITION	TEMP. °F (°C) (PREHEATED OVEN)	TIME (MIN)
Cake			
Cupcakes	2	325 (160)	20-22
Bundt Cake	1	325 (160)	43-50
Angel Food	1	325 (160)	43-47
Pie			
2 crust, fresh, 9"	2	350-400 (175-205)	40-52
2 crust, frozen fruit, 9"	2	350 (175)	68-78
Cookies			
Sugar	2	325-350 (160-175)	9-12
Chocolate Chip	2	325-350 (160-175)	8-13
Brownies	2	325 (160)	29-36
Breads			
Yeast bread loaf, 9x5	2	350 (175)	18-22
Yeast rolls	2	350-375 (175-190)	12-15
Biscuits	2	375 (190)	8-10
Muffins	2	400 (205)	17-21
Pizza			
Frozen	2	375-425 (190-220)	23-26
Fresh	2	450 (232)	15-18

CONVECTION ROAST TIPS

- Do not preheat for Convection Roast.
- Roast in a low-sided, uncovered pan.
- When roasting whole chickens or turkey, tuck wings behind back and loosely tie legs with kitchen string.
- Use the 2-piece broil pan for roasting uncovered.

WARNING



Burn Hazard

Use an oven mitt to remove temperature probe.

Do not touch broil element.

Failure to do so can result in burns.

- Use the probe or a meat thermometer to determine the internal doneness on “END” temperature (see cooking chart).
- Double-check the internal temperature of meat or poultry by inserting meat thermometer into another position.
- Large birds may also need to be covered with foil (and pan roasted) during a portion of the roasting time to prevent over-browning.
- The minimum safe temperature for stuffing in poultry is 165°F (75°C).
- After removing the item from the oven, cover loosely with foil for 10 to 15 minutes before carving if necessary to increase the final foodstuff temperature by 5° to 10°F (3° to 6° C).

CONVECTION ROAST CHART

MEATS	WEIGHT (lb)	OVEN TEMP. °F (°C)	RACK POSITION	TIME (min. per lb)	INTERNAL TEMP. °F (°C)
Beef					
Rib Roast	4-6	325 (160)	2	16-20 18-22	145 (63) medium rare 160 (71) medium
Rib Eye Roast, (boneless)	4-6	325 (160)	2	16-20 18-22	145 (63) medium rare 160 (71) medium
Rump, Eye, Tip, Sirloin (boneless)	3-6	325 (160)	2	16-20 18-22	145 (63) medium rare 160 (71) medium
Tenderloin Roast	2-3	400 (205)	2	15-20	145 (63) medium rare
Pork					
Loin Roast (boneless or bone-in)	5-8	350 (175)	2	16-20	160 (71) medium
Shoulder	3-6	350 (175)	2	20-25	160 (71) medium
Poultry					
Chicken whole	3-4	375 (190)	2	18-21	180 (82)
Turkey, not stuffed	12-15	325 (160)	1	10-14	180 (82)
Turkey, not stuffed	16-20	325 (160)	1	9-11	180 (82)
Turkey, not stuffed	21-25	325 (160)	1	6-10	180 (82)
Turkey Breast	3-8	325 (160)	1	15-20	170 (77)
Comish Hen	1-1 ½	350 (175)	2	45-75 total	180 (82)
Lamb					
Half Leg	3-4	325 (160)	2	22-27 28-33	160 (71) medium 170 (77) well
Whole Leg	6-8	325 (160)	1	22-27 28-33	160 (71) medium 170 (77) well

CONVECTION BROIL TIPS

- Place rack in the required position needed before turning on the oven.
- Use Convection Broil mode with the oven door closed.
- Do not preheat oven.
- Use the 2-piece broil pan.
- Turn meats once halfway through the cooking time (see convection broil chart).

CONVECTION BROIL CHART

FOOD AND THICKNESS	RACK POSITION	BROIL SETTING °F (°C)	INTERNAL TEMP. °F (°C)	TIME SIDE 1 (MIN.)*	TIME SIDE 2 (MIN.)*
Beef					
Steak (1½" or more)					
Medium rare	4	450 (235)	145 (65)	9-12	8-10
Medium	4	450 (235)	160 (71)	11-13	10-12
Well	4	450 (235)	170 (77)	18-20	16-17
Hamburgers (more than 1")					
Medium	4	550 (290)	160 (71)	8-11	5-7
Well	4	550 (290)	170 (77)	11-13	8-10
Poultry					
Chicken Quarters	4	450 (235)	180 (82)	16-18	10-13
Chicken Halves	3	450 (235)	180 (82)	25-27	15-18
Chicken Breasts	4	450 (235)	170 (77)	13-15	9-13
Pork					
Pork Chops (1¼" or more)	4	450 (235)	160 (71)	12-14	11-13
Sausage - fresh	4	450 (235)	160 (71)	4-6	3-5

DEHYDRATE TIPS

The circulating heated air at a lower temperature slowly removes the moisture for food preservation.

- Oven temperature for dehydrating is between 120°F (50°C) to 160°F (70°C).
- Multiple racks can be used simultaneously.
- Some foods require as much as 14-15 hours of time to fully dehydrate.
- Consult a food preservation book for specific times and the handling of various foods.
- Dehydrating is suitable for a variety of fruits, vegetables, herbs and meat strips.
- Drying screens can be purchased at specialty kitchen shops.
- By using paper towels, some food moisture can be absorbed before dehydrating begins (such as with sliced tomatoes or sliced peaches).

DEHYDRATE CHART

FOOD	PREPARATION	APPROXIMATE DRYING TIME* (hrs)	TEST FOR DONENESS
Fruit			
Apples	Dipped in ¼ cup lemon juice and 2 cups water, ¼ slices	11-15	Slightly pliable
Bananas	Dipped in ¼ cup lemon juice and 2 cups water, ¼ slices	11-15	Slightly pliable
Cherries	Wash and towel dry. For fresh cherries, remove pits	10-15	Pliable, leathery, chewy
Oranges Peels and slices	¼ slices of orange; orange part of skin thinly peeled from oranges	Peels 2-4 Slices: 12-16	Orange peel: dry and brittle Orange slices: skins are dry and brittle, fruit is slightly moist
Pineapple rings	Towel dried	Canned: 9-13 Fresh: 8-12	Soft and pliable
Strawberries	Wash and towel dry. Sliced ½" thick, skin (outside) down on rack	12-17	Dry, brittle
Vegetable			
Peppers	Wash and towel dry. Remove membrane of pepper, coarsely chopped about 1" pieces	16-20	Leathery with no moisture inside
Mushrooms	Wash and towel dry. Cut of stem end. Cut into ⅛" slices	7-12	Tough and leathery, dry
Tomatoes	Wash and towel dry. Cut this slices, ⅛" thick, dry well	16-23	Dry, brick red color
Herbs			
Oregano, sage parsley and thyme, and fennel	Rinse and dry with paper towel	Dry at 120°F (60°C) 3-5 hrs	Crisp and brittle
Basil	Place basil leaves 3 to 4" from top. Spray with water, shake off moisture and pat dry	Dry at 120°F (60°C) 3-5 hrs	Crisp and brittle

BROIL TIPS

- Place rack in the required position needed before turning on the oven.
- Use Broil mode with the oven door closed.
- Preheat oven for 5 minutes before use.
- Use the 2-piece broil pan.
- Turn meats once halfway through the cooking time (see convection broil chart).

BROIL CHART

FOOD AND THICKNESS	RACK POSITION	BROIL SETTING °F (°C)	INTERNAL TEMP. °F (°C)	TIME SIDE 1 (MIN.)*	TIME SIDE 2 (MIN.)*
Beef					
Steak (¾"-1")					
Medium rare	5	5	145 (65)	5-7	4-6
Medium	5	5	160 (71)	6-8	5-7
Well	5	5	170 (77)	8-10	7-9
Hamburgers (¾"-1")					
Medium	4	5	160 (71)	8-11	6-9
Well	4	5	170 (77)	10-13	8-10
Poultry					
Breast (bone-in)	4	4	170 (77)	10-12	8-10
Thigh (very well done)	4	3	180 (82)	28-30	13-15
Pork					
Pork Chops (1")	5	5	160 (71)	7-9	5-7
Sausage - fresh	5	5	160 (71)	5-7	3-5
Ham Slice (½")	5	5	160 (71)	4-6	3-5
Seafood					
Fish Filets, 1" Buttered	4	4	Cook until opaque & flakes easily with fork	10-14	Do not turn
Lamb					
Chops (1")					
Medium Rare	5	5	145 (63)	5-7	4-6
Medium	5	5	160 (71)	6-8	4-6
Well	5	5	170 (77)	7-9	5-7
Bread					
Garlic Bread, 1" slices	4	5		2-2,30	
Garlic Bread, 1" slices	3	5		4-6	

* Broiling and convection broiling times are approximate and may vary slightly. Cooking times are indicative and also depend on the thickness and the starting temperature of the meat before cooking.

FOOD SERVICE TEMPERATURE GUIDELINES FROM FSIS (USDA FOOD SAFETY & INSPECTION SERVICE)

140°F (60°C)	Ham, precooked (to Reheat)	165°F (74°C)	Stuffing (cooked alone or in bird)
145°F (63°C)	Fresh beef, Veal, Lamb (medium rare)		Leftovers & Casseroles
160°F (71°C)	Ground Meat & Meat mixtures (Beef, Pork, Veal Lamb)	170°F (77°C)	Fresh beef, Veal, Lamb (well done)
	Fresh beef, Veal, Lamb (medium)		Poultry breast
	Fresh Pork (medium)		Fresh Pork (well done)
	Fresh Ham (raw)	180°F (82°C)	Chicken and Turkey (Whole)
	Egg Dishes		Poultry (thighs and wings)
	Ground Meat & Meat mixtures (Turkey, Chicken)		Duck and Goose

NOTE: Eggs (alone, not used in a recipe) – cook until yolk & white are firm.

Meat Thermometer

On models without a temperature probe, use a meat thermometer to determine whether meat, poultry and fish are cooked to the desired degree of doneness. The internal temperature, not appearance, should be used to determine doneness.

PART		CLEANING METHOD		PART		CLEANING METHOD	
		BLACK & WHITE OVEN	STAINLESS STEEL OVEN			BLACK & WHITE OVEN	STAINLESS STEEL OVEN
1	Door Frame	E	E	10	Mesh Gasket	B	B
2	Interior Door Windows	F	F	11	Interior Oven Door	E	E
3	Removable Oven Racks	A or E	A or E	12	Door Handle	D	D
4	Side Trim	D	D	13	Door Cooling Vent	E	E
5	Control Panel Trim	C	C	14	Door Front	C & D	G
6	Control Panel	C	C	15	Oven Trim	D	D
7	Oven Cooling Vents	D	D	16	End Caps	D	D
8	Oven Front Frame	E	E	17	Broil Pan Rack	E	E
9	Oven Cavity	E	E	18	Broil pan Bottom	E	E

OVEN FINISHES / CLEANING METHODS

The entire oven can be safely cleaned with a soapy sponge, rinsed and dried. If stubborn soil remains, follow the recommended cleaning methods below.

- Always use the mildest cleaner that will do the job.
- Rub metal finishes in the direction of the grain.
- Use clean, soft cloths, sponges or paper towels.
- Rinse thoroughly with a minimum of water so it does not drip into door slots.
- Dry to avoid water marks.

The cleaners listed below indicate types of products to use and are not being endorsed. Use all products according to package directions.

Part	Cleaning Method
A Chrome Plated	<p>Wash with hot sudsy water. Rinse thoroughly and dry. Or, gently rub with Soft Scrub[®], Bon-Ami[®], Comet[®], Ajax[®], Brillo[®] or S.O.S.[®] pads as directed.</p> <p>Easy Off[®] or Dow[®] Oven Cleaners (cold oven formula) can be used, but may cause darkening and discoloration.</p> <p>Racks may be cleaned in the oven during the Self-Cleaning mode. However, chromed racks will lose their shiny finish and permanently change to a metallic gray.</p>
B Fiberglass Knit	DO NOT HAND CLEAN GASKET.
C Glass	Spray Windex [®] or Glass Plus [®] onto a cloth first, then wipe to clean. Use Fantastik [®] or Formula 409 [®] to remove grease spatters.
D Painted	Clean with hot sudsy water or apply Fantastik [®] or Formula 409 [®] first to a clean sponge or paper towel and wipe clean. Avoid using powdered cleansers and steel wool pads.
E Porcelain	Immediately wipe up acidic spills like fruit juice, milk and tomatoes with a dry towel. Do not use a moistened sponge/towel on hot porcelain. When cool, clean with hot sudsy water or apply Bon-Ami [®] or Soft Scrub [®] to a damp sponge. Rinse and dry. For stubborn stains, gently use Brillo [®] or S.O.S. [®] pads. It is normal for porcelain to craze (fine lines) with age due to exposure from heat and food soil.
F Reflective Glass	Clean with hot sudsy water and sponge or plastic scrubber. Rub stubborn stains with vinegar, Windex [®] , ammonia or Bon-Ami [®] DO NOT USE HARSH ABRASIVES.
G Stainless	Always wipe or rub with grain. Clean with a soapy sponge then rinse and dry. Or, wipe with Fantastik [®] or Formula 409 [®] sprayed onto a paper towel. Protect and polish with Stainless Steel Magic [®] and a soft cloth. Remove water spots with a cloth dampened with white vinegar. Use Zud [®] , Cameo [®] , Bar Keeper's Friend [®] or RevereWare Stainless Steel Cleaner [®] , to remove heat discoloration.
H Probe (if present)	Clean probe by hand with detergent and hot water. Then rinse and dry. Do not soak or clean in dishwasher.

AUTOMATIC SELF-CLEANING

WARNING



Burn Hazard

Do not touch the oven during the Self-Cleaning cycle.

Keep children away from oven during Self-Cleaning cycle.

Failure to do so can result in burns.

This oven features a self-cleaning function that eliminates the need to manually scrub the oven interior. During self-cleaning, the oven uses very high temperatures, burning soil to a powdery ash.

IMPORTANT: The health of some birds is extremely sensitive to the fumes given off during the Self-Cleaning cycle. Exposure to the fumes may result in death to certain birds. Always move birds to another closed and well-ventilated room.

- Only one oven at a time can be set to Self-Clean.
- It is common to see smoke and/or an occasional flame-up during the Self-Clean cycle, depending on the content and amount of soil remaining in the oven. If a flame persists, turn off the oven and allow it to cool before opening the door to wipe up the excessive food soil.
- The door latch is automatically activated after selecting the Self-Clean cycle. "AUTO LOCK" will appear in the display. This ensures that the oven door cannot be opened while the oven interior is at clean temperatures.
- The oven light does not operate during Clean mode.
- During Self-Clean, the kitchen should be well ventilated to help eliminate odors associated with Self-Clean. Odors will lessen with use.
- The oven is preset for a 2.5 hour clean cycle; however, the time can be changed. Suggested clean times are 2 hours for light soil and between 3.0 hours and 3.5 hours for average to heavy soil.
- Clean mode stops automatically at the end of the set cleaning time.
- When the oven heat drops to a safe temperature, the automatic door lock will release and the door can be opened.

BEFORE SELF-CLEANING

1. Remove all utensils and bakeware.
2. Remove non-porcelain oven racks. If chromed racks are left in the oven during the self-clean cycle, they will permanently lose the shiny finish and change to a dull dark finish. See Oven Cleaning Chart for proper care.
3. Wipe up any soft soil spills and grease with paper towels. Excess grease will cause flames and smoke inside the oven during self-cleaning.
4. Be sure oven interior lights are turned off and the light bulbs and lens covers are in place.
5. Some areas of the oven such as the oven door edge, oven door window, oven front frame and up to 1½" (2-3 cm) inside the frame do not get hot enough during the cleaning cycle for soil to burn away and must be cleaned by hand BEFORE the cycle begins. Clean using a soapy sponge or plastic scrubber and a solution of detergent and hot water. Rinse and dry all areas thoroughly.

NOTE: Do not rub the oven door gasket.

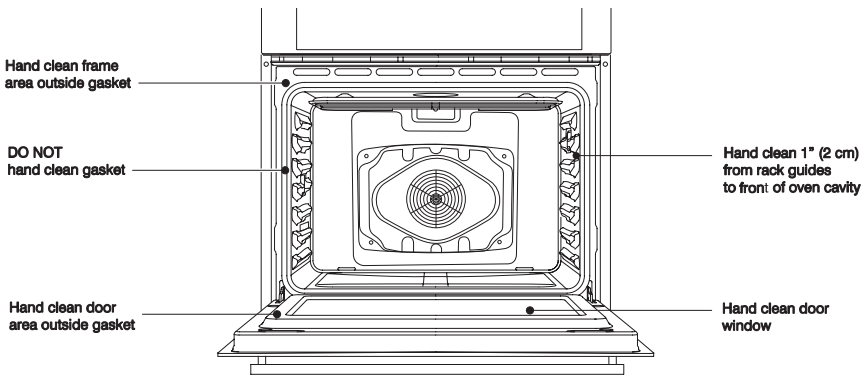

SELF-CLEAN CYCLE

NOTE: Only one oven can use the Self-Clean cycle at a time, and a 24-hour wait is recommended before starting the next Self-Clean cycle.

To Self-Clean:

1. Close the oven door.
2. Press SELF CLEAN. "Press 1 for Upper Oven" will appear in the upper oven text area of the display and "Press 2 for Lower Oven" will appear in the lower oven text area of the display.
3. Press "1" or "2" on the number keypad to select the desired oven. "REMOVE RACKS" will scroll in the selected oven text area of the display.
4. "2:00 3:00 3:30" will appear in the display.
5. Use the number keypad to select the clean level.
6. If you want to delay the start of the self-cleaning cycle, press DELAY START, and then set a time, by pressing the number keypad.
7. Press START.

After the door is locked, "SELF CLEAN" will scroll in the selected text area until the clean cycle is finished.

When the Self-clean Cycle Ends:

"COMPLETE" appears in the display and the oven door unlocks.

8. Once the oven has completely cooled, remove ash with a damp cloth.

NOTE: To avoid breaking the glass, do not apply a cool, damp cloth to the inner door glass before it has cooled completely.

OVEN DOOR REMOVAL

For normal oven use, there is no need to remove the oven door. However, should it become necessary to remove the door, follow the instructions in this section.

IMPORTANT:

- Make sure oven is cool and that power to the oven has been turned off before removing the door.
- The oven door is heavy and fragile, and the door front is glass. To avoid oven door glass breakage, use both hands, and grasp only the sides of the oven door to remove. Do not grasp the handle.
- Be sure both levers are securely in place before removing the door.
- Do not force door open or closed.

To Remove the Oven Door:

1. Open the door completely.
2. Flip up the hinge latch on each side.

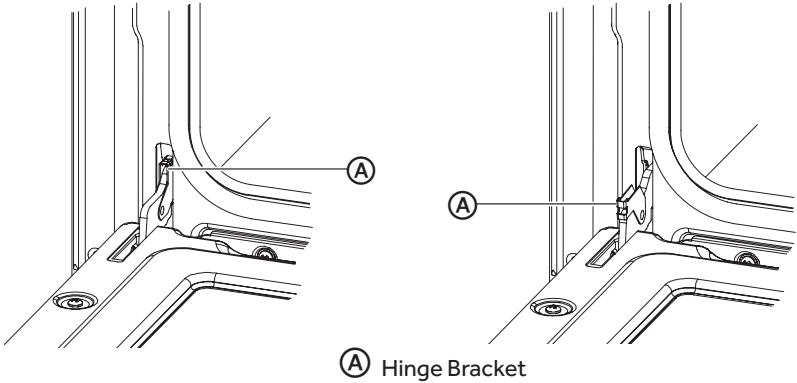

3. Holding the door firmly, close the oven door completely.
4. Grasping both sides, lift up on the oven door while pushing it closed, and then pull it away from the door frame.
5. Place the door in a protected location.

To Replace the Oven Door:

1. Insert the upper arms of both hinges into the slots. The recesses must hook on the lips.

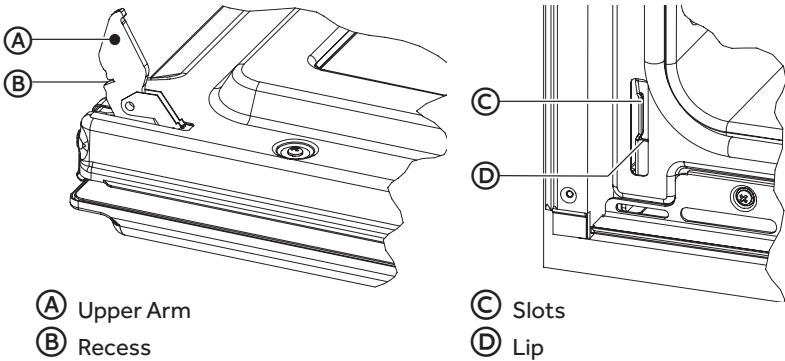

2. Open the oven door.

NOTE: You should hear a "click" sound when the door is correctly in place.

3. Move the hinge latch on each side back into the locked position.
4. Open and close the door to test that it operates freely. If it does not, repeat the door removal and replacement process.
5. Close and open the door slowly to assure that it is correctly and securely in place.

REPLACING AN OVEN LIGHT

WARNING



Electrical Shock Hazard

Make sure the oven and lights are cool and power to the oven has been turned off before replacing the light bulb(s).

The lenses must be in place when using the oven. The lenses serve to protect the light bulb from breaking.

The lenses are made of glass. Handle carefully to avoid breakage.

Failure to do so could result in death, electric shock, cuts or burns.

The oven light is a standard 25 watt (G9) appliance bulb.

IMPORTANT: Before replacing the bulb, make sure the oven is cool and the controls are turned off.

1. Disconnect power at the main power supply (fuse or circuit breaker box).
2. Remove the bulb cover by pulling it out of the opening.

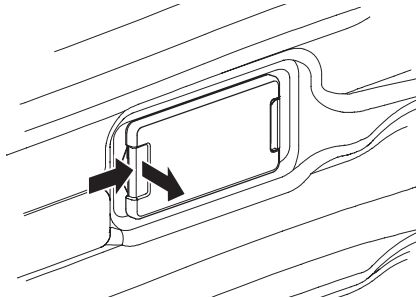

3. Remove the burned out bulb from the socket.

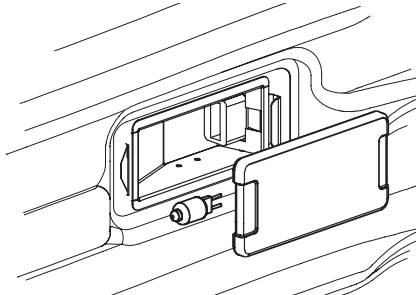

NOTE: To avoid damage to or decreasing the life of the new bulb, do not touch the bulb with bare fingers. Wear cotton gloves or use a tissue when replacing the light bulb.

4. Replace the bulb, and then replace the bulb cover.
5. Reconnect power at the main power supply (fuse or breaker box).

TROUBLESHOOTING

First try the solutions suggested here to possibly avoid the cost of a service call.

BAKING AND ROASTING

With either Bake or Convection Bake and Convection Roast poor results can occur for many reasons other than a malfunction of the oven. Check the chart below for causes of the most common problems. Since the size, shape and material of baking utensils directly affect the baking results, the best solution may be to replace old baking utensils that have darkened and warped with age and use. Check the Baking Charts for the correct rack position and baking time.

Baking Problem	Cause
Food browns unevenly	<ul style="list-style-type: none">• Oven not preheated• Aluminum foil on oven rack or oven bottom• Baking utensil too large for recipe• Pans touching each other or oven walls
Food too brown on bottom	<ul style="list-style-type: none">• Oven not preheated• Using glass, dull or darkened metal pans• Incorrect rack position• Pans touching each other or oven walls
Food is dry or has shrunk excessively	<ul style="list-style-type: none">• Oven temperature too high• Baking time too long• Oven door opened frequently• Pan size too large
Food is baking or roasting too slowly	<ul style="list-style-type: none">• Oven temperature too low• Oven not preheated• Oven door opened frequently• Tightly sealed with aluminum foil• Pan size too small
Piecrusts do not brown on bottom or crust is soggy	<ul style="list-style-type: none">• Baking time not long enough• Using shiny steel pans• Incorrect rack position• Oven temperature is too low

Cakes pale, flat and may not be done inside	<ul style="list-style-type: none"> • Oven temperature too low • Incorrect baking time • Cake tested too soon • Oven door opened too often • Pan size may be too large
Cakes high in middle with crack on top	<ul style="list-style-type: none"> • Oven temperature too high • Baking time too long • Pans touching each other or oven walls • Incorrect rack position • Pan size too small
Piecrust edges too brown	<ul style="list-style-type: none"> • Oven temperature too high • Edges of crust too thin

OPERATION

PROBLEM	POSSIBLE CAUSE	SOLUTION
F03 or F04 Error appears in the display window.	A problem with latch mechanism occurred.	Turn off power at the main power supply (fuse or breaker box), wait a few seconds and turn it back on again. The oven should run a latch auto-test. If condition persists, note the code number and call an authorized service center.
Other F_ Error appears in the display window.		Turn off power at the main power supply (fuse or breaker box), wait a few seconds and turn it back on again. If condition persists, note the code number and call an authorized service center.
The oven display does not illuminate.		Turn off power at the main power supply (fuse or breaker box). Turn breaker back on. If condition persists, call an authorized service center.
Cooling fan continues to run after oven is turned off.	The oven components have not cooled sufficiently.	The fan turns off automatically when the electronic components have cooled sufficiently.
Oven door is locked and will not release, even after cooling.		Turn the oven off at the circuit breaker and wait a few seconds. Turn breaker back on. The oven should reset itself and will be operable.
Oven is not heating.	No power going to the oven.	Turn on power at the main power supply (fuse or circuit breaker box). If condition persists, call an authorized service center.
	Oven Mode or Temperature not selected.	Turn control knobs to select the oven mode and temperature.

Oven is not cooking evenly	Oven rack is not in correct position.	Refer to cook charts for recommended rack position.
	Convection Bake Mode	Always reduce recipe temperature by 25°F (15 °C) when baking with Convection Bake mode.
Oven light is not working properly.	Light bulb is loose or burned out.	Replace or reinsert the light bulb if loose or defective. Touching the bulb with fingers may cause the bulb to burn out.
Oven light stays on.	Oven door does not close completely.	Check for obstruction in oven door. Check to see if hinge is bent or door switch is broken.
Cannot remove lens cover on light.	Lens cover is dirty.	There may be a soil build-up around the lens cover. Wipe lens cover area with a clean dry towel prior to attempting to remove the lens cover.
Oven will not Self- Clean properly.	Oven was still warm when Cleaning mode was selected.	Allow the oven to cool before running Self-Cleaning.
	Oven is heavily soiled.	Always wipe out loose soils or heavy spillover before running Self-Cleaning. See Preparing the Oven to Self-Clean. If oven is badly soiled, set oven for a 4-hour Self-Cleaning.
Clock and timer are not working properly.	No power going to the oven.	Turn on power at the main power supply (fuse or circuit breaker box). If condition persists, call an authorized service center.
	Clock or Timer not set correctly.	See the Clock and Timer sections.
Excessive moisture	Oven was not properly preheated.	When using bake mode, preheat the oven first. Convection Bake and Convection Roast will eliminate any moisture in oven (one of the advantages of convection).
Porcelain chips	Oven racks removed and replaced incorrectly.	When oven racks are removed and replaced, always tilt racks upward and do not force them to avoid chipping the porcelain.