

# AYANEO POCKET BLOCK

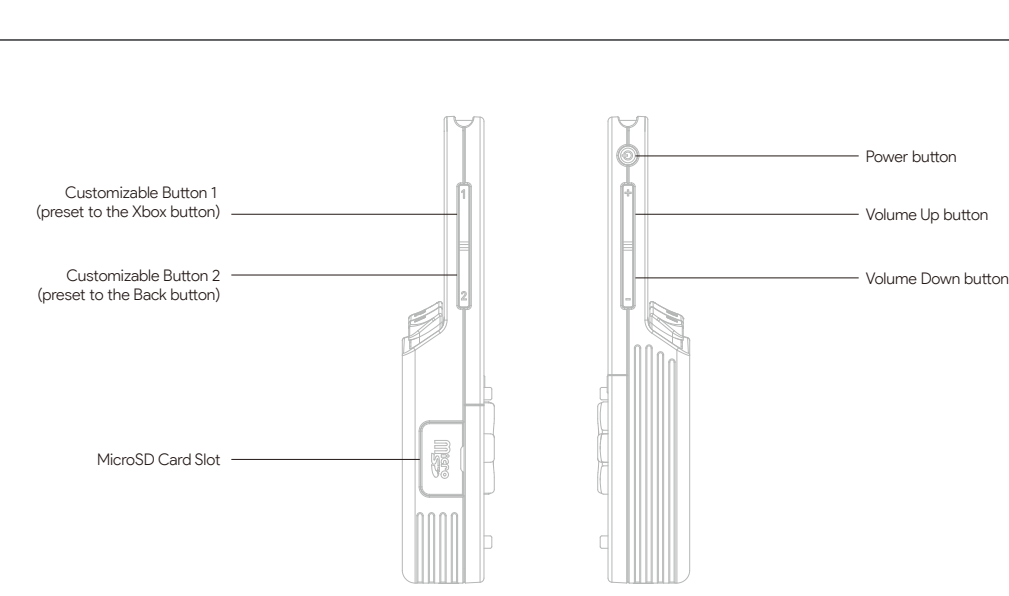

User Manual

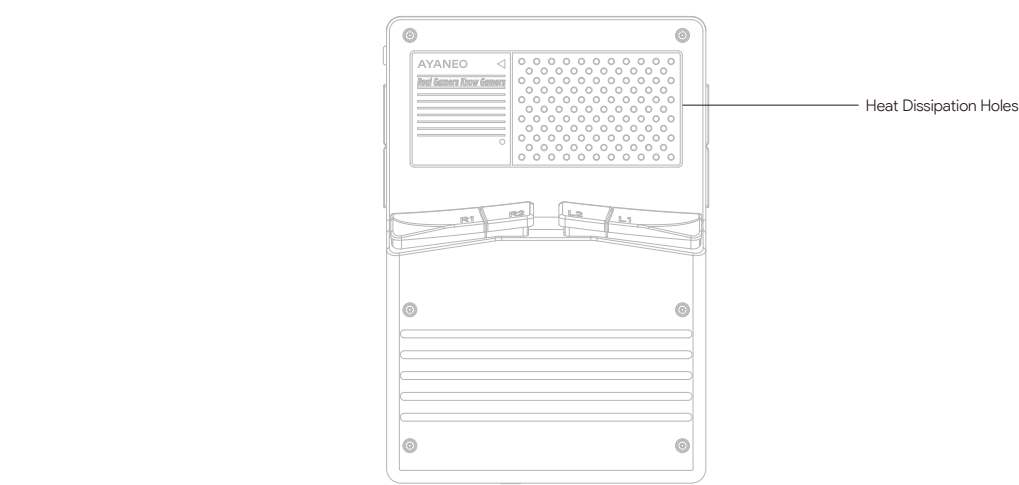
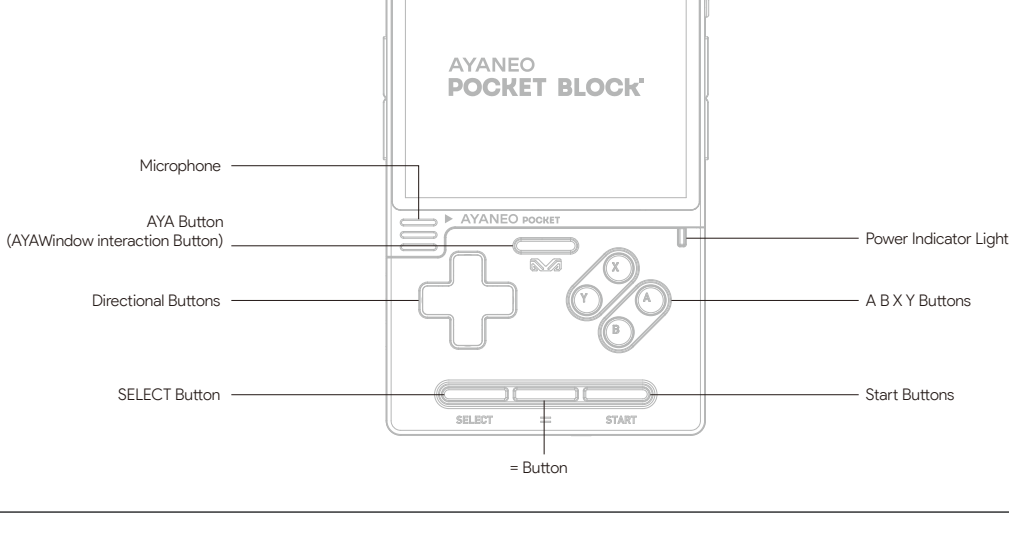

## Power On / Off / Restart

Turn on: In the off state, press and hold the power button "⏻" for about 3 seconds.

Turn off: In the on state, press and hold the power button "⏻" for about 2 seconds. In the pop-up menu, select "⏻" to turn off the AYANEO Pocket Block, or select "🔄" to restart the AYANEO Pocket Block.

## Exit Sleep Mode

Sleep Mode: While the device is on, press the power button "⏻" once.

Exit Sleep Mode: While the device is asleep, press the power button "⏻" once to wake it up. If screen lock is enabled, you will need to enter your password or PIN to unlock the device.

## Volume Control

Increase volume: Press the volume up button "🔊" to increase the volume one step at a time. Press and hold the button to continuously increase the volume.

Decrease volume: Press the volume down button "🔇" to decrease the volume.

To adjust volume settings: Go to "🔊" > "🔊" > "🔊" to adjust Media volume, Notification volume, Alarm volume, etc.

## Text Input

When you need to input text, simply tap on the text input field to automatically bring up the on-screen keyboard, and use the touch input to type your text.

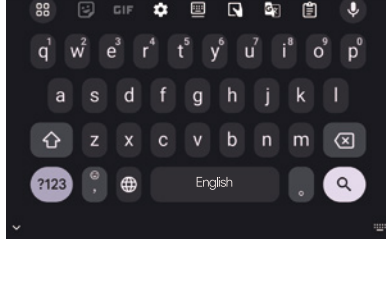

## Pull-down Menu

To access the pull-down menu, swipe down from the top of the screen for the first time to quickly toggle settings such as WLAN and Bluetooth. Swipe down again to display the full pull-down quick menu. You can adjust the screen brightness by sliding the brightness slider, and perform other quick settings configurations.

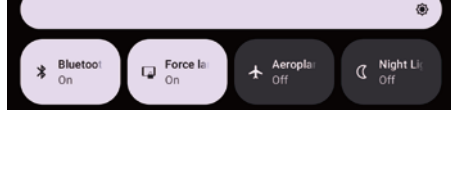

## Network / Bluetooth

AYANEO Pocket Block supports WLAN network. When you need to connect to the network through WLAN, set the "📶" and enter the settings menu home page, Network and Internet > "Internet". Select the network and enter the password, then click "Connect" to join the WLAN network.

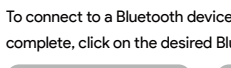

To connect to a Bluetooth device, go to the main settings menu and select "Connected Devices" > "Pair with New Device". Once the device search is complete, click on the desired Bluetooth device from the list to initiate the connection.

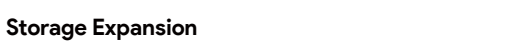

## Storage Expansion

The AYANEO Pocket Block has a Micro SD card slot on the left side of the device. To use it, open the dust cover and insert the storage card.

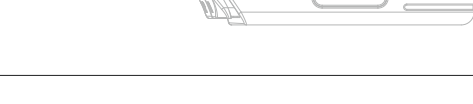

## Battery and Charge

Please use the certified adapter correctly for charging to ensure safety compliance. Do not use adapters without safety certification as they may damage internal components and pose unpredictable risks.

When plugging in a USB-C cable to a power source, avoid prolonged skin contact with the plug to prevent discomfort or injury. Do not attempt to replace the AYANEO Pocket Block battery on your own, as this may damage the battery, leading to overheating which could cause fires and personal injury.

The lithium-ion battery of the AYANEO Pocket Block should be serviced or recycled by AYANEO or authorized service providers. Self replacement of batteries may pose a risk of explosion.

Please follow local environmental regulations for battery disposal. The battery should only be replaced by AYANEO or an authorized AYANEO service provider. Using incorrect battery models for replacement poses a risk of explosion.

## Cleaning

Please use a lint free cloth to clean AYANEO Pocket Block. Do not let the opening of the body get damp. Do not use aerosol sprays, solvents, or abrasives for cleaning.

## Electromagnetic Interference (EMI)

The AYANEO Pocket Block contains components with magnets and emits electromagnetic fields from radio waves, which may interfere with medical devices, pacemakers, defibrillators, or other medical equipment. Maintain a safe distance between medical devices and the AYANEO Pocket Block. Consult your physician and the medical device manufacturer for information on your medical devices. If you suspect that the AYANEO Pocket Block is interfering with your pacemaker, defibrillator, or other medical devices, stop using the AYANEO Pocket Block.

## Warranty

AYANEO warrants the hardware products and accessories included with your purchase against defects in materials and workmanship under normal use for one year from the date of original retail purchase. This warranty does not cover normal wear and tear or damage caused by accidents or misuse. For service, visit the AYANEO store or an authorized AYANEO service provider. Available service options may depend on the country or region where the service is requested and may be limited to the country or region of original sale. There may be a charge for call and international shipping fees, depending on your location.

## Service and Support

When you submit a valid claim under the warranty service policy, AYANEO will, at its discretion, repair, replace, or refund your AYANEO Pocket Block. The warranty rights you have are in addition to the rights provided by local consumer law. When you make a claim under this warranty policy, you may be required to provide detailed information about your purchase receipt.

For more support and troubleshooting information, please visit [www.ayaneo.com](http://www.ayaneo.com)

## Names and Contents of Hazardous Substances in the Product

Part Name	Hazardous Substance					
	Pb	Hg	Cd	Cr(VI)	PBB	PBDE
PCB Components	×	○	○	○	○	○
Plastic Parts	○	○	○	○	○	○
Metal Parts	×	○	○	○	○	○
Power Cables	○	○	○	○	○	○

## This table is compiled according to SJ/T11364 regulations

○: Indicates that the content of the hazardous substance in all homogeneous materials of the part is below the limit requirement specified in GB/T26572.

×: Indicates that the content of the hazardous substance in at least one homogeneous material of the part exceeds the limit requirement specified in GB/T26572.

Note: This product applies an environmentally friendly design concept and effectively controls hazardous substances. The "X" indicates that the hazardous substance is primarily due to the limitations of technological development, making substitution of the hazardous substance impossible.

## Environmental Protection Use Period

The symbol indicates the period (ten years) during which the hazardous substances contained in electronic and electrical products will not leak or undergo severe changes under normal use conditions. During this period, the use of these electronic and electrical products will not cause severe pollution to the environment or cause serious harm to the user's health and property.



- The maximum operating ambient temperature of the product is 35°C.
- If consumers use a power adapter for power supply, they should purchase and use a power adapter that has obtained CCC certification and meets the standard requirements.
- Replacing with a battery pack of the wrong model poses a risk of fire or explosion.
- Do not place the battery pack in extremely high temperature or extremely low pressure environments, or subject the battery pack to mechanical extrusion or cutting, as this may cause an explosion or leakage of flammable liquids or gases.



Caution: Please do not listen at high volume for extended periods, as there is a risk of hearing damage.

## **FCC Statement**

This equipment has been tested and found to comply with the limits for a Class B digital device, pursuant to part 15 of the FCC rules. These limits are designed to provide reasonable protection against harmful interference in a residential installation. This equipment generates, uses and can radiate radio frequency energy and, if not installed and used in accordance with the instructions, may cause harmful interference to radio communications. However, there is no guarantee that interference will not occur in a particular installation. If this equipment does cause harmful interference to radio or television reception, which can be determined by turning the equipment off and on, the user is encouraged to try to correct the interference by one or more of the following measures:

- Reorient or relocate the receiving antenna.
- Increase the separation between the equipment and receiver.
  - Connect the equipment into an outlet on a circuit different from that to which the receiver is connected.
- Consult the dealer or an experienced radio/TV technician for help.

To assure continued compliance, any changes or modifications not expressly approved by the party.

Responsible for compliance could void the user's authority to operate this equipment. (Example- use only shielded interface cables when connecting to computer or peripheral devices).

This equipment complies with Part 15 of the FCC Rules. Operation is subject to the following two conditions:

- (1) This device may not cause harmful interference, and
- (2) This device must accept any interference received, including interference that may cause undesired operation.

Specific Absorption Rate (SAR) information: This device meets the government's requirements for exposure to radio waves. The guidelines are based on standards that were developed by independent scientific organizations through periodic and thorough evaluation of scientific studies. The standards include a substantial safety margin designed to assure the safety of all persons regardless of age or health.

FCC RF Exposure Information and Statement the SAR limit of USA (FCC) is 1.6 W/kg averaged over one gram of tissue. Device types: device has also been tested against this SAR limit. This device was tested for typical body-worn operations with the back of the Tablet computer kept 0mm from the body. To maintain compliance with FCC RF exposure requirements, use accessories that maintain an 0mm separation distance between the user's body and the back of the Tablet computer.

The use of belt clips, holsters and similar accessories should not contain metallic components in its assembly. The use of accessories that do not satisfy these requirements may not comply with FCC RF Exposure requirements, and should be avoided.