

**GARMIN®**

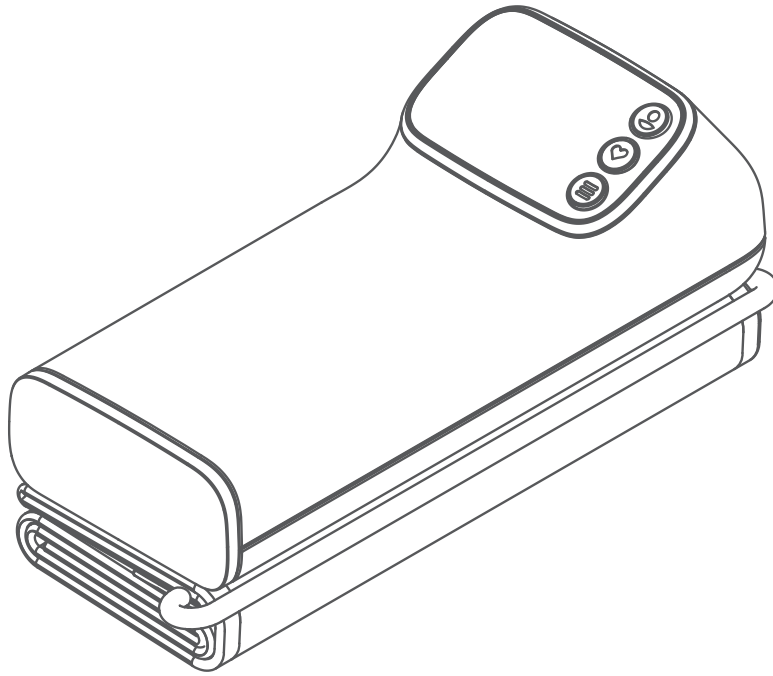

# INDEX™ BPM

---

## Owner's Manual

© 2022 Garmin Ltd. or its subsidiaries

All rights reserved. Under the copyright laws, this manual may not be copied, in whole or in part, without the written consent of Garmin. Garmin reserves the right to change or improve its products and to make changes in the content of this manual without obligation to notify any person or organization of such changes or improvements. Go to [www.garmin.com](http://www.garmin.com) for current updates and supplemental information concerning the use of this product.

Garmin® and the Garmin logo are trademarks of Garmin Ltd. or its subsidiaries, registered in the USA and other countries. Garmin Connect™ and Index™ are trademarks of Garmin Ltd. or its subsidiaries. These trademarks may not be used without the express permission of Garmin.

American Heart Association® is a registered trademark of American Heart Association, Inc. The BLUETOOTH® word mark and logos are owned by Bluetooth SIG, Inc. and any use of such marks by Garmin is under license. Wi-Fi® is a registered trademark of Wi-Fi Alliance Corporation. Other trademarks and trade names are those of their respective owners.

This device was manufactured by Ya Horng Electronic Co., Ltd.

M/N: BP707

Sponsor for Australian Purchases: Emergo Australia, Level 20 Tower II, Darling Park, 201 Sussex Street, Sydney, NSW 2000, Australia

# Table of Contents

Maintenance..... 22

## Important Safety and Product Information..... 1

Warning.....	0
Notice.....	0
Intended Use.....	2

## Device Overview..... 2

Activating the Device.....	3
Tips for Getting a Good Measurement.....	3
Tips for Adjusting the Cuff.....	4
Measuring Your Blood Pressure and Pulse Rate.....	5
Blood Pressure Categories.....	6

## Smart Features..... 7

Connecting to a Wi-Fi Network.....	7
Changing the Wi-Fi Network.....	7
Garmin Connect App.....	7
Inviting Secondary Users.....	8
Changing the User Profile.....	8

## Device Information..... 9

Resetting the Device.....	9
Replacing the Batteries.....	9
Troubleshooting.....	9
Device Care.....	9
Specifications.....	11
Symbol Definitions.....	12
Error Codes.....	14
Manufacturer Information.....	14
Radio Frequency Radiation Exposure..	14
RF Exposure Information (SAR).....	14
FCC Compliance.....	15
FCC RF Radiation Exposure Statement.....	15
RF Statement.....	15
Software License Agreement.....	16
Consumer Limited Warranty.....	16
Disposal.....	17
Guidance and Manufacturer's Declaration - Electromagnetic Emissions.....	18
Declaration - Electromagnetic Emissions and Immunity.....	19





# Important Safety and Product Information

## WARNING

Read all instructions carefully before installing and using the Index BPM device.

## WARNING

Failure to heed the following warnings could result in death, serious injury, or property damage.

### Health Warnings

- Do not use this product if you have a pacemaker or other internal electronic device.
- Do not use this product if you are pregnant, if you think you may be pregnant, or if you are pregnant and experiencing pre-eclampsia or toxemia.
- Always consult your physician before beginning or modifying any exercise program.
- Measurements provided by this device are for reference only. Garmin® is not responsible for the consequences of erroneous information. This device is not intended to diagnose, treat, cure, or prevent any disease.
- Do not adjust your medication based on measurements provided by this device. Take medication as prescribed by your physician. Only a physician is qualified to diagnose and treat high blood pressure.
- This device is not for use in an oxygen-rich environment.
- This product is not intended to undergo medical device sterilization.
- Do not use this device on the same limb as another health monitoring device.
- If you have had a mastectomy, do not use this device on the arm on the same side as your mastectomy.

### Battery Warnings

Replaceable alkaline batteries should be used with this device.

If these guidelines are not followed, batteries may experience a shortened life span or may present a risk of damage to the device, fire, chemical burn, electrolyte leak, and/or injury.

- **KEEP BATTERIES AWAY FROM CHILDREN.** Never put batteries in the mouth or in any part of the body. Severe or fatal injuries can occur within 2 hours. Seek medical attention immediately.
- Do not force discharge, recharge, disassemble, heat above the temperature ranges specified in the printed manual, or incinerate. Doing so may result in injury due to venting, leakage, or explosion resulting in chemical burns.
- Remove and immediately recycle or dispose of used batteries according to local regulations and keep away from children. Do NOT dispose of batteries in household trash or incinerate. Even used batteries may cause severe injury or death. Call a local poison control center for treatment information.
- Do not modify, remanufacture, puncture, or damage the device or batteries.
- Only replace batteries with correct replacement batteries. Using other batteries presents a risk of fire or explosion.
- Do not mix old and new batteries, different brands or types of batteries, such as alkaline, carbon-zinc, or rechargeable batteries.
- Ensure the batteries are installed correctly according to polarity (+ and -).
- Remove and immediately recycle or dispose of batteries from equipment not used for an extended period of time according to local regulations.
- Non-rechargeable batteries are not to be recharged.

## NOTICE

Failure to heed the following notices could result in personal or property damage, or negatively impact the device functionality.

## User Restrictions

This product is not intended for use by children under the age of 18.

---

## Battery Notice

Contact your local waste disposal department to dispose of the device/batteries in accordance with applicable local laws and regulations.

---



## Intended Use

The Index BPM device is a tubeless blood pressure monitor. This is a medical device intended to measure systolic and diastolic blood pressure and pulse rate. The device is designed for measurement and operation by adults age 18 to 75. The device is designed to measure adults (age 18 to 75) with an upper arm circumference of 22 to 42 cm (8.6 to 16.5 in.). This is a not a diagnostic device. You should contact your physician if the device displays hypertensive or high blood pressure values. There are no known side effects for using this device.

The Index BPM device is a standalone device that measures and displays blood pressure and pulse rate. You are not required to connect the device to a smartphone app. The optional smartphone app can only be used to store data for personal record keeping.

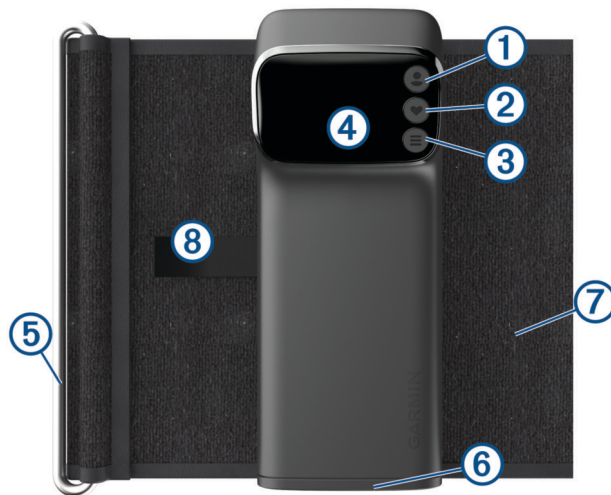
## Device Overview



① 	User
② 	Measurement
③ 	Menu
④	Display
⑤	Retaining bar
⑥	Battery cover
⑦	Cuff
⑧	Tab

## Activating the Device

- 1 Remove the pull tab from the battery cover.

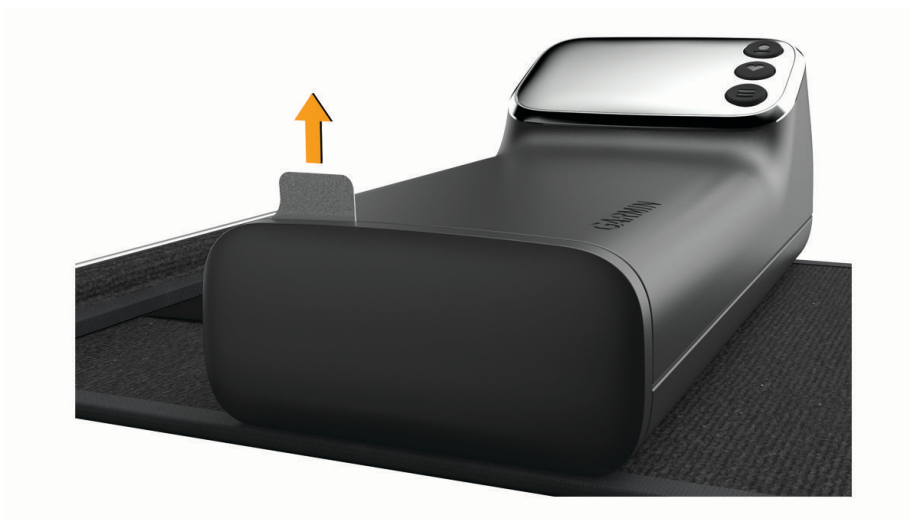

- 2 Press any button.

## Tips for Getting a Good Measurement

The Index BPM device displays your results for few seconds and automatically powers off.

- Read all of the instructions before measuring.
- Avoid eating, smoking, or exercise before measuring.
- After sliding the cuff strap onto your arm, relax for at least 5 minutes before measuring.
- Use the same arm each time you measure.
- Measure at a consistent time of day.
- Avoid tight or bulky clothing that could constrict blood flow.
- Avoid talking during measurements.
- Avoid distractions during measurements.

## Tips for Adjusting the Cuff

The Index BPM cuff should be as snug as possible while remaining comfortable.

**NOTE:** It may be easier to adjust the cuff before wearing it.

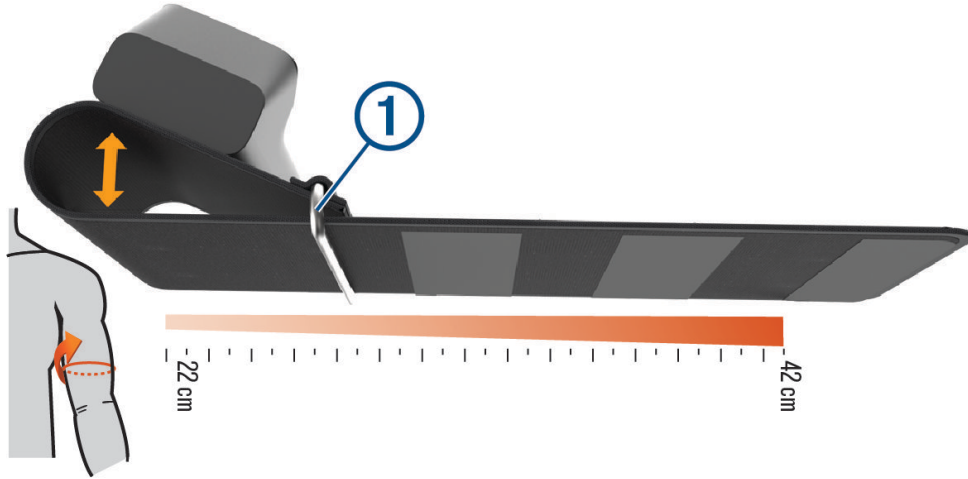

- Slide the retaining bar ① anywhere along the cuff, and fold the cuff over the retaining bar to form a loop.  
**TIP:** If necessary for a proper fit, you can position the retaining bar on a section of hook material.
- For larger arms, position the bar further away from the main housing.
- Once the cuff has been adjusted for a proper fit, keep the loop formed so you can slide the blood pressure monitor on and off during usage without further adjustment.

## Measuring Your Blood Pressure and Pulse Rate

For tips on how to get an accurate measurement of your blood pressure and pulse rate, see [Tips for Getting a Good Measurement, page 3](#).

You can take a single measurement (1X), or you can take three consecutive measurements and calculate the average (3X).

- 1 Unfold the cuff strap.
- 2 Grip the retaining bar, and loosen the cuff strap by pulling the cuff strap through the retaining bar until it forms a loop.

**TIP:** If necessary, pull the retaining bar away from the device to begin forming the loop.

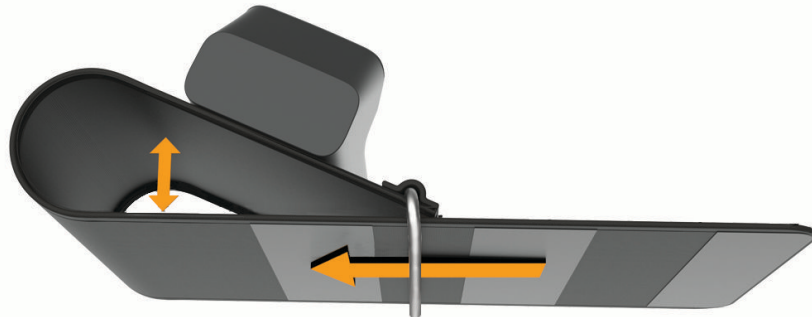

- 3 Fold the cuff strap over the retaining bar, and fasten the hook and loop strap.
- 4 Place your arm into the cuff loop, and slide the device to your upper arm.

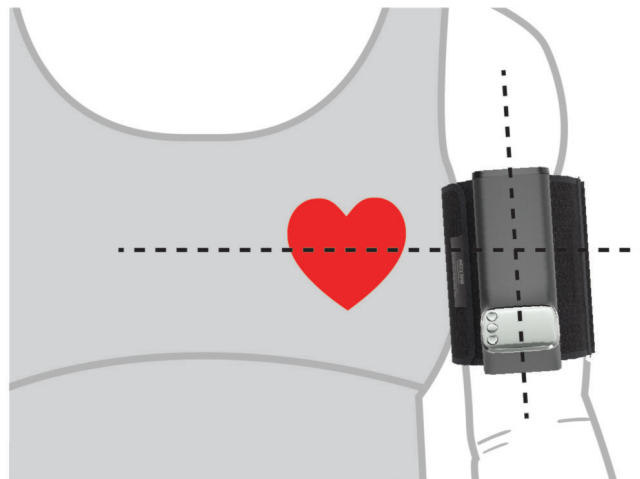

The device should be above your elbow and level with your heart. The screen should face you.

**TIP:** After you have adjusted the cuff to fit properly on your arm, you should be able to slide the fastened cuff on and off without adjusting it for every use.





- 5 If necessary, remove the cuff from your arm, and readjust the cuff so it is snug but comfortable ([Tips for Adjusting the Cuff, page 4](#)).

**NOTE:** If the device is not snug, the measurements may not be accurate.

- 6 Sit down with your feet flat on the floor.
- 7 Place your arm on a table or flat surface.

8 Press any button to wake up the device.

9 Select an option:

- For a 1X measurement, press .  
 appears.
- For a 3X measurement, hold .  
 appears.

**NOTE:** There is a one minute rest period between each measurement. Do not move or talk until the third measurement is complete.

The arm cuff automatically inflates and deflates for each measurement. The results appear on the screen.





If you have set up your device with an optional Wi-Fi® connection, the measurements are uploaded automatically to your Garmin Connect™ account.

## Stopping a Measurement

You can stop a measurement at any time.

- 1 Press .
- 2 Slide the fastened cuff off of your upper arm.

## Viewing Your Last Measurement

- 1 Press  > .  
 appears on the screen.
- 2 Press .

## Blood Pressure Categories

### CAUTION

This chart is not intended to provide medical diagnosis. You must consult your physician to interpret the measurements.

The data in this chart is provided by the American Heart Association®.

Category	Systolic (mmHg)	Diastolic (mmHg)
Normal	< 120	and < 80
Elevated	120 to 129	and < 80
High blood pressure, stage 1	130 to 139	or 80 to 89
High blood pressure, stage 2	≥ 140	or ≥ 90
Hypertensive crisis	>180	and/or > 120

# Smart Features

## Connecting to a Wi-Fi Network

### NOTICE

Do not attempt to pair the device with a phone that is not your personal device.



Do not attempt to connect the device to an unsecured Wi-Fi network, or a Wi-Fi network that does not have a password.

Do not share your account credentials or password.

You must connect your blood pressure monitor to the Garmin Connect app on your phone before you can connect to a Wi-Fi network.



It is optional and not required to use a Wi-Fi network with your Index BPM device. Your Index BPM device can sync measurements with the Garmin Connect app while connected to a Wi-Fi network.

The Index BPM device uses security measures to prevent data breaches. For example, the Garmin Connect app uses an authentication key to ensure that you can only pair the blood pressure monitor to one phone at a time, and you must enter a 6-digit pairing code displayed on your device to complete secured and bonded pairing.

- 1 Move within range of a Wi-Fi network.
- 2 Press any button to wake up the blood pressure monitor.
- 3 Press   
 appears.
- 4 Press .
- 5 From the Garmin Connect app, **••• > Garmin Devices > Add Device.**
- 6 Enter the security code displayed on your blood pressure monitor.
- 7 Enter a name for your blood pressure monitor.
- 8 Select an available Wi-Fi network, and enter the login details.

## Changing the Wi-Fi Network

You can add or change connected Wi-Fi networks from the Garmin Connect app on your phone. Secondary users cannot manage Wi-Fi networks.

- 1 Move within range of a Wi-Fi network.
- 2 Press any button to wake up the blood pressure monitor.
- 3 Press   
 appears.
- 4 Press .
- 5 From the Garmin Connect app, select **••• > Garmin Devices**, and select your blood pressure monitor.
- 6 Select **Connectivity > Wi-Fi > My Networks.**
- 7 Follow the on-screen instructions.

## Garmin Connect App

It is optional and not required to use the Garmin Connect app with your Index BPM device. The Garmin Connect app allows you to view blood pressure measurements, create notes for your measurements, invite people to use your device, and manage blood pressure reading reminders.

The Index BPM device runs in standalone mode until you download and pair the device with the Garmin Connect app.





## Downloading the App

It is optional and not required to use the Garmin Connect app with your Index BPM device.

- 1 On your compatible smartphone, open the application store, and search for the Garmin Connect app.
- 2 Install the app.  
See the owner's manual for your smartphone for more information.

## Pairing Your Device with the Garmin Connect App

You can add the Index BPM device to your Garmin Connect account.





- 1 From the app store on your phone, install and open the  Garmin Connect app.
- 2 Select an option to add your device to your Garmin Connect account:
  - If this is the first device you have paired with the Garmin Connect app, follow the on-screen instructions.
  - If you have already paired another device with the Garmin Connect app, select **••• > Garmin Devices > Add Device**, and follow the on-screen instructions.
- 3 To enter pairing mode on your blood pressure monitor, press any button to wake up the device, and press .  
 appears.
- 4 Press .
- 5 Follow the on-screen instructions on the Garmin Connect app.

New measurements automatically upload to the Garmin Connect app.

## Inviting Secondary Users

Before you can invite secondary users, the secondary users must install the Garmin Connect app on their phone and create an account.

You can invite up to 15 secondary users to create a profile and take measurements on your blood pressure monitor using the Garmin Connect app.

- 1 From the Garmin Connect app on your phone, select **••• > Garmin Devices**, and select your blood pressure monitor.
- 2 Select **Manage Users > Invite Connections**.
- 3 Select **Invite** next to the user.  
The secondary user receives an email inviting them to use your blood pressure monitor.
- 4 From the secondary user's phone, accept the email invitation, and follow the on-screen instructions.
- 5 Press .  
 appears.
- 6 Press .
- 7 Once the device finishes syncing, press  to select the secondary user ([Changing the User Profile, page 8](#)).
- 8 Take a measurement on your Index BPM device.  
The Index BPM device syncs and the new user's profile becomes available.

## Changing the User Profile

Before you can change the user profile, you must complete the invitation process for secondary users and sync the device with your Garmin Connect account.

- 1 Press any button to wake up the device.
- 2 Press  until the user's name appears.
- 3 Take a measurement.

If you have set up your device with an optional Wi-Fi connection, the measurements upload to the secondary user's Garmin Connect account automatically.

# Device Information

## Resetting the Device

Resetting the device erases all data and connections.

While the device is off, hold  and  for 10 seconds.

 appears, and the device resets.

## Replacing the Batteries

The device operates on four AAA batteries.

- 1 Press the battery cover button located behind the cuff.
- 2 Remove the battery cover.
- 3 Remove the batteries from the device.
- 4 Insert the new batteries, observing polarity.



- 5 Replace the battery cover.

## Troubleshooting

### My device will not sync my measurements with the app

- Verify that you have completed the setup process.
- Verify the device is connected using Wi-Fi technology.

After you take a measurement, the device automatically attempts to sync through programmed Wi-Fi networks. Measurements are stored in the user's account until the device syncs successfully with the app.

## Device Care

### NOTICE

Avoid extreme shock and harsh treatment, because it can degrade the life of the product.

Do not store the device where prolonged exposure to extreme temperatures can occur, because it can cause permanent damage.

When you do not plan to use the device for several months, remove the batteries.

Do not use a sharp or abrasive object to clean the device.

Avoid chemical cleaners, abrasive cleaners, solvents, and insect repellents that can damage plastic components and finishes.

Avoid leaving the device in direct sunlight.

## Cleaning the Device

If necessary, you can clean the surface of the device to remove unwanted residue, lint, and dust.

**NOTE:** You should clean the device at least once a year.

- 1 Clean the surface of the device using a cloth dampened with a mild detergent solution or clean water.
- 2 Wipe the device dry.

## Storing the Device

- Roll the cuff strap until it is against the device, and secure the cuff with the hook and loop tab.
- Store the device in a cool, dry place, away from direct sunlight.
- Remove the batteries if you do not plan to use the device for more than 3 months to prevent battery leakage.

## Specifications

Display	3.3 cm (1.3 in.) OLED
Cuff pressure range	From 0 to 280 mmHg
Measurement range	Systolic blood pressure: from 60 to 250 mmHg Diastolic blood pressure: from 40 to 180 mmHg
Measurement method	Oscillometric
Accuracy	Blood pressure value: $\pm 3$ mmHg or $\pm 2\%$ Pulse: $\pm 5\%$
Power rating	DC 6 V, 4 1.5 V LR03 AAA batteries
Arm circumference	From 22 to 42 cm (from 8.6 to 16.5 in.)
Weight	280 grams (0.62 lb.) without batteries
Dimensions	150 x 60 x 80 mm
Battery life	Up to 9 mo.
Operating temperature range	From 10° to 40°C (from 50° to 104°F) From 15% to 90% relative maximum humidity Maximum altitude: 2,000 m (6561.68 ft.)
Storage temperature range	From -25° to 50°C (from -13° to 122°F) From 10% to 95% relative maximum humidity Maximum altitude: 2,000 m (6561.68 ft.) From 800 to 1,060 hPa
Transmission method	Bluetooth® low energy 5.0
Wireless network capability	IEEE 802.11 b/g/n
Warranty	One yr.
Applied part	Type BF (upper arm cuff)
Contents	BP707 4 AAA batteries Cuff (attached) Quick start manual
Expected service life	3 yr.
Power on or wake up time	5 sec.
Measurement cycle time	From 50 to 60 sec., according to pressure value
Wireless frequency	Wi-Fi: 2412 to 2462 MHz @18.04 dBm Bluetooth Low Energy: 2402 to 2480 MHz @ -2.33 dBm
Bluetooth Low Energy	5.0
Bluetooth Low Energy range	<30 ft. (typical)
Maximum number of connections	1 smartphone
Wireless networks	b/g/n 2.4 GHz only





















Wireless network security	WPA2
Wireless network range	<100 ft. (typical)
Maximum number of wireless networks	7 stored

## Symbol Definitions

These symbols and abbreviations may appear on the device labels.



	Do not use this product if you have an implanted pacemaker.
	Read the instructions before use.
	Applied part, type BF.
	Manufacturer
	Importer
	Distributor
	Class II symbol
	WEEE disposal and recycling symbol. The WEEE symbol is attached to the product in compliance with the EU directive 2012/19/EU on Waste Electrical and Electronic Equipment (WEEE). It is intended to deter the improper disposal of this product and to promote reuse and recycling.
	Low battery warning. Indicates that the battery is lower than 50%.
	Battery is too low to switch the device on and should be changed immediately.
	Universal recycling symbol.
	FCC certification mark.
	Storage and transportation conditions.
	Storage and transportation conditions.
	CE certification mark.
	Green Dot packaging. A financial contribution has been paid to a qualified national packaging recovery organization.
	Bluetooth symbol.
	Do not use this device in an MR (magnetic resonance) environment.
IP22	The device is protected against solid foreign objects greater than 12.5 mm (0.49 in.). The device is protected against water sprayed up to 15° from vertical.
S/N	Serial number.
SYS / DIA	Systolic blood pressure in mmHg/ diastolic blood pressure in mmHg.
BPM	Heart beats per minute during a measurement.
	Medical device.



<b>UDI</b>	Unique device identification.
------------	-------------------------------

## Error Codes

Error codes may appear on the device screen to indicate a problem with the device (*Tips for Getting a Good Measurement, page 3*). If your Index BPM device displays an error code, you should remove the device from your arm and turn the device off and on before attempting another measurement.

	The device battery level is low.
E1	The device did not detect a measurement.
E2	The cuff did not inflate properly or has a leak.
E3	The measurement is incorrect.
E4	The device timed out while the cuff was inflating or deflating.
E5	The cuff is partially inflated.
E6	The measurement exceeded the maximum blood pressure value.
E7	The device timed out while attempting to connect to the Garmin Connect app or a Wi-Fi network.
E8	The device experienced an internal communications error.
E9	The software update did not install properly.
E10	The device timed out.
X	The device timed out while attempting to upload a measurement or complete setup.

## Manufacturer Information

- Ya Horng Electronic Co., Ltd.
- [www.yahorng.com](http://www.yahorng.com)
- +886-6593-2201
- [healthcare@yahorng.com](mailto:healthcare@yahorng.com)
- No. 35, Shalun, Anding Dist., Tainan City, TAIWAN

## Radio Frequency Radiation Exposure

This device is a portable transmitter and receiver that uses an internal antenna to send and receive low levels of radio frequency (RF) energy for data communications. The device emits RF energy below the published limits for portable use when operating in its maximum output power mode and when used with Garmin authorized accessories. To comply with RF exposure compliance requirements, the device should be used as described in the manual. The device should not be used in other configurations.

## RF Exposure Information (SAR)

This device meets the government's requirements for exposure to radio waves. This device is designed and manufactured not to exceed the emission limits for exposure to radio frequency (RF) energy set by the Federal Communications Commission of the U.S. Government. The exposure standard employs a unit of measurement known as the Specific Absorption Rate, or SAR. The SAR limit set by the FCC is 1.6 W/kg. Tests for SAR are conducted using standard operating positions accepted by the FCC with the EUT transmitting at the specified power level in different channels. The FCC has granted an Equipment Authorization for this device with all reported SAR levels evaluated as in compliance with the FCC RF exposure guidelines. SAR information on this device is on file with the FCC and can be found under the Display Grant section of [www.fcc.gov](http://www.fcc.gov) after searching on FCC ID:Z50-BP707.

## FCC Compliance

This device complies with part 15 of the FCC Rules. Operation is subject to the following two conditions: (1) this device may not cause harmful interference, and (2) this device must accept any interference received, including interference that may cause undesired operation.

This equipment has been tested and found to comply with the limits for a Class B digital device, pursuant to part 15 of the FCC rules. These limits are designed to provide reasonable protection against harmful interference in a residential installation. This equipment generates, uses, and can radiate radio frequency energy and may cause harmful interference to radio communications if not installed and used in accordance with the instructions. However, there is no guarantee that interference will not occur in a particular installation. If this equipment does cause harmful interference to radio or television reception, which can be determined by turning the equipment off and on, the user is encouraged to try to correct the interference by one of the following measures:

- Reorient or relocate the receiving antenna.
- Increase the separation between the equipment and the receiver.
- Connect the equipment into an outlet on a circuit different from that to which the receiver is connected.
- Consult the dealer or an experienced radio/TV technician for help.

This product does not contain any user-serviceable parts. Repairs should only be made by an authorized Garmin service center. Unauthorized repairs or modifications could result in permanent damage to the equipment, and void your warranty and your authority to operate this device under Part 15 regulations.

## FCC RF Radiation Exposure Statement

This equipment complies with FCC radiation exposure limits set forth for an uncontrolled environment. End users must follow the specific operating instructions for satisfying the RF exposure compliance. This transmitter must not be co-located or operated in conjunction with any other antenna or transmitter.

## RF Statement

Medical Electrical Equipment requires special precautions regarding ElectroMagnetic Compatibility (EMC) and needs to be installed and put into service according to the following EMC information.

- Interference may occur in the vicinity of equipment marked with portable and mobile RF communication equipment (e.g. cell phones) and can affect Medical Electrical Equipment.
- The device uses RF energy only for its internal function. Therefore, its RF emissions are very low and are not likely to cause any interference in nearby electronic equipment.
- The device is suitable for use in all establishments, including domestic establishments and those directly connected to the public low-voltage power supply network that supplies buildings used for domestic purposes.
- Portable and mobile RF communications equipment should be used no closer to any part of the device than the recommended separation distance, calculated from the equation applicable to the frequency of the transmitter. The device is intended for use in an electromagnetic environment in which radiated RF disturbances are controlled.
- Use of this equipment adjacent to or stacked with other equipment should be avoided because it could result in improper operation. If such use is necessary, this equipment and the other equipment should be observed to verify that they are operating normally.

## Software License Agreement

BY USING THE DEVICE, YOU AGREE TO BE BOUND BY THE TERMS AND CONDITIONS OF THE FOLLOWING SOFTWARE LICENSE AGREEMENT. PLEASE READ THIS AGREEMENT CAREFULLY.

Garmin Ltd. and its subsidiaries (“Garmin”) grant you a limited license to use the software embedded in this device (the “Software”) in binary executable form in the normal operation of the product. Title, ownership rights, and intellectual property rights in and to the Software remain in Garmin and/or its third-party providers.

You acknowledge that the Software is the property of Garmin and/or its third-party providers and is protected under the United States of America copyright laws and international copyright treaties. You further acknowledge that the structure, organization, and code of the Software, for which source code is not provided, are valuable trade secrets of Garmin and/or its third-party providers and that the Software in source code form remains a valuable trade secret of Garmin and/or its third-party providers. You agree not to decompile, disassemble, modify, reverse assemble, reverse engineer, or reduce to human readable form the Software or any part thereof or create any derivative works based on the Software. You agree not to export or re-export the Software to any country in violation of the export control laws of the United States of America or the export control laws of any other applicable country.

## Consumer Limited Warranty

THIS LIMITED WARRANTY GIVES YOU SPECIFIC LEGAL RIGHTS, AND YOU MAY HAVE OTHER LEGAL RIGHTS, WHICH VARY FROM STATE TO STATE (OR BY COUNTRY OR PROVINCE). GARMIN DOES NOT EXCLUDE, LIMIT OR SUSPEND OTHER LEGAL RIGHTS YOU MAY HAVE UNDER THE LAWS OF YOUR STATE (OR COUNTRY OR PROVINCE). FOR A FULL UNDERSTANDING OF YOUR RIGHTS, YOU SHOULD CONSULT THE LAWS OF YOUR STATE, COUNTRY OR PROVINCE.

Non-aviation products are warranted to be free from defects in materials or workmanship for one year from the date of purchase. Within this period, Garmin will, at its sole option, repair or replace any components that fail in normal use. Such repairs or replacement will be made at no charge to the customer for parts or labor, provided that the customer shall be responsible for any transportation cost. This Limited Warranty does not apply to: (i) cosmetic damage, such as scratches, nicks and dents; (ii) consumable parts, such as batteries, unless product damage has occurred due to a defect in materials or workmanship; (iii) damage caused by accident, abuse, misuse, water, flood, fire, or other acts of nature or external causes; (iv) damage caused by service performed by anyone who is not an authorized service provider of Garmin; (v) damage to a product that has been modified or altered without the written permission of Garmin; (vi) damage to a product that has been connected to power and/or data cables that are not supplied by Garmin or damage to a product that has been connected to AC adapters and cables that are not certified by UL (Underwriters Laboratories) and are not labeled as Limited Power Source (LPS). In addition, Garmin reserves the right to refuse warranty claims against products or services that are obtained and/or used in contravention of the laws of any country. Garmin navigation products are intended to be used only as a travel aid and must not be used for any purpose requiring precise measurement of direction, distance, location or topography. Garmin makes no warranty as to the accuracy or completeness of map data.

TO THE MAXIMUM EXTENT PERMITTED BY APPLICABLE LAW, THE WARRANTIES AND REMEDIES CONTAINED IN THIS LIMITED WARRANTY ARE EXCLUSIVE AND IN LIEU OF, AND GARMIN EXPRESSLY DISCLAIMS, ALL OTHER WARRANTIES AND REMEDIES, WHETHER EXPRESS, IMPLIED, STATUTORY, OR OTHERWISE, INCLUDING WITHOUT LIMITATION ANY IMPLIED WARRANTY OF MERCHANTABILITY OR FITNESS FOR A PARTICULAR PURPOSE, STATUTORY REMEDY OR OTHERWISE. THIS LIMITED WARRANTY GIVES YOU SPECIFIC LEGAL RIGHTS, AND YOU MAY HAVE OTHER LEGAL RIGHTS, WHICH VARY FROM STATE TO STATE AND FROM COUNTRY TO COUNTRY. IF IMPLIED WARRANTIES CANNOT BE DISCLAIMED UNDER THE LAWS OF YOUR STATE OR COUNTRY, THEN SUCH WARRANTIES ARE LIMITED IN DURATION TO THE DURATION OF THIS LIMITED WARRANTY. SOME STATES (AND COUNTRIES AND PROVINCES) DO NOT ALLOW LIMITATIONS ON HOW LONG AN IMPLIED WARRANTY LASTS, SO THE ABOVE LIMITATION MAY NOT APPLY TO YOU.

IN NO EVENT SHALL GARMIN BE LIABLE IN A CLAIM FOR BREACH OF WARRANTY FOR ANY INCIDENTAL, SPECIAL, INDIRECT OR CONSEQUENTIAL DAMAGES, WHETHER RESULTING FROM THE USE, MISUSE OR INABILITY TO USE THIS PRODUCT OR FROM DEFECTS IN THE PRODUCT. SOME STATES (AND COUNTRIES AND PROVINCES) DO NOT ALLOW THE EXCLUSION OF INCIDENTAL OR CONSEQUENTIAL DAMAGES, SO THE ABOVE LIMITATIONS MAY NOT APPLY TO YOU.

If during the warranty period you submit a claim for warranty service in accordance with this Limited Warranty, then Garmin will, at its option: (i) repair the device using new parts or previously used parts that satisfy Garmin's quality standards, (ii) replace the device with a new device or a Garmin Recertified device that meets Garmin's quality standards, or (iii) exchange the device for a full refund of your purchase price. SUCH REMEDY SHALL BE YOUR SOLE AND EXCLUSIVE REMEDY FOR ANY BREACH OF WARRANTY. Repaired or replaced devices have a 90-day warranty. If the device sent in is still under its original warranty, then the new warranty is 90 days or to the end of the original 1-year warranty, whichever is longer.

Before seeking warranty service, please access and review the online help resources available on [support.garmin.com](http://support.garmin.com). If your device is still not functioning properly after making use of these resources, contact a Garmin Authorized service facility in the original country of purchase or follow the instructions on [support.garmin.com](http://support.garmin.com) to obtain warranty service. If you are in the United States, you can also call 1-800-800-1020.

If you seek warranty service outside of the original country of purchase, Garmin cannot guarantee that the parts and products needed to repair or replace your product will be available due to differences in product offerings and applicable standards, laws and regulations. Accordingly, Garmin may, in its sole discretion and subject to applicable laws, repair your product with comparable parts or replace your product with a comparable Garmin product (new or a Garmin Recertified replacement), or require you to ship your product to a Garmin Authorized Service facility in the country of original purchase or to a Garmin Authorized service facility in another country that can service your product, in which case you will be responsible for complying with all applicable import and export laws and regulations and for paying all custom duties, V.A.T., shipping fees and other associated taxes and charges. In some cases, Garmin and its dealers may be unable to service your product in a country outside of the original country of purchase or return a repaired or replaced product to you in that country due to applicable standards, laws or regulations in that country.

**Online Auction Purchases:** Products purchased through online auctions are not eligible for rebates or other special offers from Garmin warranty coverage. Online auction confirmations are not accepted for warranty verification. To obtain warranty service, an original or copy of the sales receipt from the original retailer is required. Garmin will not replace missing components from any package purchased through an online auction.

**International Purchases:** A separate warranty may be provided by international distributors for devices purchased outside the United States depending on the country. If applicable, this warranty is provided by the local in-country distributor and this distributor provides local service for your device. Distributor warranties are only valid in the area of intended distribution. Devices purchased in the United States or Canada must be returned to the Garmin service center in the United Kingdom, the United States, Canada, or Taiwan for service

**Australian Purchases:** Our goods come with guarantees that cannot be excluded under the Australian Consumer Law. You are entitled to a replacement or refund for a major failure and for compensation for any other reasonably foreseeable loss or damage. You are also entitled to have the goods repaired or replaced if the goods fail to be of acceptable quality and the failure does not amount to a major failure. The benefits under our Limited Warranty are in addition to other rights and remedies under applicable law in relation to the products. Garmin Australasia, 30 Clay Place, Eastern Creek, NSW 2766, Australia. Phone: 1800 235 822.

## Disposal

Actuation of European directives 2011/65/EU, 2012/19/EU, and 2015/863/EU, for the reduction in use of dangerous substances in electric and electronic devices and for waste disposal. The symbol applied on the device or its packaging means that at the end of its useful life, the product must not be disposed of with domestic waste. At the end of the device's useful life, the user must deliver it to a designated collection point for electric and electronic waste, or give the device back to the retailer when purchasing a new device. Disposing of the product separately helps protect human health and the environment. The collection and recycling of your device also helps conserve natural resources. The device and its parts are marked with regard to disposal, as appropriate, in accordance with national or regional regulations.

## Guidance and Manufacturer's Declaration - Electromagnetic Emissions

The Index BPM is intended for use in the electromagnetic environment specified below. The customer or the user of the Index BPM device should assure that it is used in such an environment.

Emissions Test	Compliance	Electromagnetic Environment - Guidance
CE emission CISPR11	Group 1	The Index BPM device uses RF energy only for its internal function. Therefore, its RF emissions are very low and are not likely to cause any interference in nearby electronic equipment.
RE emissions CISPR11	Class B	The Index BPM device uses RF energy only for its internal function. Therefore, its RF emissions are very low and are not likely to cause any interference in nearby electronic equipment.
Harmonic emissions IEC 61000-3-2	Not applicable	The Index BPM device is suitable for use in all establishments, including domestic establishments and those directly connected to the public low-voltage power supply network that supplies buildings used for domestic purposes.
Voltage fluctuations/Flicker emissions IEC 61000-3-3	Not applicable	The Index BPM device is suitable for use in all establishments, including domestic establishments and those directly connected to the public low-voltage power supply network that supplies buildings used for domestic purposes.



## Declaration - Electromagnetic Emissions and Immunity

For equipment and systems that are not life-supporting and are specified for use only in a shielded location. Use of this equipment adjacent to or stacked with other equipment should be avoided because it could result in improper operation. If such use is necessary, this equipment and the other equipment should be observed to verify that they are operating normally. Portable RF communications equipment (including peripherals such as antenna cables and external antennas) should be used no closer than 30 cm (12 in.) to any part of the unit, including cables specified by the manufacturer. Otherwise, degradation of the performance of this equipment could result.

The Index BPM device is intended for use in the electromagnetic environment specified in the following table. The customer or the user of the Index BPM device should assure that it is used in such an environment.

Immunity Test	IEC 60601 Test Level	Compliance Level	Electromagnetic Environment - Guidance
Electrostatic Discharge (ESD) IEC 61000-4-2	Contact: $\pm 8$ kV Air: $\pm 2$ kV, $\pm 4$ kV, $\pm 8$ kV, $\pm 15$ kV	Contact: $\pm 8$ kV Air: $\pm 2$ kV, $\pm 4$ kV, $\pm 8$ kV, $\pm 15$ kV	Floors should be wood, concrete, or ceramic tile. If floors are covered with synthetic material, the relative humidity should be at least 30%.
Electrical fast transient/burst IEC 61000-4-4	$\pm 2$ kV for power supply lines $\pm 1$ kV for input/ output lines	N/A <sup>1</sup>	Mains power quality should be that of a typical commercial or hospital environment.
Surge IEC 61000-4-5	$\pm 0.5$ kV, $\pm 1$ kV line(s) to line(s) $\pm 0.5$ kV, $\pm 1$ kV, $\pm 2$ kV line(s) to earth	N/A	Mains power quality should be that of a typical commercial or hospital environment.
Voltage dips, short interruptions, and voltage variations on power supply input lines IEC 61000-4-11	Voltage dips: 0 % UT; 0,5 cycle 0 % UT; 1 cycle 70 % UT; 25/30 cycles Voltage interruptions: 0 % UT; 250/300 cycles	Voltage dips: N/A	Mains power quality should be that of a typical commercial or hospital environment. If the user of the Index BPM requires continued operation during power mains interruptions, it is recommended that the Index BPM be powered from an uninterruptible power supply or a battery.
Power frequency (50/60 Hz) magnetic field IEC 61000-4-8	30 A/m 50 Hz or 60 Hz	30 A/m 50 Hz and 60 Hz	The Index BPM power frequency magnetic fields should be at levels characteristic of a typical location in a typical commercial or hospital environment.

The Index BPM device is intended for use in the electromagnetic environment specified in the following table. The customer or the user of the Index BPM device should assure that it is used in such an environment.

**NOTE:** These guidelines may not apply in all situations. Electromagnetic propagation is affected by absorption and reflection from structures, objects, and people.

<sup>1</sup> Not Applicable. The Index BPM is battery-powered, not AC powered.

Immunity Test	IEC 60601 Test Level	Compliance Level	Electromagnetic Environment - Guidance
Conducted RFIEC 61000-4-6	3 Vrms 150 kHz to 80 MHz 6 Vrms: In ISM and amateur radio bands between 0,15 MHz and 80 MHz 80 % AM at 1 kHz	N/A <sup>2</sup>	Portable and mobile RF communications equipment should be used no closer to any part of the INDEX BPM, including cables, than the recommended separation distance calculated from the equation applicable to the frequency of the trans- mitter.
Radiated RF IEC 61000-4-3	10 V/m 80 MHz - 2,7 GHz 80 % AM at 1 kHz	10 V/m 80 MHz - 2,7 GHz 80 % AM at 1 kHz	Recommended separation distance: $d = 1,2\sqrt{P}$ $d = 1,2\sqrt{P}$ 80 MHz to 800 MHz <sup>3</sup> $d = 2,3\sqrt{P}$ 800 MHz to 2,7 GHz Where P is the maximum output power rating of the transmitter in watts (W) according to the trans- mitter manufacturer and d is the recommended separation distance in meters (m). Interference may occur in the vicinity of equipment marked with the following symbol: 

The Index BPM is intended for use in an electromagnetic environment (for home healthcare) in which radiated RF disturbances are controlled. The customer or the user of the Index BPM can help prevent electromagnetic interference by maintaining a minimum distance between portable and mobile RF communications equipment (transmitters) and the Index BPM as recommended in the following table, according to the maximum output power of the communications equipment.

<sup>2</sup> Not Applicable. The EUT is operating by battery, no supply for AC mains.

<sup>3</sup> At 80 MHz and 800 MHz, the higher frequency range applies.

**Recommended separation distance between portable and mobile RF communications equipment and the Index BPM**

Rated maximum output power of transmitter W	Separation distance according to frequency of transmitter m		
	150 kHz to 80 MHz $d = 1,2\sqrt{P}$	80 MHz to 800 MHz $d = 1,2\sqrt{P}$	800 MHz to 2,7 GHz $d = 2,3\sqrt{P}$
0,01	N/A	0,12	0,23
0,1	N/A	0,38	0,73
1	N/A	1,2	2,3
10	N/A	3,8	7,3
100	N/A	12	23

For transmitters rated at a maximum output power not listed above, the recommended separation distance d in meters (m) can be estimated using the equation applicable to the frequency of the transmitter, where p is the maximum output power rating of the transmitter in watts (W) according to the transmitter manufacturer.

**NOTE:** At 80 MHz and 800 MHz, the separation distance for the higher frequency range applies.

**NOTE:** These guidelines may not apply in all situations. Electromagnetic propagation is affected by absorption and reflection from structures, objects and people.

The Index BPM is intended for use in the electromagnetic environment (for home healthcare) specified in the following table. The customer or the user of the Index BPM should assure that it is used in such an environment.

**Manufacturer's declaration-electromagnetic immunity test specifications for ENCLOSURE PORT IMMUNITY to RF wireless communications equipment**

Test frequency (MHz)	Band (MHz)	Service	Modulation	Maximum power (W)	Distance (m)	IMMUNITY TEST LEVEL (V/m)	Compliance level (V/m for home healthcare)
385	380-390	TETRA 400	Pulse modulation 18 Hz	1,8	0,3	27	27
450	430-470	GMRS 460, FRS 460	FM <sup>4</sup> ±5 kHz deviation 1kHz sine	2	0,3	28	28
710	704-470	LTE Band 13,17	Pulse modulation 217 Hz	0,2	0,3	9	9
745							
780							
810	800-960	GSM 800/900 TETRA 800 iDEN 820 CDMA 850 LTE Band 5	pulse modulation 18 Hz	2	0,3	28	28
870							
930							

<sup>4</sup> As an alternative to FM modulation, 50% pulse modulation at 18 Hz may be used because while it does not represent actual modulation, it would be worst case.



Test frequency (MHz)	Band (MHz)	Service	Modulation	Maximum power (W)	Distance (m)	IMMUNITY TEST LEVEL (V/m)	Compliance level (V/m for home healthcare)
1 720	1 700-1 990	GSM 1800 CDMA 1900 GSM 1900 DECT LTE Band 1, 2, 3, 4, 25 UMTS	Pulse modulation 217 Hz	2	0,3	28	28
1 845							
1 970							
2 450	2 400-2 570	Bluetooth, WLAN, 802.11 b/g/n, RFID, 2450, LTE Band 7	Pulse modulation 217 Hz	2	0,3	28	28
5 240	5 100-5 800	WLAN 802.11 a/n	Pulse modulation 217 Hz	0,2	0,3	9	9
5 500							
5 785							

**NOTE:** If necessary to achieve the IMMUNITY TEST LEVEL, the distance between the transmitting antenna and the ME EQUIPMENT or ME SYSTEM may be reduced to 1 m. The 1 m test distance is permitted by IEC 61000-4-3.

**NOTE:** For some services, only the uplink frequencies are included.

**NOTE:** The carrier shall be modulated using a 50% duty cycle square wave signal.

## Maintenance

- No firmware update is needed during the service life of this product.
- On very rare occasions, you might need to reinstall the firmware on the device due to hardware malfunction. In this case, the intended use remains unchanged.
- Any modification or change to the firmware is prohibited.



