



Model

ECD4224EGG - ECD4224EGW

Tumble Dryer

INSTRUCTION MANUAL

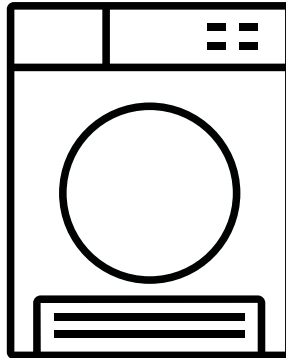

BEFORE USE, PLEASE READ AND FOLLOW ALL SAFETY RULES AND OPERATING INSTRUCTIONS.

Address :

Phone number :







Fax :



Thank you for choosing this product.

This User Manual contains important safety information and instructions on the operation and maintenance of your appliance.

Please take the time to read this User Manual before using your appliance and keep this book for future reference.

Icon	Caption	Description
	WARNING	Risk of serious injury or death
	RISK OF ELECTRIC SHOCK	Dangerous voltage
	FIRE	Risk of fire
	ATTENTION	Risk of injury or material damage
	IMPORTANT/NOTE	Information on correct operation of the system
		Read the instructions.
		Hot surface

CONTENTS

Help Us Help You	V
1. QUICK START	VI
2. SAFETY INSTRUCTIONS	3
2.1. Electrical Safety	3
2.2. Important Safety Instructions	4
2.3. Grounding Instructions	5
2.4. Children's Safety	6
2.5. Product Safety	7
2.6. Correct Use	8
2.7. Installing On Top Of a Washing Machine.....	9
3. INSTALLATION INSTRUCTIONS.....	11
3.1. Connection to Water Outlet (with optional drain hose)	11
3.1.1. Connecting the Water Discharge Hose	12
3.2. Electrical Connection.....	12
3.3. Electric Installation.....	12
3.4. Electrical Connection.....	12
3.5. 4-Wire Power Supply Cord Connection.....	13
3.6. 3-Wire Power Supply Cord Connection.....	14
3.7. Under Counter Installation.....	16
3.8. Adjusting the Adjustable Feet	16
3.9. Positioning the Machine on the Ground	16
4. OPERATING INSTRUCTIONS	17
4.1. OVERVIEW	17
4.2. PREPARING THE LAUNDRY	18
4.2.1. Sorting the Laundry to be Dried.....	18
4.3. Preparing the Laundry to be Dried	19
4.4. Load Capacity.....	19
4.5. USING THE TUMBLE DRYER	20
4.6. Control Panel.....	20
4.7. Program Selection and Consumption Table	21
4.7.1. Auxiliary Functions.....	22
4.7.2. Starting the Program	23
4.7.3. Selection Stand By	24
4.8. Drum Light Information	24

5. CLEANING AND CARE	26
5.1. Cleaning the Lint Filter.....	26
5.2. Emptying the Water Tank.....	26
5.3. Cleaning the Condenser.....	27
5.4. Cleaning the Humidity Sensor	27
5.5. Cleaning the Inner Surface of the Loading Door	28
6. TECHNICAL SPECIFICATIONS.....	29
7. TROUBLESHOOTING	30
8. AUTOMATIC FAULT WARNINGS AND WHAT TO DO.....	32
9. PRODUCT WARRANTY	33
10. ENVIRONMENTAL PROTECTION AND PACKAGING INFORMATION	34
10.1. Packaging Information.....	34
10.2. Energy Efficiency.....	34

1. QUICK START

Please check the user manual for detailed information.



- 1** Separate your clothes according to their types, place into the machine and close the door.

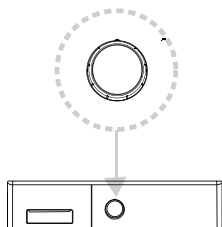

- 2** Select the suitable program for your laundry by rotating the adjustment knob.

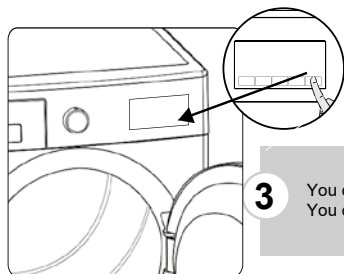

- 3** You can select additional functions for drying.
You can run the program by pushing Start / Pause button.

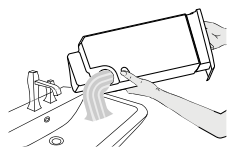

- 4** After the drying program is completed, the water tank must be emptied.
*** Please check the user manual for detailed information.

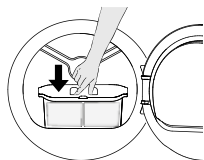

- 5** After the drying program is completed, the filter must be cleaned.
*** Please check the user manual for detailed information.

PRIMARY CONSIDERATIONS

- This appliance can be used by children aged from 8 years and above and persons with reduced physical, sensory or mental capabilities or lack of experience and knowledge if they have been given supervision or instruction concerning use of the appliance in a safe way and understand the hazards involved. Children must not play with the appliance. Cleaning and user maintenance must not be made by children without supervision.
- Children of less than 3 years should be kept away unless continuously supervised.
- This tumble dryer is intended only for household and indoor use. The warranty will be void in case of commercial use.
- Use this product only for laundry with a label that indicates it is suitable for drying.
- The manufacturer will not accept responsibility for damages resulting from incorrect use or transport.
- Do not allow floor coverings to obstruct the ventilation openings.
- Installation and repair of the machine should only be made by an authorised repair agent. The manufacturer cannot be held responsible for damages resulting from un-authorised repairs.

⚠ WARNING: Never spray or pour water onto the dryer to wash it! There is risk of electric shock!

- Leave at least 3 cm of space between the side and rear walls of the product and above if you plan on placing your appliance under a worktop.
- Assembly / disassembly for under-counter installation if necessary must be done by an authorised service agent.
- Before installation, check the product for visible damage. Never install or operate a damaged product.

- Keep pets away from the dryer.
- Fabric softeners, or similar products, should be used in accordance with the manufacturers instructions.
- Remove all objects from pockets such as lighters and matches.
- The appliance must not be installed behind a lockable door, a sliding door or a door with a hinge on the opposite side to that of the tumble dryer, if it prevents the door from being fully opened.

 WARNING:

- Do not put any living thing in your machine for any purpose.
- Condensation water which accumulates in the water tank, may contain external particles such as detergent residue, laundry thread, and lint. For this reason, the water accumulated in the water tank should not be used for any purpose.
- Opening the door before the cooling process is finished may cause you to contact with hot air.
- Opening the door before the cooling process is finished may cause a contact with hot air.
- Do not take the laundry out of the machine before the program ends.
- Blocking the airflow can reduce the machine's performance.

2. SAFETY INSTRUCTIONS

This section contains safety instructions that will help protect you from risk of personal injury or property damage. Failure to follow these instructions will void any warranty.

2.1. Electrical Safety

- The appliance must not be supplied through an external switching device, such as a timer, or connected to a circuit that is regularly switched on and off by a utility.
- Do not touch the power plug with wet hands. Always pull the plug to unplug the product, otherwise, there will be risk of an electric shock.
- Connect the dryer to a grounded socket with fuse protection. Have the earth connection installed by a qualified electrician. Our company cannot be held responsible for damages/losses resulting from using the dryer without an earth connection as required by local regulations.
- The voltage and the allowable fuse protection are indicated on the type plate. **(For the type plate, please see Overview)**
- Voltage and frequency values indicated on the type plate must be equal to the mains voltage and frequency value in your house.
- Unplug the dryer when it is not used for an extended period, and before installation, maintenance, cleaning and repair, otherwise, the dryer may get damaged.
- The plug socket must be freely accessible at all times after installation.

 A damaged power cord/plug can cause fire or give you an electric shock. When damaged it must be replaced, this should only be done by qualified personnel.

 To avoid the risk of fire or electric shock, do not use extension cords, multi sockets or adapters to connect the dryer to mains power.

2.2. Important Safety Instructions

WARNING - To reduce the risk of fire, electric shock, or injury to persons when using your appliance, follow basic precautions, including the following:

- Read all instructions before using the appliance.
- Do not dry articles that have been previously cleaned in, washed in, soaked in, or spotted with gasoline, dry-cleaning solvents, or other flammable or explosive substances, as they give off vapours that could ignite or explode.
- Do not allow children to play on or in the appliance. Close supervision of children is necessary when the appliance is used near children.
- Before the appliance is removed from service or discarded, remove the door to the drying compartment.
- Do not reach into the appliance if the drum is moving.
- Do not install or store this appliance where it will be exposed to the weather.
- Do not tamper with controls.
- Do not repair or replace any part of the appliance or attempt any servicing unless specifically recommended in the user-maintenance instructions or in published user-repair instructions that you understand and have the skills to carry out.

- Do not use fabric softeners or products to eliminate static unless recommended by the manufacturer of the fabric softener or product.
- Do not use heat to dry articles containing foam rubber or similarly textured rubber-like materials.
- Clean lint screen before or after each load.
- Keep area around the exhaust opening and adjacent surrounding areas free from the accumulation of lint, dust, and dirt.
- The interior of the appliance and exhaust duct should be cleaned periodically by qualified service personnel.
- Do not place items exposed to cooking oils in your dryer. Items contaminated with cooking oils may contribute to a chemical reaction that could cause a load to catch fire. To reduce the risk of fire due to contaminated loads, the final part of a tumble dryer cycle occurs without heat (cool down period). Avoid stopping a tumble dryer before the end of the drying cycle unless all items are quickly removed and spread out so that the heat is dissipated.

SAVE THESE INSTRUCTIONS

 **CALIFORNIA WARNING** This product can expose you to chemicals including Lead and Di-n-butyl Phthalate (DBP), which is known to the State of California to cause developmental and reproductive toxicity. For more information go to www.P65Warnings.ca.gov

2.3. Grounding Instructions

- This appliance must be grounded. In the event of malfunction or breakdown, grounding will reduce the risk of electric shock by providing a path of

least resistance for electric current. This appliance is equipped with a cord having an equipment-grounding conductor and a grounding plug. The plug must be plugged into an appropriate outlet that is properly installed and grounded in accordance with all local codes and ordinances.

- **⚠️ WARNING:** Improper connection of the equipment-grounding conductor can result in a risk of electric shock. Check with a qualified electrician or service representative or personnel if you are in doubt as to whether the appliance is properly grounded.
- Do not modify the plug provided with the appliance: if it will not fit the outlet, have a proper outlet installed by a qualified electrician.

2.4. Children's Safety

- This appliance is not intended for use by persons (including children) with reduced physical, sensory or mental capabilities, or lack of experience and knowledge, unless they have been given supervision or instruction concerning use of the appliance by a person responsible for their safety.
- This appliance can be used by children aged from 8 years and above and persons with reduced physical, sensory or mental capabilities or lack of experience and knowledge if they have been given supervision or instruction concerning use of the appliance in a safe way and understand the hazards involved. Children must not play with the appliance. Cleaning and user maintenance must not be made by children without supervision.
- Do not leave children unattended near the machine.
- Children might lock themselves in the machine resulting in risk of death.
- Do not allow children to touch the glass door during operation. The surface becomes extremely hot and

- may cause skin damage.
- Keep packaging material away from children.
 - Poisoning and irritation may occur if detergent and cleaning materials are consumed or come into contact with the skin and eyes.
 - Keep cleaning materials out of the reach of children
- Electrical products are dangerous for children.
- Keep children away from the product while it is running.
 - To prevent children from interrupting the dryer cycle, you can use the child lock to avoid any changes in the running program.
 - Do not allow children to sit/climb on or climb inside the product.

2.5. Product Safety

 **Due to risk of fire, the following laundry items and products should NEVER be dried in the dryer:**

- Do not dry unwashed items in the tumble dryer.
- Items that have been soiled with substances such as cooking oil, acetone, alcohol, petrol, kerosene, spot removers, turpentine, waxes and wax removers should be washed in hot water with an extra amount of detergent before being dried in the tumble dryer.
- Cleaning cloths and mats that have residues of flammable cleaning agents or acetone, gas, petrol, stain remover, turpentine, candle, wax, wax remover or chemicals.
- Laundry that has residues of hair sprays, nail polish remover and similar substances.
- Laundry on which industrial chemicals have been used for cleaning (such as chemical cleaning).
- Laundry that has any kind of foam, sponge, rubber or rubber-like parts or accessories. These include latex foam sponge, shower caps, waterproof

fabrics, fitted clothes and foam pillows.

- Items with filling and damaged items (pillows or jackets). Foam protruding from these items might catch fire during the drying process.
- Operating the dryer in environments that contain flour or coal dust may cause explosion.

⚠ ATTENTION: Underwear that contains metal reinforcements should not be put in the dryer. The dryer may be damaged if metal reinforcements come loose and break off during drying.

2.6. Correct Use

⚠ ATTENTION: Never stop a tumble dryer before the end of the drying cycle unless all items are quickly removed and spread out so that the heat is dissipated.

⚠ ATTENTION: Make sure that pets do not enter the dryer. Check the inside of the dryer before using it.

⚠ ATTENTION: Super heating of clothes inside of the dryer can occur if you cancel the program or in the event of a power failure whilst the dryer is running. This concentration of heat can cause self-combustion so always activate the Refresh program to cool down or quickly remove all laundry from the dryer in order to hang them up and dissipate the heat.

- Use the dryer only for household drying and to dry fabrics with a label that indicates they are suitable for drying. All other uses are out of the scope of intended use and are prohibited.
- The warranty will be void in case of any commercial use.
- This appliance is designed to be used inside domestic residences only, and should be placed on a straight and stable surface.

- Do not lean against or sit on the door of the dryer. The dryer may tip over.
- To maintain a temperature that will not harm the laundry (e.g. to prevent the laundry from catching fire), a cooling process starts after the heating process. After this, the program ends. At the end of the program, always remove the laundry promptly.

 **ATTENTION:** Never use the dryer without a lint filter or with a damaged lint filter.

- Lint filters must be cleaned **after each use** as indicated in **Cleaning the Lint Filter**.
- Lint filters must be dried after wet cleaning. Wet filters might cause malfunction during the drying process.
- Lint accumulation must not to be allowed around the tumble dryer (not applicable for appliances intended to be vented to the exterior of the building)

 **IMPORTANT:** The clearance between the dryer and the floor should not be reduced with objects such as carpets, wood or panel, otherwise, sufficient air intake cannot be ensured for the machine.

- Do not install the dryer in rooms where there is risk of freezing. Freezing temperatures negatively affect the dryers performance. Condensation that freezes in the pump and hose may cause damage.

2.7. Installing On Top Of a Washing Machine

 **ATTENTION:** A washing machine cannot be placed on the dryer. Pay attention to the warnings below when installing the dryer on a washing machine.

 **ATTENTION:** The dryer can only be placed on washing machines that have same capacity and above.

- To use the dryer on the washing machine, a fixing part must be used between the two products. The fixing part must be attached by an Authorised Service Provider.
- When the dryer is placed on the washing machine, the total weight of these products may reach almost 330 lbs (when loaded). Place the products on a solid floor that has a load bearing capacity!

Appropriate Installation Table for Washing Machine and Tumble Dryer					
Tumble Dryer (Depth)	Washing Machine				
	37-41 cm 14.5-16.1 inch	42-45 cm 16-17.7 inch	46-49 cm 18.1-19.2 inch	50-56 cm 19.6- 22 inch	57-63 cm 22.4-24.8 inch
52,5 cm / 20.6 inch	X	✓	✓	✓	✓
56 cm / 22 inch	X	X	✓	✓	✓
61 cm / 24 inch	X	X	X	✓	✓
64 cm / 25.1 inch	X	X	X	X	✓

(For the depth information, please see 7. Technical Specifications)

In order to put the dryer machine onto the washing machine, a special stacking kit is required as an optional extra. Please contact customer service to acquire. The assembly instruction will be served together with the stacking kit.

CE Declaration of conformity

We declare that our products meet the applicable European Directives, Decisions and Regulations and the requirements listed in the standards referenced.

Disposing the Old Product



The symbol on the product or on its packaging indicates that this product may not be treated as household waste. Instead it shall be handed over to the applicable collection point for the recycling of electrical and electronic equipment. By ensuring this product is disposed of correctly, you will help prevent potential negative consequences for the environment and human health, which could otherwise be caused by inappropriate waste handling of this product. For more detailed information about recycling of this product, please contact your local city office, your household waste disposal service or the shop where you purchased the product.

3. INSTALLATION INSTRUCTIONS

Install the clothes dryer according to the manufacturer's instructions and local codes.

⚠ WARNING Risk of Fire

"Clothes dryer installation must be performed by a qualified installer."

"Do not install a clothes dryer with flexible plastic venting materials. If flexible metal (foil type) duct is installed, it must be of a specific type identified by the appliance manufacturer as suitable for use with clothes dryers. Flexible venting materials are known to collapse, be easily crushed, and trap lint. These conditions will obstruct clothes dryer airflow and increase the risk of fire."

"To reduce the risk of severe injury or death, follow all installation instructions."

"Save these instructions."

- Before contacting the local Authorised Service Provider for the installation of the dryer, check the information in the user manual to make sure that the electrical installation and water outlet is suitable. If they are not, call a qualified electrician and a plumber to have the necessary adjustments made.
- It is the customer's responsibility to prepare the dryer's installation place, as well as the electricity and waste water installation. Before installation, check the dryer for damage. If damaged, do not have it installed. Damaged products may endanger your health.
- Install the dryer on a stable and flat surface.
- Run the dryer in a dust-free environment where the air ventilation is good.
- The clearance between the dryer and the floor **should not be** reduced with objects such as carpets, wood or tape.
- **Do not block the ventilation grills** found on the plinth of the tumble dryer.
- The appliance must not be installed behind a lockable door, a sliding door or a door with a hinge on the opposite side of the tumble dryer, in such a way that blocks the full opening of the tumble dryer door.
- Once the dryer has been installed, the connections must remain stable. When installing the dryer, make sure that the rear surface is not leaning on anything (e.g. tap, socket).

- The operating temperature of the dryer is +5°C to +35°C. If operated out of this temperature range, the performance of the dryer will be affected negatively and the product will be damaged.
- Be careful when carrying the product since it is heavy. Always wear safety gloves.
- Always install the product should be placed against a wall.
- The rear surface of the product should be placed against the wall.
- When the product is placed on a stable surface, use a water level to check if it is fully stable. If not, adjust the feet until it becomes steady. Repeat this process every time you relocate the product.
- Do not place the dryer onto the power cable.
- Install the clothes dryer according to the manufacturer's instructions and local codes

3.1. Connection to Water Outlet (with optional drain hose)

In products with a condenser unit, water accumulates in the water tank during the drying process. You must empty the accumulated water **after each drying process**. Instead of periodically emptying the water tank, you can also use the water drain hose provided with the product to directly drain the water outside.

3.1.1. Connecting the Water Discharge Hose

1. Pull and take out the end of the hose at the back of the dryer. Do not use any tools to take out the hose.
2. Fit one end of the water discharge hose, which is provided with the product, to the slot from which you have removed the hose.
3. Fix the other end of the water discharge hose directly to the water outlet or sink.

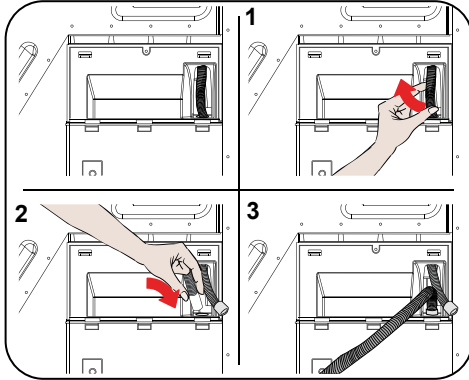

⚠ ATTENTION: The hose must be connected in a manner that it cannot be displaced. If the hose comes out during water discharge, there might be flooding in your house.

🚫 IMPORTANT: The water discharge house must be installed at a height of 80 cm maximum.

🚫 IMPORTANT: The water discharge hose must not be bent between the outlet and the product, folded or stepped over.

3.2. Electrical Connection

⚠ ATTENTION: There is risk of fire and electric shock.

- Your dryer is set to 208-240 V and 60 Hz.
- The mains cable of the dryer is equipped with a special plug. This plug must be connected to an earthed socket protected by a fuse of 16 Amperes as indicated on the type plate. The fuse current rating of the power line where the outlet is connected must also be 16 amperes. Consult a qualified electrician if you do not have such an outlet or fuse.
- Our company cannot be held responsible for damages resulting from usage without earthing.

🚫 IMPORTANT: Operating your machine at low voltage values will shorten the service life and decrease the performance of your machine.

3.3. Electric Installation

- The clothes dryer installation must be performed by a qualified installer.
- Install the appliance according to the manufacturer's instructions and local codes.
- To reduce the risk of severe injury or death, follow all installation instructions.
- If local codes do not permit the 3-wire power supply cord connection, only 4-wire power supply cord must be used.
- Do not use an extension cord.

3.4. Electrical Connection

Before you start, select your receptacle type.

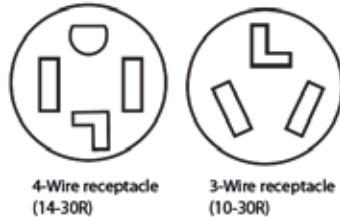

- If you have 4-wire receptacle, you must use UL listed NEMA 14-30P 240V / 30A 4-wire supply cord with ring terminals or spade terminals with upturned ends. Supply cord must be type SRDT and at least 5 ft. length.
- If you have 3-wire receptacle, you must use UL listed NEMA 10-30P 240V / 30A 3 wire supply cord with ring terminals or spade terminals with upturned ends. Supply cord must be type SRDT and at least 5 ft. length.

3.5. 4-Wire Power Supply Cord Connection

⚠ WARNING

- Before the connection, disconnect the power.
- Use UL listed 240V / 30A power supply cord.

Your dryer was equipped with strain relief. Use this strain relief in connection.

1. Remove the screw and terminal box cover.

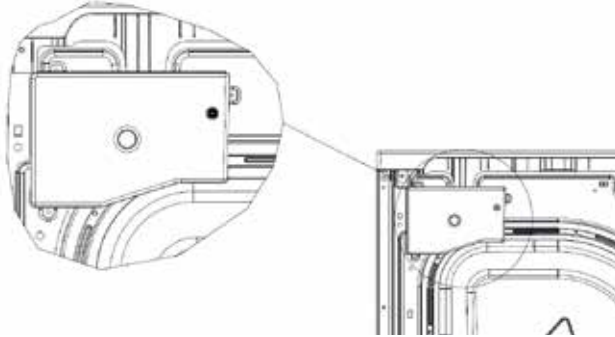

2. Remove the clamp of the strain relief which has already attached on your machine. Then pass the clamp through the supply cord and put the supply cord through the main body of the strain relief. Be sure that wire insulation of the cord inside the strain relief.



3. Remove the terminal block screws which are indicated by A and grounding screw which is indicated by B. Neutral ground conductor (central terminal) is provided in the dryer as a closed loop.

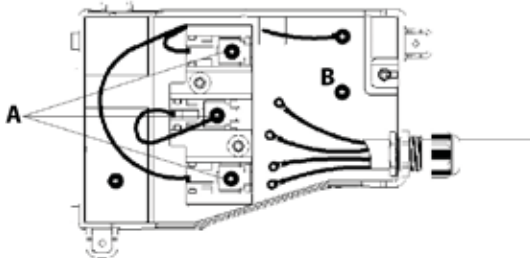

4. Connect the ground conductor (green wire) under the terminal B. Then connect the neutral wire (white wire) to center of the terminal. Neutral ground conductor of the dryer should remain on the center terminal. Be sure that neutral ground conductor of dryer and neutral wire of supply cord connected to center terminal together. Tighten all screws.

5. Connect remaining wires under the outer terminals of the block and tighten all screws. After every connection is completed, tighten strain relief clamp in order to secure the supply cord. Finally, cover up the box cover.

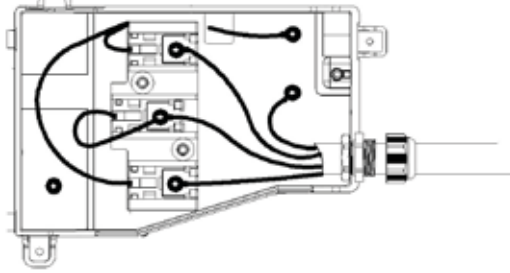

3.6. 3-Wire Power Supply Cord Connection

⚠ WARNING

- Before the connection, disconnect the power.
- Use UL listed 240V / 30A power supply cord.

Your dryer was equipped with strain relief. Use this strain relief in connection.

1. Remove the screw and terminal box cover.

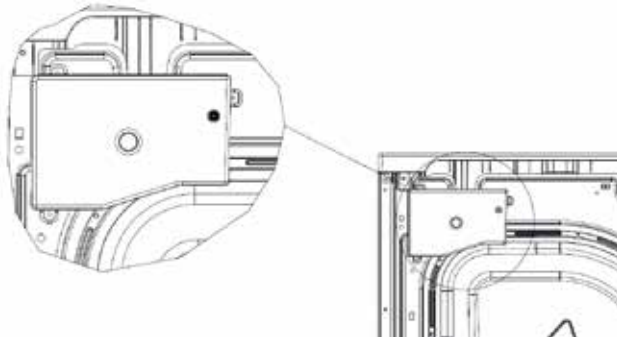

2. Remove the clamp of the strain relief which has already attached on your machine. Then pass the clamp through the supply cord and put the supply cord through the main body of the strain relief. Be sure that wire insulation of the cord inside the strain relief.



3. Remove the terminal block screws which are indicated by A and grounding screw which is indicated by B. Neutral ground conductor (central terminal) is provided in the dryer as a closed loop.

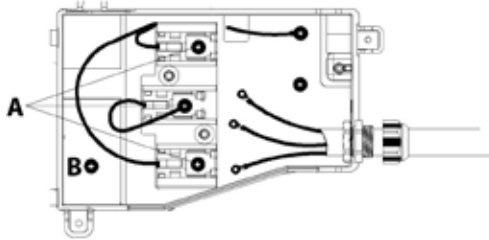

4. Remove the neutral ground conductor from central terminal and connect the neutral wire of the supply cord under the central terminal of the block. Tighten the screw.

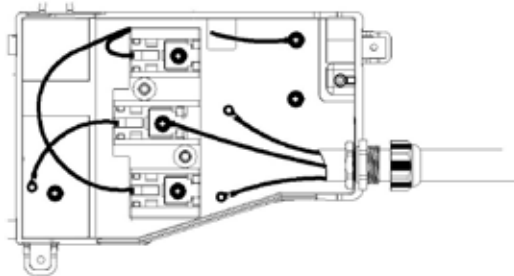

5. Connect the neutral ground conductor under the screw B. Then connect the remaining supply cord wires under the outer terminals of the block. Tighten all screws. After every connection is completed, tighten strain relief clamp in order to secure the supply cord. Finally, cover up the box cover.

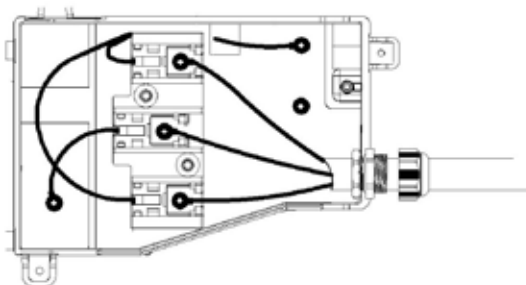

3.7. Under Counter Installation

- Leave at least 3 cm of space between the side and rear walls of the product and the underside of the worktop when installing your product under a counter.
- Assembly / disassembly under the counter if necessary must be done by authorized service.

3.8. Adjusting the Adjustable Feet

- In order for the dryer to operate more quietly and without vibration, it must stand on its feet properly and in balance. Make this balance by adjusting the feet.
- Adjust by turning the feet to the right and left until the dryer stands level and balanced.
- Product should not be placed on sloping, uneven and crooked floors.

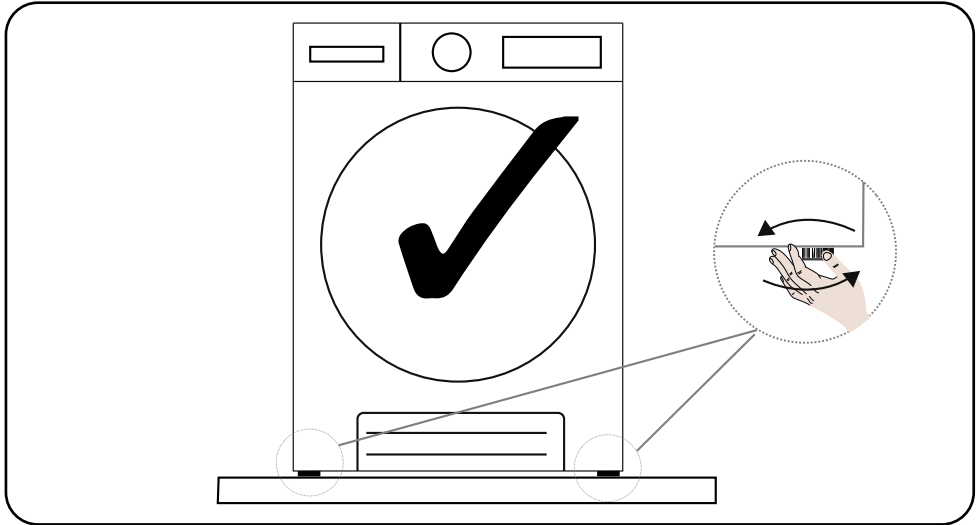

3.9. Positioning the Machine on the Ground

The tumble dryer must be positioned on a flat surface. It should not be placed on sloping, angled floors.

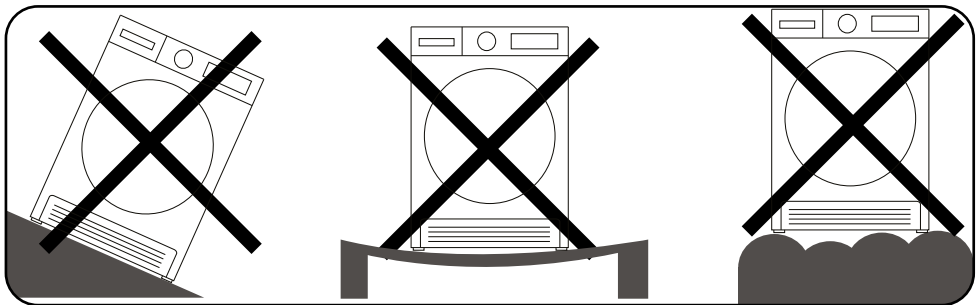

4. OPERATING INSTRUCTIONS

! WARNING: To reduce the risk of fire, electric shock, or injury to persons, read the IMPORTANT SAFETY INSTRUCTIONS before operating this appliance.

4.1. OVERVIEW

Shown visual is representative and is for informational purposes only on parts of the device. Parts may differ depending on the device model.

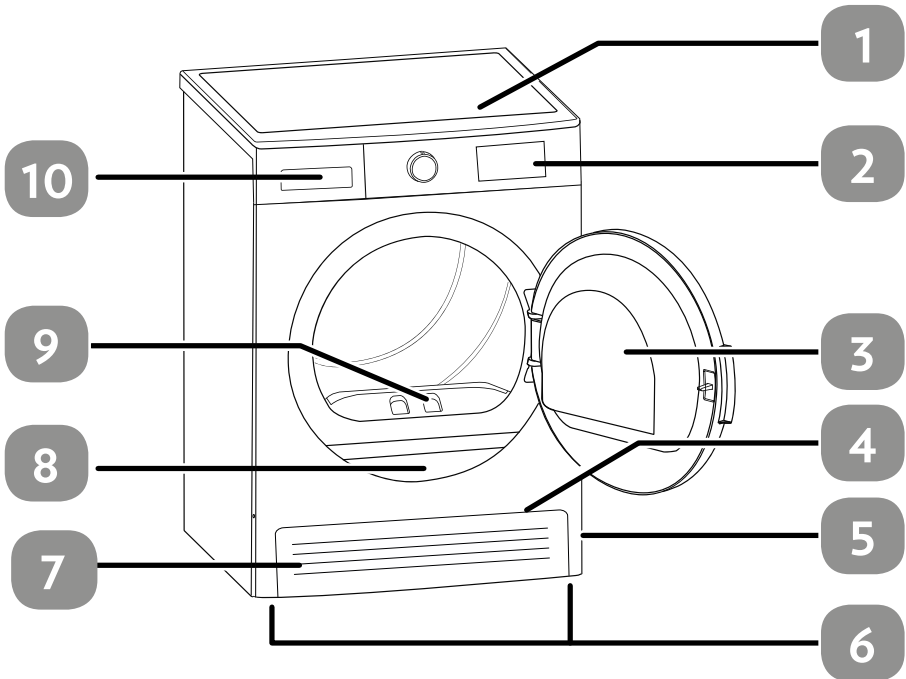

















1. Upper tray
2. Control panel
3. Loading door
4. Ventilation grills
5. Plinth opening slot
6. Adjustable feet
7. Plinth
8. Type plate
9. Lint filter
10. Drawer Cover

4.2. PREPARING THE LAUNDRY

4.2.1. Sorting the Laundry to be Dried

Follow the instructions on the labels of the laundry to be dried. Only dry items that have a statement/symbol that indicates "they can be dried in a dryer".

- Do not operate the product with load amounts and laundry types other than those given in 4.3. Load Capacity.

 Suitable for drying in a dryer	 Does not need ironing	 Sensitive/Delicate drying	 Not suitable for drying in a dryer
 No drying	 Do not dry-clean	 At any temperature	 At high temperatures
 At medium temperatures	 At low temperatures	 Heatless	 Hang to dry
 Spread to dry	 Hang wet to dry	 Spread in shadow to dry	 Suitable for dry cleaning

Do not dry thin, multi-layer or thick-layer fabrics together as they dry at different levels. For this reason, dry clothes together that have the same structure and fabric type. This way, you can get an even drying result. If you think that the laundry is still wet, you can select a time program for additional drying.

Please dry your big (like duvets) and small sizes of laundries separately in order to not to have a damp laundries.

 **IMPORTANT:** Delicate fabrics, embroidered fabrics, woolen/silk fabrics, clothes made of delicate and expensive fabrics, airtight clothes and tulle curtains are not suitable for drying in the dryer.

4.3. Preparing the Laundry to be Dried

Risk of explosion and fire!

Remove all objects from pockets such as lighters and matches.

 **ATTENTION:** The drum of the dryer and the fabrics may get damaged.

- The clothes may have become entangled during the washing process. Separate them from each other before placing them in the dryer.
- Remove all objects in the pockets of the clothes and apply the following:
- Tie fabric belts, apron laces etc. to each other or use a laundry bag.
- Lock the zips, clasps and fasteners, do up the buttons of covers.
- To get the best drying result, sort the laundry according to the textile type and drying program.
- Remove clips and similar metal parts from the clothes.
- Woven goods such as t-shirts and knit clothes **generally shrink in the first drying**. Use a protective program.
- **Do not over-dry synthetics. This will cause creases.**
- When washing the laundry to be dried, adjust the amount of softener according to the data from the manufacturer of the washing machine.

4.4. Load Capacity

Follow the instructions in the "Program selection and consumption table". (**See: 5.2 Program selection and consumption table**). Do not load the product with more laundry than the capacity values specified in the table.

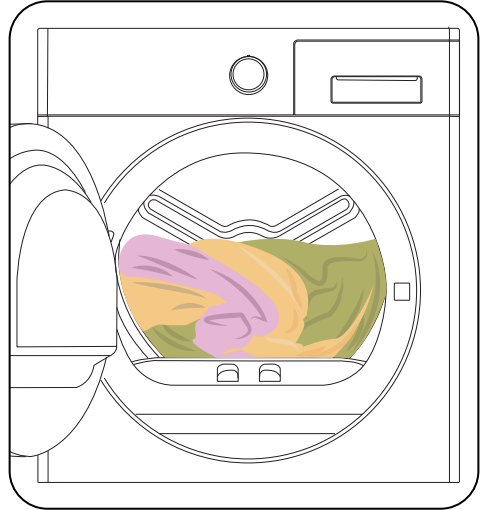

 **IMPORTANT:** It is not recommended to load the dryer with more laundry than the amount shown in the figure. When overloaded, the drying performance of the dryer will decrease and the dryer and laundry might be damaged.

4.5. USING THE TUMBLE DRYER

4.6. Control Panel

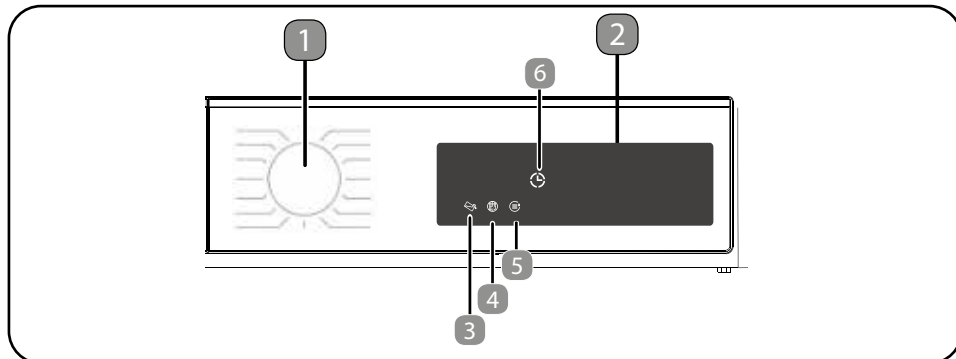

1. Program Selection Knob

- Use the program selection knob to select the desired drying program

2. Electronic Indicator and Display

Symbol	Symbol Meaning	Symbol	Symbol Meaning
	Water tank warning indicator		Delay Timer
	Lint filter cleaning warning indicator		Anti-crease 60'
	Condenser cleaning warning indicator		Anti-crease 120'
	Delay start indicator		Buzzer Cancel
	Delicate		

Drying Step Display:			
	Drying		Cupboard dry
	Iron dry		End
<p>The electronic display shows the drying steps throughout the program. Every time a program step starts, the relevant drying step light turns on. Once the drying step is complete, the relevant drying step light turns off.</p>			
Energy Consumption Display			
<p>The energy consumption display shows the energy consumption of the selected program. The bigger the display, the more the energy consumption. The energy consumption level increases or decreases depending on the fabric type, duration of the selected program, the drying level and the spinning speed.</p>			

4.7. Program Selection and Consumption Table

Press the Start/Pause button to start the program. The Start/Pause LED that indicates that the program has started and the Drying LED will come on.

Program	Load (kg/lb)	Washing machine spin speed	Approximate amount of remaining humidity	Duration (minutes)
Normal + Regular Dry	9/19,8	1000	60%	158
Outdoor	2/4,4	800	40%	43
Towels	3/6,6	1000	60%	71
Mix	4/8,8	1000	60%	81
Warm Refresh	-	-	-	-
Air Fluff	-	-	-	-
Time Drying	-	-	-	-
Sanitize	3/6,6	1000	60%	59
Baby Care	3/6,6	1000	60%	68
Delicates	2/4,4	600	50%	41
Perm Press + Regular Dry	4,5/9,9	800	40%	61
Bedding	2,5/5,5	800	60%	127
Sports Wear	4/8,8	800	40%	53
Express 29'	2/4,4	1200	50%	29
Shirts 12'	0,5/1,1	1200	50%	12

Normal cycle was used to rate the dryer for energy efficiency. The normal cycle defaults to regular drying level and high temperature setting.

This product meets the ENERGY STAR® guidelines for energy efficiency.

Cycles with the low heat setting save the most energy. Use the low heat setting for auto dry cycles without any level adjust to save on energy and prevent over drying your clothing.

4.7.1. Auxiliary Functions

The table that summarises the options that can be selected in programs is given below.

Option	Description
Drying Level	"Select the drying target suitable for your laundry to be dried. Select Extra Dry for thick and multilayer laundry that takes time to dry. Select Regular Dry for regular, single-layer laundry. Select Damp Dry for laundry that you wish to leave damp, ready for ironing."
Level Adjust	The dampness level obtained after drying can be increased by another 3 levels in addition to the standard setting. This way, it is ensured that the laundry is drier. Levels that can be selected apart from the standard setting +1 (low), +2 (medium), +3 (high). After selection, light of the relevant drying level turns on.
Delicate Drying	Delicate fabrics are dried in a longer time at low temperatures.
Delayed Start	You can delay the start of the program by selecting a time between 1 and 23 hours. You can press Start/Pause to activate the desired delay time. When this time is up, the selected program will start automatically. During the delay time, options compatible with the program can be activated/deactivated. If you long press the Delayed Start button, the delay time will change continuously.
Cancel Audible Warning	The drying machine will give an audio warning when the buttons are pressed, when the program selection knob is turned and when the program ends. To cancel audio warnings, press and hold the "Anti-Crease Option" for 3 seconds. When you press this button, you will hear an audible warning that indicates that the option has been activated and the audible warnings stated will be cancelled.
Time Drying	If the program knob is turned to Time Drying, you can press the Time Drying option button to select it and press Start/Pause to start the program.
Child Lock	There is a child lock option to avoid changes in the program flow when keys are pressed during the program. To activate child lock feature user should press "Options" and "Anticrease" buttons simultaneously for 3 sec. When the child lock activated, all keys will be deactivated. Child lock is not automatically deactivated at the end of the program. To deactivate child lock at end of the program, set the program selection knob to "Off" position. Then program selection knob to first position. Child lock is still active. To deactivate the child lock, user should press "Options" and "Anticrease" buttons simultaneously for 3 sec. When activating/deactivating the child lock, "CL" will visualize on display for 2 sec and then becomes off; and an audible warning will be heard. Warning: When the product is running or the child lock is active, if you turn the program selection knob, you will hear an audible warning and "CL" will visualize on display for 2 sec and then becomes off. If you turn the program selection knob, you will hear an audible warning. Even if you set the program knob to another program, the previous program will continue running. To select a new program, you need to deactivate the child lock and then set the program selection knob.
Anti-wrinkle*	If you do not open the door of the machine at the end of the program, the anti-crease option will be active for 60 minutes except normal program. When the anti-crease option is selected, anti-crease will be active for 120 minutes.
Temperature Level	For the laundry to be dried, temperature level can be adjusted with low, medium and high options.
*Options vary depending on model.	

4.7.2. Starting the Program

The Start/Pause LED will flash during program selection. Press the Start/Pause button to start the program. The Start/Pause LED that indicates that the program has started and the drying LED will come on.

Program	Description
Normal + Regular Dry	This program dries cotton laundry including bedsheets, pillowcases, pyjamas, underwear, tablecloths etc.
Outdoor	This program is suitable for outdoor clothing, waterproof jackets, jackets with inner insulation, etc.
Towels	This program dries thick cotton laundry such as towels, bathrobe, etc.
Mix	This program dries cotton-synthetic mixed garments that do not discolour to make them ready to wear.
Warm Refresh	Warm refresh helps wool textiles to remove excess water after washing by applying low temperature and gentle movements of drum.
Air Fluff	Time drying option is selected from 10 minutes to 150 minutes without providing hot air, refresh is done and bad odors can be eliminated.
Time Drying	To reach the required drying level at a low temperature, you can use the time programs of 10 min. to 1 min. Regardless of the drying level, the program stops at the desired time.
Sanitize	This program is suitable for the fabrics which need hygiene requirements.
Baby Care	This program provides hygienic drying for delicate infant clothes at a low temperature.
Delicates	This program dries thin clothes like shirts, blouses and silk garments at a low temperature to make them ready to wear.
Perm Press + Regular Dry	This program dries synthetics, such as shirts, t-shirts, blouses, at a lower temperature compared to the cottons program.
Bedding	This program is used to dry single duvet with feather, down or synthetic fillings.
Sports Wear	Sport program is used for synthetic sport laundries like shorts, t-shirts at low temperature.
Express 29'	2 kg of cotton shirts spun at a high speed in the washing machine are dried in 29 minutes.
Shirts 12'	2 to 3 shirts are ready for to be ironed in 12 minutes.

 **IMPORTANT:** Do not open the loading door while the program is running. If you have to open the door, do not keep it open for a long time.

4.7.3. Selection Stand By

“After 15 minutes without user action in selection mode, machine goes to energy-saving mode due to decrease energy consumption. No led activation on display. When we changed the knob position in energy-saving mode the jog dial led should be fix on in every knob change and nothing is shown in display.

To restart the machine it will be necessary to move selector to OFF and select again the program.

During the Program

If you open the door when the program is running, the product will switch to standby mode. Once the door has been closed, press the Start/Pause key to resume the program.

Do not open the loading door when the program is running. If you have to open the door, do not keep it open for a long time.

Program End

Once the program is over, the warning LEDs for Start/Pause, water tank level, filter cleaning and condenser cleaning will turn on. Additionally, an audible warning will be given at the end of the program. You can remove the laundry to make the machine ready for a new load.

 **IMPORTANT:** Clean the lint filter after every program. Empty the water tank after every program.

 **IMPORTANT:** If you do not take out the laundry after the program has ended, the 1-hour Anti Crease phase will automatically be activated. This program rotates the drum at regular intervals to prevent creases.

4.8. Drum Light Information

- This product includes LED Drum Light. The light works automatically when you open the door. And closes itself after awhile automatically.

- It is not an adjustable option for user to open or close it.

- Please do not try to replace or modify the LED Light.

ProgramS	OPTIONS								
	Drying Level	Delay Start	Buzzer Cancel	Child Lock	Delicate	Time Drying	Level Adjust	Anti-wrinkle	Temperature Level
Normal	✓	✓	✓	✓	✓	X	✓	✓	✓
Outdoor	✓	✓	✓	✓	✓	X	✓	✓	✓
Towels	✓	✓	✓	✓	✓	X	✓	✓	✓
Mix	✓	✓	✓	✓	✓	X	✓	✓	✓
Warm Refresh	X	✓	✓	✓	X	X	X	✓	X
Air Fluff	X	✓	✓	✓	X	X	X	✓	X
Time Drying	X	✓	✓	✓	X	✓	X	✓	✓
Sanitize	✓	✓	✓	✓	X	X	✓	✓	X
Baby Care	✓	✓	✓	✓	✓	X	✓	✓	✓
Delicates	✓	✓	✓	✓	✓	X	X	✓	X
Perm Press	✓	✓	✓	✓	✓	X	✓	✓	✓
Bedding	X	✓	✓	✓	✓	X	X	✓	X
Sports Wear	X	✓	✓	✓	✓	X	✓	✓	✓
Express 29'	✓	✓	✓	✓	X	X	X	✓	X
Shirts 12'	✓	✓	✓	✓	X	X	X	✓	X
X	Not selectable								
✓	Selectable								

5. CLEANING AND CARE

IMPORTANT: Do not use industrial chemicals to clean your dryer. Do not use a dryer that has been cleaned with industrial chemicals.

5.1. Cleaning the Lint Filter

IMPORTANT: DO NOT FORGET TO CLEAN THE LINT FILTER AFTER EACH USE.

To clean the lint filter:

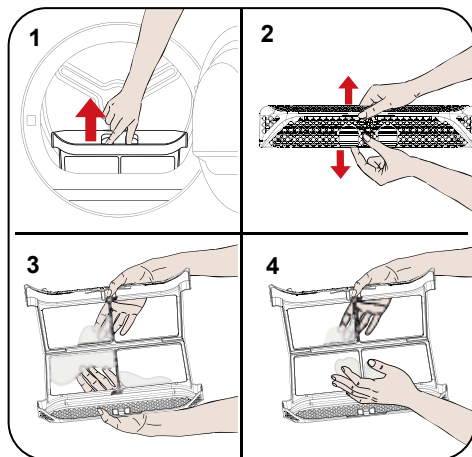

1. Open the loading door.
2. Pull up the lint filter to remove it.
3. Use your hands or a soft cloth to clean the lint.
4. Close and refit the lint filter.

After the dryer has been used for a certain period of time, if you encounter a layer that will cause obstruction on the filter surface, wash the filter with warm water to clean the layer. Dry the filter thoroughly before reinstalling it again.

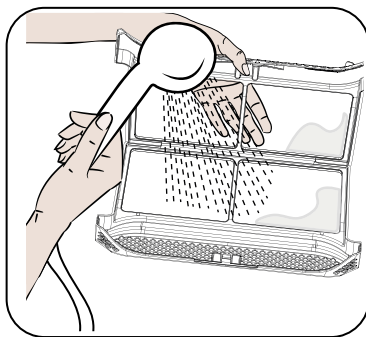

5.2. Emptying the Water Tank

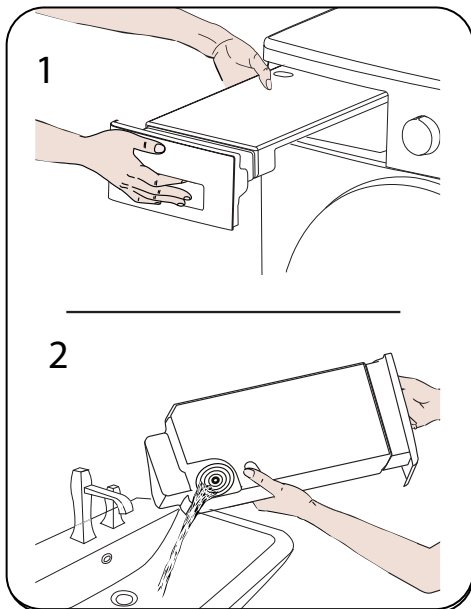

1. Pull the drawer cover and carefully take out the tank.
2. Empty the water in the tank.
3. If there is lint accumulated on the discharge cap in the tank, clean it with water.
4. Refit the water tank.

IMPORTANT: Never remove the water tank when the program is running. The water condensed in the water tank is not suitable for human consumption.

IMPORTANT: DO NOT FORGET TO EMPTY THE WATER TANK AFTER EACH USE.

5.3. Cleaning the Condenser

IMPORTANT: Clean the condenser when you see the warning “Condenser Cleaning”.

IMPORTANT: EVEN IF THE “CONDENSER CLEANING WARNING LED” IS NOT ON: CLEAN THE CONDENSER AFTER EVERY 30 DRYING PROCESSES OR ONCE A MONTH.

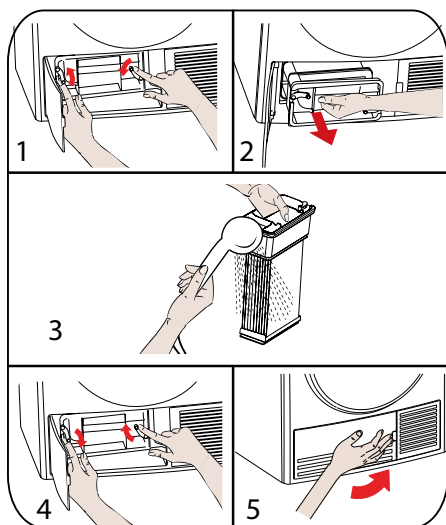

If the drying process is completed, open the loading door and wait for it to cool down.

1. Open the plinth and release the 2 cover locks of the condenser.
2. Hold the condenser by the plastic part and pull it out.
3. Clean it with a showerhead and wait for the water to drain off.
4. Fully insert the condenser into its seat and lock the 2 locks.
5. Close the plinth cover.

5.4. Cleaning the Humidity Sensor

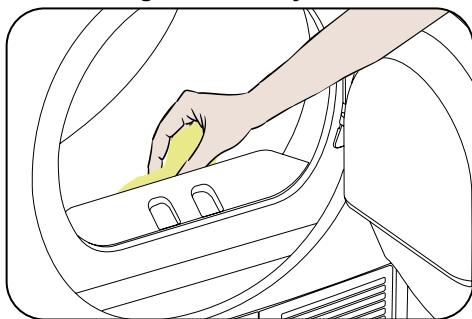

Inside the machine, there are humidity sensors that detect whether the laundry is dry or not.

To clean the sensors:

1. Open the loading door of the machine.
2. If the machine is still hot due to the drying process, wait for it to cool down.
3. Using a soft cloth soaked in vinegar, wipe the metal surfaces of the sensor and dry them.

IMPORTANT: CLEAN THE METAL SURFACES OF THE SENSOR 4 TIMES A YEAR.

IMPORTANT: Do not use metal tools to clean the metal surfaces of the sensor.

WARNING: Due to the risk of fire and explosion, do not use solution agents, cleaning agents or similar products when cleaning the sensors.

5.5. Cleaning the Inner Surface of the Loading Door

⚠ IMPORTANT: DO NOT FORGET TO CLEAN THE INNER SURFACE OF THE LOADING DOOR AFTER EACH DRYING PROCESS.

Open the loading door of the dryer and clean all of the inner surfaces and the gasket with a soft, damp cloth.

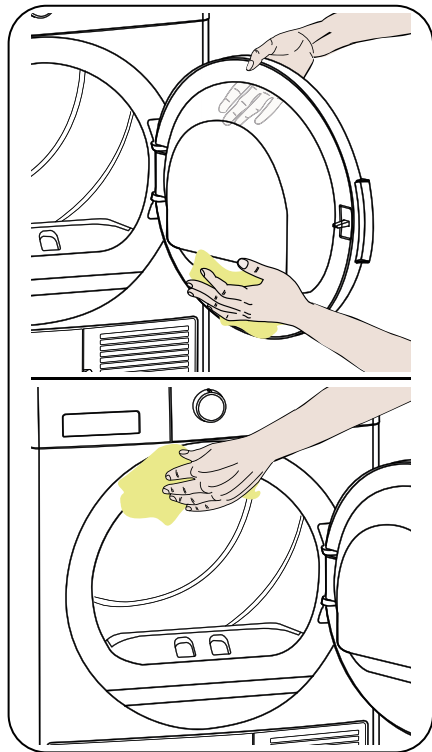

6. TECHNICAL SPECIFICATIONS

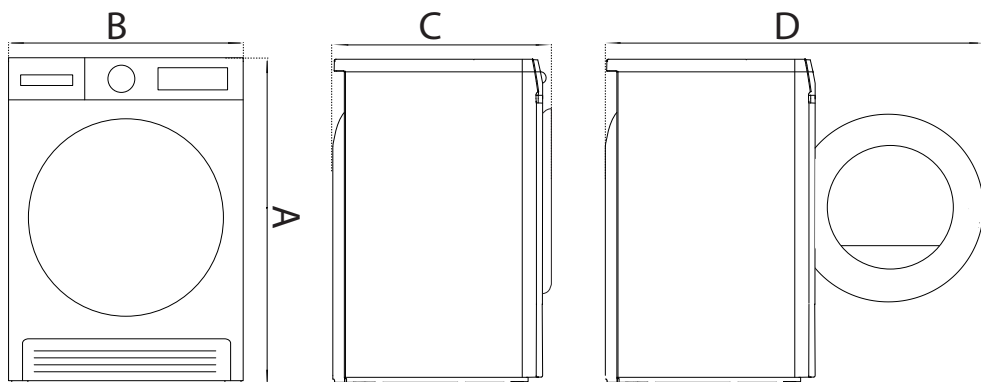

Brand	ELEMENT
Model name	ECD4224EGG
Height (A)	Min: 845 mm / Max: 855 mm
Width (B)	596 mm
Depth (C)	609 mm
Door open dept (D)	1090 mm
Capacity (max.)	9 kg
Net weight (with plastic door)	36,5 kg
Net weight (with glass door)	38,9 kg
Voltage	208-240 V
Power	2700 W

*Min. height: Height with the adjustable feet not used. Max. height: Height with the adjustable feet extended to the maximum.

**Dry laundry weight before washing.

***Aesthetic-based measurements may differ.

IMPORTANT: To improve the quality of the dryer, technical specifications are subject to change without prior notice.

IMPORTANT: The values declared have been obtained in a laboratory environment according to the relevant standards. These values may change depending on the environmental conditions and use of the dryer.

7. TROUBLESHOOTING

Your dryer is fitted with systems that continuously perform checks during the drying process to take the necessary measures and warn you in case of any malfunction.

⚠ WARNING: If the problem persists even if you have applied the steps in this section, please contact the your dealer or an Authorised Service Provider. Never try to repair a nonfunctional product.

PROBLEM	REASON	SOLUTION
The drying process takes a long time.	The surface of the lint filter might be clogged.	Wash the filter with lukewarm water.
	The condenser might be clogged.	Clean the condenser.
	The ventilation grills in front of the machine might be closed.	Open the doors/windows to prevent the room temperature from rising too much.
	There might be a layer of limescale on the humidity sensor.	Clean the humidity sensor.
	The dryer might be overloaded with laundry.	Do not overload the dryer.
	The laundry might be insufficiently spun.	Select a higher spin speed on your washing machine.
Laundry comes out damp at the end of the drying process.	 The laundry that comes out hot at the end of the drying process generally feels more humid.	
	The program used might not be suitable for the type of laundry.	Check the care labels on the laundry items, select a suitable program for the type of laundry and additionally, use the time programs.
	The surface of the lint filter might be clogged.	Wash the filter with lukewarm water.
	The condenser might be clogged.	Clean the condenser.
	The dryer might be overloaded with laundry.	Do not overload the dryer.
	The laundry might be insufficiently spun.	Select a higher spin speed on your washing machine.
The dryer cannot be opened or the program cannot be started. The dryer does not get activated when adjusted.	The dryer might not be plugged in.	Make sure that the plug is fitted in the socket.
	The loading door might be open.	Make sure that the loading door is properly closed.
	You might not have set a program or pressed the Start/Pause key.	Make sure that the program has been set and the dryer is not in the Standby (Pause) mode.
	Child lock might be active.	Deactivate the child lock.
The program has been interrupted for no reason.	The loading door might not be closed properly.	Make sure that the loading door is properly closed.
	There might have been a power failure.	Press the Start/Pause key to start the program.
	The water tank might be full.	Empty the water tank.

PROBLEM	REASON	SOLUTION
Clothes have shrunk, felted or deteriorated.	The program used might not be suitable for the type of laundry.	Check the care labels on the laundry items, select a suitable program for the type of laundry.
Water leaking from the loading door.	There might be lint accumulated on the inner surfaces of the loading door and on the surfaces of the gasket of the loading door.	Clean the inner surfaces of the loading door and the surfaces of the gasket of the loading door.
The loading door opens on its own.	The loading door might not be closed properly.	Push the loading door until you hear the closing sound.
The water tank warning symbol is on/flashing.	The water tank might be full.	Empty the water tank.
	The water discharge hose might be bent.	If the product is connected directly to the water outlet, check the water discharge hose.
The condenser cleaning warning symbol is on.	The condenser might be unclean.	Clean the condenser.
The filter cleaning warning symbol is on.	The lint filter might be unclean.	Clean the filter.
	The filter seat might be clogged by lint.	Clean the filter seat.
	There might be a layer that causes obstruction on the surface of the lint filter.	Wash the filter with lukewarm water.
The program can not be started and the filter warning led is blinking	The filter seat might be clogged by lint.	Clean the filter seat.
	There might be a layer that causes obstruction on the surface of the lint filter.	Wash the filter with lukewarm water.
	The condenser may not be placed.	Replace the condenser.
The program can not be started and both condenser and filter warning leds are blinking	The condenser and filter may not be placed.	Replace the filter and condenser.
	The filter and condenser warning leds are blinking even though the filter and condenser are placed.	Call technical service.

8. AUTOMATIC FAULT WARNINGS AND WHAT TO DO

Your tumble dryer is equipped with a built-in fault detection system, indicated by a combination of flashing operation lights. The most common failure codes are shown below.

ERROR CODE	SOLUTION
E00	Contact the nearest authorised service agent.
E03 / 	Empty the water tank, if problem does not solved, contact the nearest authorised service agent.
E04	Contact the nearest authorised service agent.
E05	Contact the nearest authorised service agent.
E06	Contact the nearest authorised service agent.
E08	There may be voltage fluctuation in mains. Wait until voltage is appropriate for working range.

9. ENVIRONMENTAL PROTECTION AND PACKAGING INFORMATION

9.1. Packaging Information

The packaging of this product is made of recyclable materials. Do not dispose of the packaging, waste together with household or other waste. Instead, take it to a packaging collection point defined by your local authority.

10. Energy Efficiency

- You should operate the dryer to full capacity, but make sure that it is not overloaded.
- When the laundry is being washed, the spin speed should be at the highest level possible. This will shorten the drying time and reduce energy consumption.
- Make sure that the same kinds of laundry are dried together.
- Please follow the recommendations in the user manual for program selection.
- For air circulation, leave an appropriate clearance on the front and back sides of the Dryer. Do not cover the grills on the front side of the machine.
- Unless necessary, do not open the door of the machine when drying. If you have to open it, do not keep it open for a long time.
- Do not add new (wet) laundry during the drying process.
- Hairs and lint that detach from the laundry and merge in the air are collected by the "Lint Filters". Please make sure that the filters are cleaned before and after each use.
- For models with a condenser, make sure that the condenser is cleaned at least once a month or after each 30 uses.
- During the drying process, the environment where the dryer is installed must be well ventilated.

Element Appliance Limited Warranty

(the “Products” or “Product” when referencing a singular product herein)

This Product (including any accessories included in the original packaging) as supplied and distributed in new condition, is warranted by Element Appliance Company, LLC (“Element”) to the original customer who purchases the Product from an authorized Element retailer (the “Original Customer” or “you”) against defects in material and workmanship under proper use, maintenance, and care according to the owner’s manual, warnings, and instructions accompanying the Product (“Warranty”) as follows:

* **PLEASE NOTE** – Proof of purchase evidencing the date of purchase by the Original Purchaser from an authorized Element retailer (“Valid Proof of Purchase”) is **required** for all Warranty service. The express Warranty set forth herein is subject to all terms and conditions set forth below.

1.WARRANTY SERVICE:

A.ONE-YEAR WARRANTY: Except as provided in subpart 1.B below, for a period of **one (1)** year from the date of purchase by the Original Customer (the “Warranty Period”), if the parts or components covered by this Warranty are determined by Element or Element’s authorized service provider to be defective in material or workmanship, Element will, at its sole and absolute discretion and option: (i) repair the defective part or component at no charge to the Original Customer, (ii) replace the defective Product with a new Product of similar or better quality, at no charge to the Original Customer, or (iii) refund the documented purchase price paid by the Original Customer (excluding tax) to the Original Customer upon return of the defective Product as directed by Element. After the Warranty Period expires, the Original Customer must pay for all parts, components, shipping and handling, labor, and replacement costs associated with the Product or any part or component thereof, regardless of any defects in the Product or any part or component thereof

B.LIMITED EXTENDED WARRANTY THROUGH PRODUCT REGISTRATION:

If and only if the Original Customer registers the Product at www.elementelectronics.com within **ninety (90)** days of the date of purchase by the Original Customer, then the Warranty Period discussed in subpart 1.A. above shall be extended an additional one (1) year to a new Warranty Period equaling **two (2) years** from the date of purchase by the Original Customer. If the Product is not registered as provided for in this subpart 1.B, then the standard one-year Warranty Period set forth in subpart 1.A shall apply.

C.TIMING AND PROCEDURE: Before Warranty service can commence, the Original Customer must contact either (i) the retailer from whom the Original Customer purchased the Product, or (ii) Element directly, in either case for problem determination and service procedures. Valid Proof of Purchase evidencing that the Product is within the Warranty Period **MUST** be presented by Original Customer in order to obtain the requested Warranty service. Please have your model and serial number available, along with your date of purchase of the Product. To remain eligible for Warranty service, Original Customer may not return the Product or any part or component thereof to the retailer or Element without Element’s prior written consent.

2.EXCLUSIONS AND LIMITATIONS TO WARRANTY SERVICE

The Warranty covers manufacturing defects in materials and workmanship of the Product encountered in the normal, non-commercial use of the Product, and does not cover (a) damages or malfunctions resulting from improper or unreasonable use or maintenance, abuse, negligence, failure to follow instructions contained in any written materials that accompany the Product, deterioration by reason of excess moisture, corrosive atmosphere, lightning, power surges, connections to improper voltage supply, unauthorized alteration, or other external causes such as extremes in temperature or humidity, modifications, scratches or discoloration; (b) any damage caused by using non-authorized parts or service facilities for repair of Products (however, for avoidance of doubt, using non-authorized parts or service facilities will not, in and of itself, void the Warranty); (c) transportation, shipping, delivery, pickup, insurance, installation, or set-up costs; (d) ordinary wear and tear, cosmetic damage, or damage due to acts of nature, including but not limited to, water, floods, wind, storm, tornado, earthquake, or fire, or due to damage caused by extraordinary impact events, such as dropping, crushing, demolition or other extraordinary damage; (e) commercial use of the Product, or use of the Product for anything other than single-family household or residential use; or (f) modification of the Product or any part of the Product.

This Warranty is made to the Original Customer only and does not cover Products sold AS IS or WITH ALL FAULTS. The Warranty is invalid if the factory-applied serial number has been altered or removed from the Product. This Warranty is valid only in the United States, and only applies to Product if it was purchased and serviced in the United States. The addition of equipment or features to the Product that are not manufactured or recommended by Element could affect the intended function of the Product, and therefore may void the Warranty. Furthermore, the exposure of the Product to chemicals, heat, cold, humidity, or other elements can affect the Product components, and therefore, the Warranty does not cover discoloration, fading, cosmetic changes, rust, or any damages or failure related to any such items. The Warranty is contingent upon the proper use, maintenance, and care of the Product. The Warranty may be void if the Product has been used in a manner contradictory to, or in violation of, the terms of the user's manual, warnings, or instructions accompanying the Product.

THIS WARRANTY IS MADE IN LIEU OF AND SUPERSEDES ALL OTHER WARRANTIES OR CONDITIONS OF MERCHANTABILITY OR FITNESS FOR A PARTICULAR PURPOSE OR GENERAL USE, WHETHER EXPRESS, IMPLIED, COLLATERAL, STATUTORY, OR PROVIDED BY COMMON LAW, THE UNIFORM COMMERCIAL CODE, OR OTHERWISE. ELEMENT FURTHER DISCLAIMS ALL WARRANTIES AFTER THE END OF THE WARRANTY TERM DEFINED ABOVE. NO OTHER EXPRESS WARRANTY OR GUARANTY GIVEN BY ANY OTHER PERSON, FIRM, OR ENTITY WITH RESPECT TO THE PRODUCT SHALL BE BINDING ON ELEMENT. REPAIR, REPLACEMENT, OR REFUND OF THE ORIGINAL PURCHASE PRICE, AT ELEMENT'S SOLE DISCRETION, ARE THE EXCLUSIVE REMEDIES OF THE CUSTOMER.

ELEMENT SHALL NOT BE LIABLE FOR ANY INCIDENTAL OR CONSEQUENTIAL DAMAGES CAUSED BY THE USE, MISUSE, OR INABILITY TO USE THE PRODUCT. THESE INCLUDE, BUT ARE NOT LIMITED TO, ANY DAMAGES IN THE FORM OF LOST PROFITS, LOSS OF USE, LEGAL FEES, ECONOMIC LOSS, PERSONAL INJURIES, OR ANY OTHER DAMAGES CAUSED BY CIRCUMSTANCES BEYOND THE CONTROL OF ELEMENT. NOTWITHSTANDING THE FOREGOING, ELEMENT'S AGGREGATE LIABILITY TO ANY CUSTOMER SHALL NOT EXCEED THE ORIGINAL PURCHASE

PRICE OF THE PRODUCT. THIS WARRANTY SHALL NOT EXTEND TO ANYONE OTHER THAN THE ORIGINAL CUSTOMER WHO PURCHASED THE PRODUCT, AND IS NOT TRANSFERRABLE. NO PERSON IS AUTHORIZED TO ALTER, EXTEND, OR WAIVE THIS WARRANTY OR ANY OF ITS TERMS OR CONDITIONS.

Some states do not allow the exclusion or limitation of incidental or consequential damages, or allow limitations on warranties, so the above limitations or exclusions may not apply to you. This Warranty gives you specific rights, and you may have other rights, which vary from state to state. The exclusions and limitations to the Warranty apply to the maximum extent permitted by law and unless restricted or prohibited by law. Where any term of this Warranty is prohibited by applicable law, it shall be null and void, but the remainder of this Warranty shall remain in effect.

PLEASE DIRECT ALL CORRESPONDENCE TO:

Element Appliance Company, LLC
customerservice@elementelectronics.com
(888) 842-3577
<https://elementelectronics.com>

Element, the Element Logo, and Bring it home are trademarks of Element Brand Holding, LLC. All other trademarks are the property of their respective owner, who has not sponsored, endorsed, or approved this product. ©2025 Element Appliance Company, LLC. All rights reserved.

Distributed by Element Appliance Company, LLC
Augusta, GA 30909

For service, support and warranty information:
Call 888.842.3577, email us at customerservice@elementelectronics.com or
visit www.elementelectronics.com

Printed in Turkey



52572734-250808-00