



YARD FORCE®

FOR LIFE ON THE GO

LW CPC1

Q0QS-SP02-220

GB

20V CORDLESS PATIO CLAENER

Original Instructions

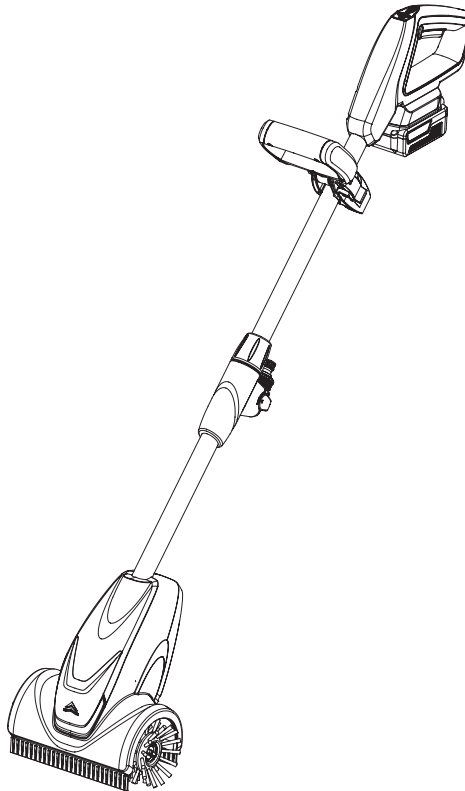

**READ & UNDERSTAND
INSTRUCTION MANUAL**

Save all warnings and instructions for future reference.

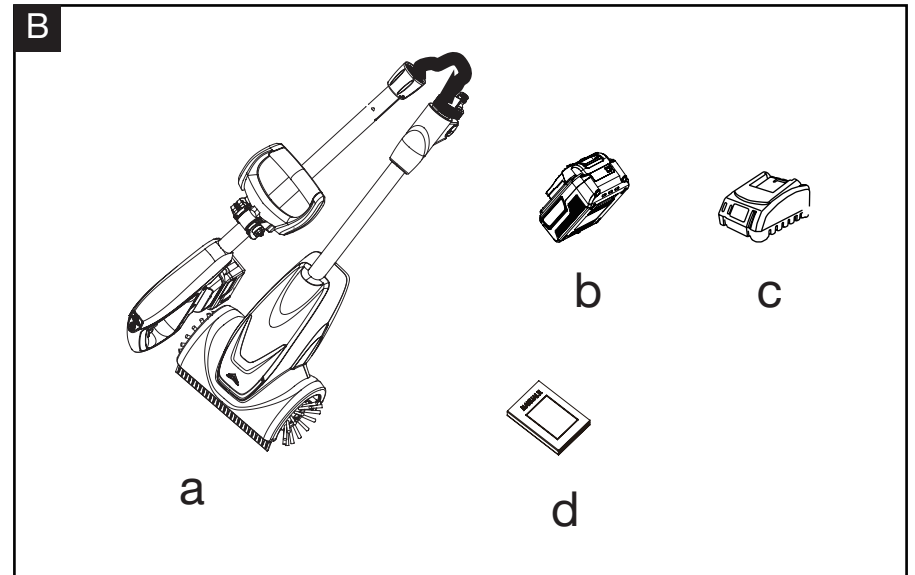
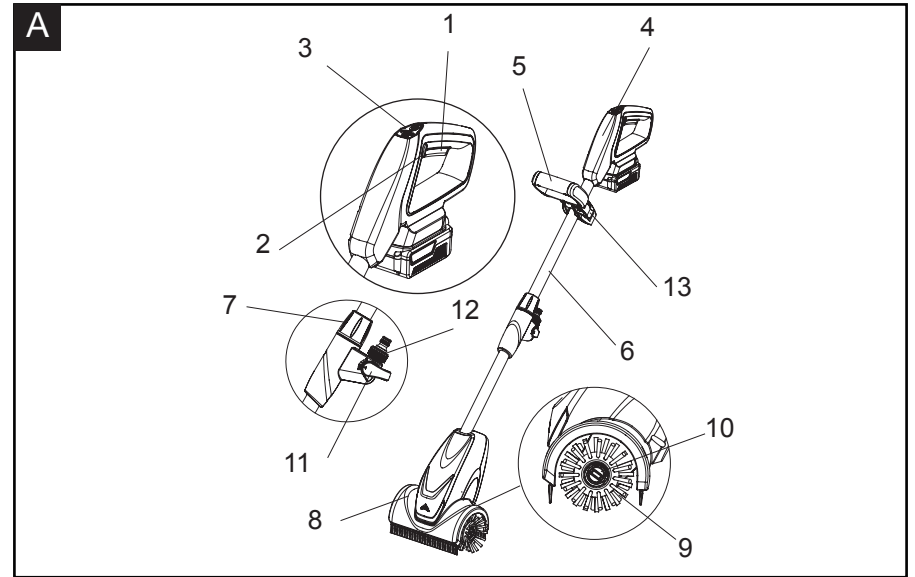

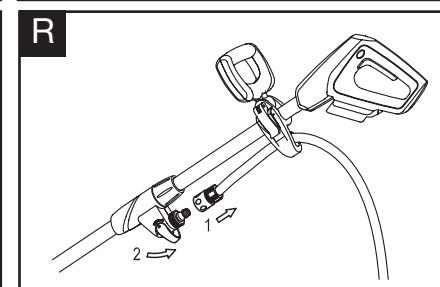
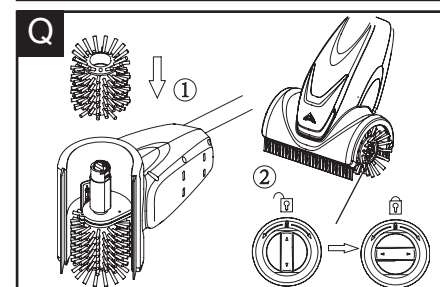
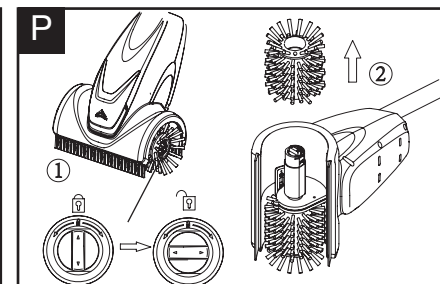
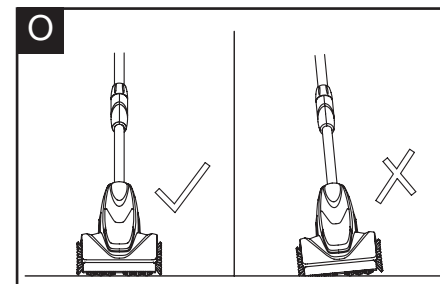
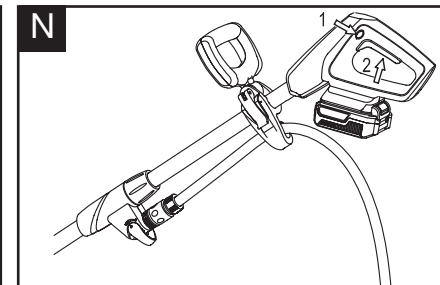
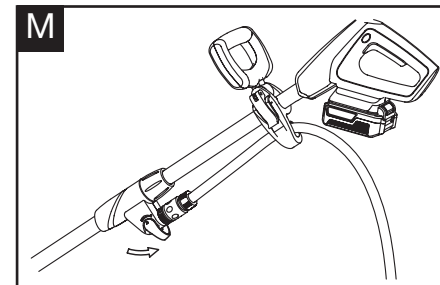
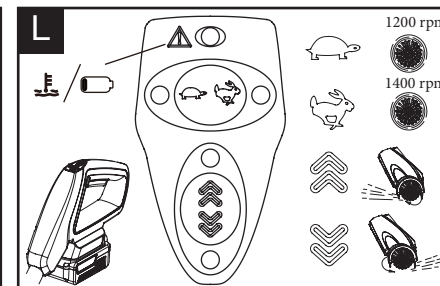
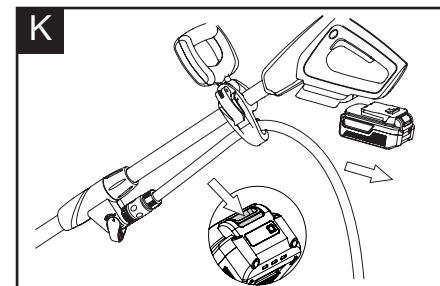
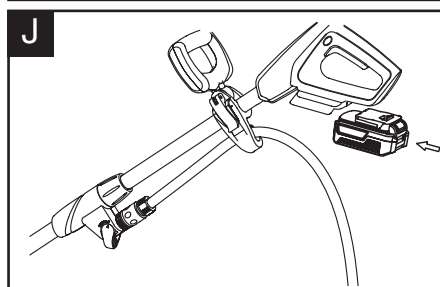
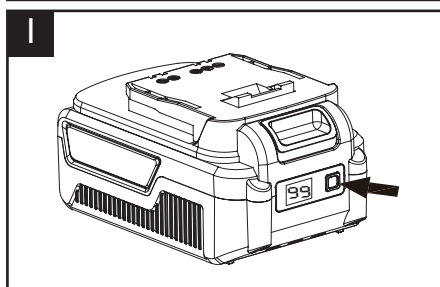
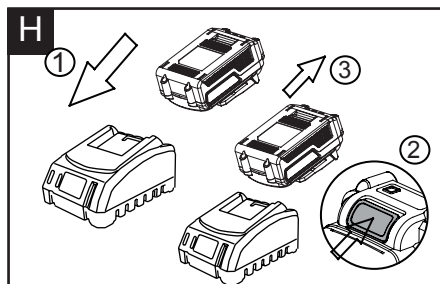
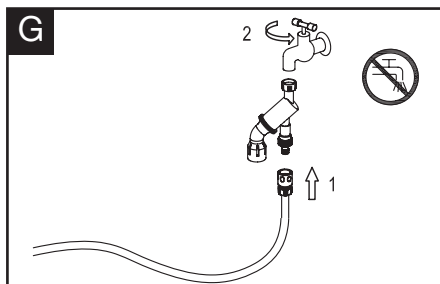
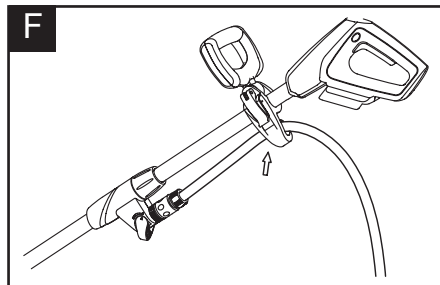
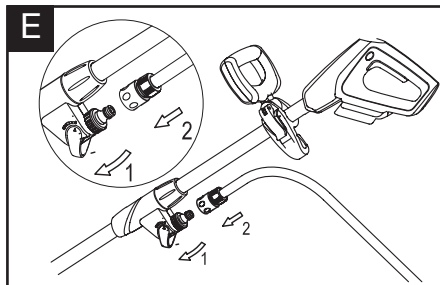
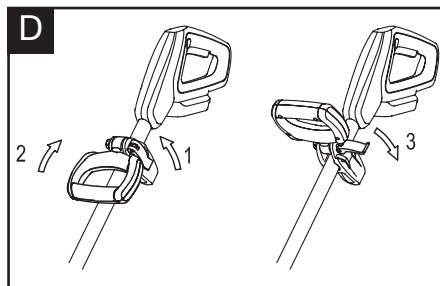
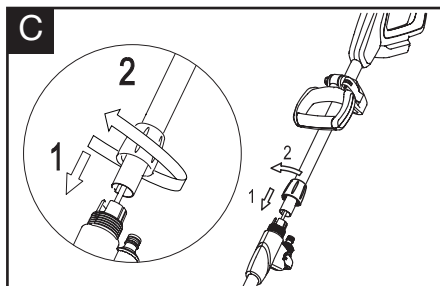

CONTENT

Intended use	07
General safety warnings	07
Product safety warnings	13
Symbols	15
Technical data	20
Description of product	21
Operation	22
Maintenance and storage	25
Troubleshooting	26
Declaration of conformity	27

INTENDED USE

Use the device only on pre-cleaned surfaces and observe the safety instructions. The device is intended for the removal of soiling from outdoor surfaces, such as e.g. terraces. The device is suitable for wooden, stone or composite material (WPC) surfaces, according to the brushes used.

Any type of improper use is prohibited. The operating personnel are liable for damage resulting from incorrect use.

Do not use the device for cleaning planted areas.

GENERAL SAFETY WARNINGS

WARNING

Read all safety warnings, instructions, illustrations and specifications provided with this power tool. Failure to follow all instructions listed below may result in electric shock, fire and/or serious injury.

Save all warnings and instructions for future reference. The term “power tool” used in the warnings refers to your mains-operated (corded) power tool or battery-operated (cordless) power tool.

Work place safety

1. Keep work area clean and well lit. Cluttered or dark areas invite accidents.
2. Do not operate power tools in explosive atmospheres, such as in the presence of flammable liquids, gases or dust. Power tools create sparks which may ignite the dust or fumes.
3. Keep children and bystanders away while operating a power tool. Distractions can cause you to lose control.

GENERAL SAFETY WARNINGS

Electrical safety

1. Power tool plugs must match the outlet. Never modify the plug in any way. Do not use any adapter plugs with earthed (grounded) power tools. Unmodified plugs and matching outlets will reduce risk of electric shock.
2. Avoid body contact with earthed or grounded surfaces, such as pipes, radiators, ranges and refrigerators. There is an increased risk of electric shock if your body is earthed or grounded.
3. Do not expose power tools to rain or wet conditions. Water entering a power tool will increase the risk of electric shock.
4. Do not abuse the cord. Never use the cord for carrying, pulling or unplugging the power tool. Keep cord away from heat, oil, sharp edges or moving parts. Damaged or entangled cords increase the risk of electric shock.
5. When operating a power tool outdoors, use an extension cord suitable for outdoor use. Use of a cord suitable for outdoor use reduces the risk of electric shock.
6. If operating a power tool in a damp location is unavoidable, use a residual current device (RCD) protected supply. Use of an RCD reduces the risk of electric shock

NOTE: The term "residual current device (RCO)" can be replaced by the term "ground fault circuit interrupter (GFCI)" - "earth leakage circuit breaker (ELCS)".

GENERAL SAFETY WARNINGS

Personal safety

1. Stay alert, watch what you are doing and use common sense when operating a power tool. Do not use a power tool while you are tired or under the influence of drugs, alcohol or medication. A moment of inattention while operating power tools may result in serious personal injury.
2. Use personal protective equipment. Always wear eye protection. Protective equipment such as a dust mask, non-skid safety shoes, hard hat or hearing protection used for appropriate conditions will reduce personal injuries.
3. Prevent unintentional starting. Ensure the switch is in the off-position before connecting to power source and/or battery pack, picking up or carrying the tool. Carrying power tools with your finger on the switch or energising power tools that have the switch on invites accidents.
4. Remove any adjusting key or wrench before turning the power tool on. A wrench or a key left attached to a rotating part of the power tool may result in personal injury.
5. Do not overreach. Keep proper footing and balance at all times. This enables better control of the power tool in unexpected situations.
6. Dress properly. Do not wear loose clothing or jewellery. Keep your hair and clothing away from moving parts. Loose clothes, jewellery or long hair can be caught in moving parts.
7. If devices are provided for the connection of dust

GENERAL SAFETY WARNINGS

extraction and collection facilities, ensure these are connected and properly used. Use Of dust collection can reduce dust-related hazards.

8. Do not let familiarity gained from frequent use of tools allow you to become complacent and ignore tool safety principles. A careless action can cause severe injury within a fraction of a second.

Power tool use and care

1. Do not force the power tool. Use the correct power tool for your application. The correct power tool will do the job better and safer at the rate for which it was designed.
2. Do not use the power tool if the switch does not turn it on and off. Any power tool that cannot be controlled with the switch is dangerous and must be repaired.
3. Disconnect the plug from the power source and/ or remove the battery pack, if detachable, from the power tool before making any adjustments, changing accessories, or storing power tools. Such preventive safety measures reduce the risk of starting the power tool accidentally.
4. Store idle power tools out of the reach of children and do not allow persons unfamiliar with the power tool or these instructions to operate the power tool. Power tools are dangerous in the hands of untrained users.
5. Maintain power tools and accessories. Check for misalignment or binding of moving parts, breakage Of parts and any other condition that may affect the power tool's operation. If damaged, have the power

GENERAL SAFETY WARNINGS

tool repaired before use. Many accidents are caused by poorly maintained power tools.

6. Keep cutting tools sharp and clean. properly maintained cutting tools with sharp cutting edges are less likely to bind and are easier to control.
7. Use the power tool, accessories and tool bits etc. in accordance with these instructions, taking into account the working conditions and the work to be performed. Use of the power tool for operations different from those intended could result in a hazardous situation.
8. Keep handles and grasping surfaces dry, clean and free from oil and grease. Slippery handles and grasping surfaces do not allow for safe handling and control of the tool in unexpected situations.

Battery tool use and care

1. Recharge only with the charger specified by the manufacturer. A charger that is suitable for one type of battery pack may create a risk of fire when used with another battery pack.
2. Use power tools only with specifically designated battery packs. Use of any other battery packs may create a risk of injury and fire.
3. When battery pack is not in use, keep it away from other metal objects, like paper clips, coins, keys, nails, screws or other small metal objects, that can make a connection from one terminal to another. Shorting the battery terminals together may cause

GENERAL SAFETY WARNINGS

burns or a fire.

4. Under abusive conditions, liquid may be ejected from the battery; avoid contact. If contact accidentally occurs, flush with water. If liquid contacts eyes, additionally seek medical help. Liquid ejected from the battery may cause irritation or burns.
5. Do not use a battery pack or tool that is damaged or modified. Damaged or modified batteries may exhibit unpredictable behaviour resulting in fire, explosion or risk of injury.
6. Do not expose a battery pack or tool to fire or excessive temperature. Exposure to fire or temperature above 130 °C may cause explosion.
7. Follow all charging instructions and do not charge the battery pack or tool outside the temperature range specified in the instructions. Charging improperly or at temperatures outside the specified range may damage the battery and increase the risk of fire.

service

1. Have your power tool serviced by a qualified repair person using only identical replacement parts. This will ensure that the safety of the power tool is maintained.
2. Never service damaged battery packs. Service of battery packs should only be performed by the manufacturer or authorized service providers.

Safety instructions

1. Please observe the requirements of EN 1717 when

PRODUCT SAFETY WARNINGS

connecting this product to the drinking water network and contact your sanitation specialists if you have any queries.

2. Operate the device only with untreated, clean fresh water. The device must not under any circumstances be operated with explosive, corrosive or inflammable substances.
3. The water temperature must not exceed 35°C.
4. Never fully immerse the device in liquids.
5. Only operate the device outdoors.
6. Regularly check the device for damage. Do not operate the device if you discover visible damage.
7. Do not use the device on surfaces where water is already present.
8. Ensure that the surface to be cleaned is free of sand, stones or loose elements before starting work. These can be flung away during cleaning or damage the surface and the device.
9. Do not pull on the connected hose.
10. Only switch the device on when the brushes are on the floor.
11. Do not lift the device off the floor when switched on.
12. All live parts in the work area must be protected against spray water.
13. Protect the device from frost and excessive heat (permitted ambient temperature range of 5 °C to 40 °C).
14. Do not operate the device in the vicinity of devices that are connected to electrical power.

Maintenance and storage

1. Keep all nuts, bolts and screws tight to be sure the product is in a safe working condition.
2. Be careful when adjusting the product to prevent trapping fingers between moving parts or other fixed parts of the product.
3. Always allow the product to cool down before storing.
4. Replace worn or damaged parts for safety. Use only genuine replacement parts and accessories.
5. DO NOT attempt to open the charger and battery pack. There are no customer serviceable parts inside. Return to any authorised service centre.
6. Store the appliance with battery pack fully charged at room temperature (around 20 °C).
7. Every deep discharge cycle decreases the capacity of battery pack. To prolong battery life, it is recommended that you charge the battery every six months within extended periods of time when the product is not in use.

Safety symbols

The purpose of safety symbols is to attract your attention to possible dangers. The safety symbols and the explanations with them require your careful attention and full understanding. The symbol warnings do not, by themselves, eliminate any danger. The instructions and warnings they give are no substitutes for proper accident prevention measures.

WARNING: Be sure to read and understand all safety instructions in this operator's manual, including all safety alert symbols such as "**DANGER**," "**WARNING**," and "**CAUTION**" before using this tool. Failure to follow all instructions listed below may result in electric shock, fire and/or serious personal injury.



SAFETY ALERT SYMBOL: Indicates **DANGER**, **WARNING**, or **CAUTION**. May be used in conjunction with other symbols or pictographs.

Symbol meaning

This page depicts and describes safety symbols that may appear on this product. Read, understand and follow all instructions on the machine before attempting to assemble and operate.

SYMBOLS



This symbol, before a safety comment, indicates a precaution, a warning or a danger. Ignoring this warning can lead to an accident for yourself or for others. To limit the risk of injury, fire, or electrocution always apply the recommendations indicated.



To reduce the risk of injury, user must read the instruction manual carefully.



Wear protective goggles.



Wear suitable protective gloves.



Wear ear protection



Wear a dust mask.



Wear foot protection



Protect against rain and wet.
Do not expose and operate the tool in rain.

SYMBOLS



Ensure that other people and pets remain at least 15m away from the device when it is in use.



Risk of damage. Do not clean the device with a hose or high-pressure water jet!



WEEE symbol. Waste electrical products should not be disposed of with household waste. Please recycle where facilities exist. Check with your Local Authority or local store for recycling advice.



The product complies with the applicable European directives and an evaluation method of conformity for these directives was done.



Conforms to relevant UK regulatory requirements

SYMBOLS

Warning symbols on the battery pack



To reduce the risk of injury, user must read the instruction manual carefully.



Do not throw into water.



Do not throw to fire.



Do not subject the battery to strong sunlight over long periods of time. Do not leave on a heater (max.50°C).



Li-Ion

Batteries contain Li-ion. Do not dispose of waste batteries in domestic waste. Contact local authority to find out how to dispose of batteries.



WEEE symbol. Waste electrical products should not be disposed of with household waste. Please recycle where facilities exist. Check with your Local Authority or local store for recycling advice.

SYMBOLS

Warning symbols on the charger



To reduce the risk of injury, user must read the instruction manual carefully.



The charger is for indoor use only.



Double insulation



WEEE symbol. Waste electrical products should not be disposed of with household waste. Please recycle where facilities exist. Check with your Local Authority or local store for recycling advice.



The product complies with the applicable European directives and an evaluation method of conformity for these directives was done.

T3.15A



Protective 3.15 A limited

TECHNICAL DATA

Model		LW CPC1
Mains voltage		20 V \equiv
No load speed		1200/ 1400 min ⁻¹
Working width		200 mm
Brush diameter		100 mm
Inlet pressure		Max. 1 MPa
Weight:		4.9 kg
Battery pack model		B0P-SP06-20ZL
Capacity		20 V \equiv , 4 Ah
Charger model		VDE: B0Q-SP06-20ZA BS: B0Q-SP06-20ZB
Input		220–240 V~, 50/60 Hz 65 W
Output:		20 V \equiv , 2.4 A
Protection class		II

DESCRIPTION OF PRODUCT

Parts description (Fig. A)

1. Power ON/OFF trigger
2. Safety lock off button
3. Control panel
4. Main handle
5. Auxiliary handle
6. Aluminum tube
7. Locking collar
8. Working head
9. Rotating brushes
10. Brush locking knob
11. Water volume regulation valve
12. Inlet connector
13. Hose support

Delivery contents (Fig. B)

Carefully unpack the appliance and check that it is complete. Dispose of the packaging material correctly.

- a. Patio cleaner
- b. Battery pack
- c. Charger
- d. Instruction manual



WARNING: If any parts are damaged or missing, do not operate this tool until these parts are replaced. Failure to heed this warning could result in serious personal injury.



NOTE: Always recycle the packaging in accordance with local recycling guidelines.

OPERATION

Installation

Assembly of the handle and housing

1. Align and insert the upper tube with the lower housing tube as shown in **Fig C** (make sure the connecting cable is not twisted)
2. Rotate the Locking collar clockwise until the lock collar is fully secured in place.
3. Check the upper and lower are fully locked & secured in place.

Adjust Auxiliary handle (Fig. D)

1. Release the locking lever.
2. Rotate the auxiliary handle and adjust the position of the handle on the tube.
3. Now close the locking lever to fully lock the handle into position.

Initial startup

1. Close the water volume regulation valve. **(Fig. E)**
2. Connect the water hose to the device. The coupling must audibly engage fully.
3. Secure the water hose to the hose hook. **(Fig. F)**
4. Connect the water hose to the water tap and open the water tap. Please observe the maximum water pressure (see "Technical data"). **(Fig. G)**

Charging the battery pack

NOTE: Remove the battery pack from the charger after it has been fully charged.

NOTE: Battery should be fully charged before first use.

NOTE: Make sure the mains voltage is the same as rating label which is located on the charger.

1. Connect the charger to a power supply. Red LED will light up.
2. To insert the battery pack into the charger, align the raised ribs of the battery pack with the grooves of the charger then push it in. **(Fig. H)**
3. The red LED light of the charger will go off and then the green light flashes during normal charging.
4. After charging is complete, the charger light will turn to a solid green light.
5. Once the battery is fully charged, remove the battery pack.

Battery power indicator (Fig. I)

This Li-Ion battery pack is equipped with a power indicator which is used to show the battery pack's remaining charge. Press the power indicator button to check battery charge as picture showed. The indicator will stay lit for approximately 4 seconds.

OPERATION

To obtain the best life from the battery

1. Never allow the battery to completely discharge before recharging. The battery pack should be placed on the charger whenever the battery pack is noticeably running down or the tool no longer performs a task it previously performed.
2. Avoid conducting short charges. Make sure that the battery is fully charged each time by allowing the charger to complete its full charging cycle.
3. Avoid allowing loose items like screws or nails etc. to be stored with battery packs as these or similar items can short battery packs and cause a fire or explosion.
4. Always unplug the charger when not in use and store in a dry and secure place.
5. Avoid charging or storing your battery in temperatures below 5 °C and above 45 °C.
6. After use, allow the battery pack to cool down for approximately 30 minutes before attempting to recharge.

Attaching/Detaching the battery pack

Fully charge before first use.

To Attach

Align the battery ribs with the mounting slots and push the battery pack into place until you hear a "click". **(Fig. J)**

To Detach (Fig. K)

Depress the battery release button and remove the battery pack

Before operating, look around you to ensure a safety working area without other people, animals or any loose objects. And then check for eye protection, proper clothing and balanced footing.

Before starting

1. Select the speed and cleaning direction, default high speed, forward cleaning. **(Fig. L)**
2. Open the water volume regulation valve. **(Fig. M)**

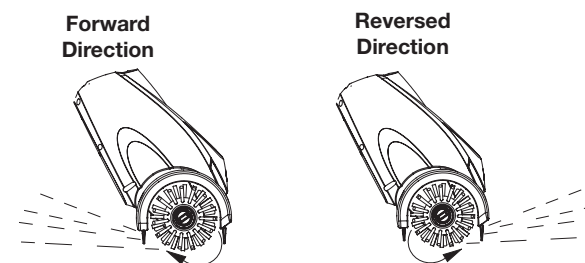

Switching ON/OFF the device (Fig. N)

1. Depress the safety lock off button
2. Depress the Power ON/OFF lever
3. Release the Power ON/OFF lever to stop the device

OPERATION

Overload warning indicator (Fig. L)

This machine equipped with an overload warning indicator, the indicator will flashing when:

- The patio cleaner is overloaded.
- The patio cleaner is overheated.
- battery pack low capacity.

Cleaning wooden surfaces

Test the device on an inconspicuous area before using on sensitive surfaces, e. g. wood. Do not allow the machine to be stationary in one area and keep the product moving to increase the cleaning efficiency

NOTE: Pre-treatments may be removed from pre-treated surfaces. Uneven light-dark effects result from the type of wood or its treatment. It is a desirable result to remove the film on weathered wooden surfaces.

Apply a suitable care agent or preservative after cleaning for optimum results!

Correct handling of the brushes

Use only the brushes suitable for the surface to be cleaned. Observe the following instructions for correct use of the brushes. Position the brushes evenly on the surface to be cleaned. **(FIG. O)** Guide the brushes over the surface with light pressure.

Cleaning and replacing brushes



DANGER

Danger of electric shock Injuries due to touching live parts. Switch off the device. Remove the battery pack.

NOTE

Always replace both brushes at the same time. The brushes must be replaced when the gearbox housing touches the ground while cleaning the surface without exerting pressure on the device.



ATTENTION

Danger of burns
The gearbox can be very hot after use. Allow the device to cool down before replacing the brushes.

1. Rotate the knob 1/4 turn that holds the roller brush. **(FIG. P)**
2. Remove the brush. **(FIG. P)**
3. Re-assemble the clean or new brush. **(FIG. Q)**

MAINTENANCE AND STORAGE

WARNING: Before performing any repair work, always remove the battery pack and wait until the cutting blade has come to a standstill.

CLEANING

1. Clean the unit using a damp cloth with a mild detergent.
2. Do not use any strong detergents on the plastic housing or the handle. They can be damaged by certain aromatic oils, such as pine and lemon, and by solvents such as kerosene. Moisture can also cause a shock hazard. Wipe off any moisture with a soft dry cloth.
3. Use a small brush to clean the air vents on the rear housing.

CLEANING THE WATER FILTER

If the water flow is inadequate then the water filter in the device must be cleaned.

1. Unscrew the hose connector at the water connection.
2. Pull out the water filter. **(FIG. R)**
3. Clean the water filter under running water against the normal flow direction.
4. Fit the water filter.
5. Screw on the hose connector.

NOTE: Ensure that the sealing ring in the plug connector has been inserted correctly.

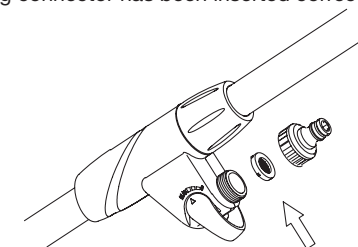

STORING THE UNIT

1. Remove the battery pack from the line trimmer when it is not in use.
2. Clean the tool thoroughly before storing it.
3. Store the unit in a dry, well-ventilated area, locked-up or up high, out of the reach of children. Do not store the unit on or adjacent to fertilizers, petrol, or other chemicals.

TRANSPORT

Use the original packaging to ship whenever possible.

MAINTENANCE AND STORAGE

 **WARNING:** Before performing any repair work, always ensure that the battery pack has been removed.

 **WARNING:** Always wear heavy duty gloves when adjusting or cleaning, especially when handling sharp objects.

Fault/malfunction	Cause	Remedy
Machine does not start	Battery pack not properly attached	Attach properly
	Battery pack discharged	Remove and charge the battery pack
	Battery pack damaged	Contact our service centre
	Other electrical defect to the product	Contact our service centre
	Overload LED activated	Overload -Wait until the Overload resets Overheat - cool down for 10min Battery pack lack of power - charge the battery pack
Poor cleaning performance	Dirty brushes	Clean the brushes
	Worn brushes	Replace the brushes
No water is being sprayed	Water volume regulation valve closed	Open the valve
	Clogged water filter	Clean water filter

DECLARATION OF CONFORMITY

To the provisions of Council Directives

We
SUMEC UK
Unit A&B Escrick Business Park Escrick, York YO19 6FD
United Kingdom

Declare that the product:
Description: 20V Patio cleaner
Model No. LW CPC1/ Q0QS-SP02-220
Function: Floor cleaning

Complies with the essential health and safety requirements of the following directives:

Supply of Machinery (Safety) Regulations 2008
Electrical Equipment (Safety) Regulations 2016
The Restriction of the Use of Certain Hazardous Substances in Electrical and Electronic Equipment Regulations 2012

Standards and technical specification referred to:

EN 62841-1: 2014, COR1:2014, COR2:2015
EN 62841-1: 2015
EN ISO 12100: 2010
EN 62233: 2008
EN 55014-1: 2017+A11:2020
EN 55014-2: 2015

Authorized Signatory
Date: 18.07.2021

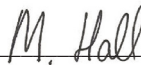
Signature: 
Place: York
Name: Mariana Hall
General Manager

SUMEC UK Co.,Ltd.
Unit A&B Escrick Business Park
Escrick, York YO19 6FD
United Kingdom

**UK
CA**

DECLARATION OF CONFORMITY

To the provisions of Council Directives

We
SUMEC France Sarl
59 bis Rue du Mûrier
37540 Saint Cyr Sur Loire, France

Declare that the product:
Description: 20V Patio cleaner
Model No. LW CPC1/ Q0QS-SP02-220
Function: Floor cleaning

Complies with the essential health and safety requirements of the following directives:

Machinery Directive 2006/42/EC
Electromagnetic Compatibility Directive 2014/30/EU
EC Directive 2011/65/EU and its amendment Directive (EU) 2015/863 (RoHS)

Standards and technical specification referred to:

EN 62841-1: 2015
EN ISO 12100: 2010
EN 62233: 2008
EN 55014-1: 2017+A11:2020
EN 55014-2: 2015

Authorized Signatory
Date: 18.07.2021

Signature: 
Place: Saint Cyr Sur Loire
Name: Rodolphe Dubois
General Manager

SUMEC France Sarl
59 bis Rue du Mûrier
37540 Saint Cyr Sur Loire, France

