

Operator's Manual



NEXTEC

12.0-VOLT LITHIUM-ION CORDLESS LED WORKLIGHT

Model No. 320. 10005

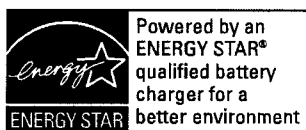
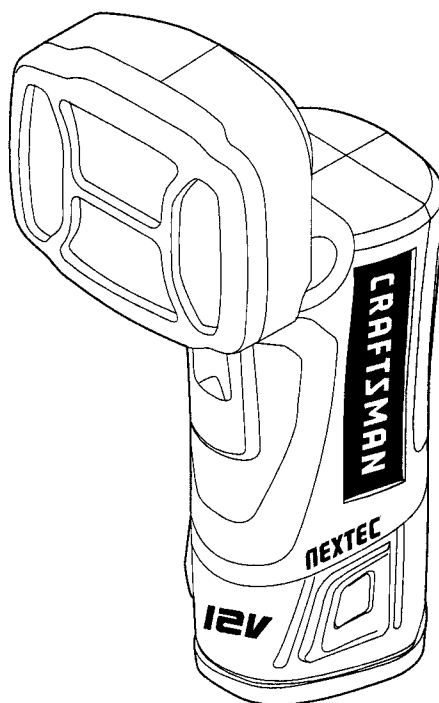

⚠ CAUTION! Read, To reduce the risk of injury, the user must Read and understand the Operator's manual before using this product.

- **Warranty**
- **Safety**
- **Operation**
- **Assembly**
- **Maintenance**

Charge battery before first use

Sears Brands Management Corporation

www.craftsman.com

TABLE OF CONTENTS

Warranty	Page 2
Safety Symbols	Page 3
Safety Instructions	Page 5-12
Description	Page 12-13
Assembly	Page 14
Operation	Page 14-18
Maintenance	Page 19-20
Exploded View and Parts List	Page 20-21
Sears Repair Parts Phone Number	Back Cover

ONE YEAR FULL WARRANTY ON CRAFTSMAN® TOOL

If this Craftsman tool fails to give complete satisfaction within one year from the date of purchase, return it to any Sears store or Parts & Repair Center or other Craftsman outlet in the United States for free repair (or replacement, if repair proves impossible).

This warranty does not include expendable parts such as lamps, batteries, bits, or blades.

This warranty applies for only 90 days from the date of purchase if this product is ever used for commercial or rental purposes.

This warranty gives you specific legal rights, and you may also have other rights which vary from state to state.

Sears, Roebuck and Co., Hoffman Estates IL 60179

INTRODUCTION

SAVE THESE INSTRUCTIONS!

⚠ WARNING: This LED Worklight has many features for making its use more pleasant and enjoyable. Safety, performance, and dependability have been given top priority in the design of this product, making it easy to maintain and operate.

SAFETY SYMBOLS

The purpose of safety symbols is to attract your attention to possible dangers.

The safety symbols and the explanations with them deserve your careful attention and understanding. The symbol warnings do not, by themselves, eliminate any danger. The instructions and warnings they give are no substitutes for proper accident prevention measures.

⚠ WARNING: BE SURE to read and understand all safety instructions in this manual, including all safety alert symbols such as “DANGER,” “WARNING,” and “CAUTION,” before using this tool stand. Failure to following all instructions listed below may result in electric shock, fire, and/or serious personal injury.

SYMBOL SIGNAL MEANING

⚠ DANGER: Indicates an imminently hazardous situation, which, if not avoided, will result in death or serious injury.

⚠ WARNING: Indicates a potentially hazardous situation, which, if not avoided, could result in death or serious injury.

⚠ CAUTION: Indicates an imminently hazardous situation, which, if not avoided, may result in death or serious injury.

NOTE: (Without Safety Alert Symbol) Indicates a situation that may result in property damage.











⚠ WARNING: To ensure safety and reliability, all repairs should be performed by a qualified service technician at Sears Service Center.



⚠ WARNING: The operation of any power tool can result in foreign objects being thrown into your eyes, which can result in severe eye damage. Before beginning power tool operation, always wear safety goggles or safety glasses with side shield and a full face shield when needed. We recommend a Wide Vision Safety Mask for use over eyeglasses or standard safety glasses with side shields. Always use eye protection which is marked to comply with ANSI Z87.1.

SAVE THESE INSTRUCTIONS

Some of the following symbols may be used on this tool. Please study them and learn their meaning. Proper interpretation of these symbols will allow you to operate the tool better and more safely.

SYMBOL	NAME	DESIGNATION/EXPLANATION
V	Volts	Voltage
A	Amperes	Current
Hz	Hertz	Frequency (cycles per second)
W	Watt	Power
min	Minutes	Time
~	Alternating Current	Type of current
==	Direct Current	Type or a characteristic of current
n_0	No Load Speed	Rotational speed, at no load
	Class II Construction	Double-insulated construction
.../min	Per Minute	Revolutions, strokes, surface speed, orbits, etc., per minute
	Wet Conditions Alert	Do not expose to rain or use in damp locations.
	Read The Operator's Manual	To reduce the risk of injury, user must read and understand operator's manual before using this product.
	Eye Protection	Always wear safety goggles or safety glasses with side shields and a full face shield when operating this product.
	Safety Alert	Precautions that involve your safety.
	No Hands Symbol	Failure to keep your hands away from the blade will result in serious personal injury.
	No Hands Symbol	Failure to keep your hands away from the blade will result in serious personal injury.
	No Hands Symbol	Failure to keep your hands away from the blade will result in serious personal injury.
	No Hands Symbol	Failure to keep your hands away from the blade will result in serious personal injury.
	Hot Surface	To reduce the risk of injury or damage, avoid contact with any hot surface.

SAFETY INSTRUCTIONS

⚠ WARNING: Read and understand all instructions. Failure to follow all instructions listed below may result in electric shock, fire, and/or serious personal injury. The term “power tool” in all of the warnings below refers to corded power tools or battery-operated (cordless) power tools.

READ AND SAVE THESE INSTRUCTIONS

- **Know your Worklight.** Read the operator’s manual carefully. Learn the worklight’s applications and limitations, as well as the specific potential hazards related to this Worklight. Following this rule will reduce the risk of electric shock, fire, or serious injury.
- **Use only the recommended the battery pack and charger.** Any attempt to use another battery pack will cause damage to the Worklight; it could possibly explode or cause a fire or personal injury.
- **Use battery only with charger listed.**

BATTERY PACK	CHARGER
320.11221	320.10006

- **Remove the battery pack from the Worklight** before performing any routine maintenance or cleaning.
- **Do not disassemble the Worklight.**
- **Do not place the Worklight or battery pack near fire or heat.** They may explode.
- **Do not dispose of a worn out battery pack by incinerating.** Do not incinerate the battery, even if it is severely damaged or completely worn out. The battery may explode in fire.
- **Do not operate the Worklight or the charger near flammable liquids or in a gaseous or explosive environment.** Internal sparks may ignite fumes.
- **To reduce the risk of electric shock,** do not put the Worklight, battery or charger in water or other liquid. Do not place or store the product where it can fall or be pulled into a tub or sink.
- **Do not store the Worklight in a damp or wet location. Do not store in locations where temperature is less than 32°F (0°C) or more than 104°F (40°C).** Do not store outside or in vehicles.
- **Do not permit children to use the Worklight;** it is not a toy
- **The Worklight LEDs may produce sufficient heat to melt some fabrics.** To avoid serious personal injury, keep the Worklight LEDs free from contact with other items.

- **Keep the Worklight dry, clean and free from oil and grease.** Always use a clean cloth when cleaning. Never use brake fluids, gasoline, petroleum-based products, or any strong solvent to clean the Worklight.
- **Do not expose the Worklight to rain or wet conditions.** Water entering the Worklight will increase the risk of electric shock.

ELECTRICAL SAFETY

- **Avoid body contact with grounded surfaces,** such as pipes, radiators, ranges, and refrigerators. There is an increased risk of electric shock if your body is grounded.
- **Power tool plugs must match the outlet.** Never modify the plug in any way. Do not use any adapter plugs with grounded power tools. Unmodified plugs and matching outlets will reduce the risk of electric shock.
- **Do not expose power tools to rain or wet conditions.** Water entering a power tool will increase the risk of electric shock.
- **Do not abuse the cord.** Never use the cord for carrying, pulling, or unplugging the power tool. Keep the cord away from heat, oil, sharp edge, or moving parts. Damaged or entangled cords increase the risk of electric shock.
- **When operating a power tool outdoors, use an extension cord suitable for outdoor use.** Use of a cord suitable for outdoor use reduces the risk of electric shock.

PERSONAL SAFETY

- **Stay alert, watch what you are doing and use common sense when operating a power tool.** Do not use a power tool while you are tired or under the influence of drugs, alcohol or medication. A moment of inattention while operating power tools may result in serious personal injury.
- **Use safety equipment. Always wear eye protection.** Safety equipment such as dust masks, non-skid safety shoes, hard hat or hearing protection used for appropriate conditions will reduce personal injuries.
- **Avoid accidental starting.** Ensure the switch is in the off position before plugging in. Carrying power tools with your finger on the switch or plugging in power tools that have the switch on invites accidents.
- **Remove any adjusting key or wrench before turning the power tool on.** A wrench or key left attached to a rotating part of the power tool may result in personal injury.
- **Do not overreach. Keep proper footing and balance at all times.** This enables better control of the power tool in unexpected situations.
- **Dress properly. Do not wear loose clothing or jewelry. Keep your hair, clothing and gloves away from moving parts.** Loose clothes, jewelry or long hair can be caught in moving parts.

- **If devices are provided for the connection of dust extraction and collection facilities, ensure these are connected and properly used.** Use of these devices can reduce dust-related hazards.
- **Use clamps or another practical way to secure and support the work-piece to a stable platform.** Holding the work by hand or against your body leaves it unstable and may lead to loss of control.
- **Do not use on a ladder or unstable support.** Stable footing on a solid surface enables better control of the power tool in unexpected situations.
- **Keep handles dry, clean and free from oil and grease.** Slippery hands can not safely control the power tool.
- **Always wear safety glasses with side shields.** Everyday glasses have only impact resistant lenses. They are NOT safety glasses. Following this rule will reduce the risk of eye injury.
- **Protect your lungs. Wear a face or dust mask if the operation is dusty.** Following this rule will reduce the risk of serious personal injury.
- **Protect your hearing.** Wear hearing protection during extended periods of operation. Following this rule will reduce the risk of serious person injury.

POWER TOOL USE AND CARE

- **Do not force the power tool.** Use the correct power tool for your application. The correct power tool will do the job better and safer at the rate for which it was designated.
- **Do not use the power tool if the switch does not turn it on and off.** Any power tool that cannot be controlled with the switch is dangerous and must be repaired.
- **Disconnect the plug from the power source and/or the batter pack from the power tool before making any adjustments, changing accessories or storing power tools.** Such preventive safety measures reduce the risk of starting the power tool accidentally.
- **Store idle power tools out of the reach of children and do not allow persons unfamiliar with the power tool or these instructions to operate the power tool.** Power tools are dangerous in the hands of untrained users.
- **Maintain power tools. Check for misalignment or binding of moving parts, breakage of parts and any other condition that may affect the power tool's operation.** If damaged, have the power tool repaired before use. Many accidents are caused by poorly maintained power tools.
- **Keep cutting tools sharp and clean.** Properly maintained cutting tools with sharp cutting edges are less likely to bind and are easier to control.
- **Use the power tool, accessories and tool bits etc., in accordance with these instructions and in the manner intended for the particular type of power tool, taking in account the working conditions and the work**

to be performed. Use of the power tool for operations different from those intended could result in a hazardous situation.

- **Hold power tools by insulated gripping surfaces when performing an operation where the cutting tool may contact hidden wiring or its own cord.** Contact with a “live” wire will also make exposed metal parts of the tool “live” and shock the operator.
- **Know your power tool. Read the product manual carefully. Learn its applications and limitations, as well as the specific potential hazards related to this tool.** Following this rule will reduce the risk of electric shock, fire or serious injury.
- **Save these instructions.** Refer to them frequently and use them to instruct others who may use this tool. If you loan someone this tool, also loan them these instructions.

BATTERY TOOL USE AND CARE

- **Make sure that the switch is in the OFF position before inserting the battery pack.** Inserting the battery pack into power tools that have the switch ON invites accidents.
- **Recharge only with the charger specified by the manufacturer.** A charger that is suitable for one type of battery pack may create a risk of fire when used with another battery pack.
- **Use power tools only with specifically designated battery packs.** Use of any other battery packs may create a risk of injury and fire.
- **When the battery pack is not in use, keep it away from other metal objects,** such as paper clips, coins, keys, nails screws, or other small metal objects that can make a connection from one terminal to another. Shorting the battery terminals together may cause burns or a fire.
- **If contact accidentally occurs, flush with water. If liquid contacts eyes, seek medical help.** Liquid ejected from the battery may cause irritation or burns.
- **Battery tools do not have to be plugged into an electrical outlet; therefore, they are always in operating condition.** Be aware of possible hazards when not using your battery tool or when changing accessories. Following this rule will reduce the risk of electric shock, fire, or serious personal injury.
- **Do not place battery tools or their batteries near fire or heat.** This will reduce the risk of explosion and possible injury.
- **Do not crush, drop or damage the battery pack.** Do not use a battery pack or charger that has been dropped or received a sharp blow.
- **A damaged battery is subject to explosion.** Properly dispose of a dropped or damaged battery immediately.

- **Batteries vent hydrogen gas and can explode in the presence of a source of ignition**, such as a pilot light. To reduce the risk of serious personal injury, never use any cordless product in the presence of open flame. An exploded battery can propel debris and chemicals. If exposed to such debris or chemicals, immediately flush the exposed area with water.
- **Do not charge a battery tool in a damp or wet location.** Following this rule will reduce the risk of electric shock.
- **Under extreme usage or temperature conditions, battery leakage may occur.**
- **If liquid comes in contact with your skin**, wash immediately with soap and water, then neutralize with lemon juice or vinegar.
- **If liquid from the battery gets in your eyes**, flush them with clean water for at least 10 minutes, and then seek immediate medical attention. Following this rule will reduce the risk of serious personal injury.

SERVICE

- **Have your worklight serviced by a qualified repair person using only identical replacement parts.** This will ensure that the safety of the worklight is maintained.
- **When servicing the worklight, use only identical replacement parts.**

Follow instructions in the Maintenance section of this manual.

⚠ WARNING: To reduce the risk of injury, user must read instruction manual.

SPECIFIC SAFETY RULES FOR WORKLIGHT

- **Know your worklight. Read operator's manual carefully.** Learn the applications and limitations, as well as the specific potential hazards related to this tool. Following this rule will reduce the risk of electric shock, fire or serious injury.
- **Do not stare into the LED worklight directly.** Avoid direct eye contact; never project the worklight to others' eyes. Failure to do so will lead serious personal injury.
- **Battery tools do not have to be plugged into an electrical outlet; therefore, they are always in operating condition. Be aware of possible hazards when not using your battery tool or when changing accessories.** Following this rule will reduce the risk of electric shock, fire or serious personal injury.
- **Do not place battery tools or their batteries near fire or heat.** This will reduce the risk of explosion and possibly injury.
- **Do not crush, drop or damage battery pack. Do not use a battery pack or charger that has been dropped or received a sharp blow.** A damaged

battery is subject to explosion. Properly dispose of a dropped or damaged battery immediately.

- **Batteries vent hydrogen gas and can explode in the presence of a source of ignition such as a pilot light.** To reduce the risk of serious personal injury, never use any cordless product in the presence of open flame. An exploded battery can propel debris and chemicals. If exposed, flush with water immediately.
- **Do not charge battery tool in a damp or wet location.** Following this rule will reduce the risk of electric shock.
- **For best results, your battery tool should be charged in a location where the temperature is more than 32°F (0°C) but less than 104°F (40°C).**
- **Do not store outside or in vehicles.**
- **Under extreme usage or temperature conditions, battery leakage may occur.** If liquid comes in contact with your skin, wash immediately with soap and water, then neutralize with lemon juice or vinegar. If liquid gets in your eyes, flush them with clean water for at least 10 minutes, then seek immediate medical attention. Following this rule will reduce the risk of serious personal injury.
- **Save these instructions.** Refer to them frequently and use them to instruct others who may use this tool. If you loan someone this tool, also loan them these instructions.
- **If the power supply cord is damaged,** it must be replaced only by the manufacturer or by an authorized service center to avoid risk.

 **CAUTION!** Hot Surface.

 **Risk of Burns-**Do Not Touch.

 **Risk of Fire-**Keep Away From Combustible Materials.

 **WARNING:** Read and understand all instructions. Failure to follow all instructions listed below may result in electric shock, fire, and/or serious personal injury.

- **Before using the battery charger,** read all instructions and cautionary markings in this manual and on the battery charger, the battery and the product using the battery to prevent misuse of the products and possible injury or damage.

 **CAUTION:** To reduce the risk of electric shock or damage to the charger and battery, charge only those lithium-ion rechargeable batteries specifically designated on your charger's label. Other types of batteries may burst, causing personal injury or damage.

- **Do not use the charger outdoors or expose it to wet or damp conditions.**

Water entering the charger will increase the risk of electric shock.

- **Use of an attachment not recommended or sold by the battery-charger manufacturer may result in a risk of fire, electric shock or injury to persons.**
- **Do not abuse the cord or charger.** Never use the cord to carry the charger. Do not pull the charger cord to disconnect the plug from the electrical receptacle. Damage to the cord or charger could occur and create an electric shock hazard. Replace damaged cords immediately.
- **Make sure that the cord is located so that it will not be stepped on, tripped over, come in contact with sharp edges or moving parts, or otherwise subjected to damage or stress.** This will reduce the risk of accidental falls, which could cause injury and damage to the cord, which could then result in electric shock.
- **Keep the cord and charger from heat** to prevent damage to housing or internal parts.
- **Do not allow gasoline, oils, petroleum-based products, etc. to come in contact with plastic parts.** These materials contain chemicals that can damage, weaken, or destroy plastic.
- **An extension cord should not be used unless absolutely necessary.** Use of an improper extension cord could result in a risk of fire and electric shock. If an extension cord must be used, make sure that:

The pins on plug of extension cord are the same number, size and shape as those of the plug on charger.

The cord is properly wired and in good electrical condition

The size is large enough for AC ampere rating of charger as specified below:

The Cord Length (Feet)	25'	50'	100'
Cord Size (AWG)	6	16	16

NOTE: AWG = American Wire Gauge

- **Do not operate the charger with a damaged cord or plug,** which could cause shorting and electric shock. If damaged, have the charger repaired or replaced by an authorized service technician at a Sears Service Center.
- **Do not operate the charger** if it has received a sharp blow, been dropped, or has otherwise been damaged in any way. Take it to an authorized service technician at Sears Service Center for an electrical check to determine if the charger is in good working order.
- **Do not disassemble the charger.** Take it to an authorized service technician at a Sears Service Center when service or repair is required. Incorrect reassembly may result in a risk of electric shock or fire.
- **Unplug the charger** from the electrical outlet before attempting any

maintenance or cleaning to reduce the risk of electric shock.

- **Disconnect the charger from the power supply when not in use.** This will reduce the risk of electric shock or damage to the charger if metal items should fall into the opening. It will also help prevent damage to the charger during a power surge.
- **Risk of electric shock.** Do not touch the uninsulated portion of output connector or uninsulated battery terminal.
- **Save these instructions.** Refer to them frequently and use them to instruct others who may use this tool. If you lend this tool to someone else, also lend these instructions to them to prevent misuse of the product and possible injury.

IMPORTANT SAFETY INSTRUCTIONS

- **Save these instructions.** This manual contains important safety and operating instructions for battery charger 320.10006 and battery pack 320.11221.
- **Before using the battery charger,** read all instructions and cautionary markings on the battery charger, the battery and the product using battery.
- **CAUTION.** To reduce the risk of injury, charge only lithium-ion rechargeable batteries. Other types of batteries may burst, causing personal injury or damage.
- **WARNING.** When using electric appliances, basic precautions should always be followed, including the following.
 - a) To reduce the risk of injury, close supervision is necessary when an appliance is used near children.
 - b) Only use attachments recommended or sold by manufacturer.
 - c) Do not use outdoors.
 - d) For a portable appliance – To reduce the risk of electrical shock, do not put Worklight and Battery Pack in water or other liquid. Do not place or store appliance where or can fall or be pulled into a tub or sink.

DESCRIPTION

KNOW YOUR LED WORKLIGHT (Fig.1)

⚠ WARNING: The safe use of this product requires an understanding of the information on the tool and in this operator's manual as well as knowledge of the project you are attempting. Before use of this product, familiarize yourself with all operating features and safety rules.

HANDLE PIVOT

The adjustable head pivots 135° and allows for precise positioning of the light beam.

EXTENDED RUN-TIME

Up to 5 hours of illumination from a fully-charged battery pack.

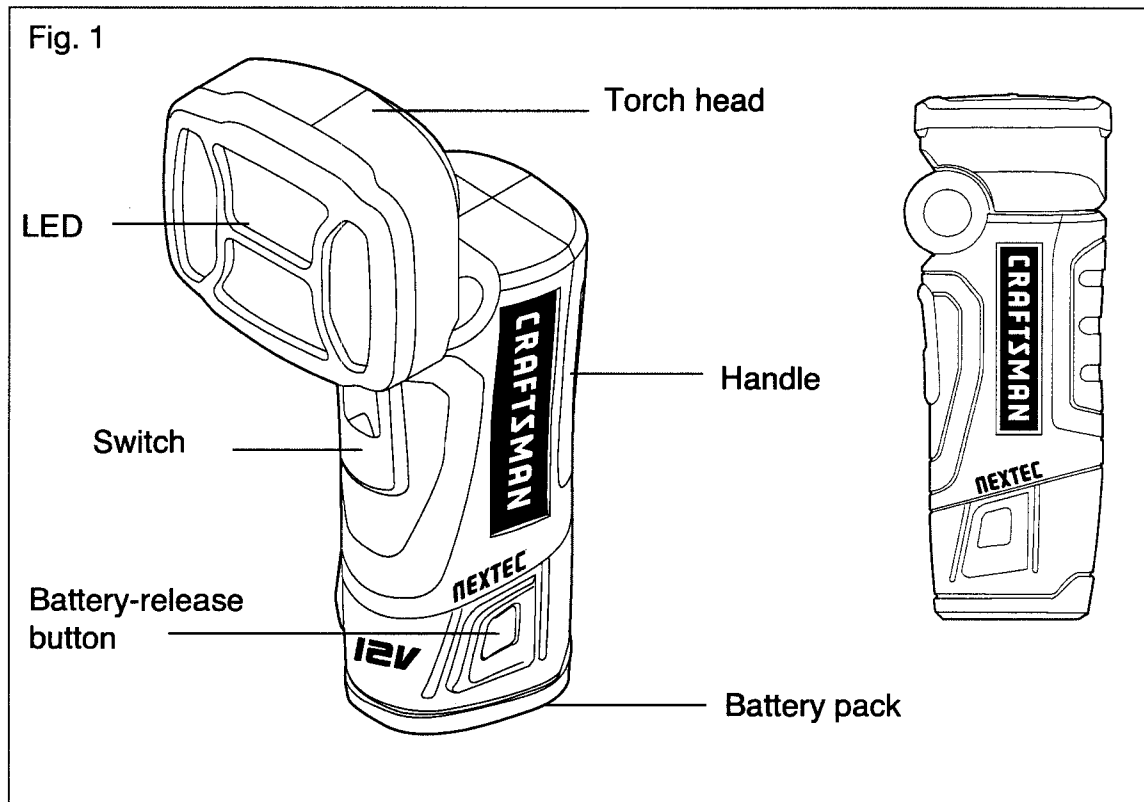

PRODUCT SPECIFICATIONS	
Illumination Source	24 Light Emitting Diodes (LED)
Head Pivot	135°
Bulb Power	12V 240mA
Run-time	Approximately 5 hrs.
Worklight Weight	0.77lbs (including battery)
Battery Type	Lithium-Ion
Battery Voltage	12.0 Volt DC
Charger Input	120-Volts, 60 Hz AC only
Optimum Charging Temperature	32°F (0° C) -104°F (40°C)

ASSEMBLY

⚠ WARNING: If any part is broken or missing, do not attempt to operate the worklight until the broken or missing part is replaced. Failure to do so could result in possible serious injury.

⚠ WARNING: Do not attempt to modify this worklight or create accessories not recommended for use with this worklight. Any such alteration or modification is misuse and could result in a hazardous condition leading to possible serious injury.

UNPACKING

This product has been shipped completely assembled.

- Carefully remove the tool and any accessories from the box. Make sure that all items listed in the packing list are included.
- Inspect the tool carefully to make sure that no breakage or damage occurred during shipping.
- Do not discard the packing material until you have carefully inspected and satisfactorily operated the tool.
- If any part is damaged or missing, please refer to the numbers listed on the back page of operator's manual.

PACKING LIST

LED Worklight

Operator's Manual

OPERATION

BATTERY PROTECTION

The battery circuitry protects the battery pack from extreme temperature, over-discharge, and over-charge. To protect the battery from damage and prolong its life, the battery pack circuitry will turn off the battery pack if it becomes overloaded or if the temperature becomes too high during use. This may happen in extremely high torque, binding, and stalling situations. This intelligent system will shut down your battery pack if its operating temperature exceeds 176°F (80°C) and will begin normal operation when it returns to 32°F (0°C) - 122°F (50°C).

NOTE: A significantly reduced run time after fully charging the battery pack indicates that the batteries are near the end of their usable life and must be replaced.

COLD WEATHER OPERATION

This Lithium-Ion battery pack will provide optimal performance in temperatures between 32°F (0°C) and 104°F (40°C). When the battery pack is very cold, it may "pulse" for the first minute of use to warm itself up. Put the battery pack on a

tool and use the tool in a light application. After about a minute, the battery pack will have warmed itself up and will operate normally.

WHEN TO CHARGE THE BATTERY PACK

It is not necessary to run down the battery pack charge before recharging. The Lithium-Ion battery can be charged at any time; it will not develop a “memory” when charged after only a partial discharge.

Remove the battery pack from the tool when convenient for you and your job. “Top off” the battery pack charge by charging it for a time before starting a big job or long period of use.

Due to Lithium-Ion fade-free properties, the only time it is necessary to charge the Lithium-Ion battery pack is when the pack has reached the end of its charge. To signal the end of charge, power to the tool will drop quickly. Charge the battery pack as needed.

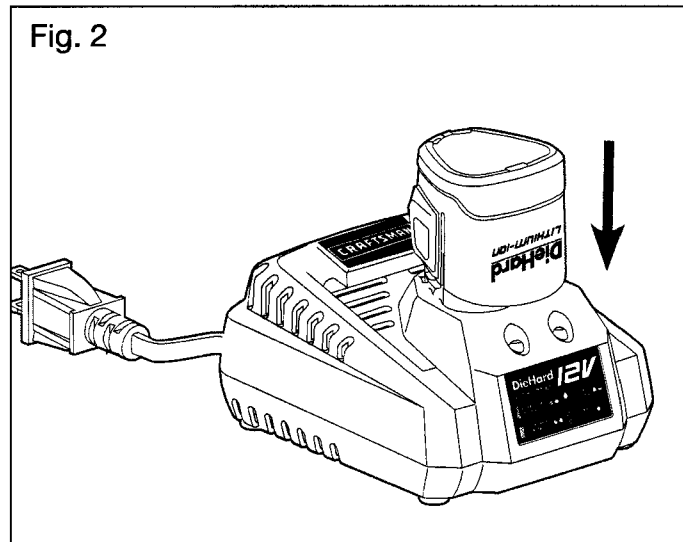

HOW TO CHARGE THE BATTERY PACK









NOTE: This Lithium-Ion battery pack is shipped partially charged. Before using it for the first time, fully charge the battery pack.

A fully discharged battery pack will charge in about 30 minutes in a surrounding temperature between 32° F (0° C) and 104° F (40° C).

1. Charge the Lithium-Ion battery pack with the correct charger.
2. Connect the charger to a power supply.
3. Align the raised ribs of the battery pack with the slot in the charger.
4. Insert the battery pack into the charger (Fig. 2)
5. The charger will communicate with the battery pack to evaluate the condition of the battery pack.
6. The green lights will flash while the battery pack is charging. After charging is complete, the green LED on the charger will be on. The flickering red light indicates a defective battery or a bad connection between the battery and the charger.
7. The battery pack will fully charge if left on the charger, but it will not overcharge.

NOTE: For your convenience, the charger can operate with most generators and inverters rated at 300 watts or higher.

LED FUNCTIONS OF CHARGER (Fig. 3)

LED INDICATOR	BATTERY PACK	RED LED	GREEN LED	ACTION
 HI/LO TEMP. (SEE MANUAL) 	Hot/Cold battery	On	Off	Charging will begin when battery returns to 32°F (0°C)-104°F (40°C)
 DEFECTIVE BATTERY 	Defective	Flashing	Off	Battery pack or Charger/Adapter is defective
 BATTERY CHARGING 	Charging	Off	Flashing	Charging
 BATTERY FULL 	Fully charged	Off	On	Charging is complete Maintenance charging

CHARGING A HOT BATTERY PACK

If the battery pack is above normal temperature range, the red LED will illuminate and the green LED will be off. When the battery pack cools down to approximately 104°F (40°C), the charger will automatically begin charging.

CHARGING A COLD BATTERY PACK

If the battery pack is below the normal temperature range, the red LED will illuminate and the green LED will be off. When the battery warms to a temperature of more than 32°F (0°C), the charger will automatically begin charging.

DEFECTIVE BATTERY

If the charger detects a problem, the red LED will begin flashing and the green LED will be off.

1. If registering as defective, remove and reinsert the battery pack in the charger. If the LED status reads “defective” a second time, try charging a different battery pack.
2. If a different battery pack charges normally, dispose of the defective battery pack (see Maintenance section).
3. If a different battery pack also indicates “defective,” the charger may be defective.

BATTERY CHARGING

If the battery pack is being charged within a normal surrounding temperature range (32° F to 104° F), the green LED will begin flashing and the red LED will be off. The battery pack will reach a full charge in 30 minutes.

BATTERY FULL

If the battery pack is within normal temperature range, the green LED will illuminate and the red LED will be off. The battery pack is fully charged and ready to use. The battery pack will fully charge, but will not overcharge, if left on the charger.

NOTE: Charger may warm with several continuous charge cycles. This is part of the normal operation of the charge. Charge in a well ventilated area.

TO ATTACH BATTERY PACK TO THE TOOL (Fig. 4)

1. Make sure that the Worklight is "OFF".
2. Align the raised rib on the battery pack with the grooves of the Worklight, then attach the battery pack to the Worklight.

Make sure that the latch on the battery pack snaps into place and the battery pack is secured to the tool before beginning operation.

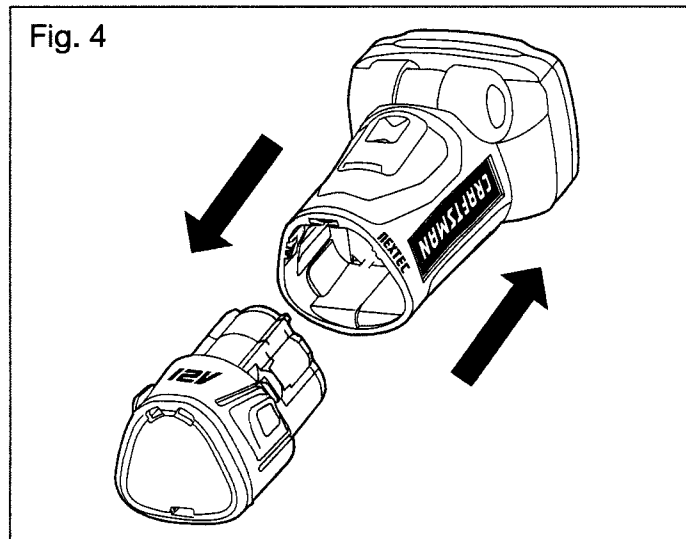

TO DETACH BATTERY PACK (Fig. 4)

1. Depress the battery release button located on the both sides of the battery pack to release battery pack.
2. Pull battery pack out and remove it from the tool.

⚠ CAUTION: When placing the battery pack in the tool, be sure that the raised rib on the battery pack aligns with the groove inside the Worklight and the latches snap into place properly. Improper assembly of the battery pack can cause damage to internal components.

TURN ON/OFF THE WORKLIGHT

Depress the switch to turn on the worklight, depress again to turn off.

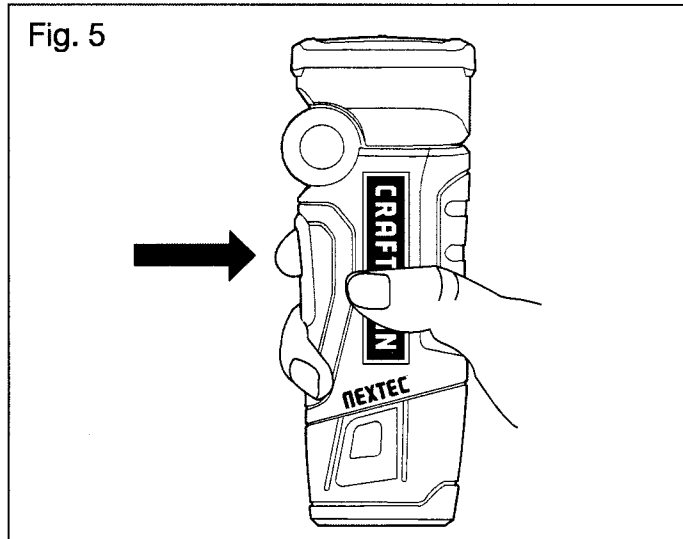

ADJUSTING THE WORKLIGHT HEAD (Fig.6)

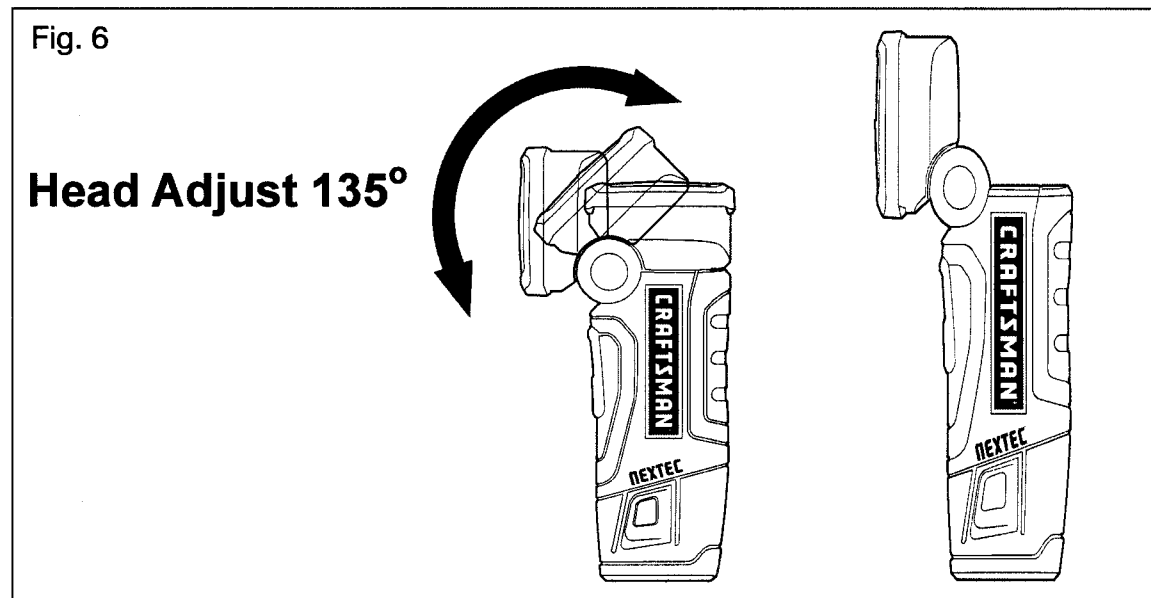

The worklight head independently pivots 135° for maximum flexibility.

Move the head by manually adjusting to any position within the 135° pivot range. Do not force the head beyond the 135° range.

⚠ WARNING: When servicing, use only identical Craftsman replacement parts. Use of any other parts may create a hazard or cause product damage.

⚠ WARNING: Always wear safety goggles or safety glasses with side shields when using compressed air to clean the tool. If the operation is dusty, also wear a dust mask.

⚠ WARNING: To avoid serious personal injury, always remove the battery pack from the tool when cleaning or performing any maintenance.

MAINTENANCE

GENERAL MAINTENANCE

Avoid using solvents when cleaning plastic parts. Most plastics are susceptible to damage from various types of commercial solvents and may be damaged by their use. Use clean cloths to remove dirt, dust, oil, grease, etc.

⚠ WARNING: Do not at any time let brake fluids, gasoline, petroleum-based products, penetrating oils, etc. come in contact with plastic parts. Chemicals can damage, weaken or destroy plastic which may result in serious personal injury.

Only the parts shown in the parts list are intended to be repaired or replaced by the customer. All other parts should be replaced at a Sears Service Center.

BATTERIES:

The batteries in this tool have been designed to provide maximum trouble-free life. Like all batteries, they will eventually wear out. Do not disassemble the battery pack or attempt to replace the batteries. Handling of the batteries, especially when wearing rings and jewelry, could result in a serious burn.



To obtain the longest possible battery life, read and understand the operators manual.

- It is good practice to unplug the Charger/Adapter and remove the Lithium-Ion battery pack when not in use.
For Lithium-Ion battery pack storage longer than 30 days:
- Store the Lithium-Ion battery pack where the temperature is below 80°F (26°C) and free of moisture.
- Store Lithium-Ion battery packs in a 30%-50% charged condition.
- Every six months of storage, fully charge the Lithium-Ion battery pack.
- Exterior may be cleaned with a cloth or soft non-metallic brush.

BATTERY PACK REMOVAL AND PREPARATION FOR RECYCLING

To preserve natural resources, please recycle or dispose of batteries properly. This product contains lithium-ion batteries. Local, state or federal laws may prohibit disposal of lithium-ion batteries in ordinary trash. Consult your local waste authority for information regarding available recycling and/or disposal options.

⚠ WARNING: Upon removal of the battery pack for disposal or recycling, cover the battery pack's terminals with heavy-duty adhesive tape. Do not attempt to destroy or disassemble the battery pack or remove any of its components. Lithium-Ion batteries must be recycled or disposed of properly.

Also, never touch the terminals with metal objects and/or body parts as a short circuit may result. Keep away from children. Failure to comply with these warnings could result in fire and/or serious injury.

EXPLODED VIEW

12.0 VOLT LITHIUM-ION CORDLESS LED WORKLIGHT MODEL NUMBER 320.10005

The Model Number will be found on the Nameplate attached to the handle of the Worklight. Always mention the Model Number in all correspondence regarding your tool

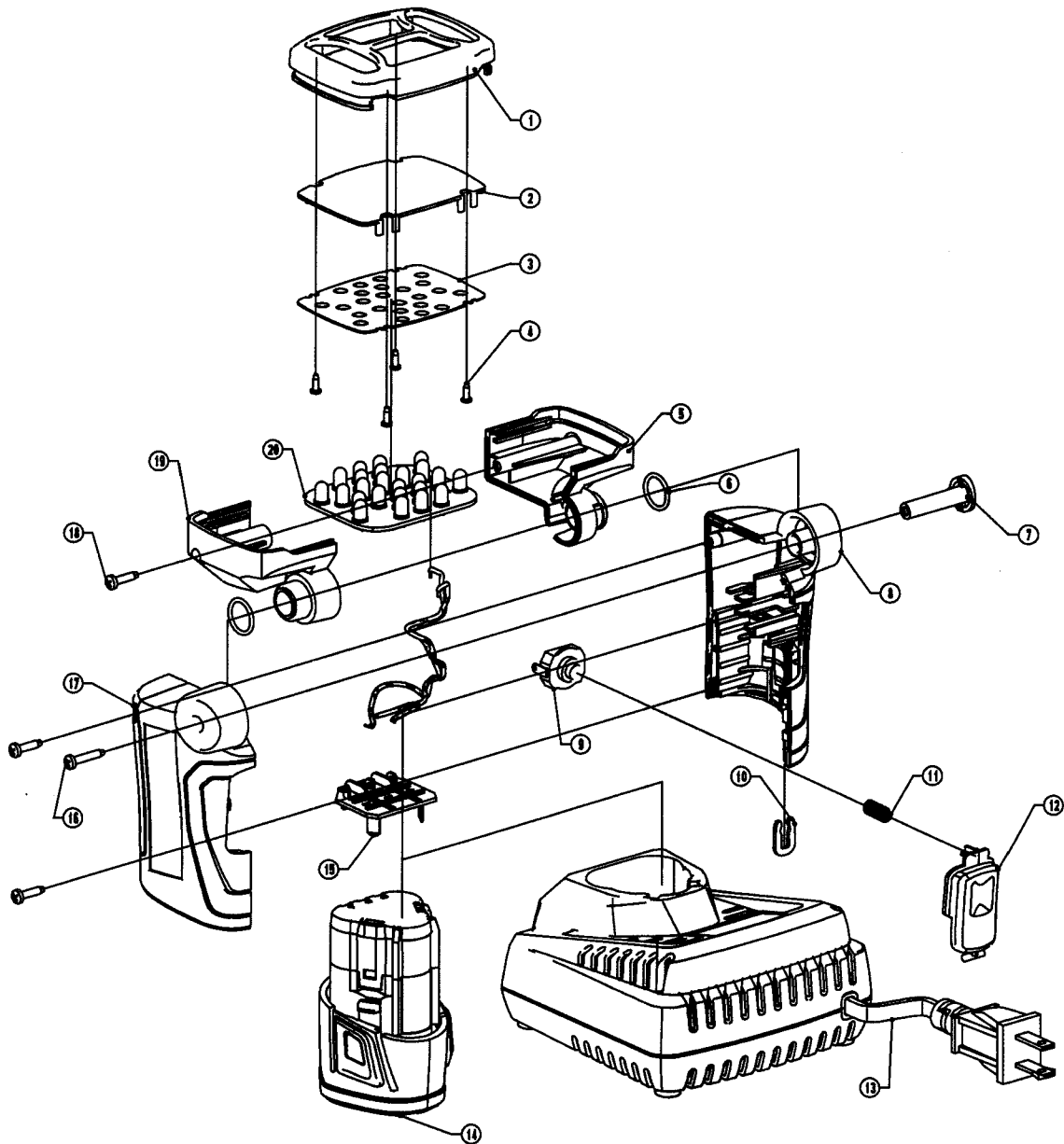

PARTS LIST

No	Part No	Part Name	QTY
1	3124231000	Led Cover	1
2	3124229000	Transparent Guard	1
3	3704266000	Reflector	1
4	5610005000	Tapping Screw	4
5	3124230000	Right Indicator Cover	1
6	5690128000	O Ring	2
7	3124233000	Connecting Lever	1
8	3320706000	Right Handle Assy	1
9	4870384000	Push Switch	1
10	3704254000	Handle Hoop	1
11	3660010000	Spring	1
12	3124232000	Switch Button	1
13	220018000	5307 Charger Tools	1
14	2770153000	5120 Power Pack	1
15	3402298000	Contact Receptacle Assy	1
16	5610096000	Tapping Screw	1
17	3320705000	Left Handle Assy	1
18	5610012000	Tapping Screw	3
19	3124228000	Left Indicator Cover	1
20	4890438000	Pcb Assembly	1

NOTES



NOTES

Get it fixed, at your home or ours!

Your Home

For expert troubleshooting and home solutions advice:

manage my home

www.managemyhome.com

For repair – **in your home** – of **all** major brand appliances, lawn and garden equipment, or heating and cooling systems, **no matter who made it, no matter who sold it!**

For the replacement parts, accessories and owner's manuals that you need to do-it-yourself.

For Sears professional installation of home appliances and items like garage door openers and water heaters.

1-800-4-MY-HOME®

(1-800-469-4663)

www.sears.com

Call anytime, day or night

(U.S.A. and Canada)

www.sears.ca

Our Home

For repair of carry-in items like vacuums, lawn equipment, and electronics, call anytime for the location of the nearest

Sears Parts & Repair Service Center

1-800-488-1222 (U.S.A.)

www.sears.com

1-800-469-4663 (Canada)

www.sears.ca

To purchase a protection agreement on a product serviced by Sears:

1-800-827-6655 (U.S.A.)

1-800-361-6665 (Canada)

Para pedir servicio de reparación a domicilio, y para ordenar piezas:

1-888-SU-HOGAR®

(1-888-784-6427)

Au Canada pour service en français:

1-800-LE-FOYER^{MC}

(1-800-533-6937)

www.sears.ca

Sears

© Sears Brands, LLC

® Registered Trademark / ™ Trademark / ™ Service Mark of Sears Brands, LLC

® Marca Registrada / ™ Marca de Fábrica / ™ Marca de Servicio de Sears Brands, LLC

^{MC} Marque de commerce / ^{MD} Marque déposée de Sears Brands, LLC