

ZUMIMALL™

Get Smarter About Your Security



X2

FCC ID: 2AZL7-ZS-GX1S

FHD Battery Security Camera QUICK START GUIDE

Welcome

Thank you for choosing ZUMIMALL. Please read this quick start guide carefully before using this product, for further information please scan the QR code below to download user manual on ZUMIMALL website.

Please scan the QR code to
get the detailed electronic manual.



English



German



French



Italian



Spanish



Japanese



Scan "zumimall" QR
code to purchase products



Follow @zumimalloffice
on Facebook



@zumimall



@zumimallcam



@zumimalloffice



@zumimallcamera

More About Us

Web: www.zumimall.com

Facebook: www.facebook.com/zumimalloffice

Amazon Store: www.amazon.com/zumimall

Product Service

Email: support@zumimall.com

Distributor: distributor@zumimall.com

Brand Story

Founded in 2008, Zumimall focuses on the design and research of intelligent security technology. Zumimall insists on taking consumer needs as its core and strives to create smart home products that lead a global home fashion trend for consumers. Zumimall believes that craftsmanship creates top quality and technology changes life. With high-quality products and first-class service, Zumimall won the love and trust of millions of customers as soon as it went public. Over the years, Zumimall has served 45 continents of America, covering 80% of the population. Zumimall is the provider of a smart lifestyle and a guardian of the wonderful moments of your life.

3 YEARS warranty

1V1 Customer Service

How to Activate it?

Send us Order number via email or Scan the QR Code

Email: support@zumimall.com



1. What's in the Box

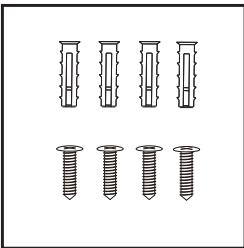
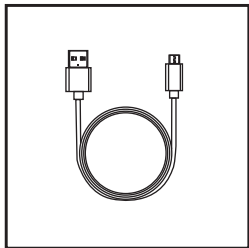
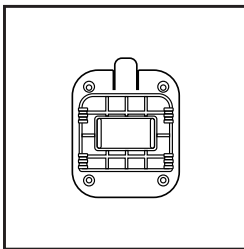
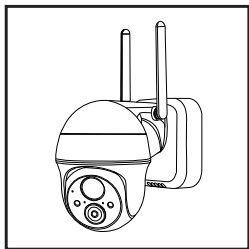

ZUMIMALL Battery Camera * 1

Quick User Guide *1

Screws Set *1

Outdoor Mount *1

Charging Cable *1

NOTE: Micro SD card and power adapter are not included.

2. Product Diagram

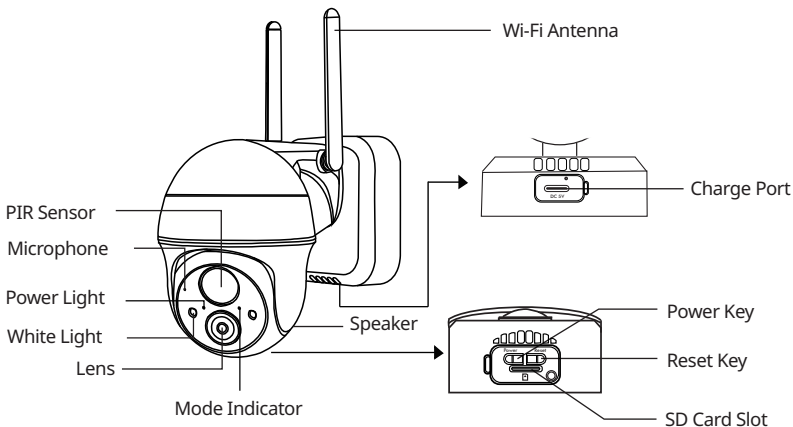

Power Button	Keep pressing for 5-10 seconds to power on/power off
Reset Button	Keep pressing for 5-10 seconds to reset
Blink Slowly in Red	Awaiting Wi-Fi connection, ready for adding devices
Blink Fast in Red	Wi-Fi connecting
Solid in Red	Network problem
Solid in Blue	Wi-Fi connected, camera running normally
Blink Slowly in Blue	Firmware update

3. Download and Install App

Download ZUMIMALL App from Google Play™ or App Store™.
Or scan the QR codes as below, with your smart phone.

NOTE: Google Play™ is a trademark of Google Inc.
App Store™ is a service mark of Apple Inc.



NOTE: Please turn on both of the following permissions.

- ① Allow ZUMIMALL App to access mobile cellular data and wireless LAN, otherwise it will fail to connect the camera.
- ② Allow ZUMIMALL App to receive pushed messages, otherwise, the phone will not receive alarms when motion is detected.

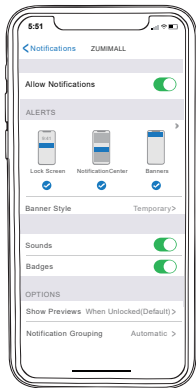
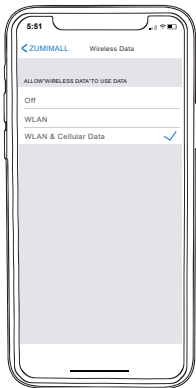

4. Account Registration

New user needs to sign up ZUMIMALL App with email address. Click 'Sign up' to create a New Account and follow the steps to complete registration.

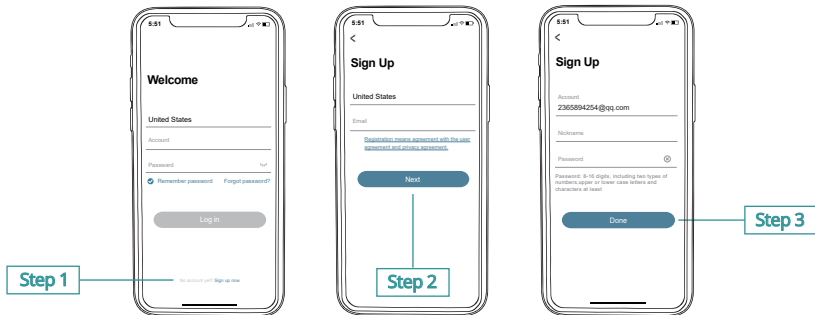

5. Add Camera to App

5.1 Preparations for connection

- ① Insert a Micro SD Card into the camera to save video clips or you can start the 7-day free cloud service. Without Micro SD Card or cloud service, no video will be saved.
- ② The camera only works with 2.4GHz Wi-Fi, not support 5GHz.
- ③ When connecting to the network, please take the camera close to the router (Recommended within 10-15ft).

5.2 Connect Camera to App



Tap 'Add Device'

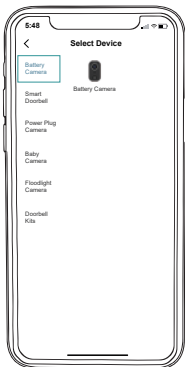

Select 'Battery Camera'

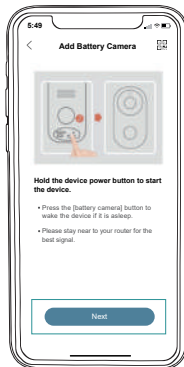

Turn on the Camera



Reset the Camera



Input Wi-Fi Password



Prepare the Scanning



Scan QR Code when Indicator Flashing Slowly in Red



Finished Installation When Reaches 100%

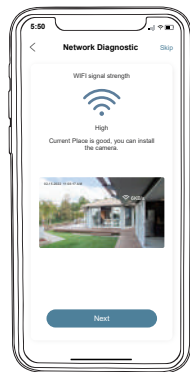

Perform Network Diagnosis

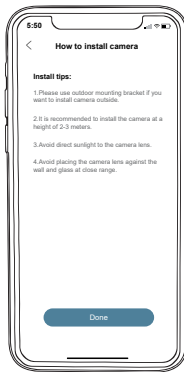

View Installation Tips

1. Was ist in der Box?

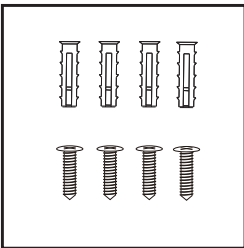
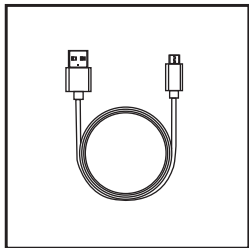
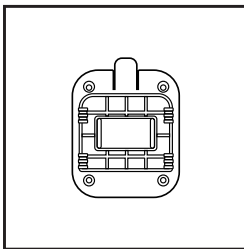
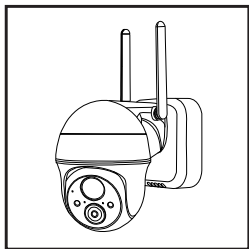

ZUMIMALL Akku-Kamera * 1

Kurzanleitung *1

Schraubensatz *1

Außenmontage *1

Aufladen-Kabel *1

HINWEIS: Micro-SD-Karte und Netzadapter sind nicht im Lieferumfang enthalten.

2. Produkt-Diagramm

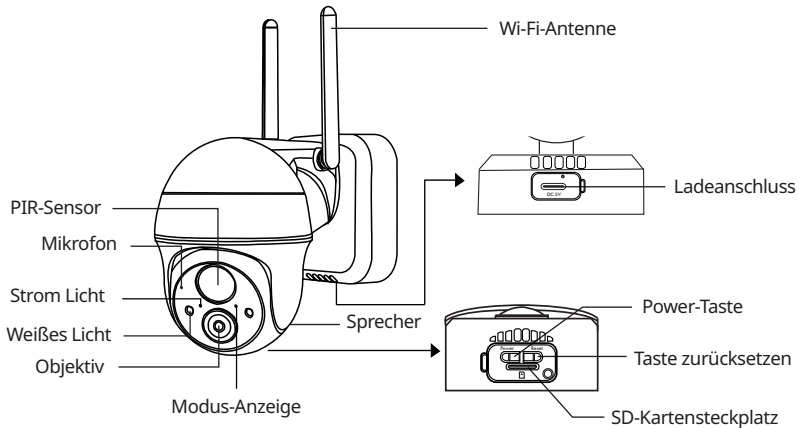

Einschalttaste	Halten Sie die Taste 5-10 Sekunden lang gedrückt, um das Gerät ein-/auszuschalten
Reset-Taste	Zum Zurücksetzen 5-10 Sekunden lang gedrückt halten
Langsames Blinken in Rot	Warten auf die Wi-Fi-Verbindung, bereit zum Hinzufügen von Geräten
Schnelles Blinken in Rot	Wi-Fi-Verbindung
Solide in Rot	Netzwerk-Problem
Solide in Blau	Wi-Fi verbunden, Kamera läuft normal
Langsames Blinzeln in Blau	Aktualisierung der Firmware

3. App herunterladen und installieren

Laden Sie die ZUMIMALL App von Google Play™ oder App Store™ herunter. Oder scannen Sie die QR-Codes wie unten, mit Ihrem Smartphone.

HINWEIS: Google Play™ ist eine Marke von Google Inc.
App Store™ ist eine Dienstleistungsmarke von Apple Inc.



HINWEIS: Bitte aktivieren Sie die folgenden beiden Berechtigungen.

- ① Erlauben Sie der ZUMIMALL App den Zugriff auf mobile Daten und Wireless LAN, sonst kann die Kamera nicht verbunden werden.
- ② Erlauben Sie der ZUMIMALL App, Push-Nachrichten zu empfangen, sonst wird das Telefon keine Alarme empfangen, wenn eine Bewegung erkannt wird.

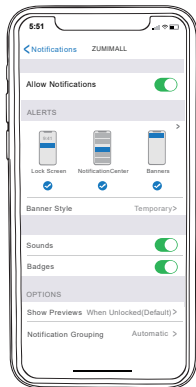
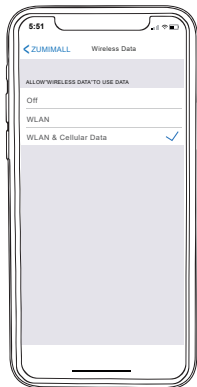

4. Registrierung eines Kontos

Neue Benutzer müssen die ZUMIMALL App mit ihrer E-Mail-Adresse registrieren. Klicken Sie auf 'Anmelden', um ein neues Konto zu erstellen und folgen Sie den Schritten, um die Registrierung abzuschließen.

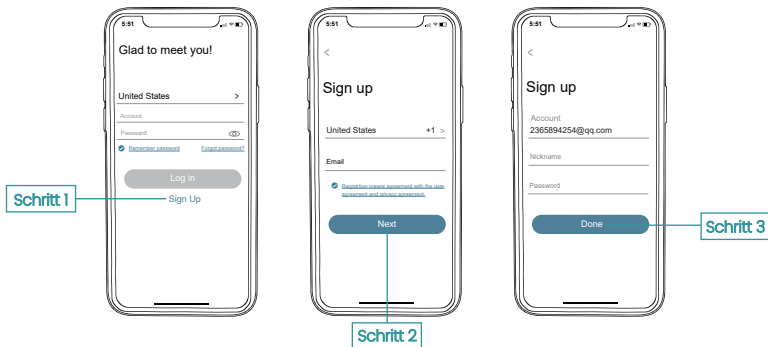

5. Kamera zur App hinzufügen

5.1 Vorbereitungen für den Anschluss

- ① Legen Sie eine Micro-SD-Karte in die Kamera ein, um Videoclips zu speichern, oder Sie können den den kostenlosen 7-Tage-Cloud-Service nutzen. Ohne Micro-SD-Karte oder Cloud-Service wird kein Video gespeichert werden.
- ② Die Kamera funktioniert nur mit 2.4GHz Wi-Fi, unterstützt aber nicht 5GHz.
- ③ Wenn Sie eine Verbindung zum Netzwerk herstellen, bringen Sie die Kamera bitte in die Nähe des Routers. (Empfohlen innerhalb von 10-15ft).

5.2 Kamera mit App verbinden



Tippen Sie auf 'Gerät hinzufügen'

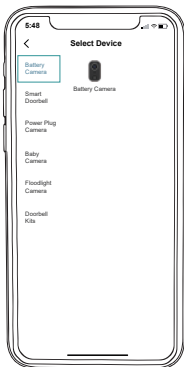

Wählen Sie 'Netzstecker Kamera'

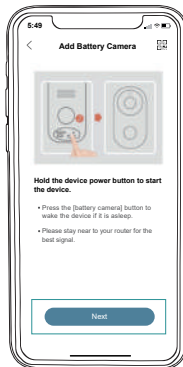

Schalten Sie die Kamera ein



Zurücksetzen der Kamera



Wi-Fi-Passwort eingeben



Vorbereiten des Scannens



QR-Code scannen, wenn die Anzeige Langsam rot blinkt



Abgeschlossene Installation
Wenn 100% erreicht sind

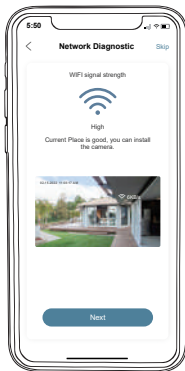

Netzwerkd Diagnose durchführen

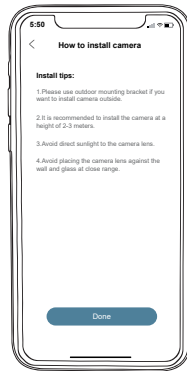

Installationstipps anzeigen

1. 箱の中身について

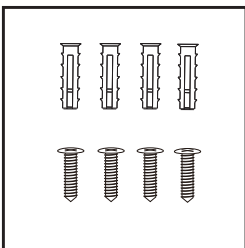
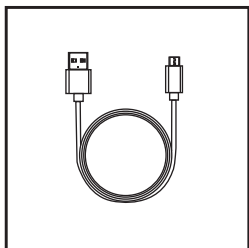
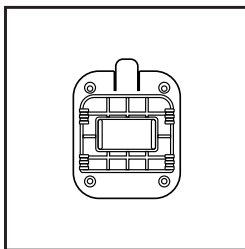
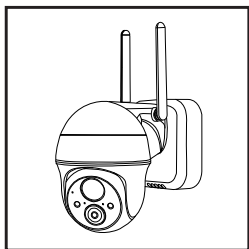

ZUMIMALL バッテリーカメラ * 1
クイック・ユーザー・ガイド * 1
ネジセット * 1

アウトドアマウント * 1
充電用ケーブル

注: マイクロSDカード、電源アダプターは付属していません。

2. 製品構成図

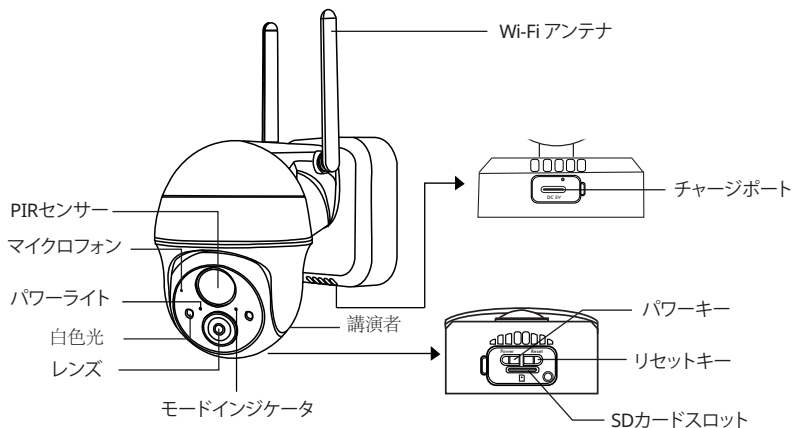

電源ボタン	5～10秒間押し続けて、電源オン／電源オフ
リセットボタン	5～10秒間押し続けるとリセットされます
赤色でゆっくり点滅する	Wi-Fi接続待ち、デバイスを追加できる状態
赤色で高速点滅	Wi-Fi接続
ソリッドインレッド	ネットワークの問題
ソリッドインブルー	Wi-Fi接続、カメラは正常に動作しています
ブルーにゆっくりと点滅する	ファームウェアのアップデート

3. アプリのダウンロードとインストール

Google Play™またはApp Store™からZUMIMALLアプリをダウンロードします。
または、下記のQRコードをスマートフォンで読み取ってください。

注： Google Play™はGoogle Inc.の商標です。

App Store™は、Apple Inc.のサービスマークです。



以下の権限を両方ともオンにしてください。

- ① ZUMIMALLアプリが携帯電話データおよび無線LANにアクセスすることを許可する、に設定しないと、カメラとの接続に失敗します。
- ② ZUMIMALLアプリでプッシュ型メッセージの受信を許可してください。
動体検知時にアラームを受信します。

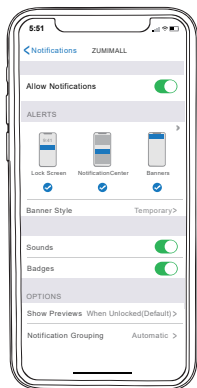
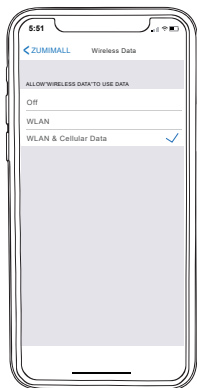

4. アカウント登録

新規でご利用の方は、メールアドレスでZUMIMALLアプリのサインアップが必要です。登録するをクリックして新規アカウントを作成し、手順に従って登録を完了します。

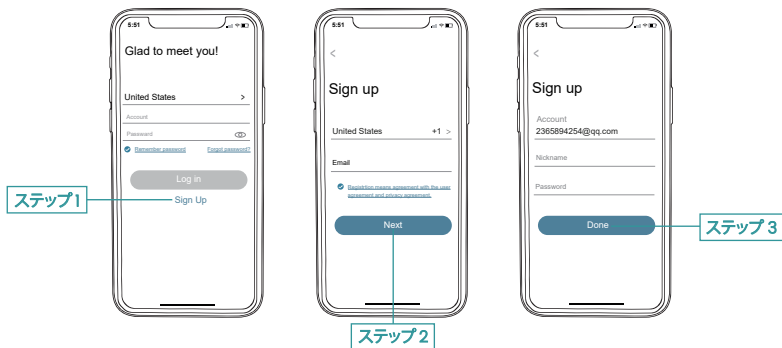

5. アプリにカメラを追加する

5.1 接続のための準備

- ① マイクロSDカードをカメラにセットして、動画を保存することもできます。7日間無料のクラウドサービスです。Micro SDカードやクラウドサービスがない場合は、動画はありません。は保存されます。
- ② カメラは2.4GHz帯のWi-Fiでのみ動作し、5GHz帯には対応していません。
- ③ ネットワークに接続する際は、カメラをルーターに近づけてください。(10-15ft以内を推奨)。

5.2 カメラをアプリに接続する



デバイスを追加する」
をタップする

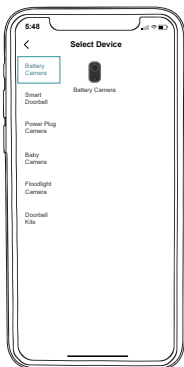

「バッテリーカメラ」を選択

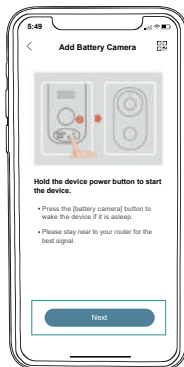

カメラを起動する

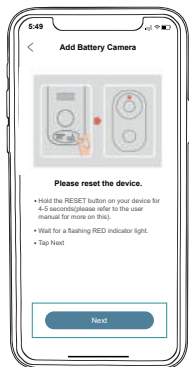

カメラをリセットする



Wi-Fiパスワードの入力



スキャンの準備



インジケーターでQRコードを読み取る
赤色でゆっくり点滅する

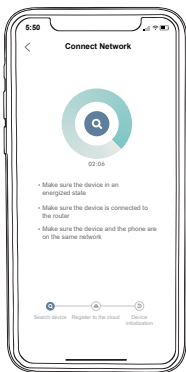

インストール完了
100%達成時

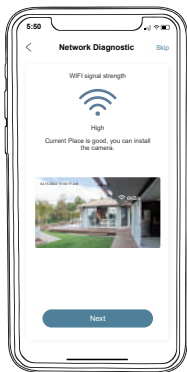

ネットワーク診断の実施

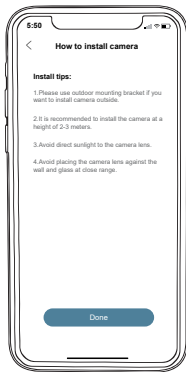

インストール方法を見る

ZUMIMALL™

(Old Version)

ZUMiMALL™

(New Version)

FCC ID: 2AZL7-ZS-GX1S



ZUMIMALL Logo Change Info